



US00D402419S

United States Patent [19] Sauriol

[11] **Patent Number: Des. 402,419**

[45] **Date of Patent: **Dec. 8, 1998**

[54] **PROTECTIVE GLOVE**

[75] Inventor: **Claude Sauriol**, Laval, Canada

[73] Assignee: **Bauer**, Canada

[**] Term: **14 Years**

[21] Appl. No.: **75,368**

[22] Filed: **Jul. 15, 1997**

[30] **Foreign Application Priority Data**

May 6, 1997 [CA] Canada 1997-1119

[51] **LOC (6) Cl.** **29-02**

[52] **U.S. Cl.** **D29/117**

[58] **Field of Search** D29/113, 117,
D29/118, 122-123; D2/617, 619; 2/16,
160, 161.1-161.5, 161.7, 162, 163, 168

[56] **References Cited**

U.S. PATENT DOCUMENTS

- D. 322,845 12/1991 Johnston D29/22
- D. 346,046 4/1994 Guilbault D29/22
- D. 376,676 12/1996 Chen D29/117
- D. 379,677 6/1997 Castonguay D29/117
- D. 387,505 12/1997 Clement D29/117
- D. 388,908 11/1996 Shikatani D29/117
- 4,677,698 7/1987 Angas 2/161 A
- 5,488,739 2/1996 Cardinal 2/161.1
- 5,511,243 4/1996 Hall et al. 2/16

Primary Examiner—Ruth McInroy

Attorney, Agent, or Firm—Finnegan, Henderson, Farabow, Garrett & Dunner, L.L.P.

[57] **CLAIM**

The ornamental design for a protective glove, as shown and described.

DESCRIPTION

FIG. 1 is a perspective view of the first embodiment of the protective glove for a right hand embodying my design, the protective glove for the left hand being a mirror image thereof;

FIG. 2 is another perspective view thereof;

FIG. 3 is a top plan view thereof;

FIG. 4 is a front elevational view thereof;

FIG. 5 is a rear elevational view thereof;

FIG. 6 is a left side view thereof;

FIG. 7 is a right side view thereof;

FIG. 8 is a bottom plan view thereof;

FIG. 9 is a perspective view of the second embodiment of the protective glove for a right hand embodying my design, the protective glove for the left hand being a mirror image thereof;

FIG. 10 is another perspective view thereof;

FIG. 11 is a top plan view thereof;

FIG. 12 is a front elevational view thereof;

FIG. 13 is a rear elevational view thereof;

FIG. 14 is a left side view thereof;

FIG. 15 is a right side view thereof; and,

FIG. 16 is a bottom plan view thereof.

1 Claim, 6 Drawing Sheets

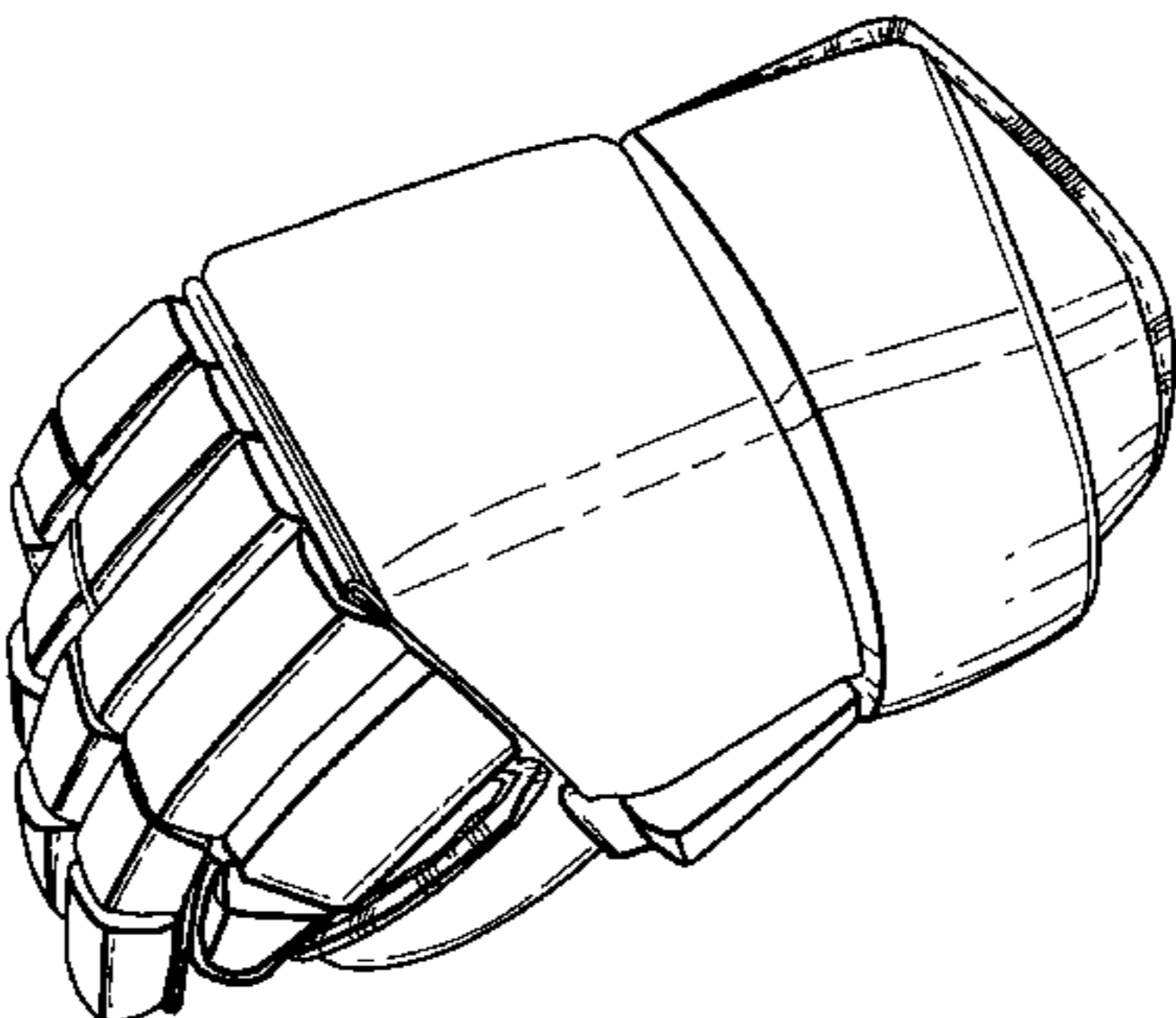
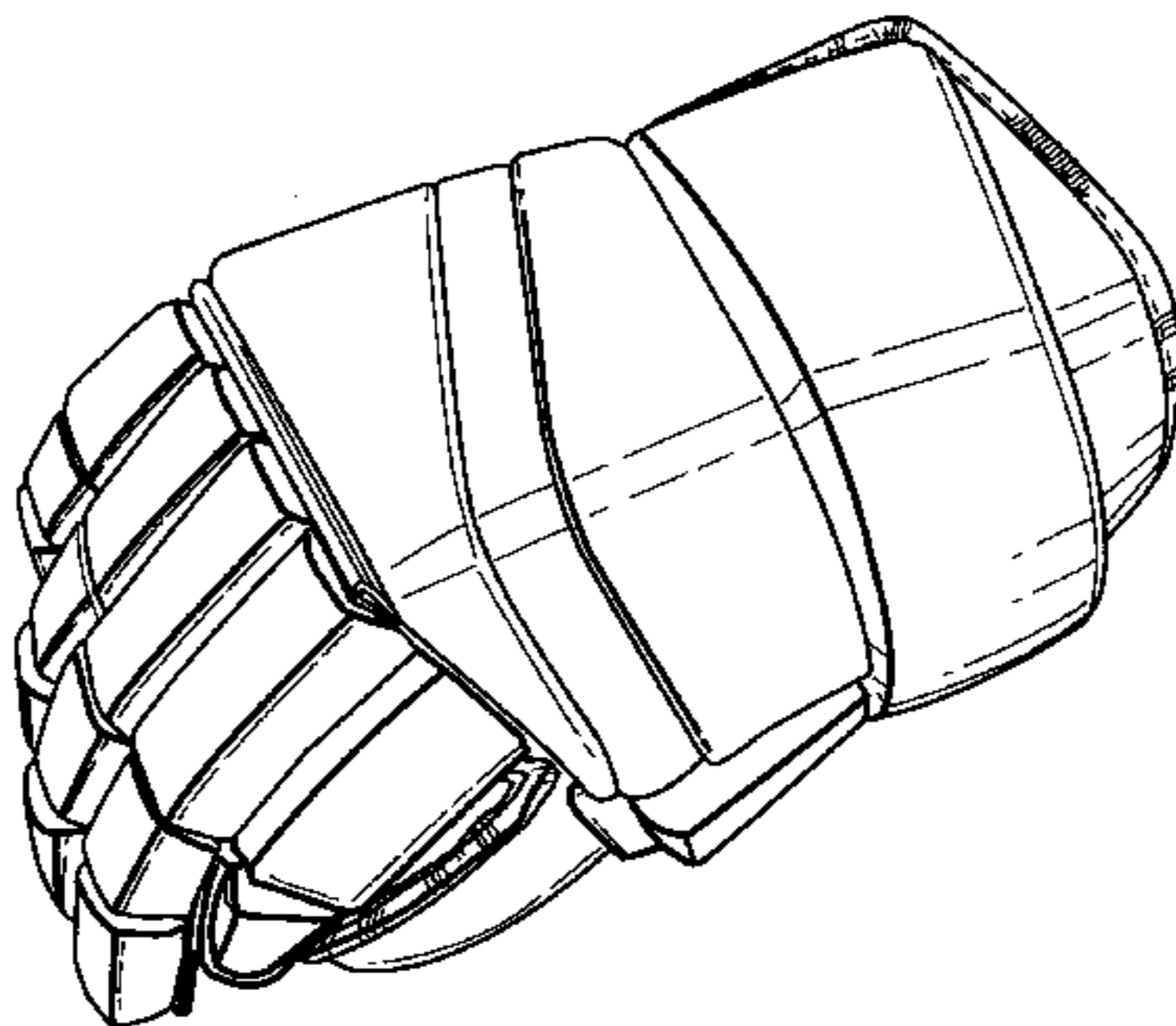

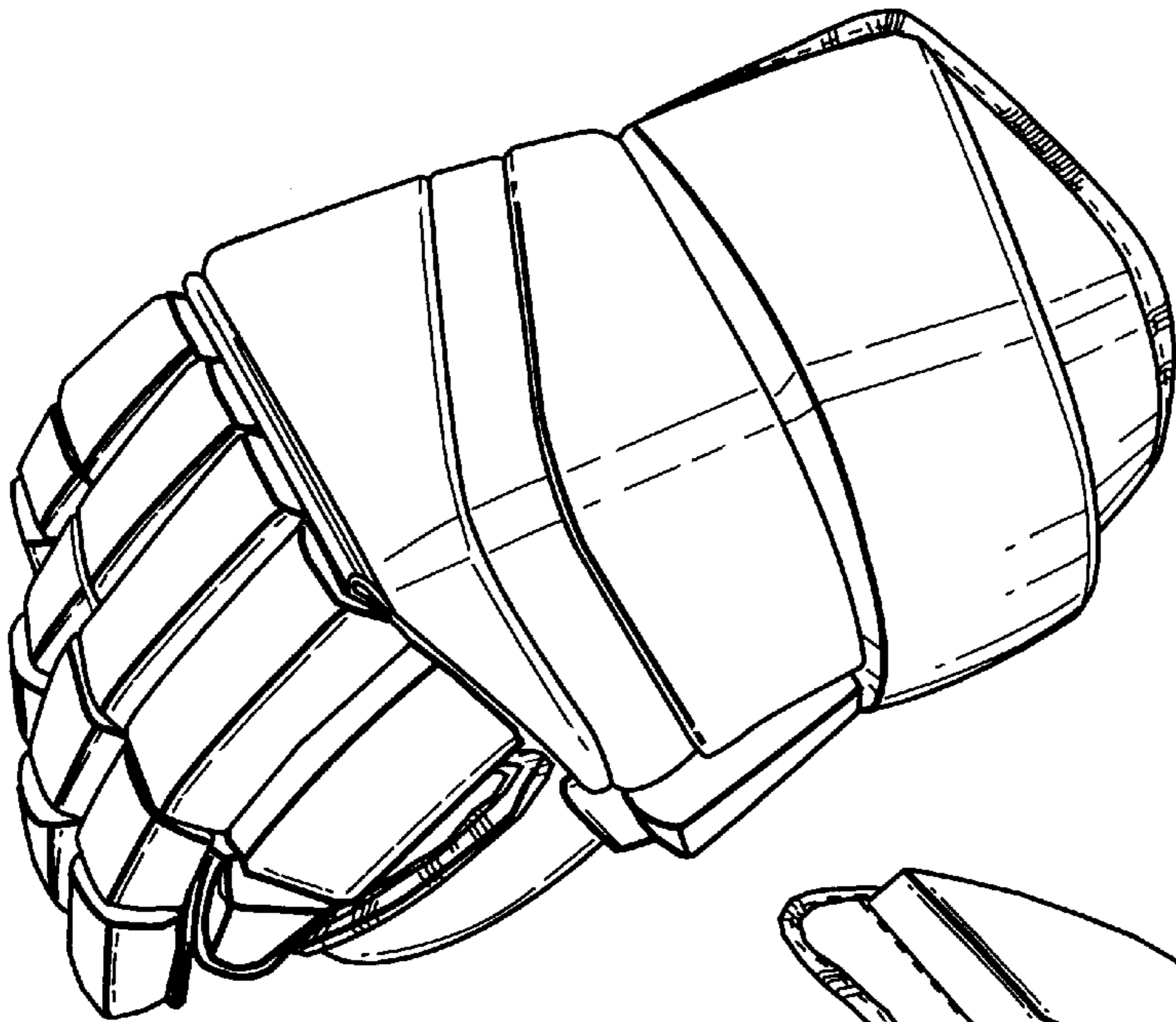

Fig. 1

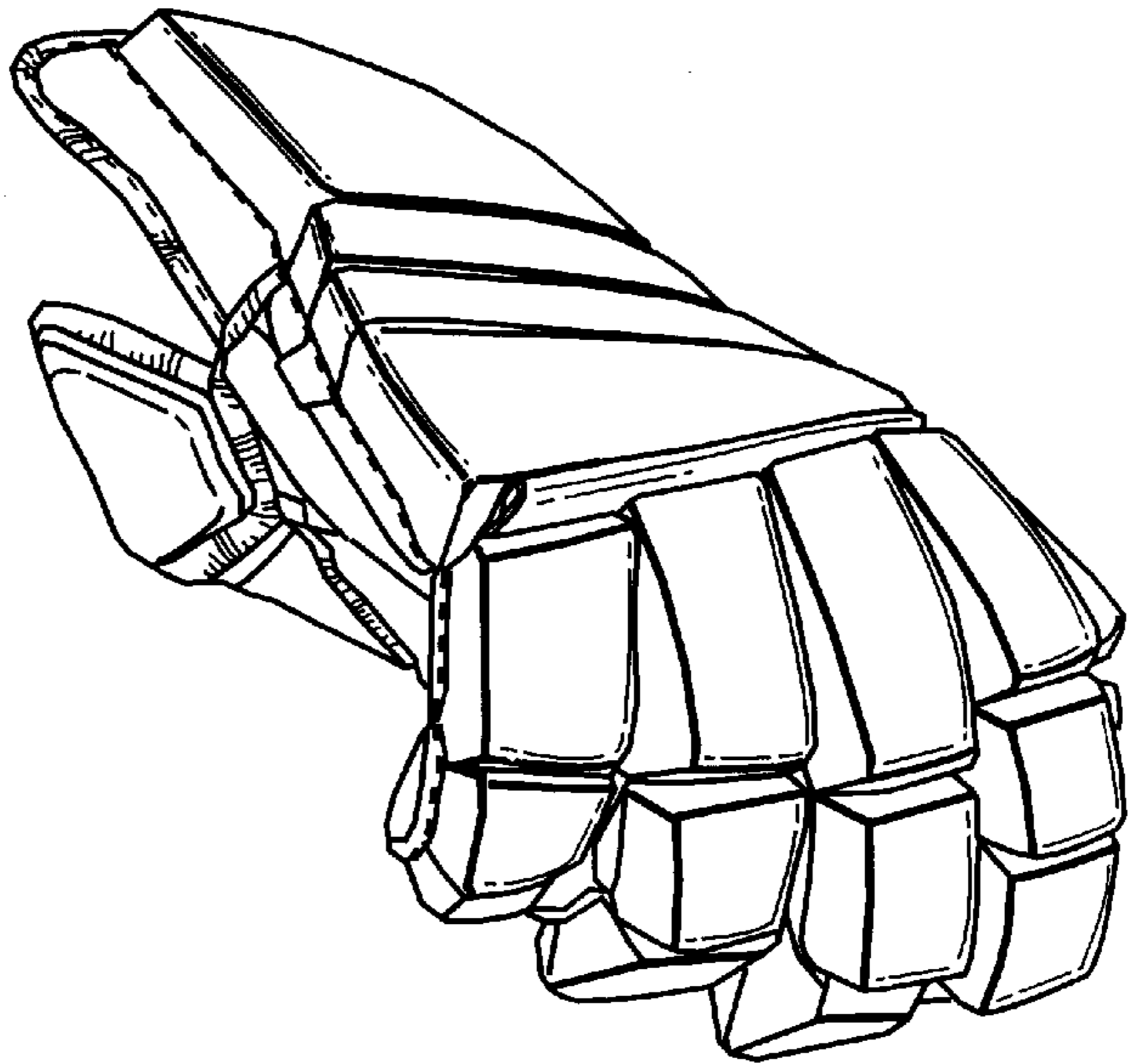

Fig. 2

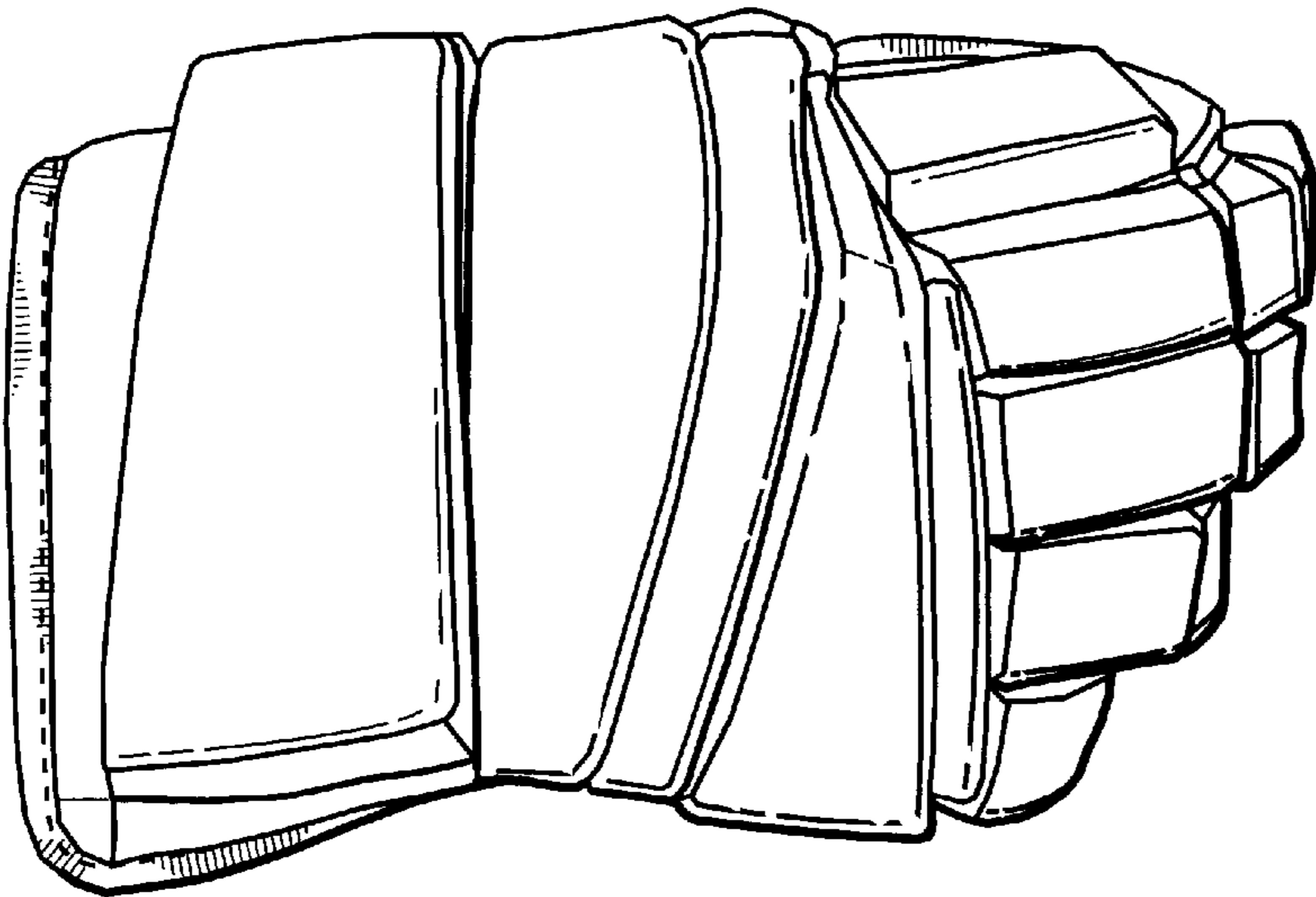

Fig. 3

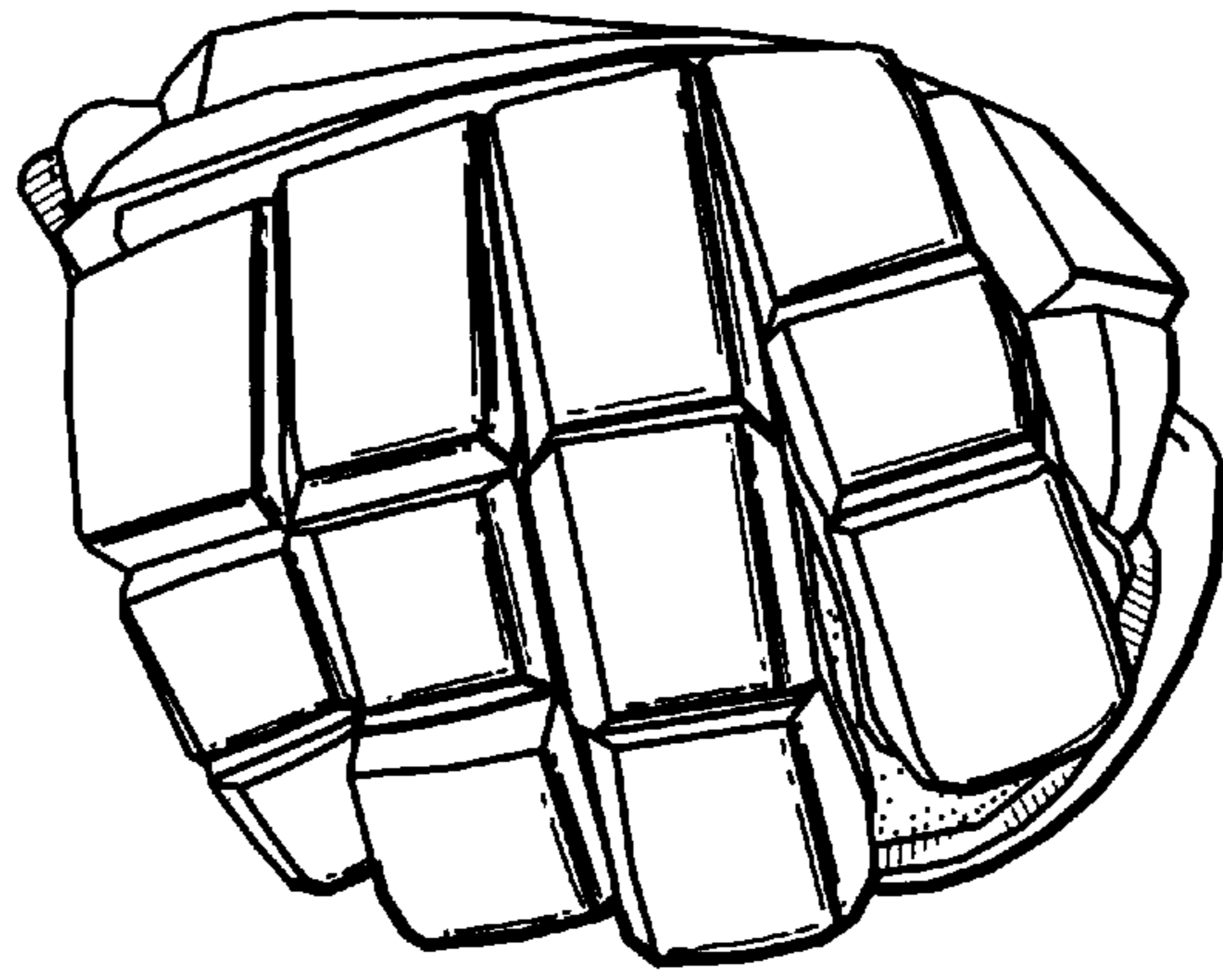

Fig.4

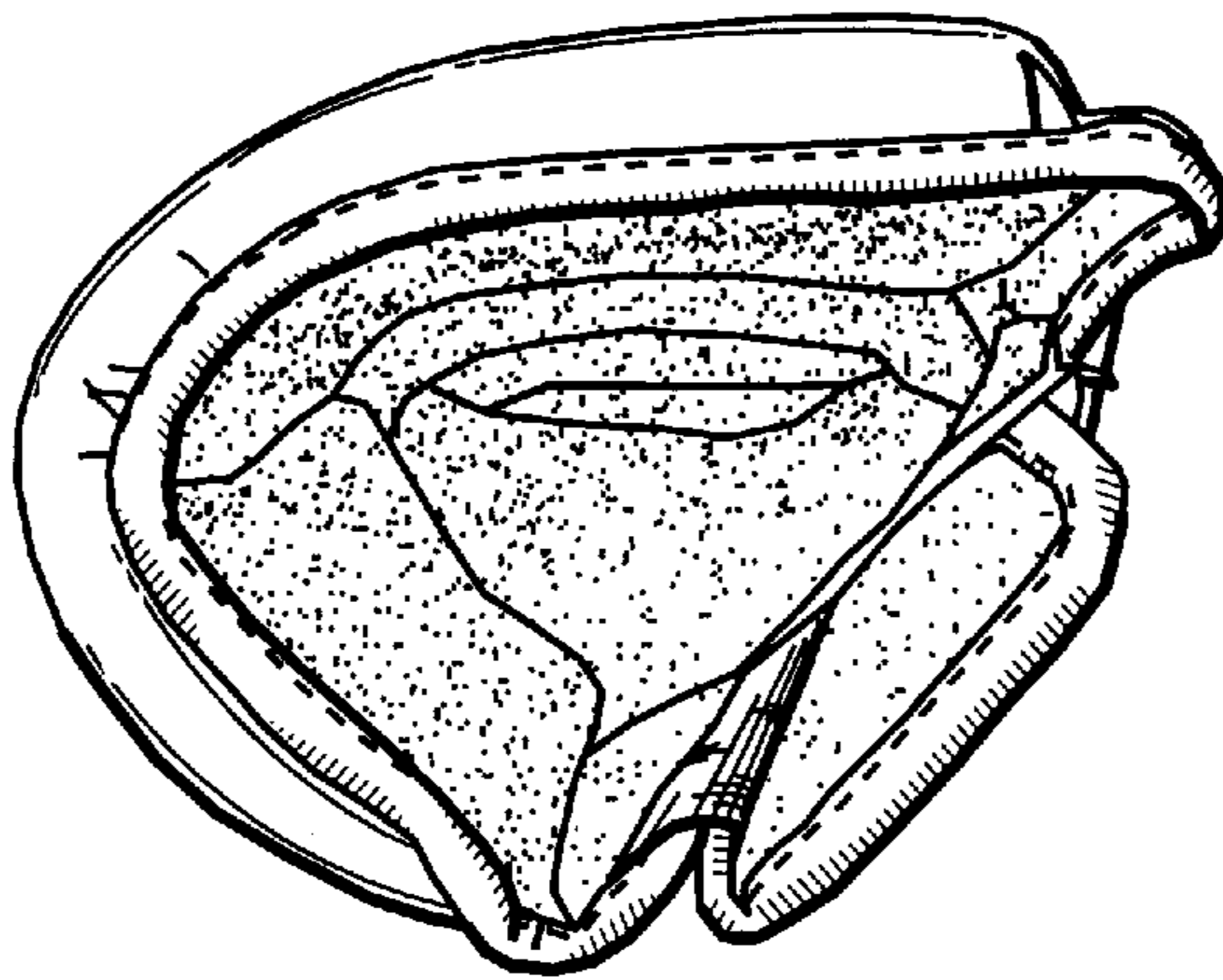

Fig.5

Fig.6

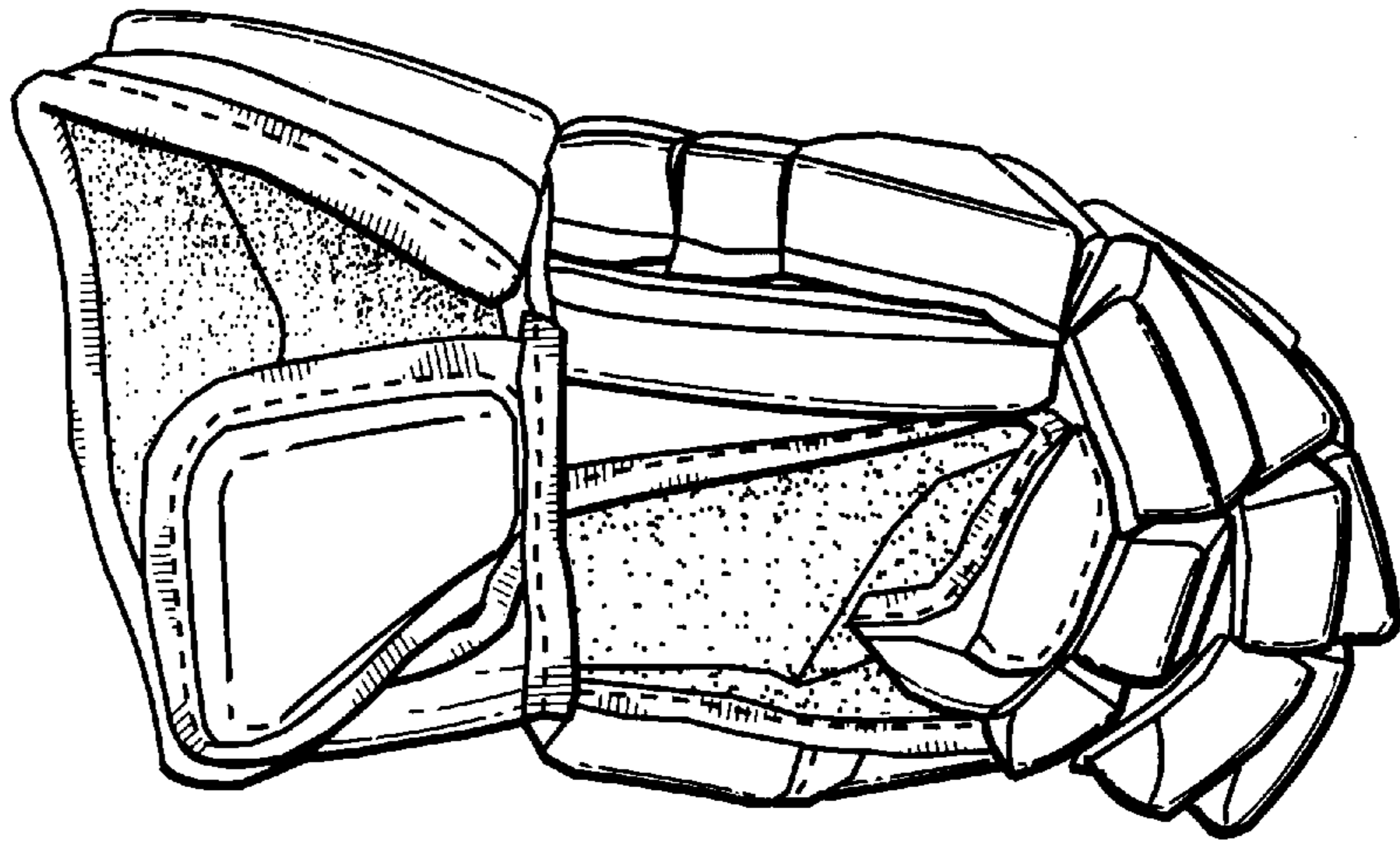

Fig.8

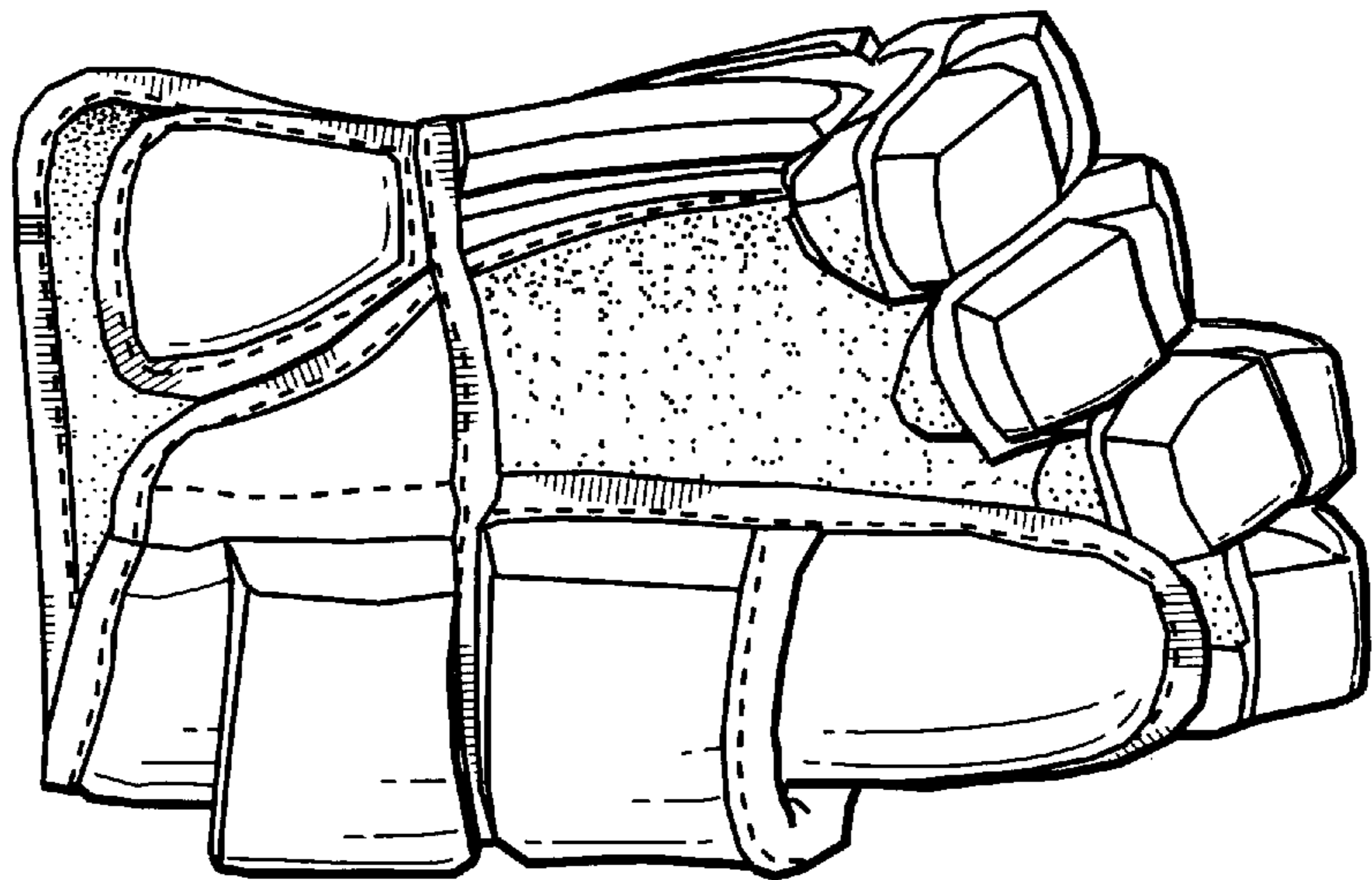
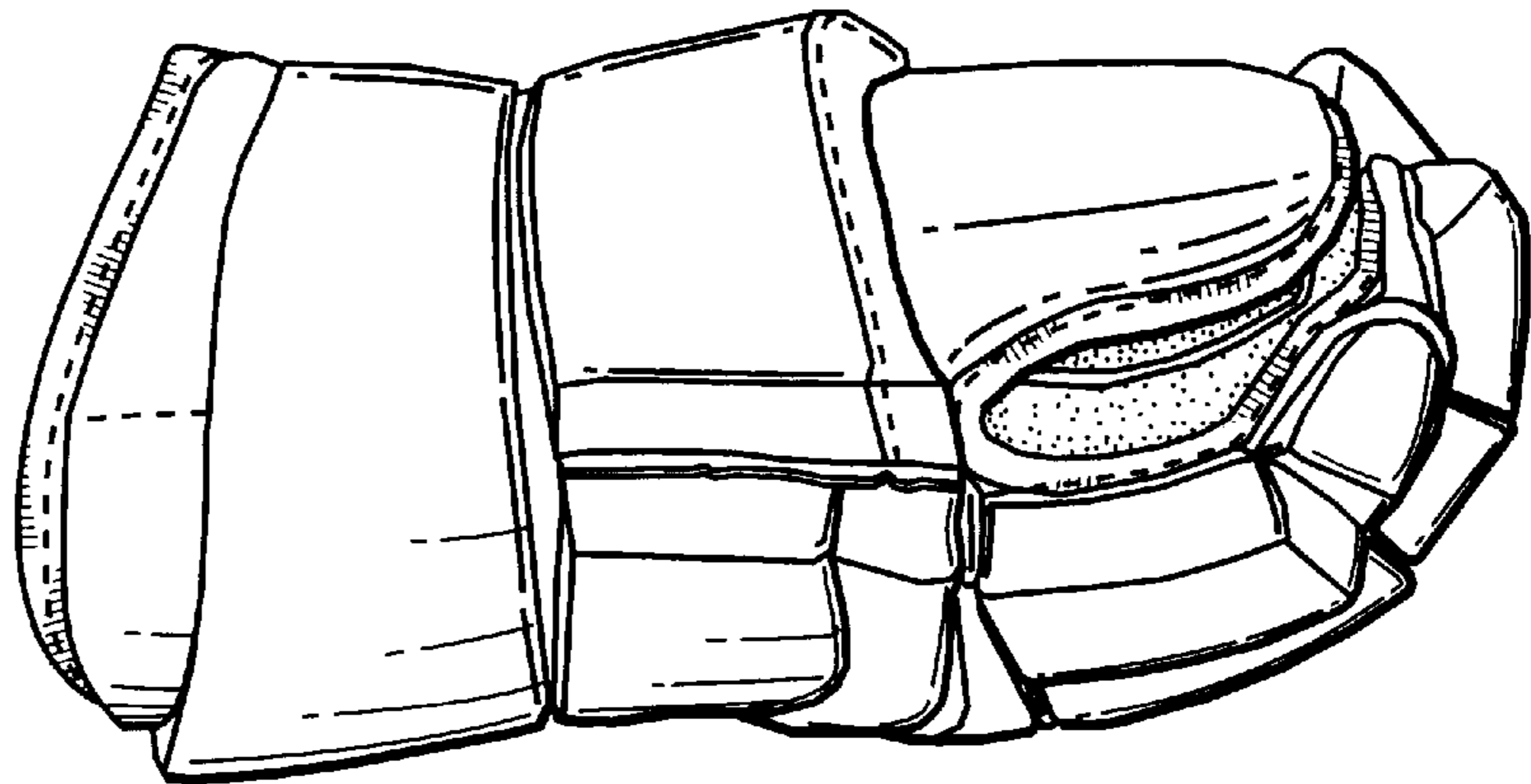

Fig.7



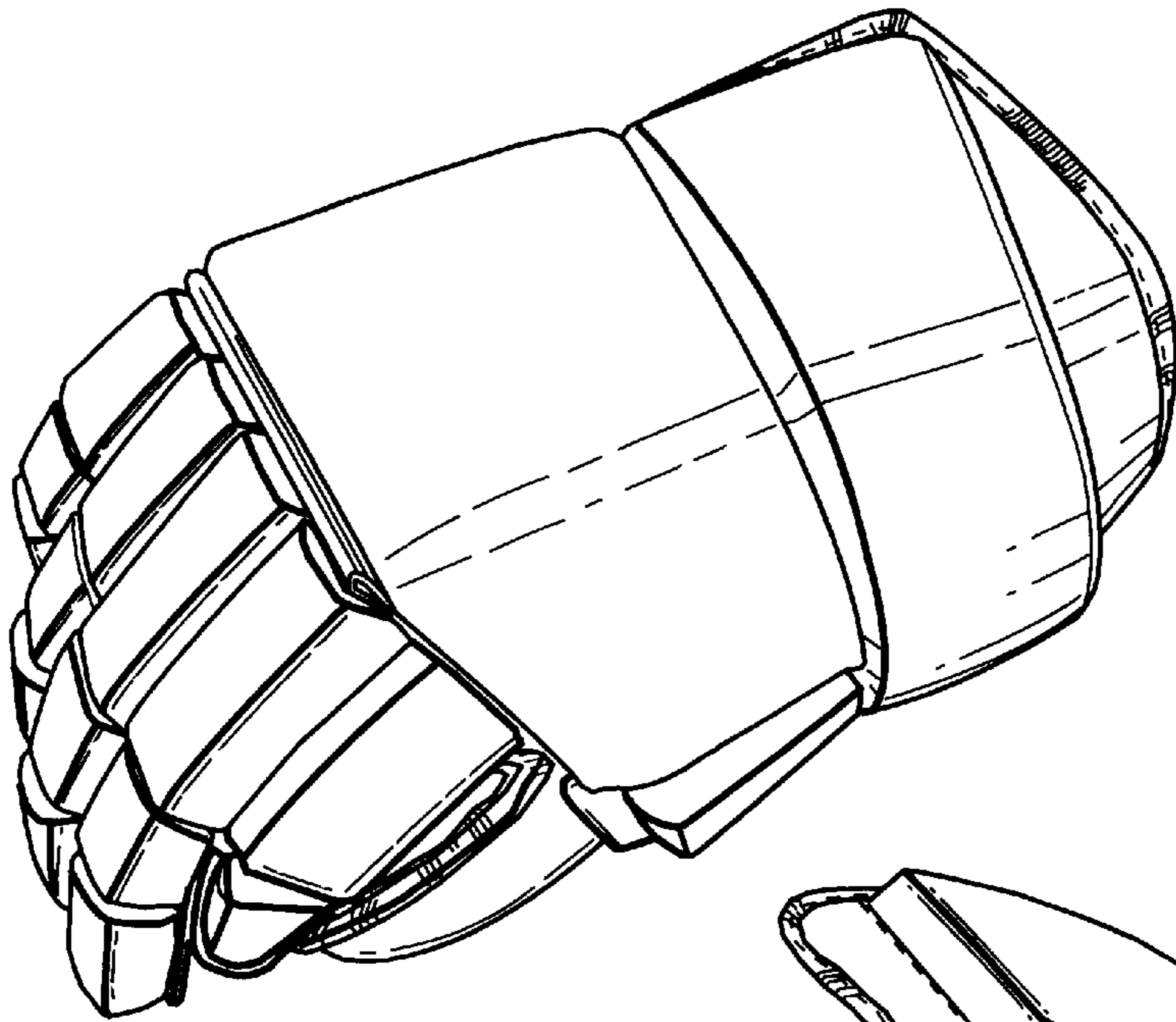

Fig.9

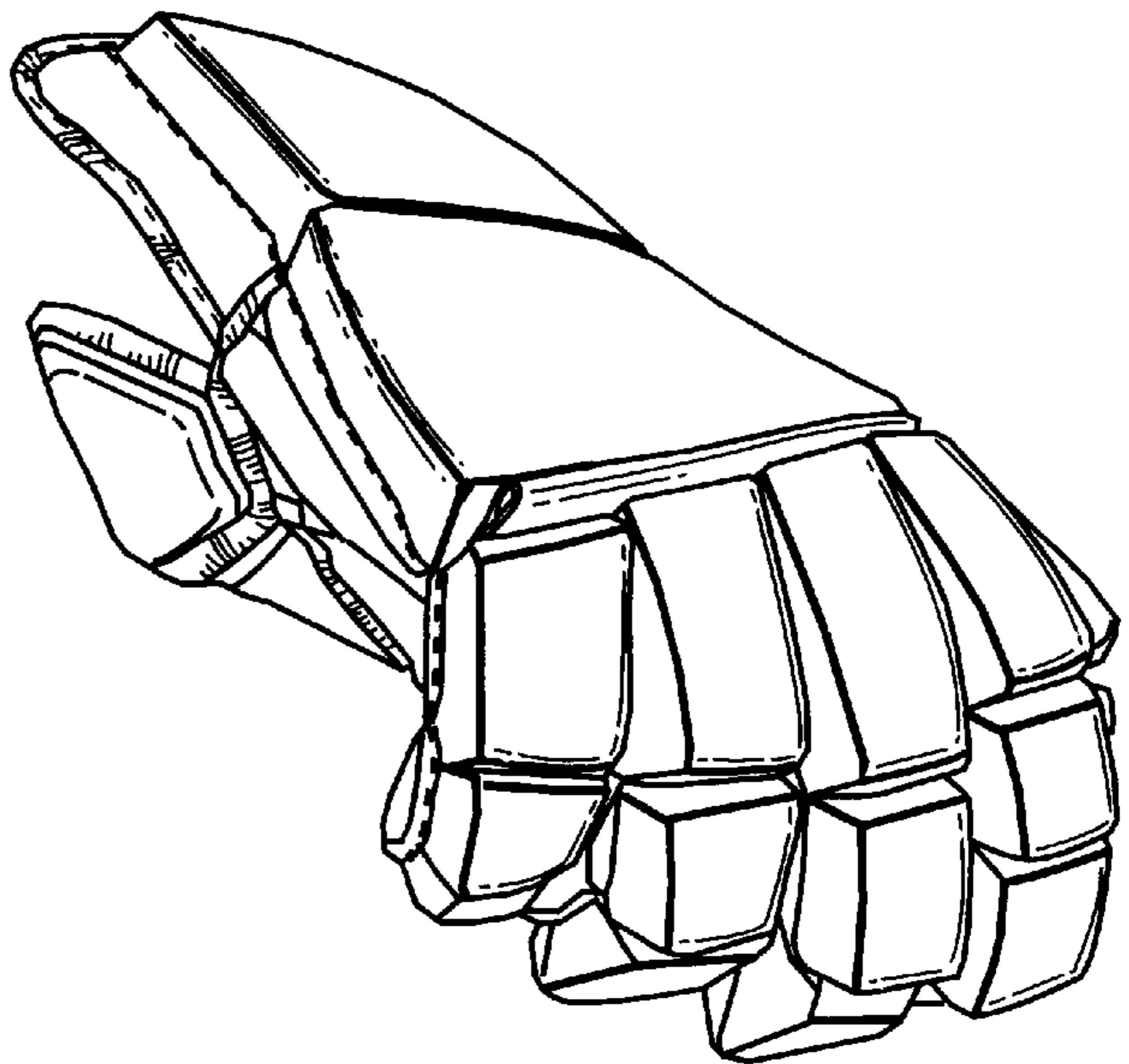

Fig.10

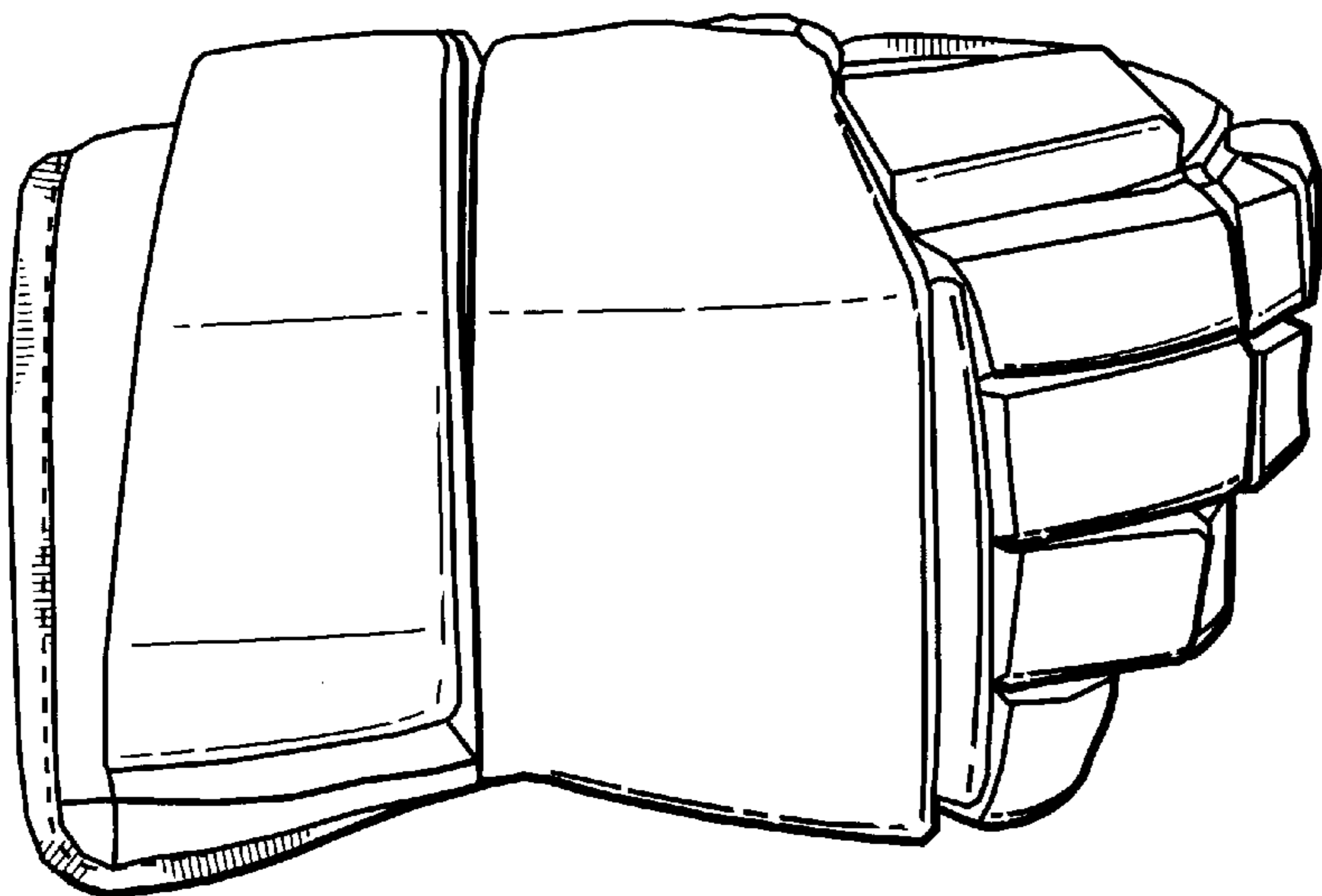

Fig.11

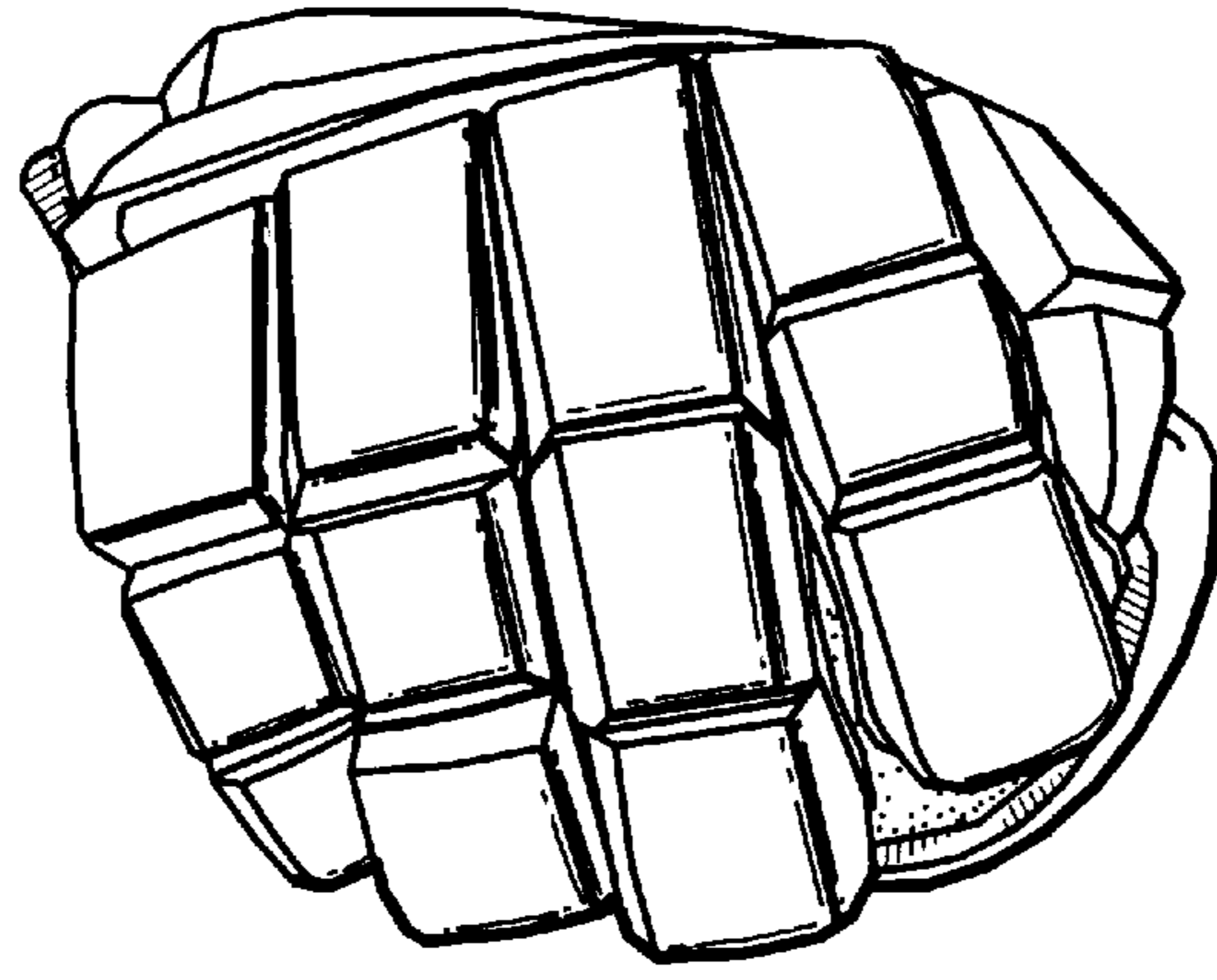

Fig.12

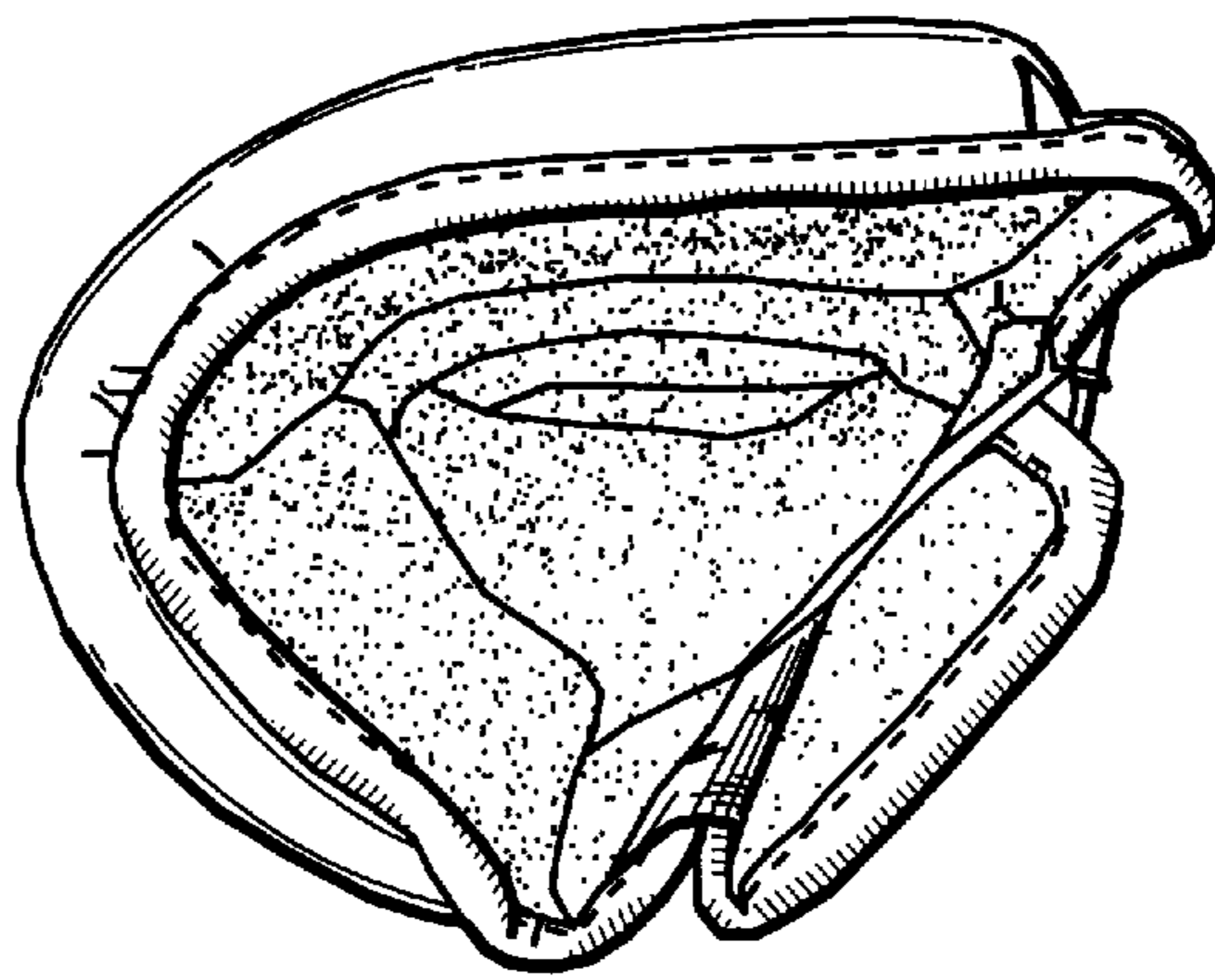

Fig.13

Fig.14

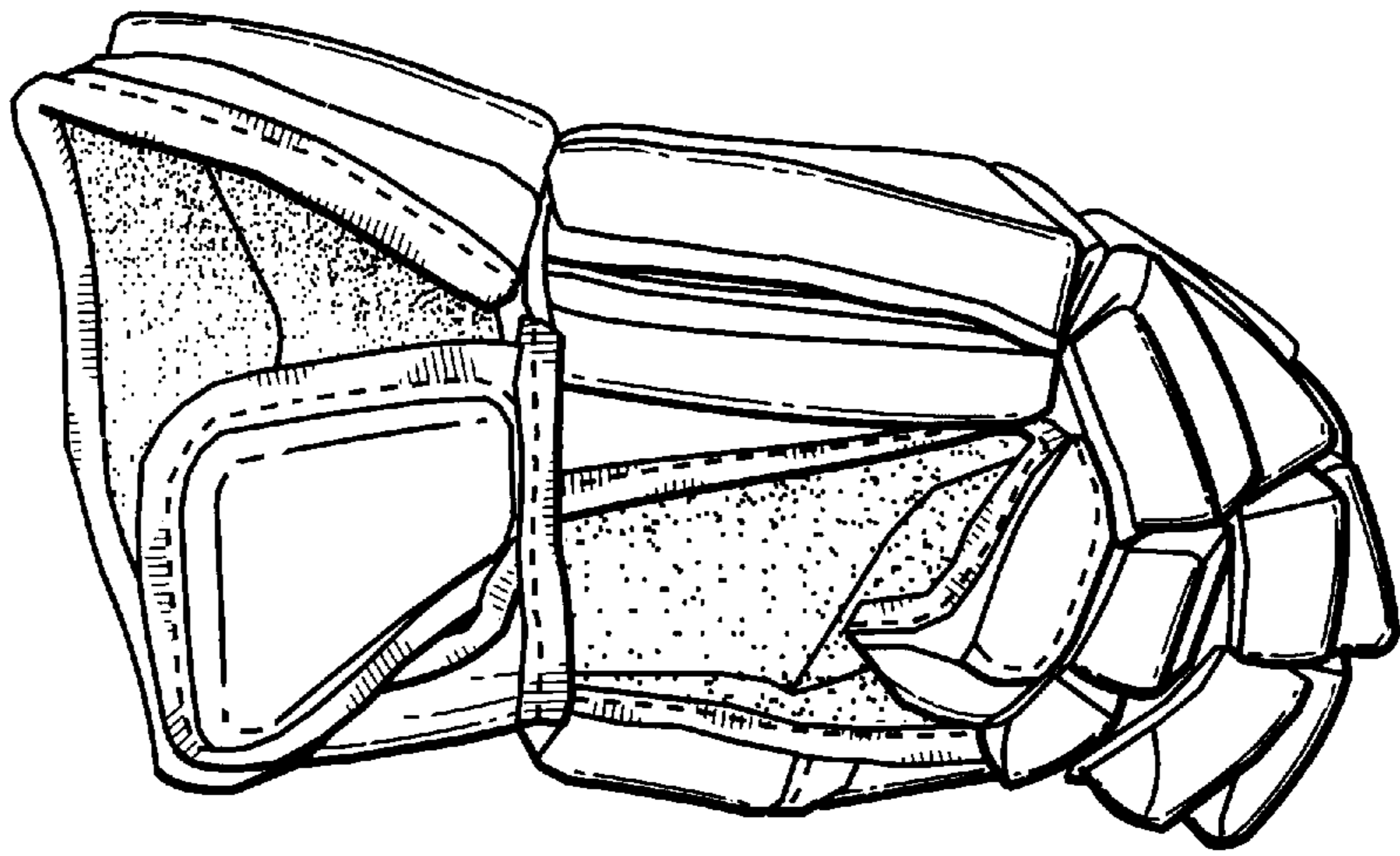

Fig.16

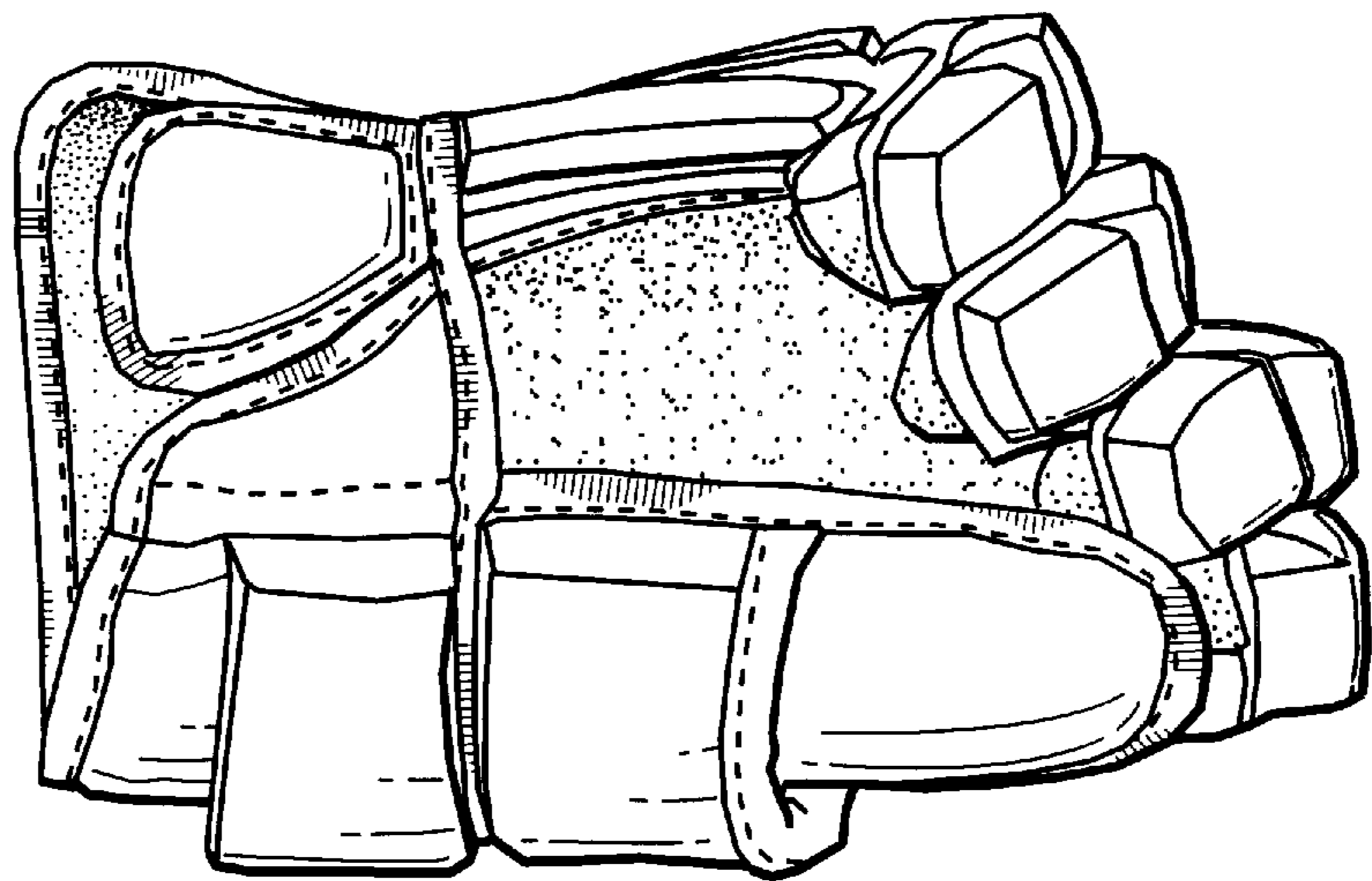
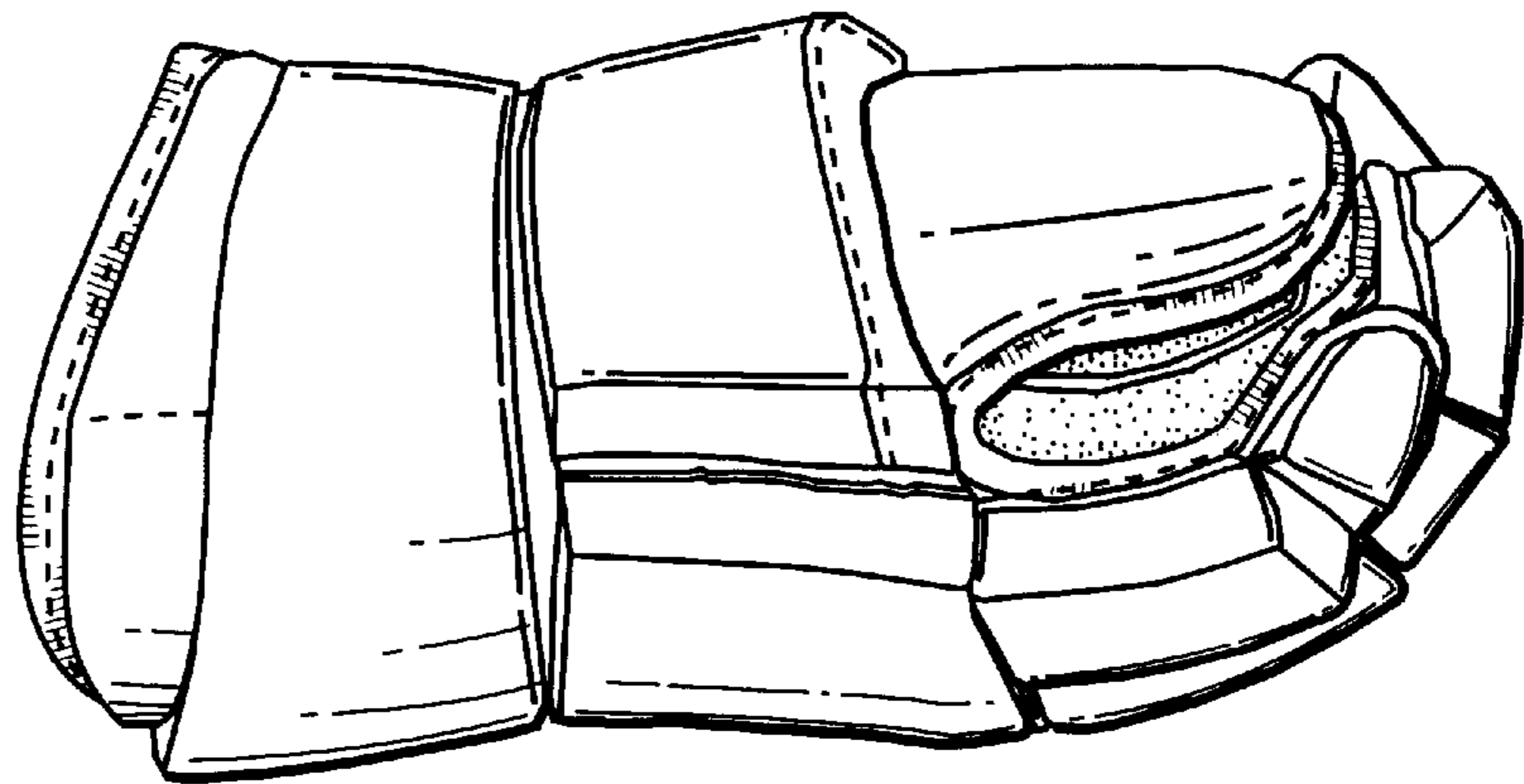

Fig.15



UNITED STATES PATENT AND TRADEMARK OFFICE
CERTIFICATE OF CORRECTION

PATENT NO. : Des. 402,419
DATED : December 8, 1998
INVENTOR(S) : Claude Sauriol

It is certified that error appears in the above-identified patent and that said Letters Patent is hereby corrected as shown below:

Title page, item [30] Foreign Application Priority Data, delete "May 6, 1997" and replace with --May 2, 1997--; and

Signed and Sealed this
Eighth Day of February, 2000

Attest:



Q. TODD DICKINSON

Attesting Officer

Commissioner of Patents and Trademarks