



US00D402378S

**United States Patent** [19]  
**Parkhurst**

[11] **Patent Number: Des. 402,378**

[45] **Date of Patent: \*\*Dec. 8, 1998**

[54] **GLASS DOOR WITH BRASS TRIM AND BEVELED FACETS**

[75] Inventor: **John M. Parkhurst**, Minnetonka, Minn.

[73] Assignee: **Cole Sewell Corporation**, St. Paul, Minn.

[\*\*] Term: **14 Years**

[21] Appl. No.: **53,733**

[22] Filed: **Apr. 29, 1996**

[51] **LOC (6) Cl. .... 25-01**

[52] **U.S. Cl. .... D25/103**

[58] **Field of Search .... D25/48, 103-110; 52/311.1, 456; 428/38; 49/501, 504; 160/237**

[56] **References Cited**

**U.S. PATENT DOCUMENTS**

D. 265,933	8/1982	Simpson	.....	D25/103
D. 349,352	8/1994	Osati	.....	D25/103
D. 357,083	4/1995	Underdahl	.....	D25/138
D. 361,137	8/1995	Parkhurst	.....	D25/103
D. 367,328	2/1996	Hszewski	.....	D25/103
5,003,745	4/1991	Fang	.....	52/311.1
5,022,206	6/1991	Schild et al.	.....	52/456
5,418,021	5/1995	Kim	.....	428/38

**OTHER PUBLICATIONS**

Sweet's Catalog, '93 and '94.

*Primary Examiner*—Raphael Barkai  
*Attorney, Agent, or Firm*—Mau & Krull, P.A.

[57] **CLAIM**

The ornamental design for glass door with brass trim and beveled facets, as shown and described.

**DESCRIPTION**

FIG. 1 is a perspective view of a full view glass door with brass trim and beveled facets showing my new design;  
 FIG. 2 is a front plan view thereof;  
 FIG. 3 is a right side elevational view, the left side elevational view being a mirror image thereof;  
 FIG. 4 is a bottom plan view, the top plan view being a mirror image thereof;  
 FIG. 5 is a rear elevational view thereof;  
 FIG. 6 is an enlarged side elevational view taken generally along the lines 6—6 of FIG. 2;  
 FIG. 7 is an enlarged fragmentary top plan view of a portion of FIG. 1;  
 FIG. 8 is a perspective mid view of a mid view glass door with brass trim and beveled facets showing my new design;  
 FIG. 9 is a front plan view thereof;  
 FIG. 10 is the right side elevational view, the left side elevational view being a mirror image thereof;  
 FIG. 11 is a bottom plan view, the top plan view being a mirror image thereof;  
 FIG. 12 is a rear elevational view thereof;  
 FIG. 13 is an enlarged side elevational view taken generally along the lines 13—13 of FIG. 8;  
 FIG. 14 is an enlarged fragmentary top plan view of a portion of FIG. 8; and  
 FIG. 15 is a perspective view of a high view glass door with brass trim and beveled facets showing my new design;  
 FIG. 16 is a front plan view thereof;  
 FIG. 17 is the right side elevational view, the left side elevational view being a mirror image thereof;  
 FIG. 18 is a bottom plan view, the top plan view being a mirror image thereof;  
 FIG. 19 is a rear elevational view thereof;  
 FIG. 20 is an enlarged side elevational view taken generally along the lines 20—20 of FIG. 16; and  
 FIG. 21 is an enlarged fragmentary top plan view of a portion of FIG. 15.  
 The broken lines shown in FIGS. 1, 8 and 15 are for illustrative purposes only and form no part of the claimed design.

**1 Claim, 9 Drawing Sheets**

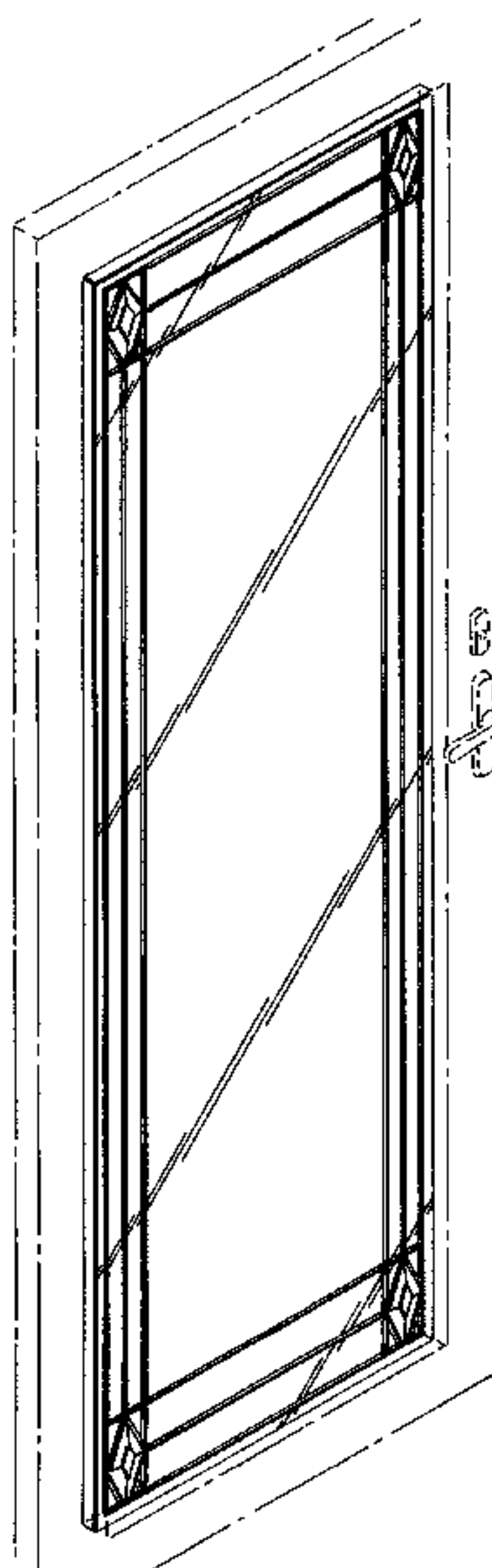

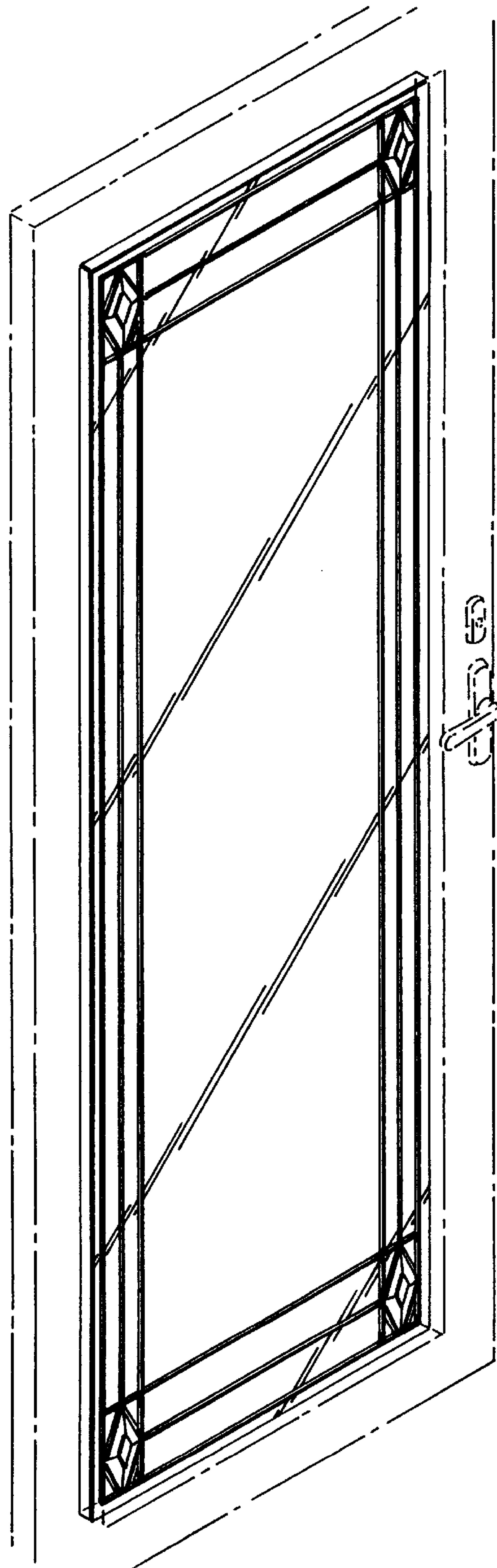

FIG.1

FIG.2

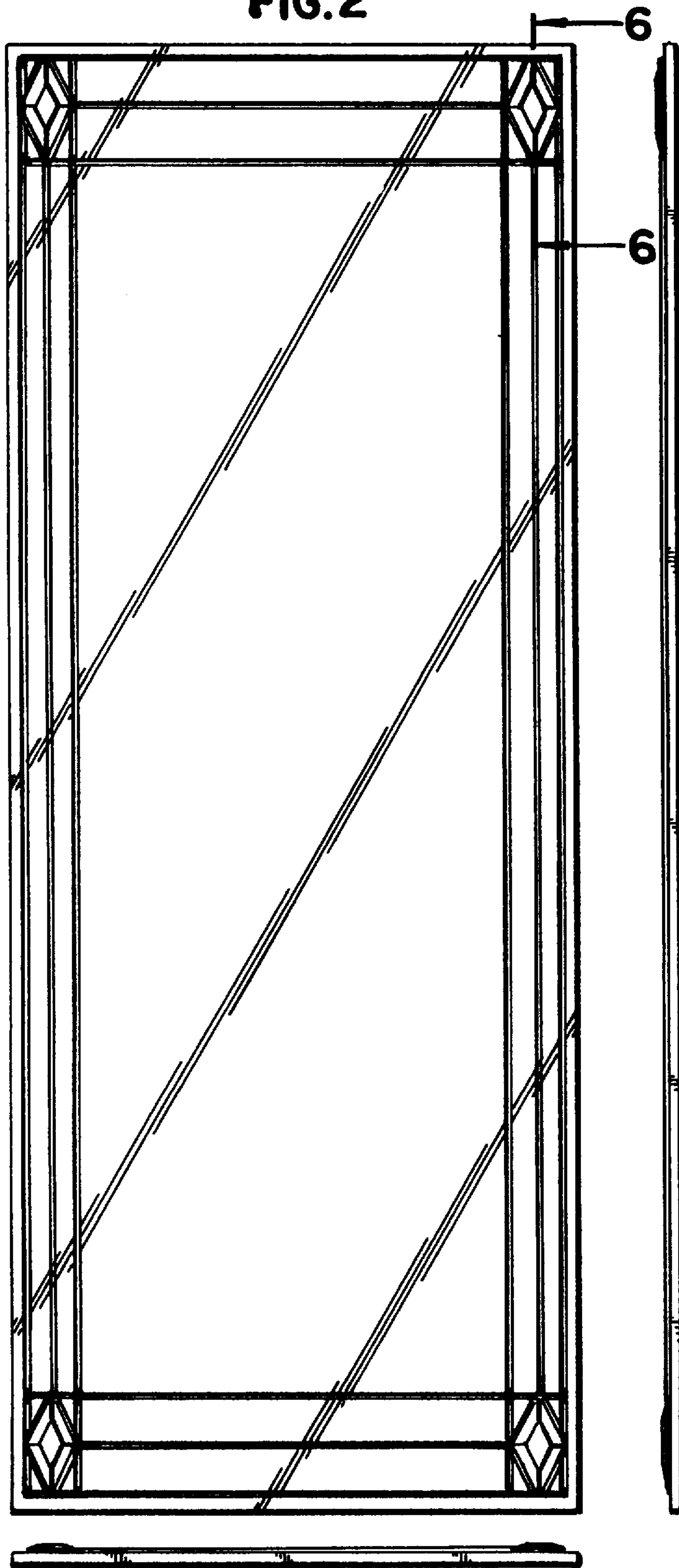

FIG.3

FIG.4

FIG. 5

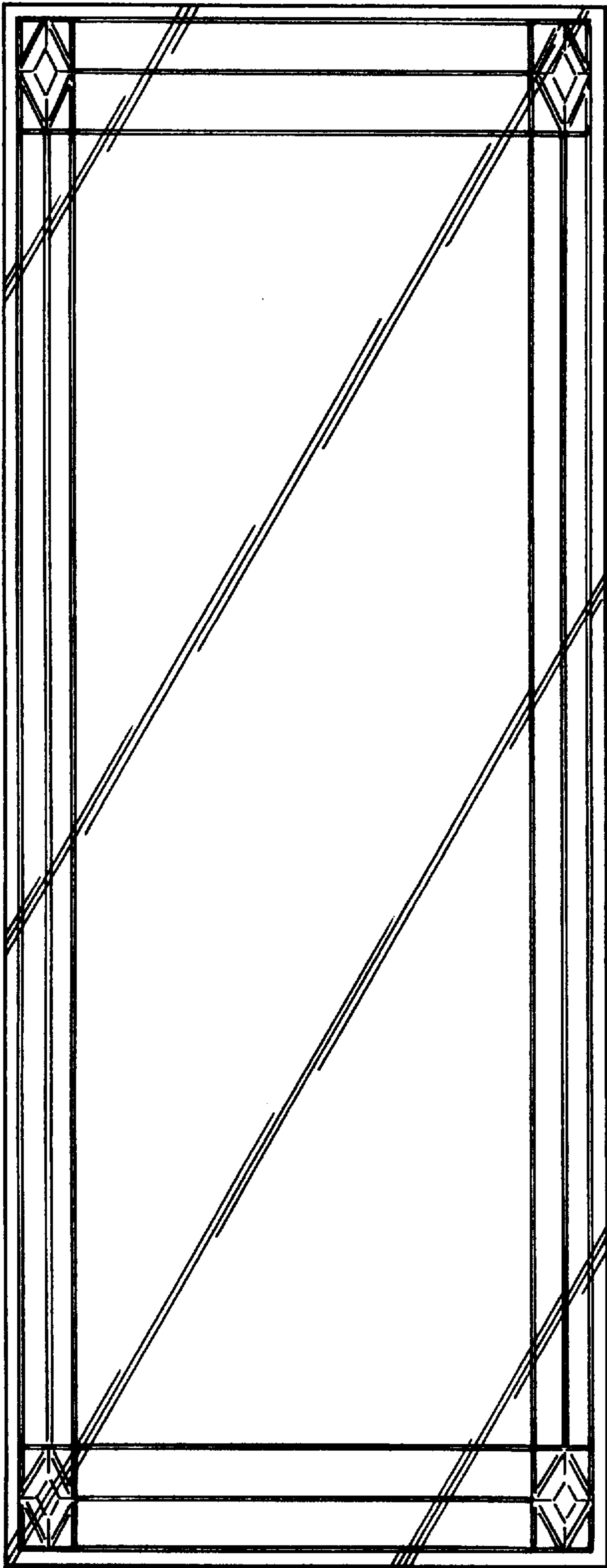

FIG. 6

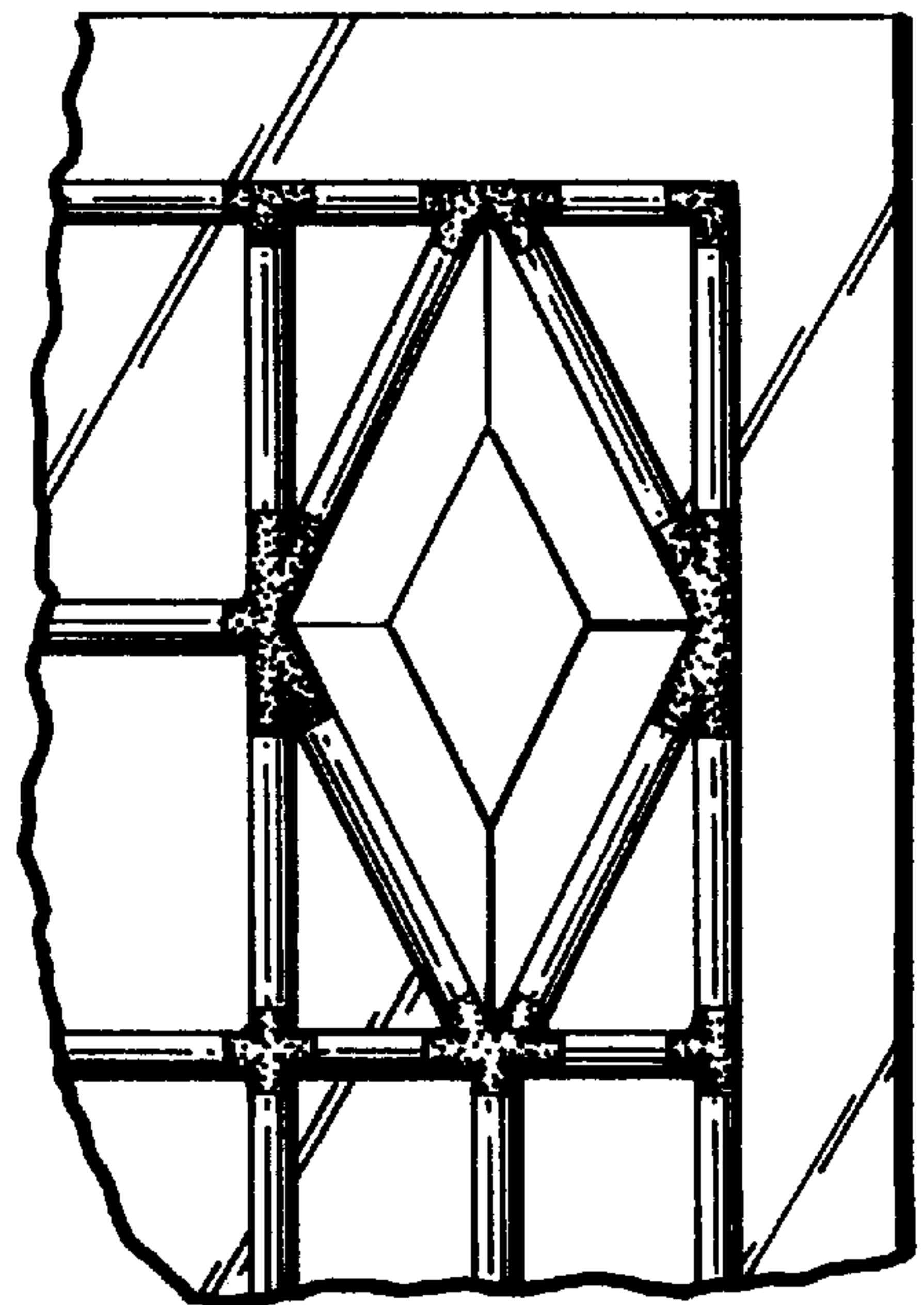
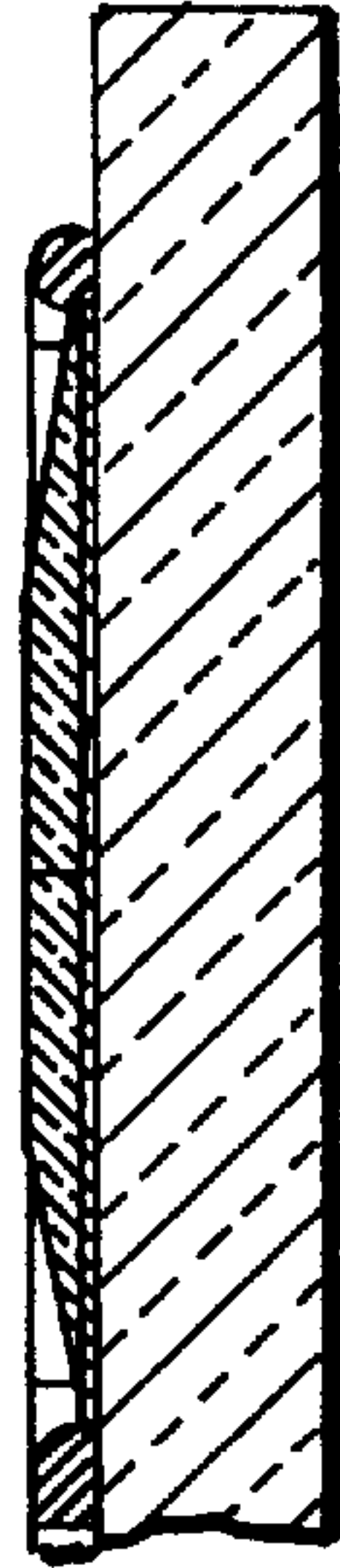

FIG. 7



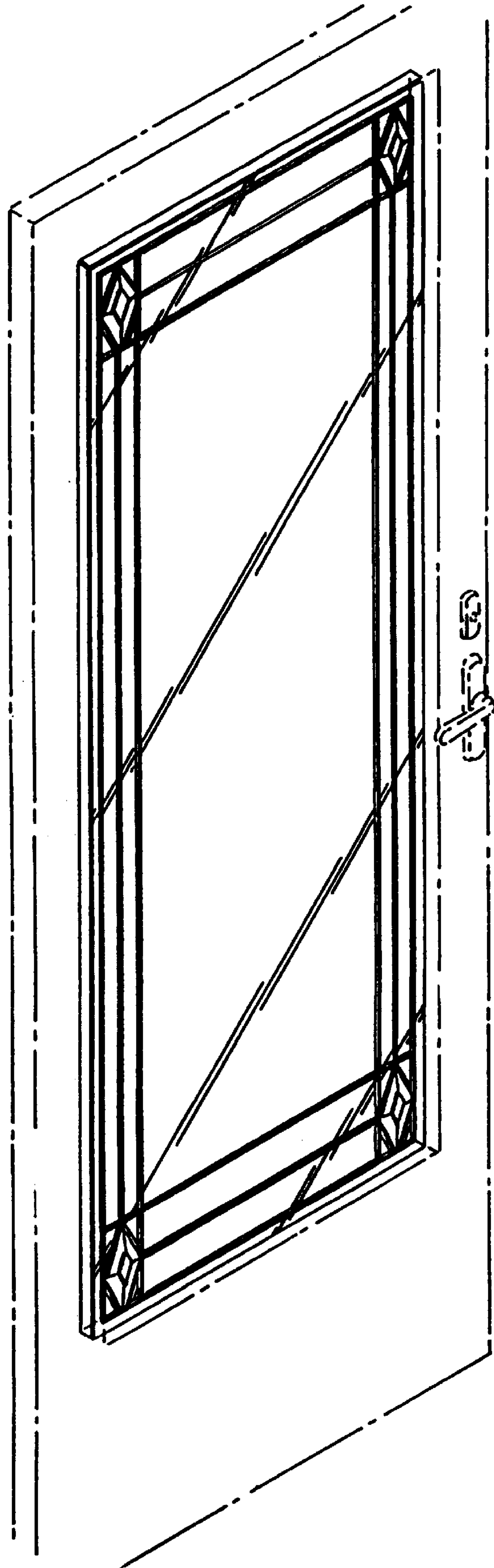

FIG. 8

FIG. 9

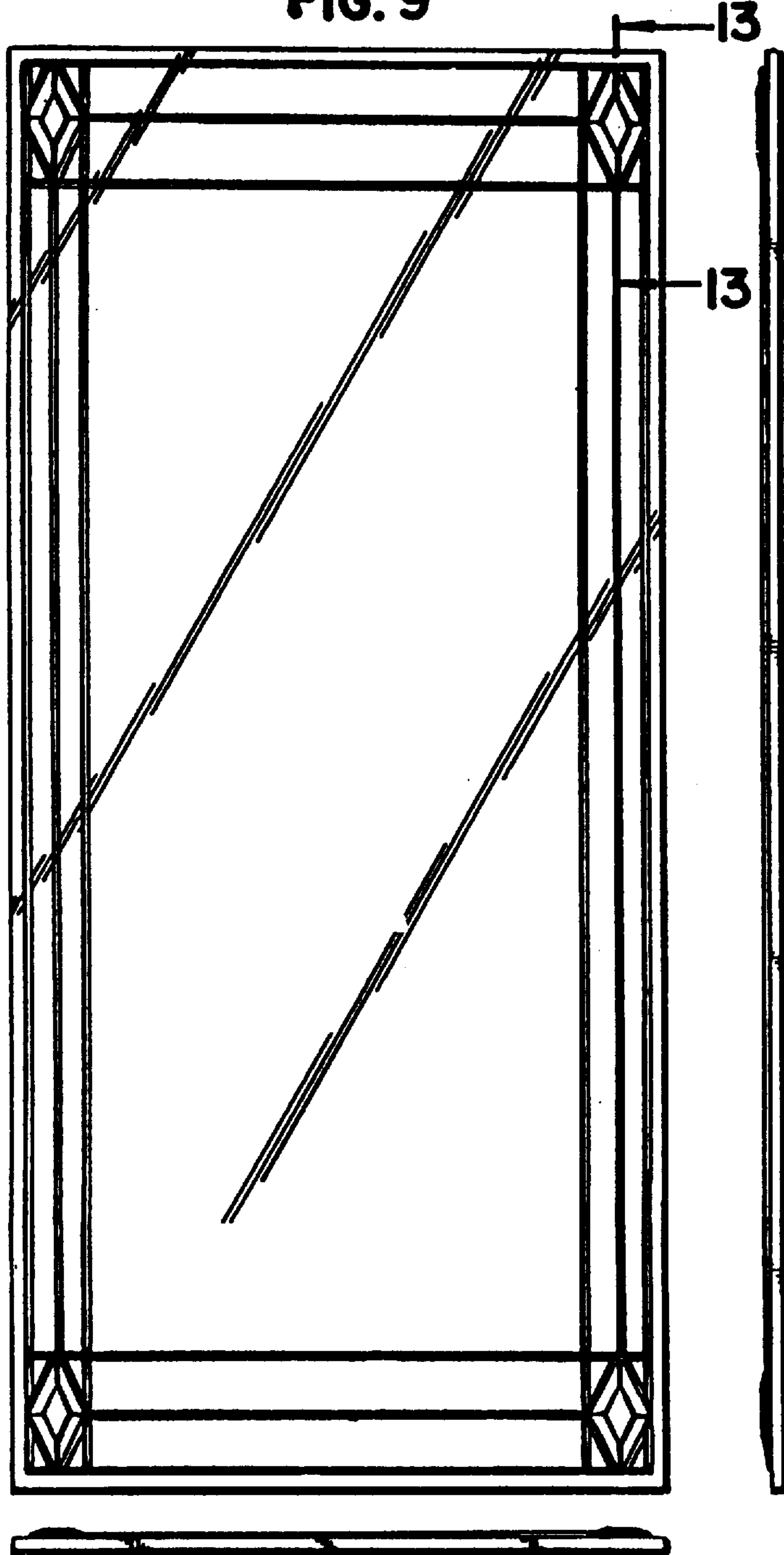

FIG. 10

FIG. II

FIG.12

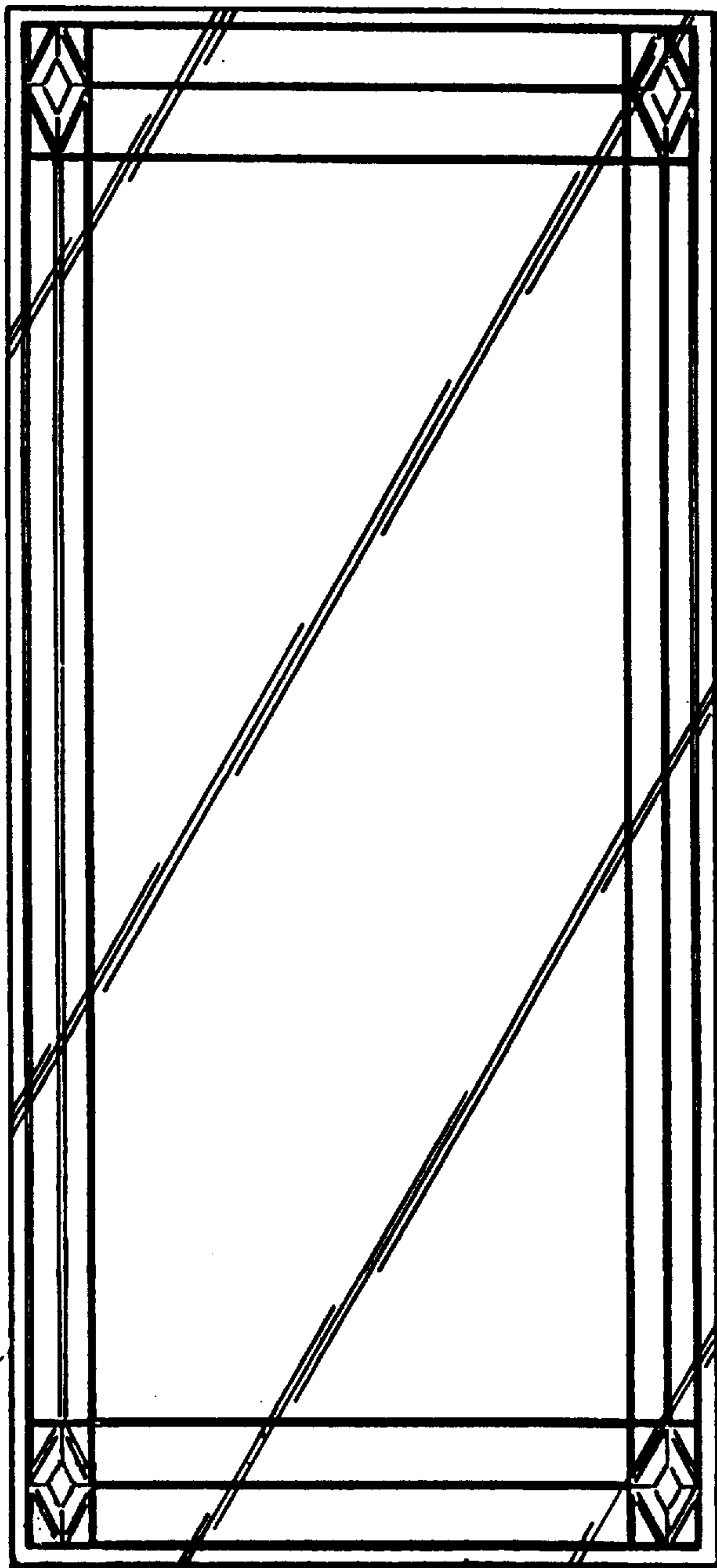

FIG.13

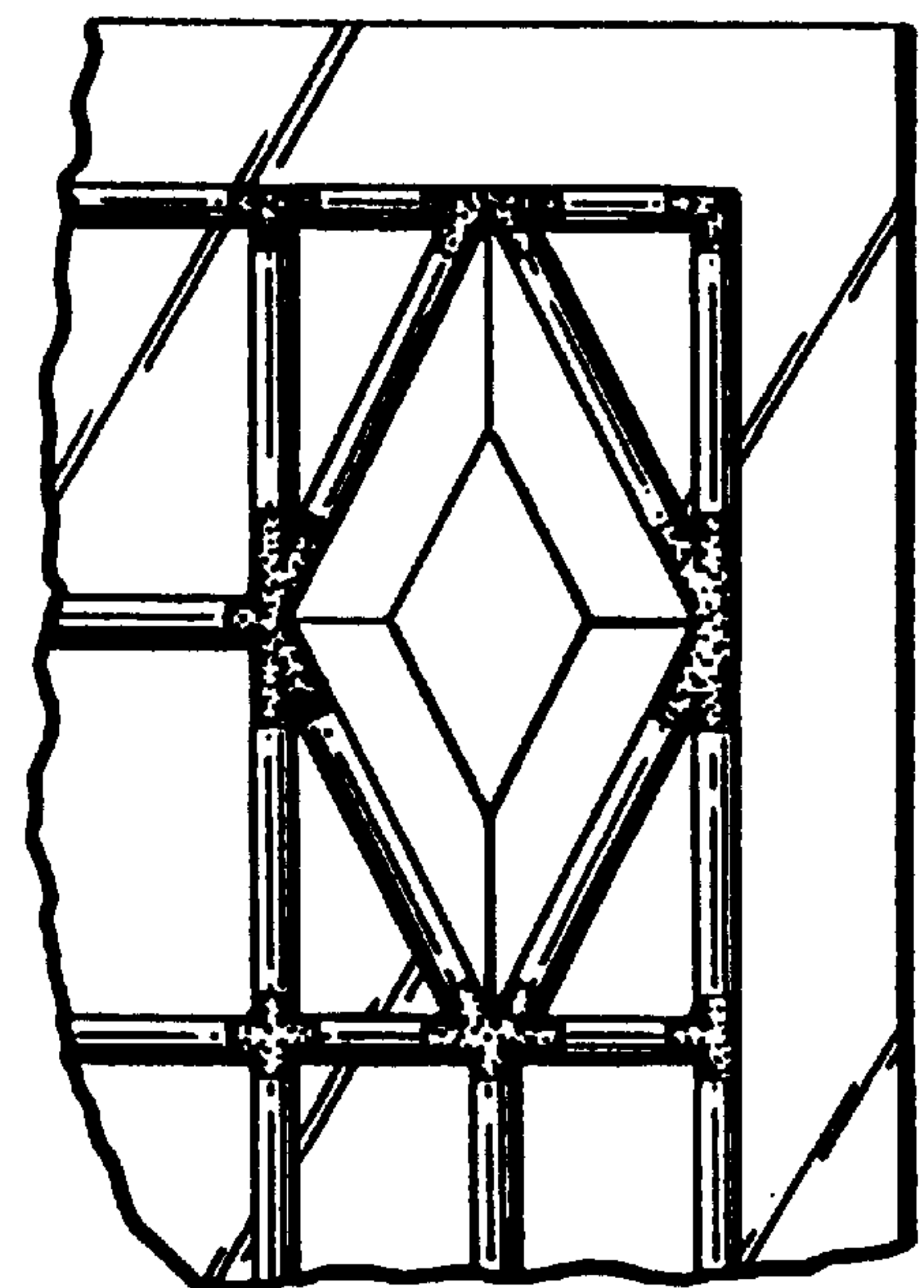
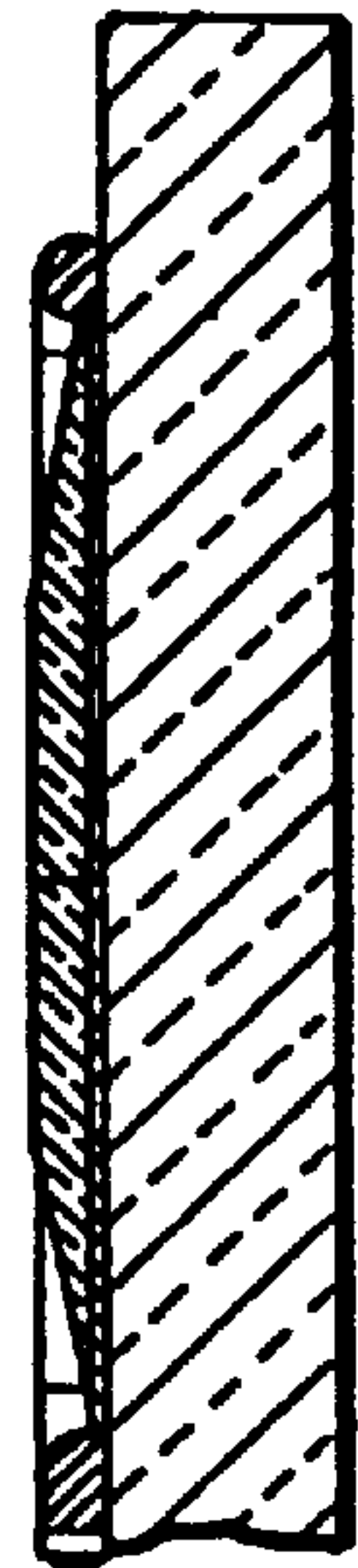

FIG.14

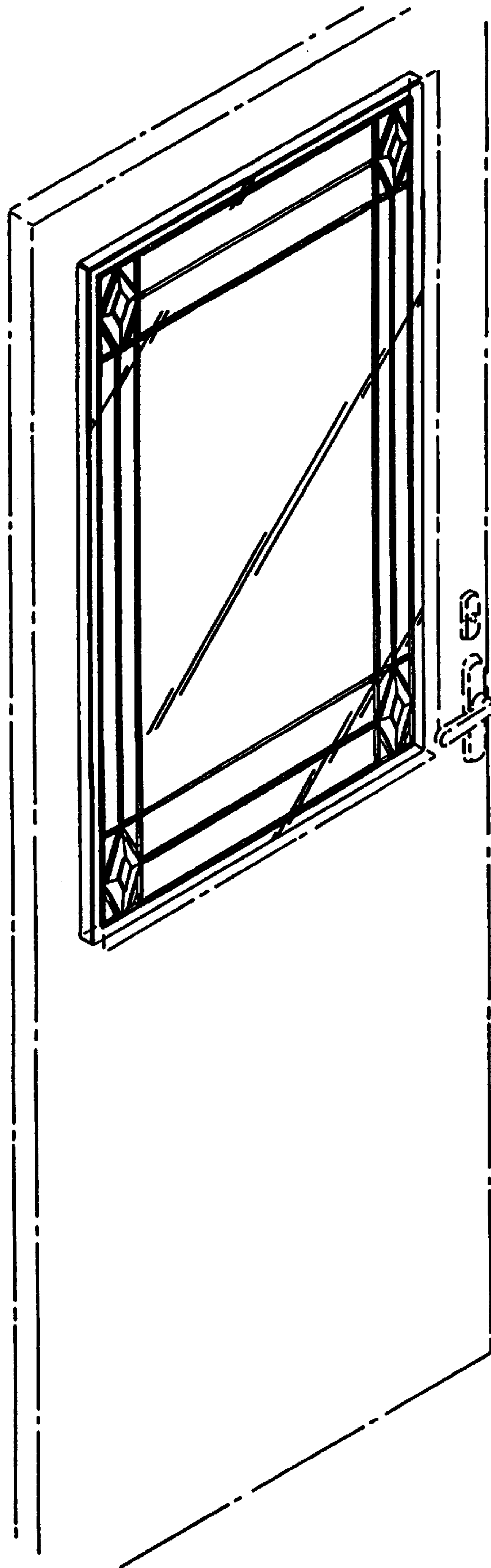

FIG. 15



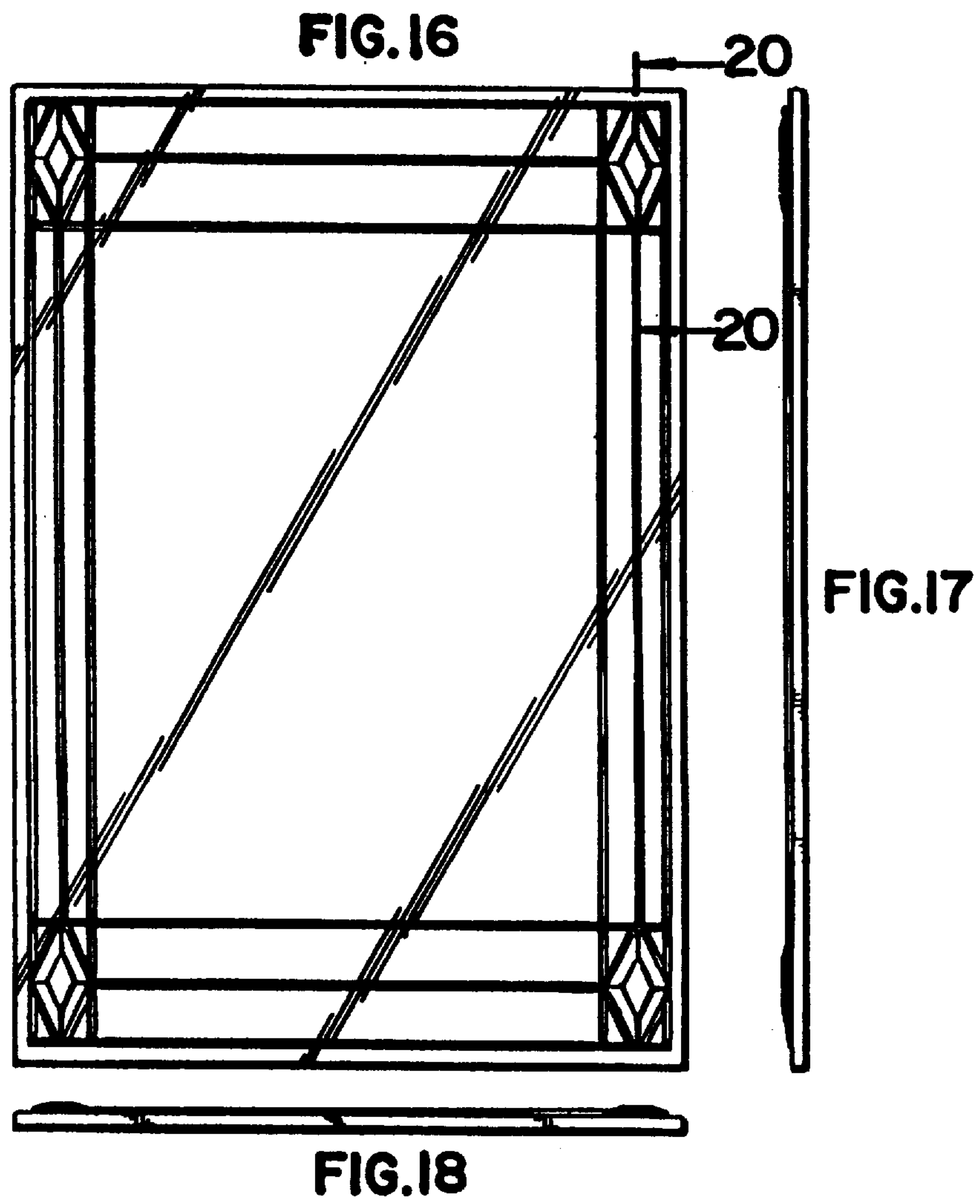

FIG. 19

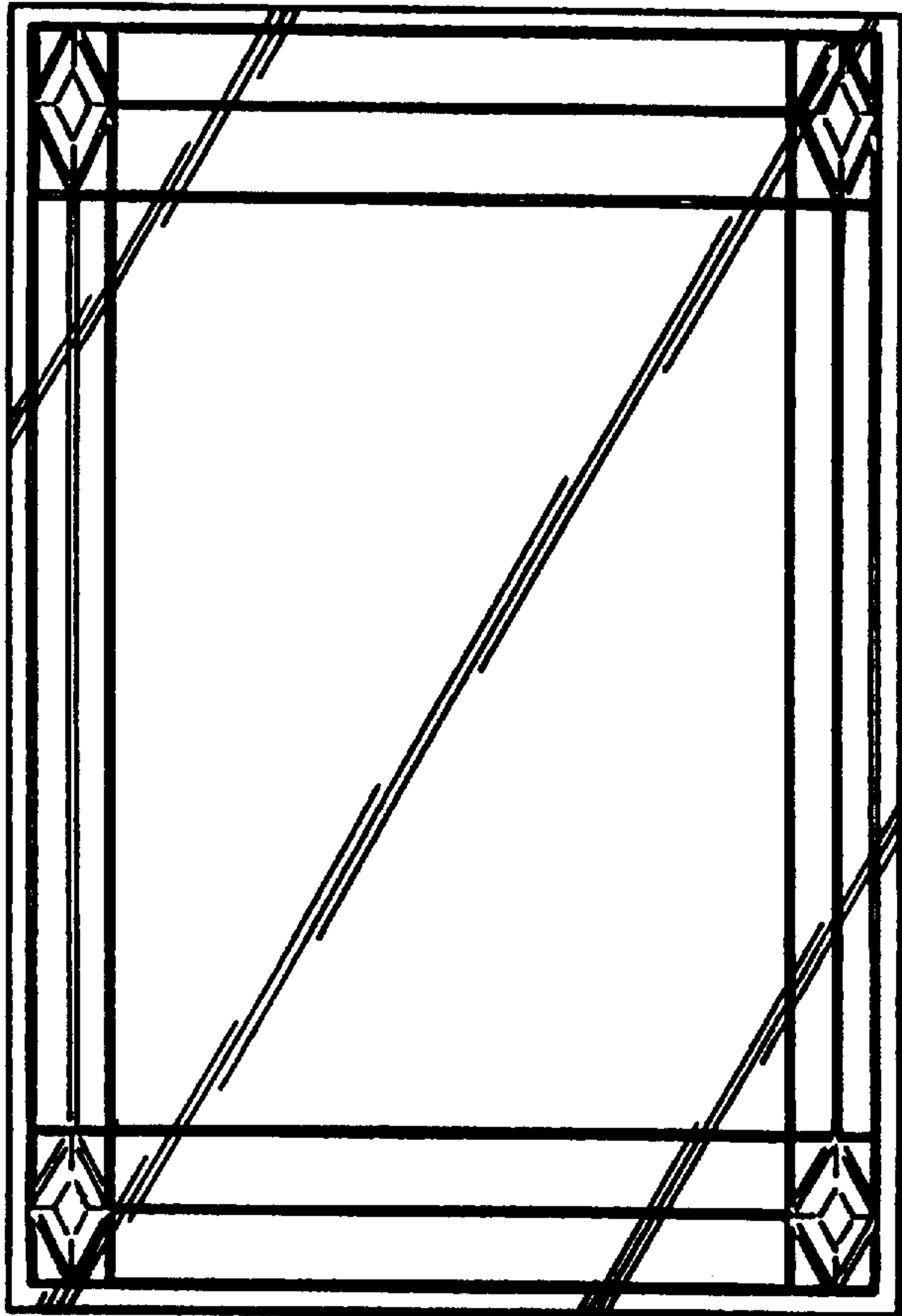

FIG. 20

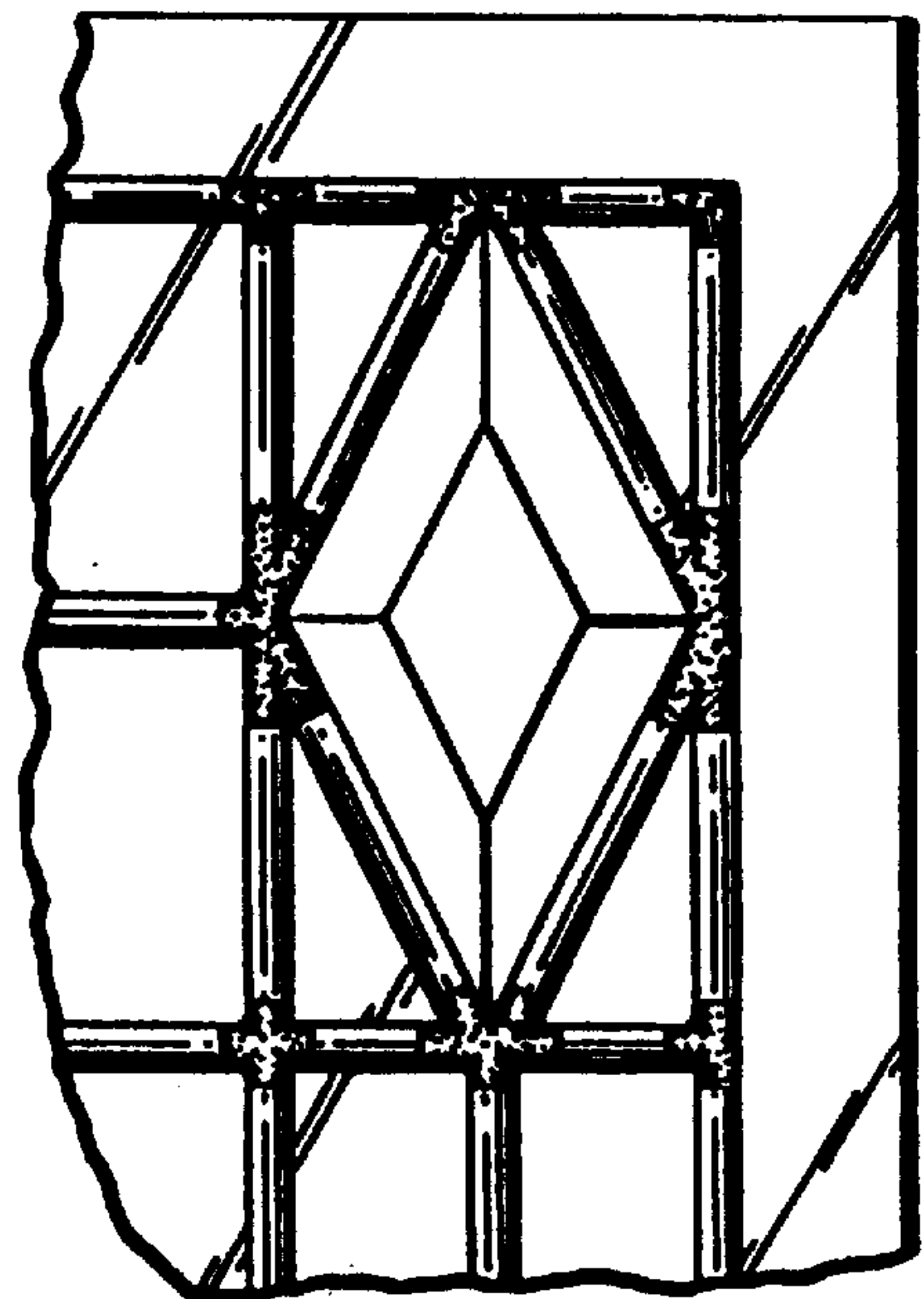
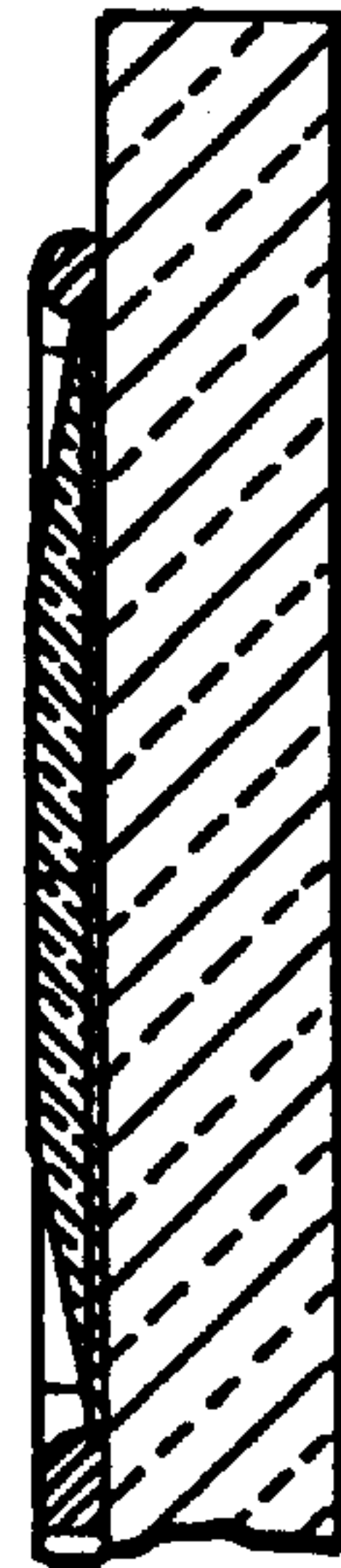

FIG. 21