



US00D402338S

United States Patent [19]
Davis

[11] **Patent Number: Des. 402,338**
[45] **Date of Patent: **Dec. 8, 1998**

[54] **BASKETBALL BACKBOARD**

[75] Inventor: **Mark Davis**, Wauwatosa, Wis.

[73] Assignee: **Huffy Corporation**, Miamisburg, Ohio

[**] Term: **14 Years**

[21] Appl. No.: **77,458**

[22] Filed: **Oct. 6, 1997**

[51] **LOC (6) Cl.** **21-02**

[52] **U.S. Cl.** **D21/701**

[58] **Field of Search** D21/200, 201;
473/481-484, 472

[56] **References Cited**

U.S. PATENT DOCUMENTS

D. 357,518	4/1995	Hansberry	D21/201
5,207,407	5/1993	Fitzsimmons et al.	473/472
5,433,432	7/1995	Adler	473/472
5,570,879	11/1996	Glancey et al.	473/481 X

Primary Examiner—Ted Shooman
Assistant Examiner—Richelle Shelton
Attorney, Agent, or Firm—Michael J. Bell; Howrey & Simon

[57] **CLAIM**

The ornamental design for a basketball backboard, as shown and described.

DESCRIPTION

FIG. 1 is a perspective view of a basketball backboard embodying my new design;
FIG. 2 is a front elevational view thereof;
FIG. 3 is a top plan view thereof;
FIG. 4 is a left side elevational view thereof, the right side elevational view being a mirror image thereof;
FIG. 5 is a bottom plan view thereof;
FIG. 6 is a rear elevational view thereof;
FIG. 7 is a front elevational view of a second embodiment of my invention, the top plan, bottom plan, left and right side elevational views being identical to the first embodiment; and,
FIG. 8 is a rear elevational view thereof.
The front panel of the embodiment disclosed in FIGS. 1-6, may be transparent or translucent.
The dashed lines in FIG. 1 are to illustrate environment only and form no part of the claimed design.

1 Claim, 5 Drawing Sheets

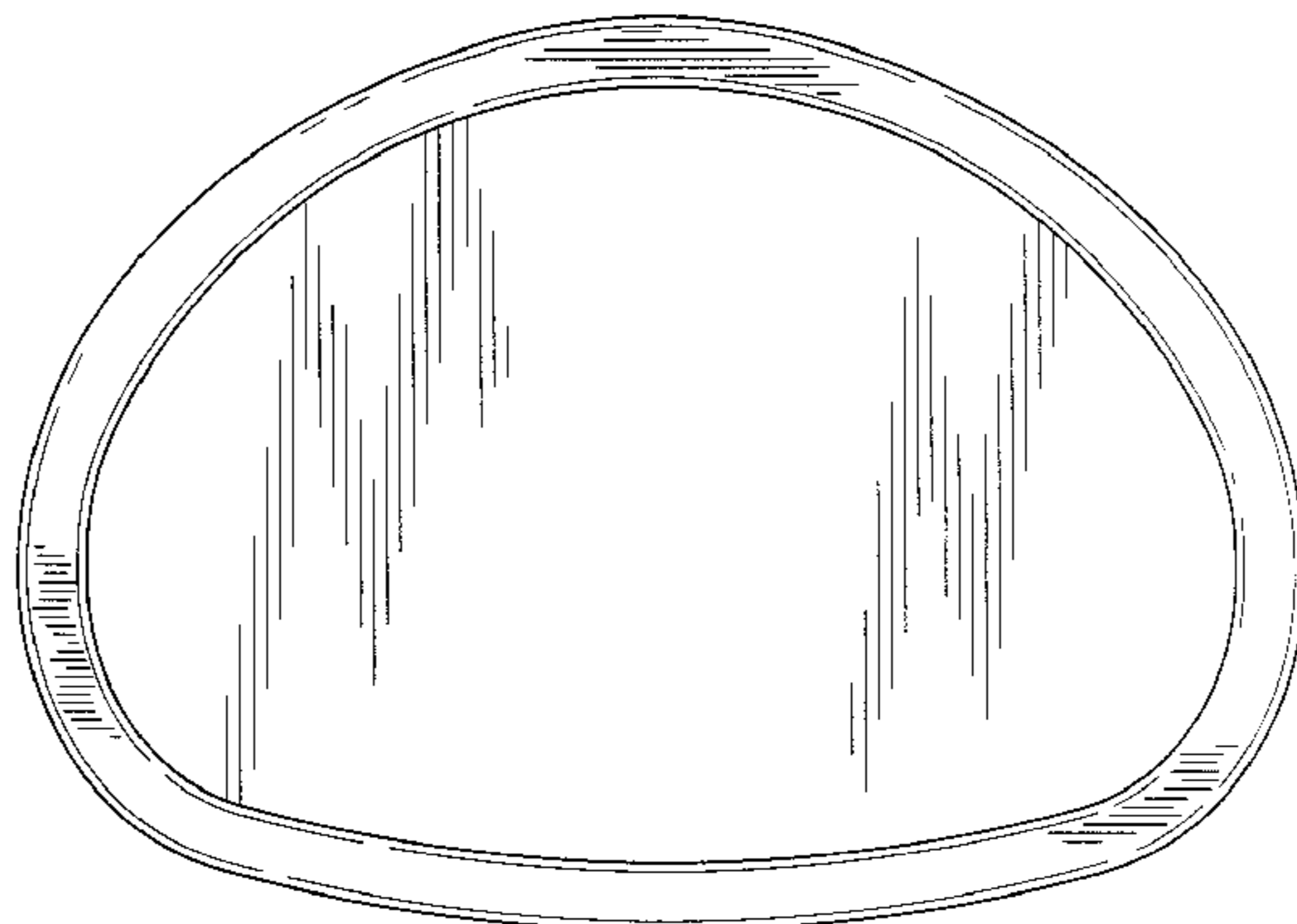
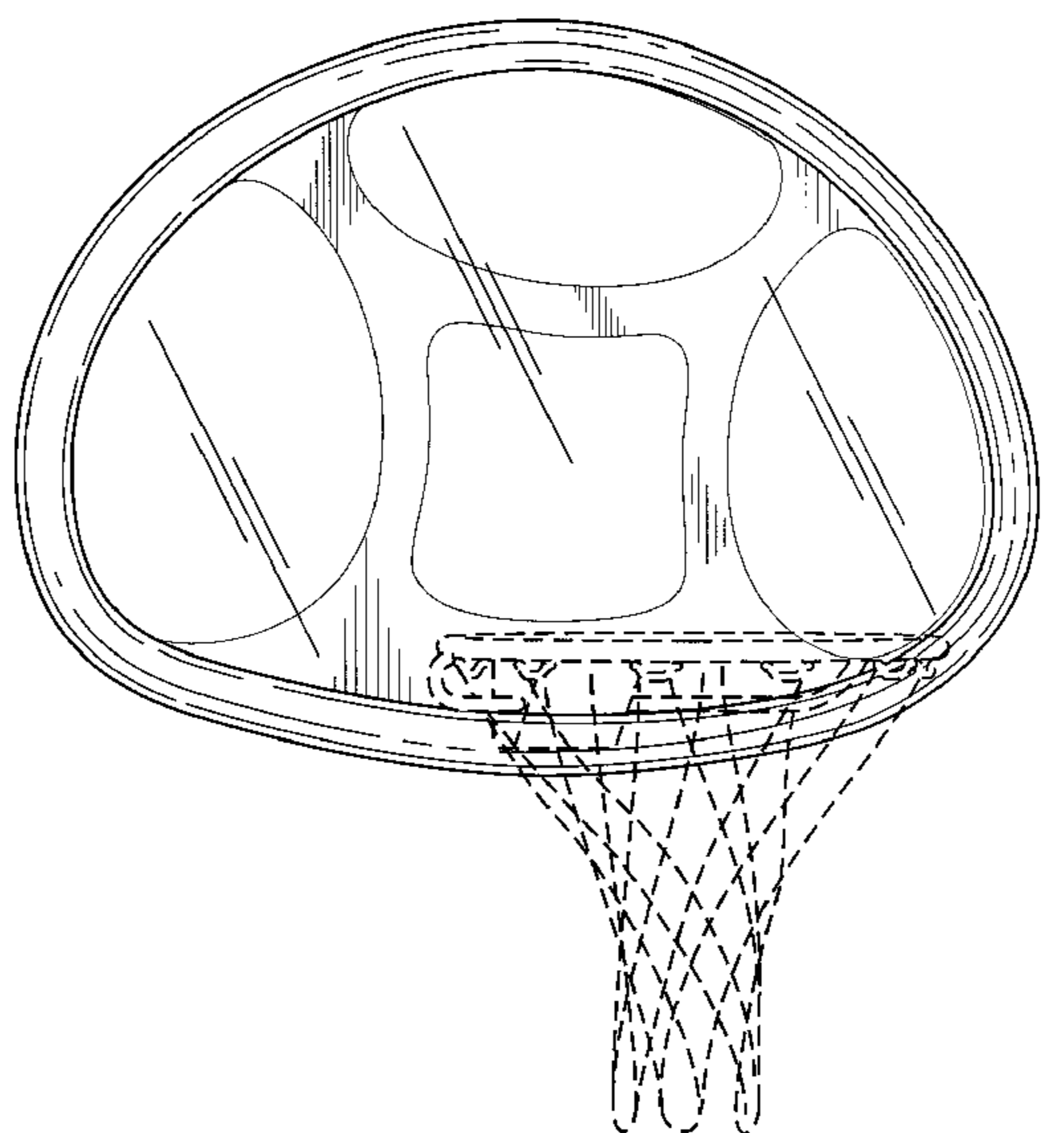

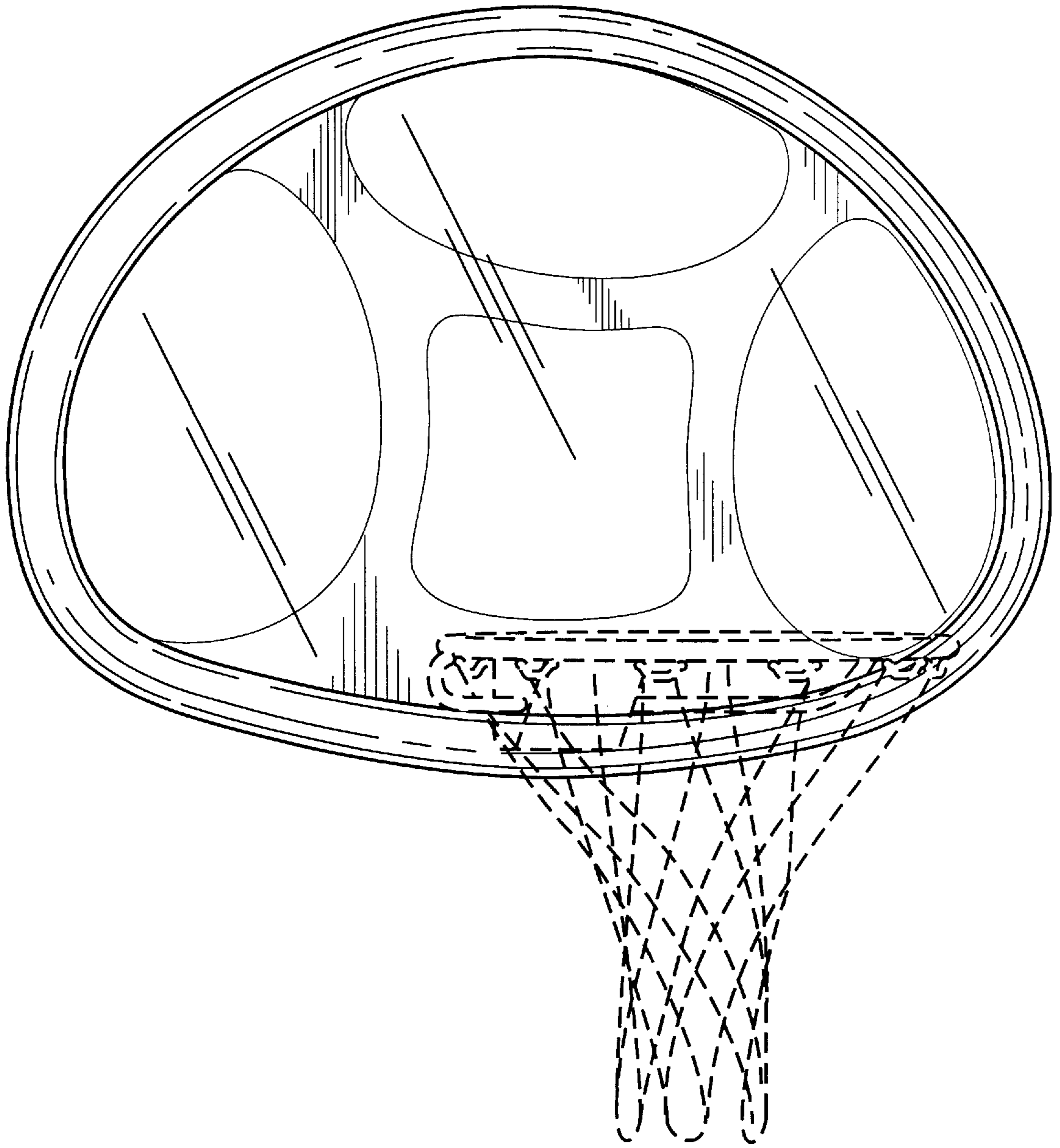

FIG. 1

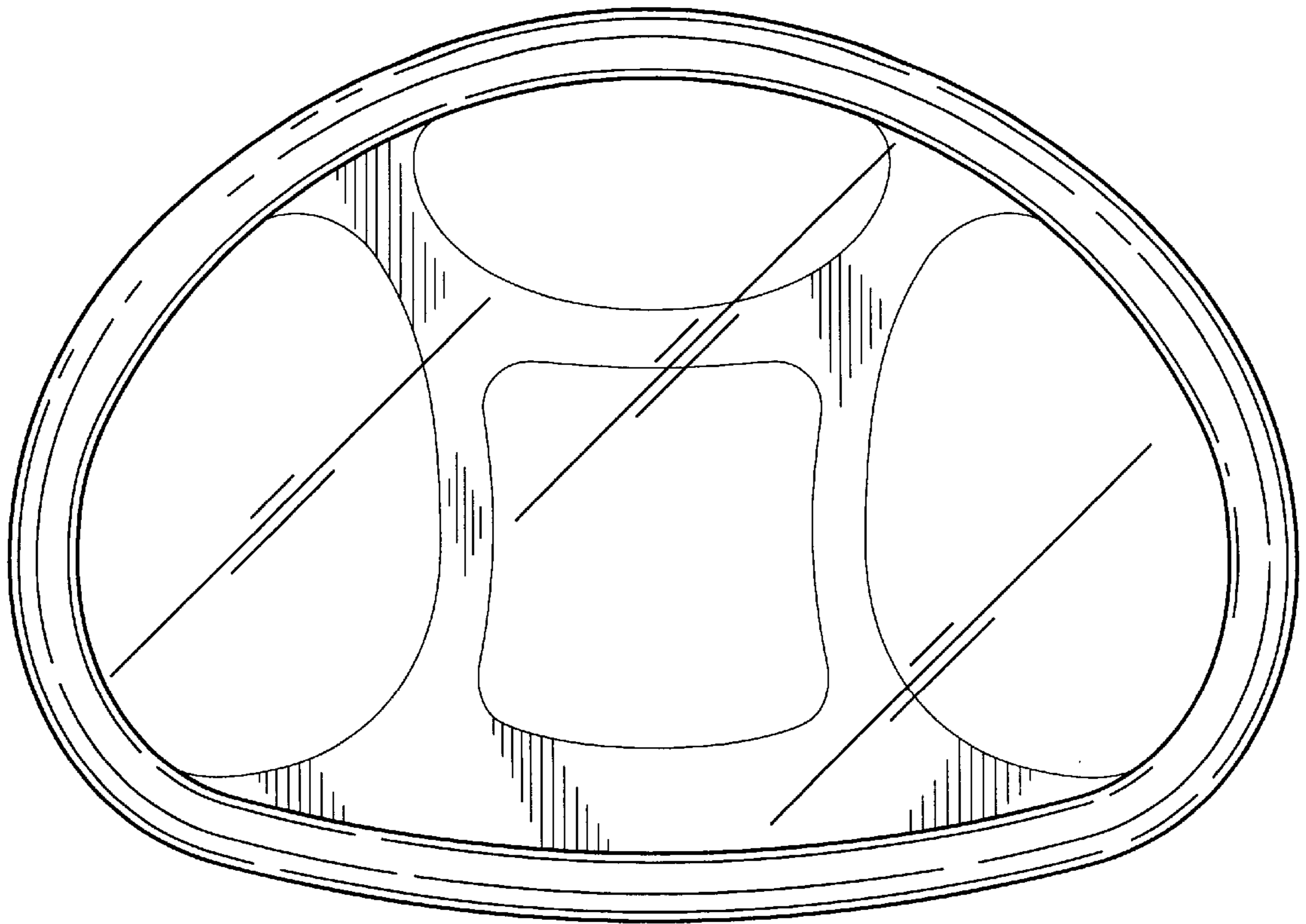

FIG. 2



FIG. 3



FIG. 4

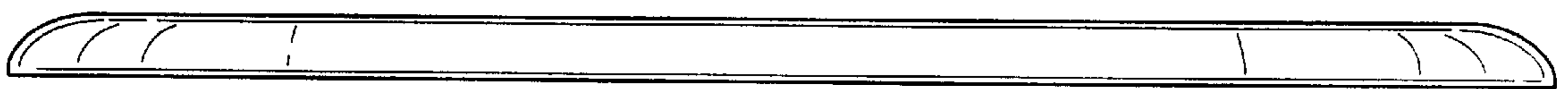

FIG. 5

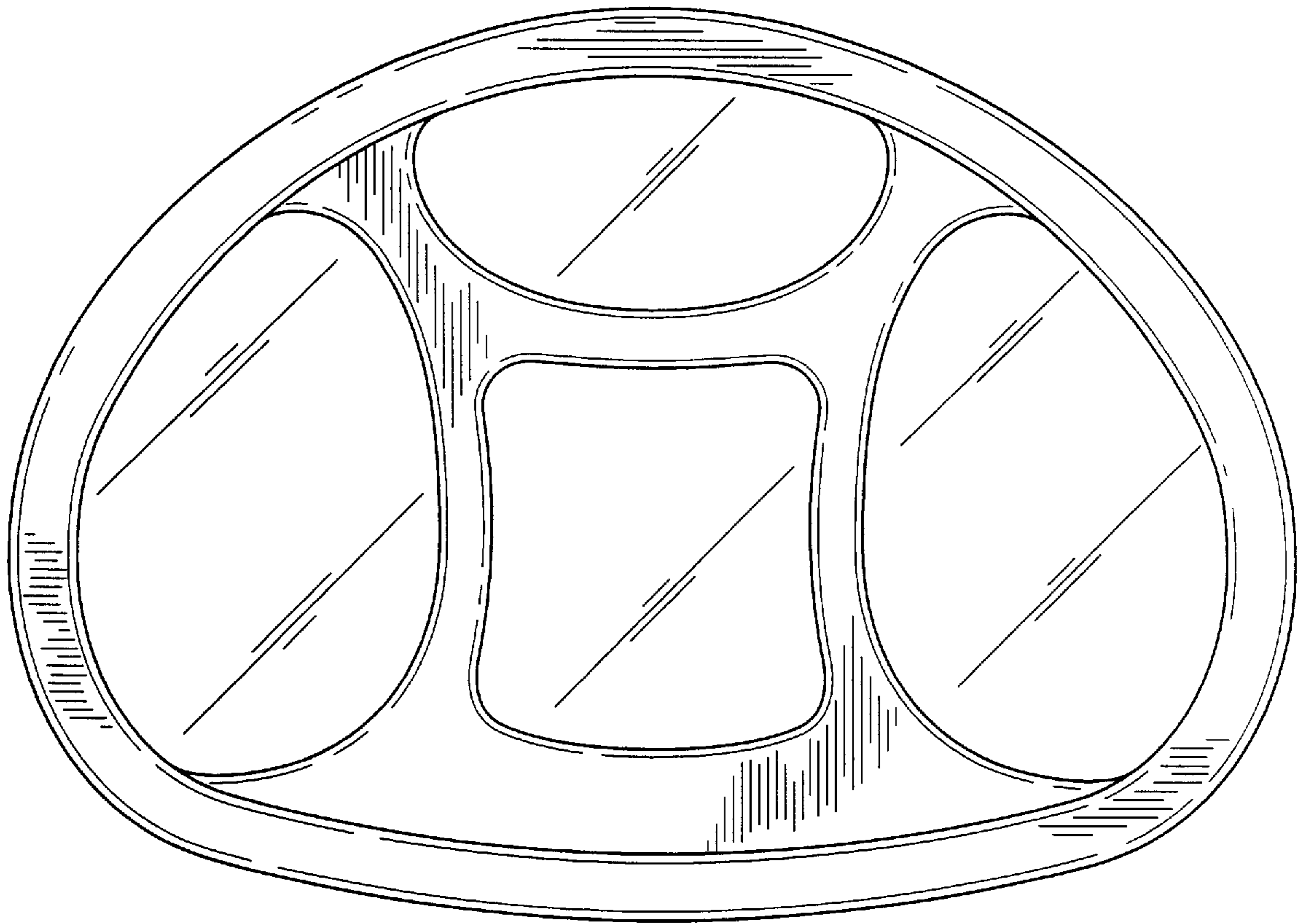

FIG. 6

FIG. 7

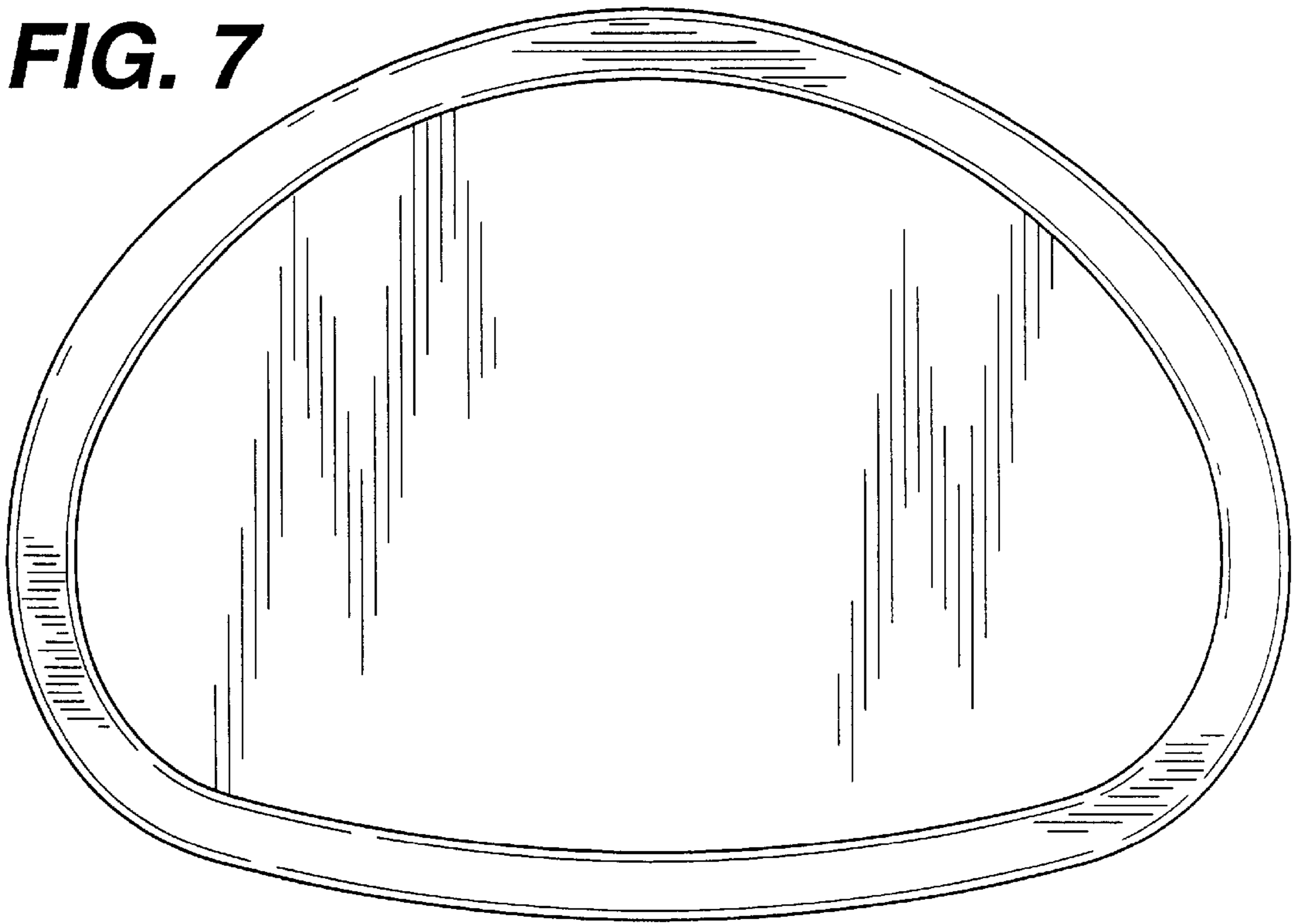

FIG. 8

