



US00D402325S

United States Patent [19]

[11] **Patent Number:** **Des. 402,325**

Drossos

[45] **Date of Patent:** ****Dec. 8, 1998**

[54] **PUTTER HEAD HAVING ELLIPTICAL CAVITY**

Primary Examiner—Sandra L. Morris
Assistant Examiner—Mitchell I. Siegel
Attorney, Agent, or Firm—Antony C. Edwards

[76] Inventor: **William Drossos**, 1206 Duncan Ave.,
Penticton, British Columbia, Canada,
V2A 2X2

[57] **CLAIM**

[**] Term: **14 Years**

The ornamental design for a putter head having elliptical cavity, as shown and described.

[21] Appl. No.: **78,866**

DESCRIPTION

[22] Filed: **Nov. 4, 1997**

FIG. 1 is, in front perspective view, the design of the present invention;

[51] **LOC (6) Cl.** **21-02**

FIG. 2 is, in front elevation view, the design of FIG. 1;

[52] **U.S. Cl.** **D21/219**

FIG. 3 is, in rear elevation view, the design of FIG. 1;

[58] **Field of Search** D21/217-219;
473/324, 340, 341

FIG. 4 is, in top plan view, the design of FIG. 1;

FIG. 5 is, in bottom view, the design of FIG. 1;

FIG. 6 is, in right side elevation view, the design of FIG. 1;

FIG. 7 is, in left side elevation view, the design of FIG. 1;

FIG. 8 is, in rear perspective view, the design of FIG. 1; and,

FIG. 9 is a cross-sectional view along line 9—9 in FIG. 2.

[56] **References Cited**

U.S. PATENT DOCUMENTS

D. 321,232	10/1991	Antonious	D21/217
D. 328,114	7/1992	Antonious	D21/217
D. 381,725	7/1997	Sugo	D21/217

1 Claim, 9 Drawing Sheets

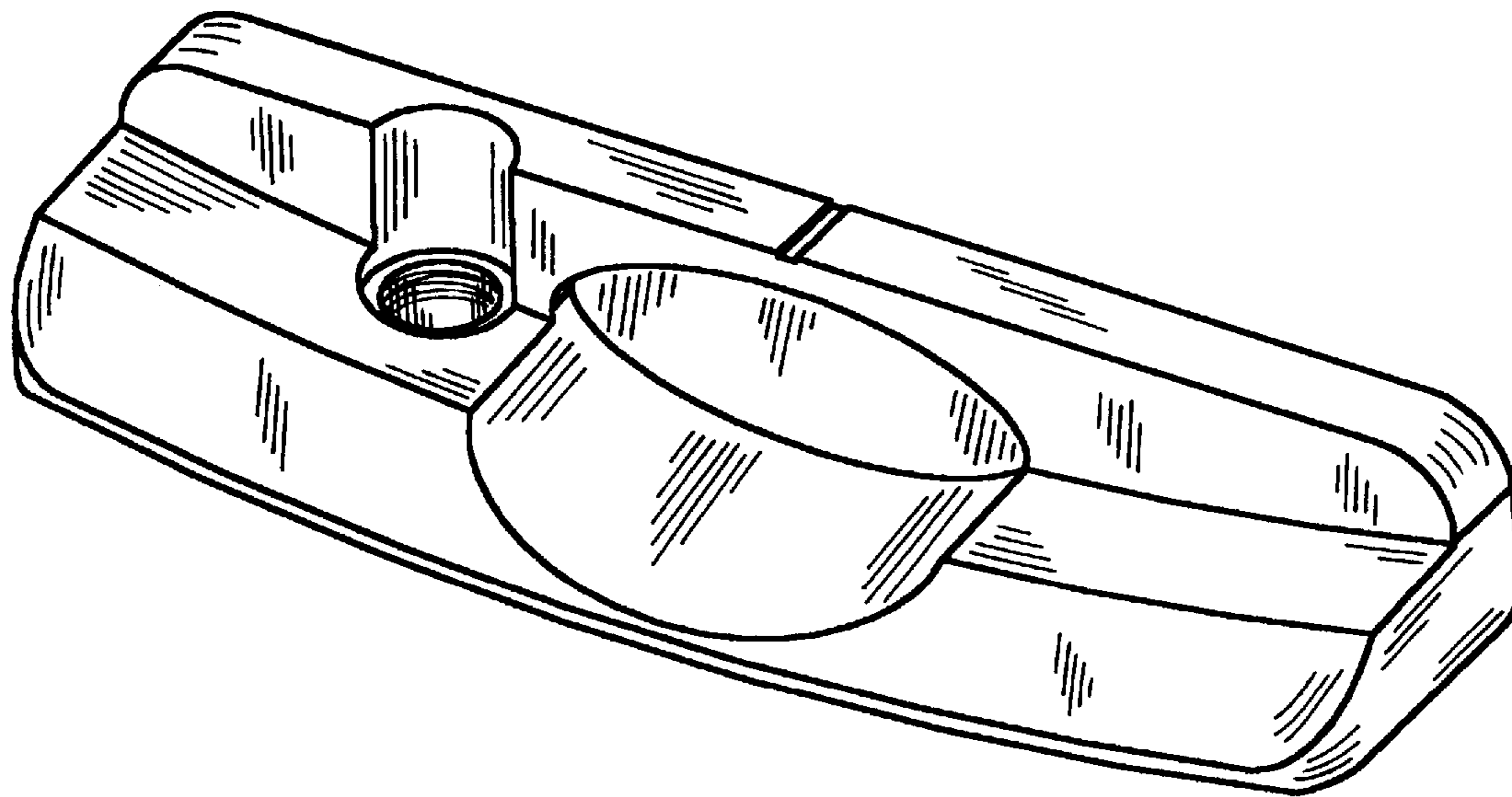

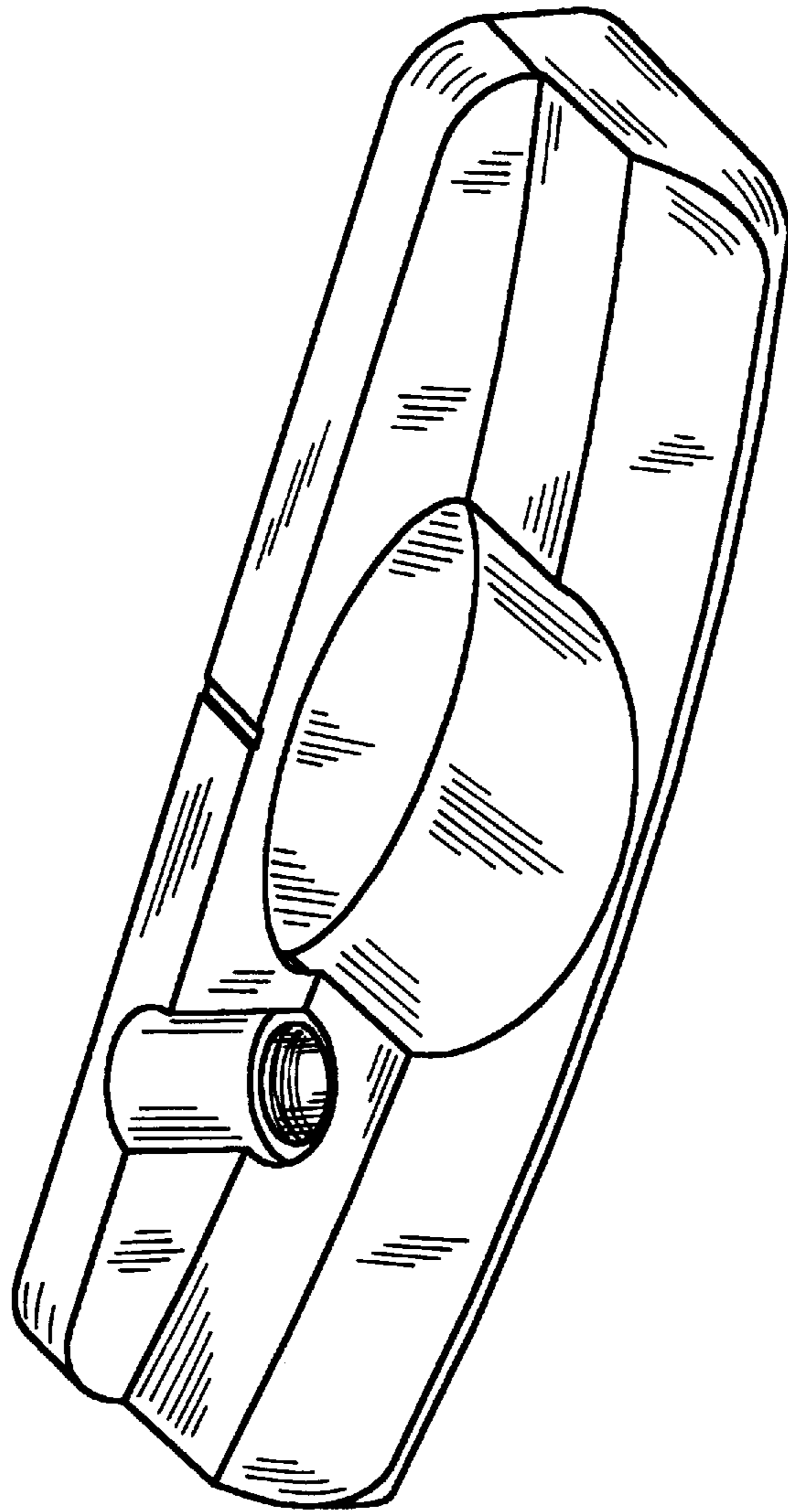

FIG. 1

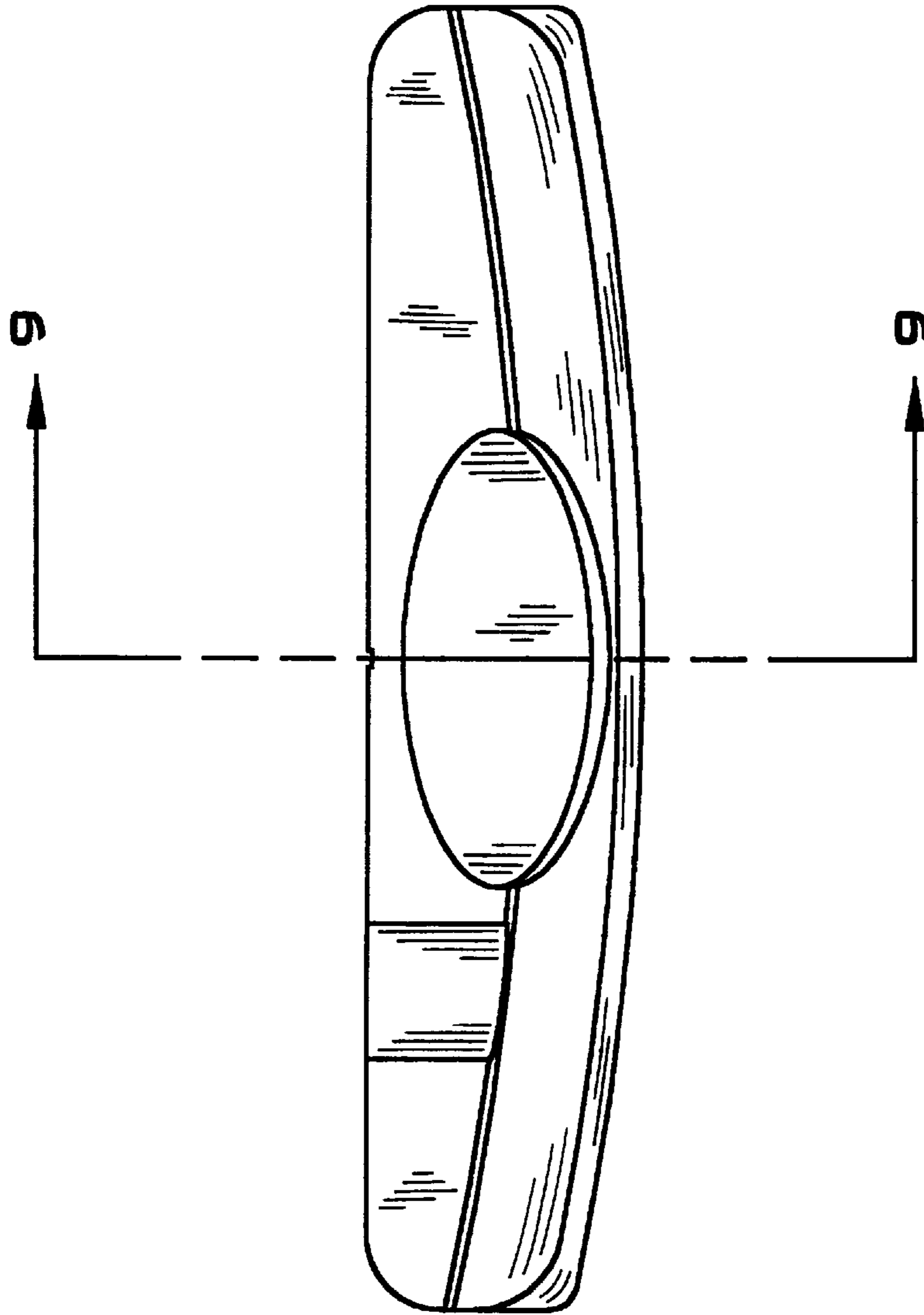

FIG. 2

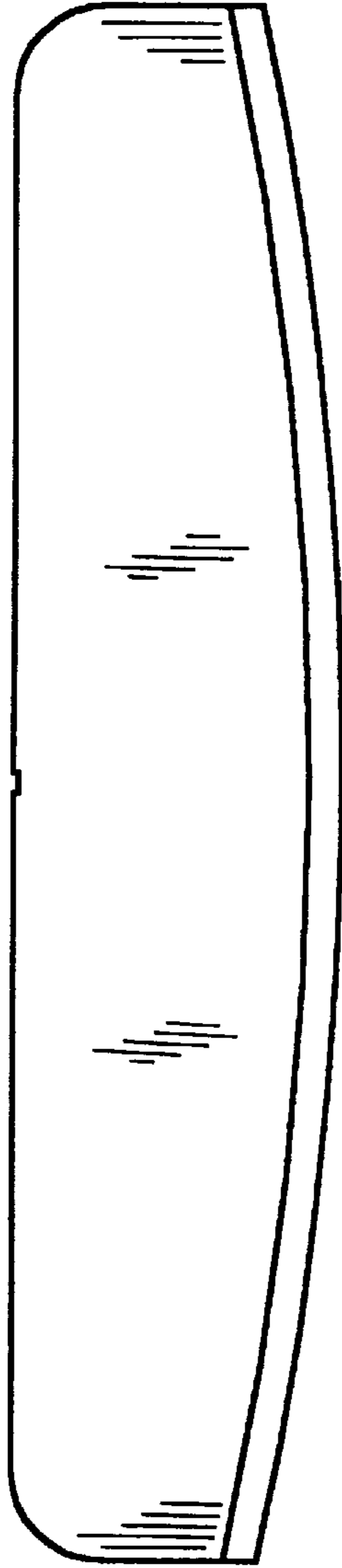

FIG. 3

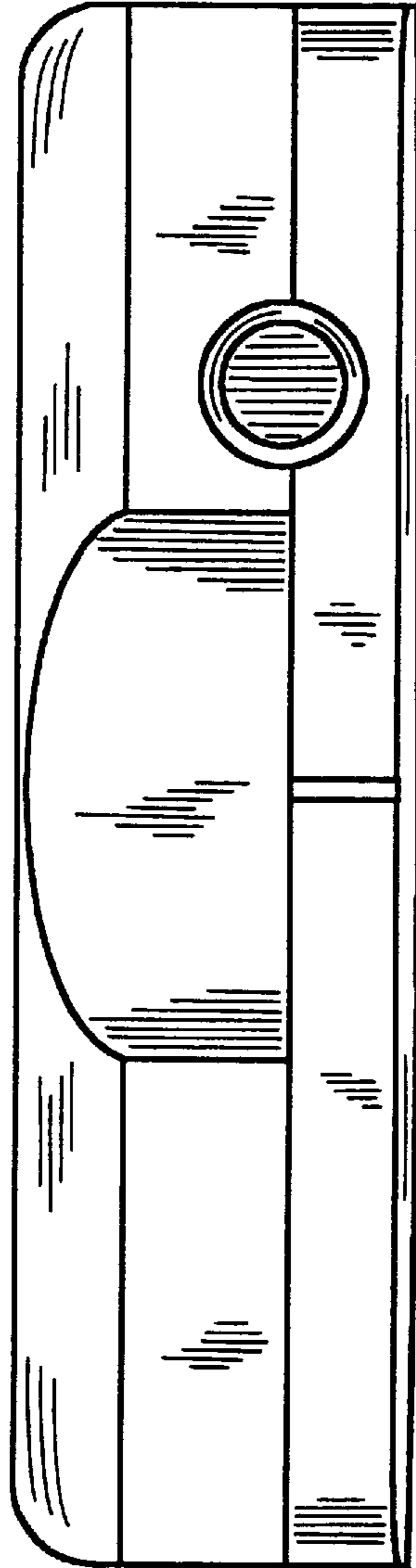

FIG. 4

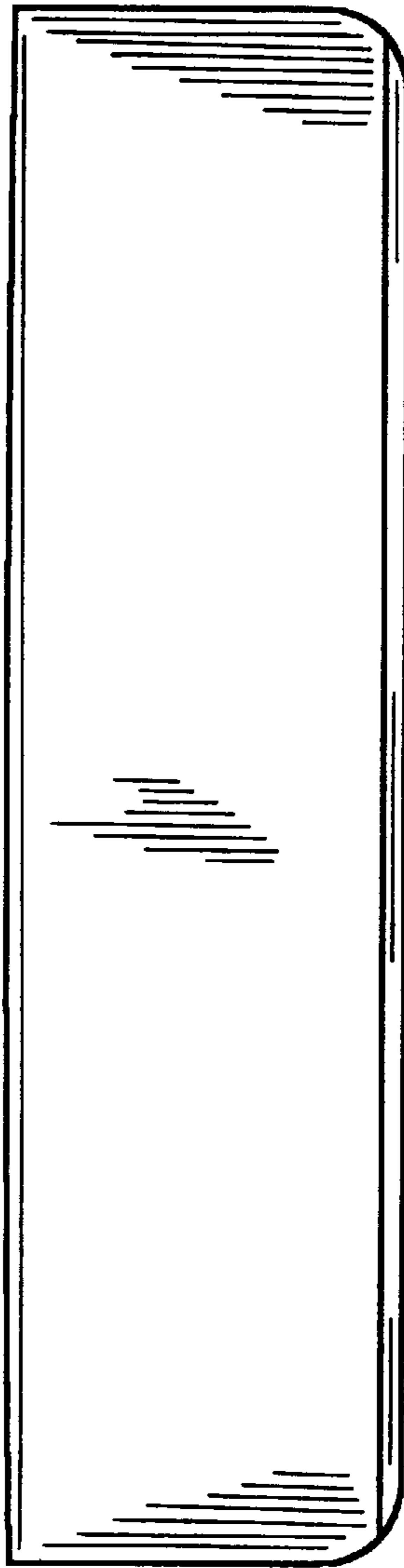

FIG. 5

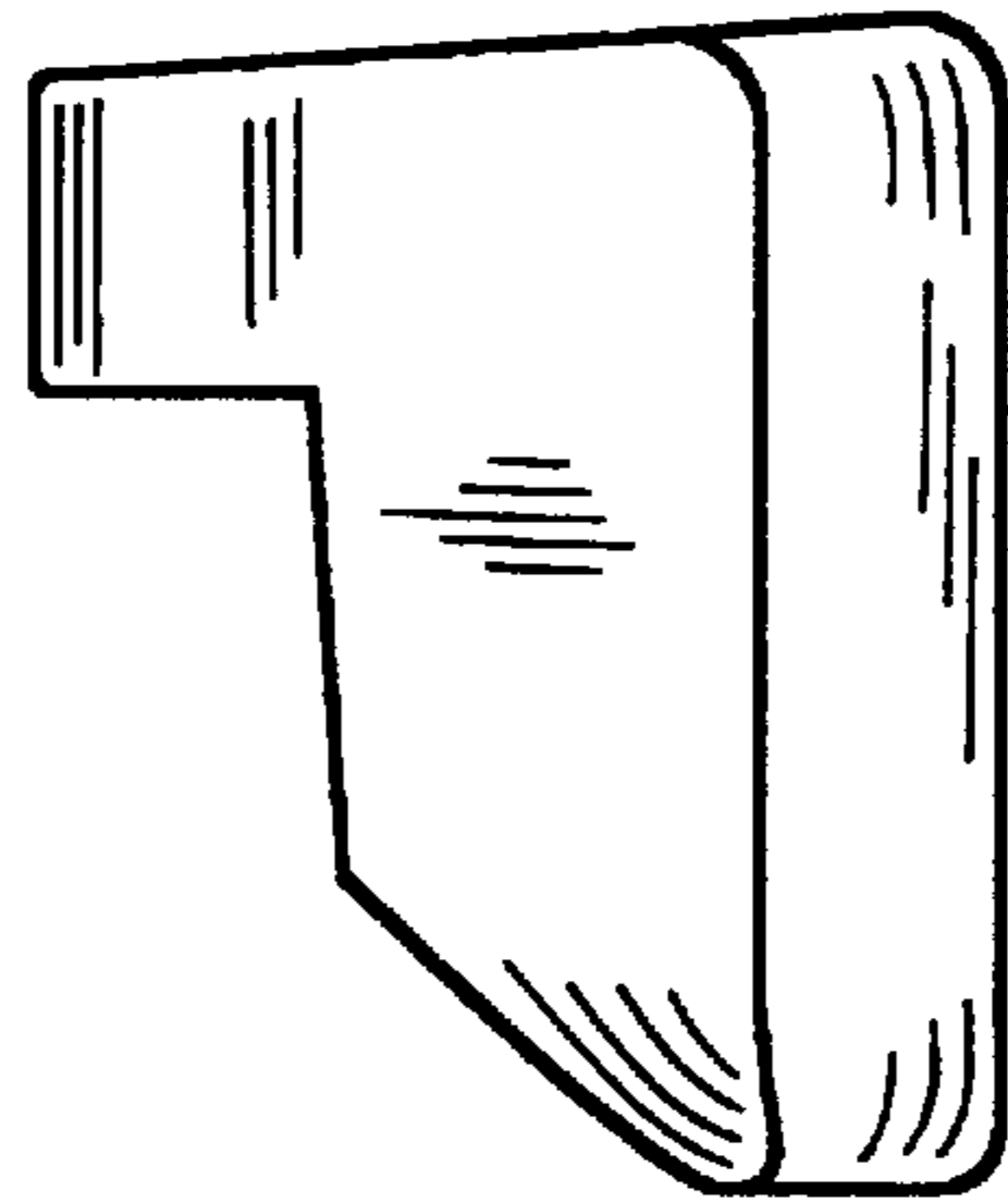

FIG. 6

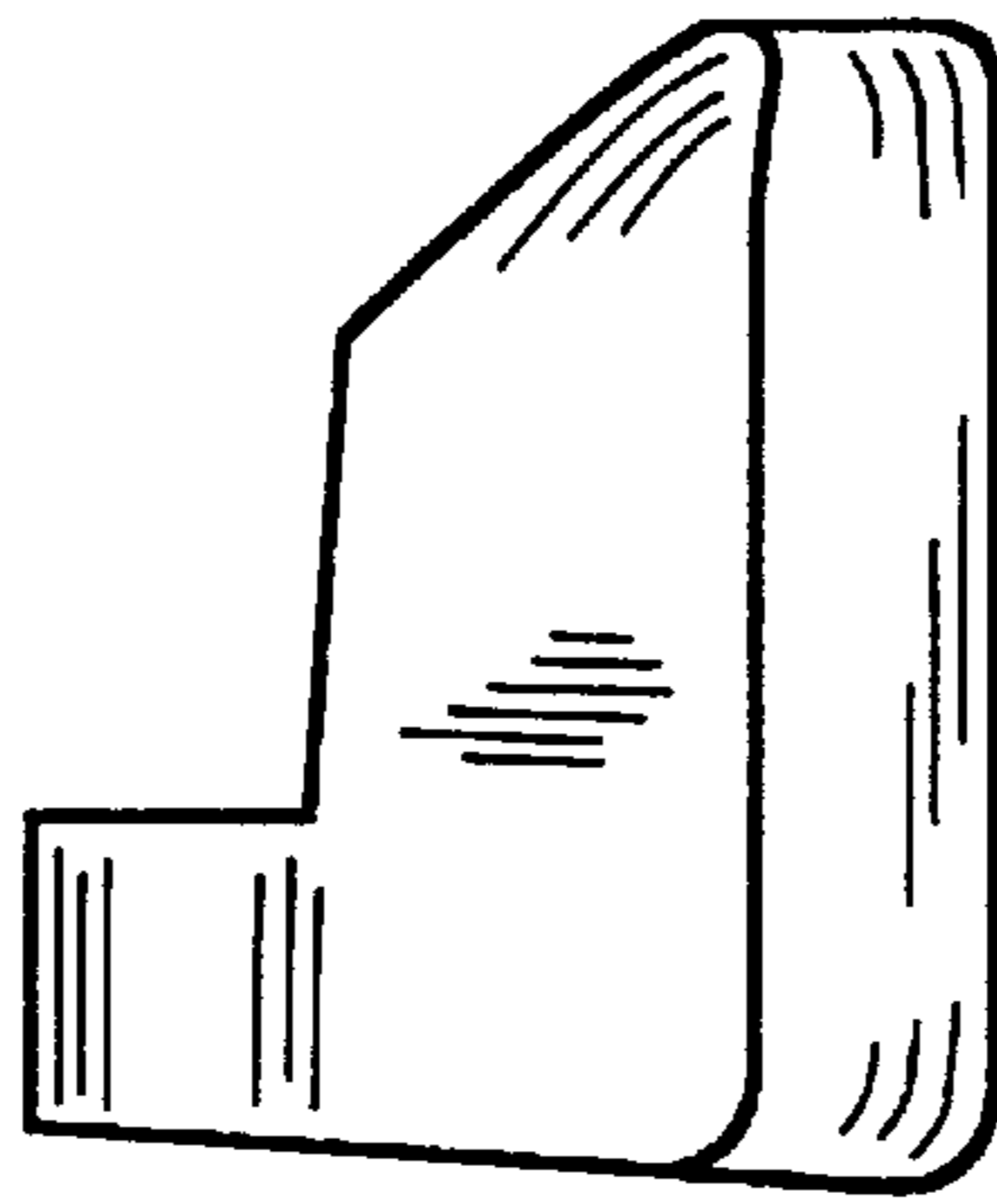

FIG. 7

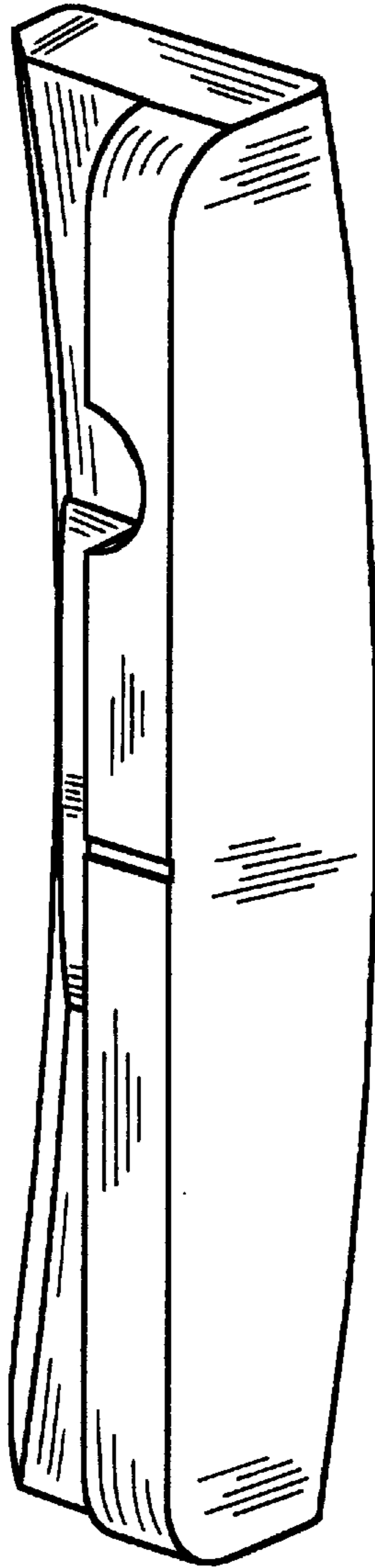

FIG. 8

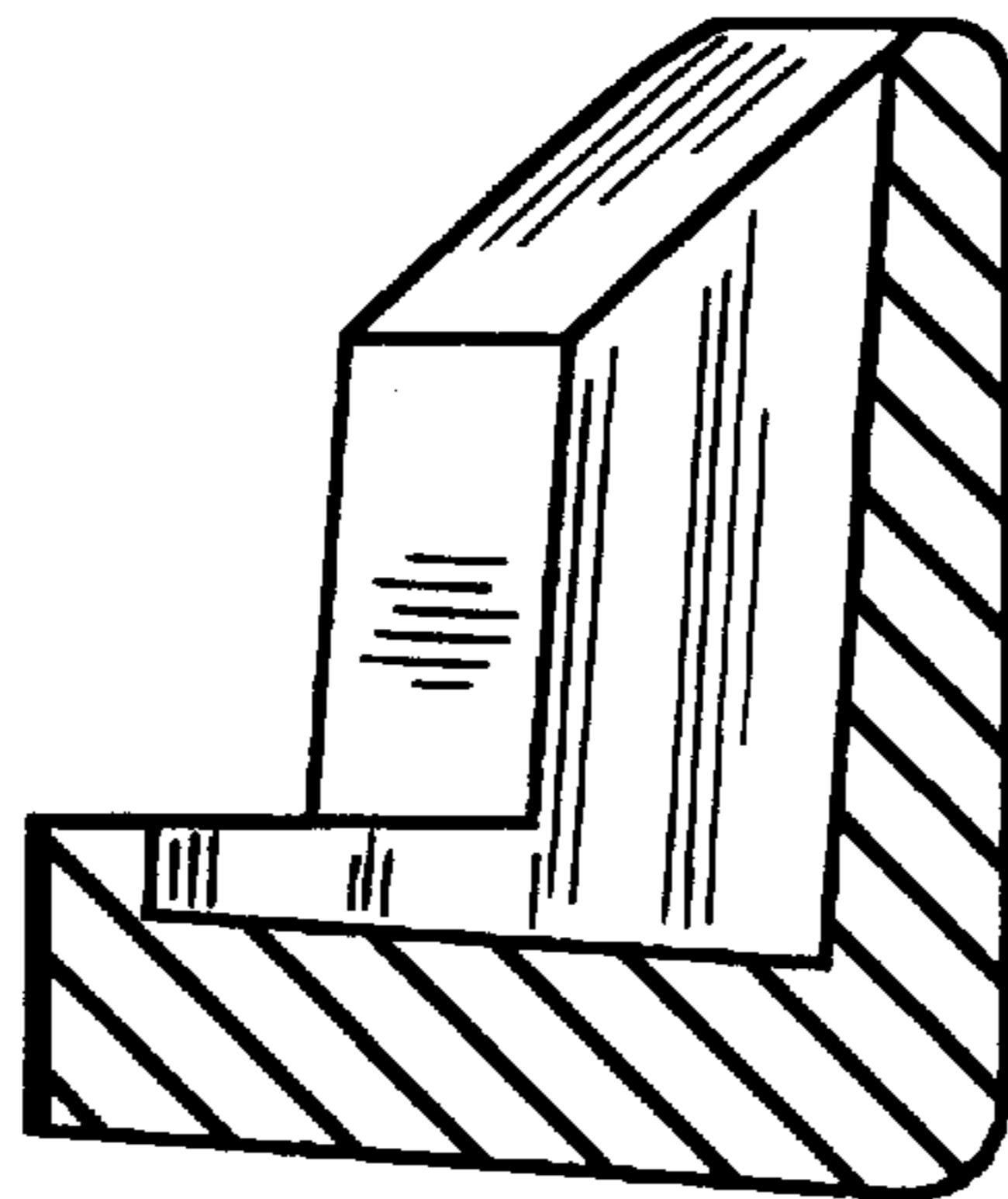

FIG. 9