



US00D402166S

# United States Patent [19]

Wallays

[11] **Patent Number:** **Des. 402,166**

[45] **Date of Patent:** **\*\*Dec. 8, 1998**

[54] **PASTRY BAG**

[75] Inventor: **Nele Wallays**, Antwerp, Belgium

[73] Assignee: **Dart Industries Inc.**, Orlando, Fla.

[\*\*] Term: **14 Years**

[21] Appl. No.: **75,783**

[22] Filed: **Aug. 22, 1997**

[51] **LOC (6) Cl.** ..... **07-04**

[52] **U.S. Cl.** ..... **D7/669; D7/700**

[58] **Field of Search** ..... D7/669, 700; 141/331, 141/333, 334, 339, 106; 222/92, 107, 575; 425/190, 191, 461

[56] **References Cited**

**U.S. PATENT DOCUMENTS**

- D. 299,302 1/1989 Gray ..... D7/700
- 1,294,011 2/1919 Williams .
- 2,320,496 6/1943 Wechsler .

- 3,847,523 11/1974 Parrish et al. .
- 4,205,765 6/1980 May .
- 4,813,862 3/1989 Bowers et al. .

*Primary Examiner*—Terry A. Wallace  
*Attorney, Agent, or Firm*—John A. Doninger

[57] **CLAIM**

The ornamental design for a pastry bag, as shown and described.

**DESCRIPTION**

FIG. 1 is a top perspective view of a pastry bag showing my new design;  
 FIG. 2 is a top plan view thereof;  
 FIG. 3 is a bottom plan view thereof;  
 FIG. 4 is a front elevation view thereof;  
 FIG. 5 is a rear elevation view thereof;  
 FIG. 6 is a right side view thereof;  
 FIG. 7 is a left side view thereof; and,  
 FIG. 8 is a perspective view thereof partially unfolded.

**1 Claim, 2 Drawing Sheets**

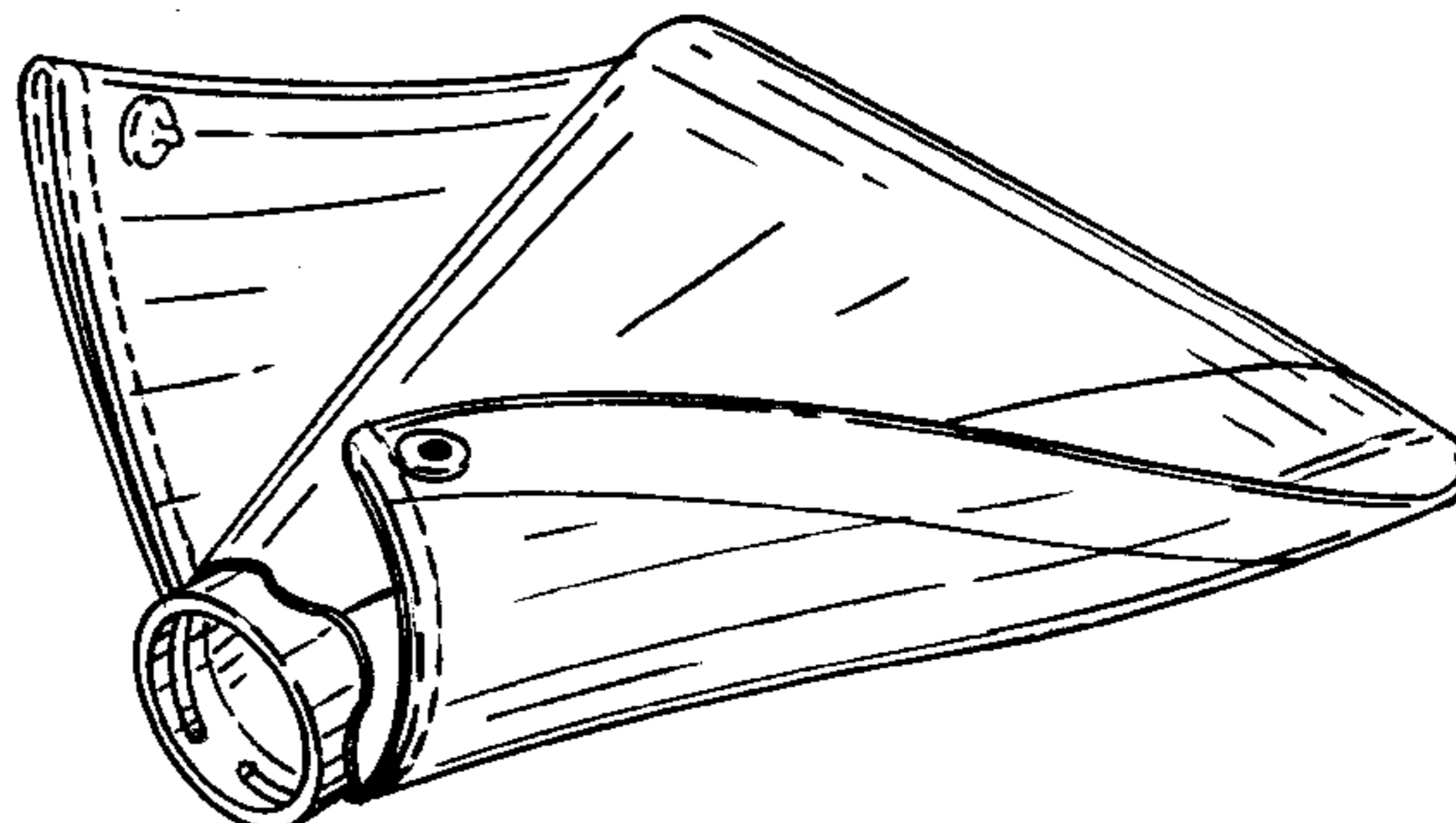
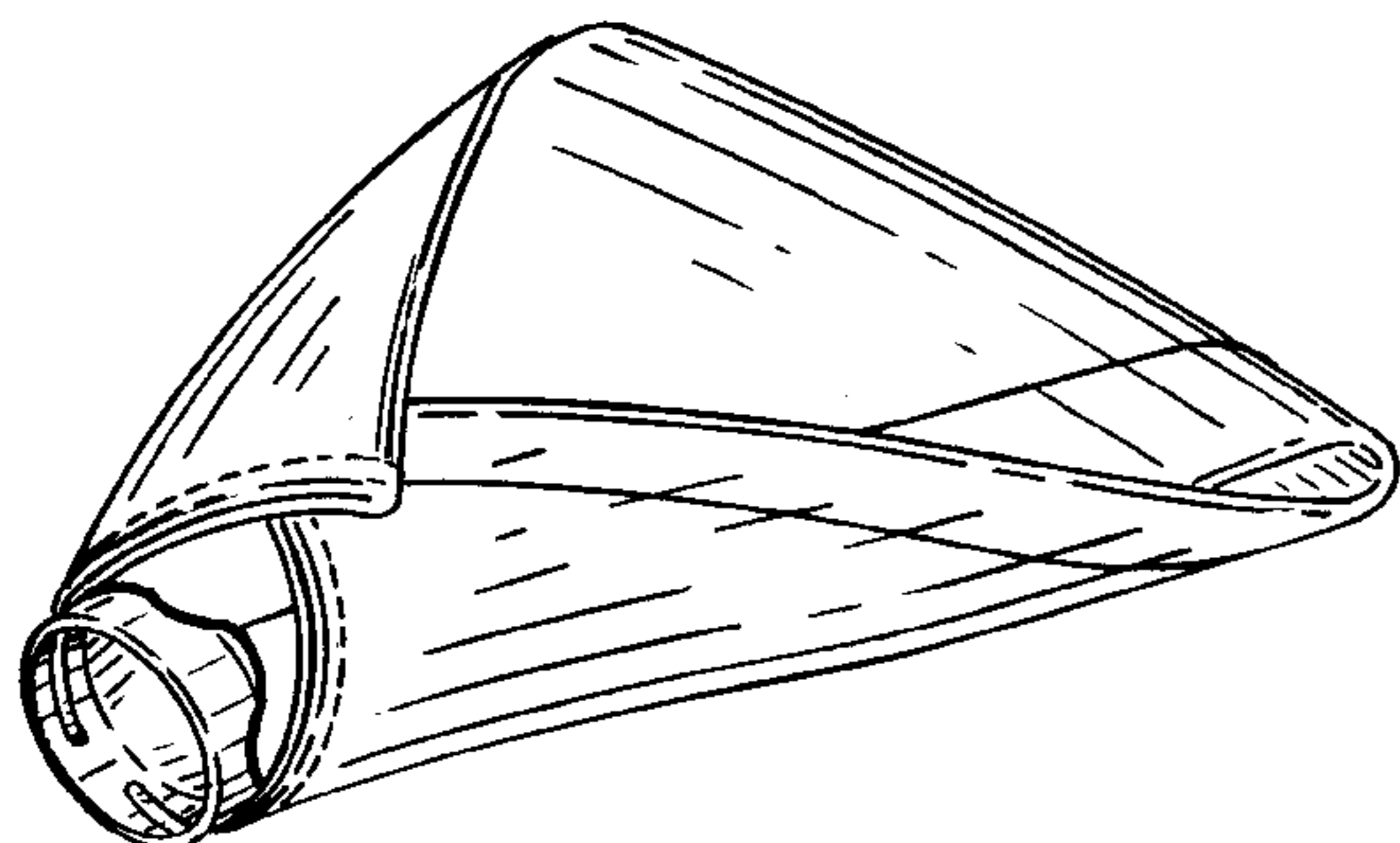

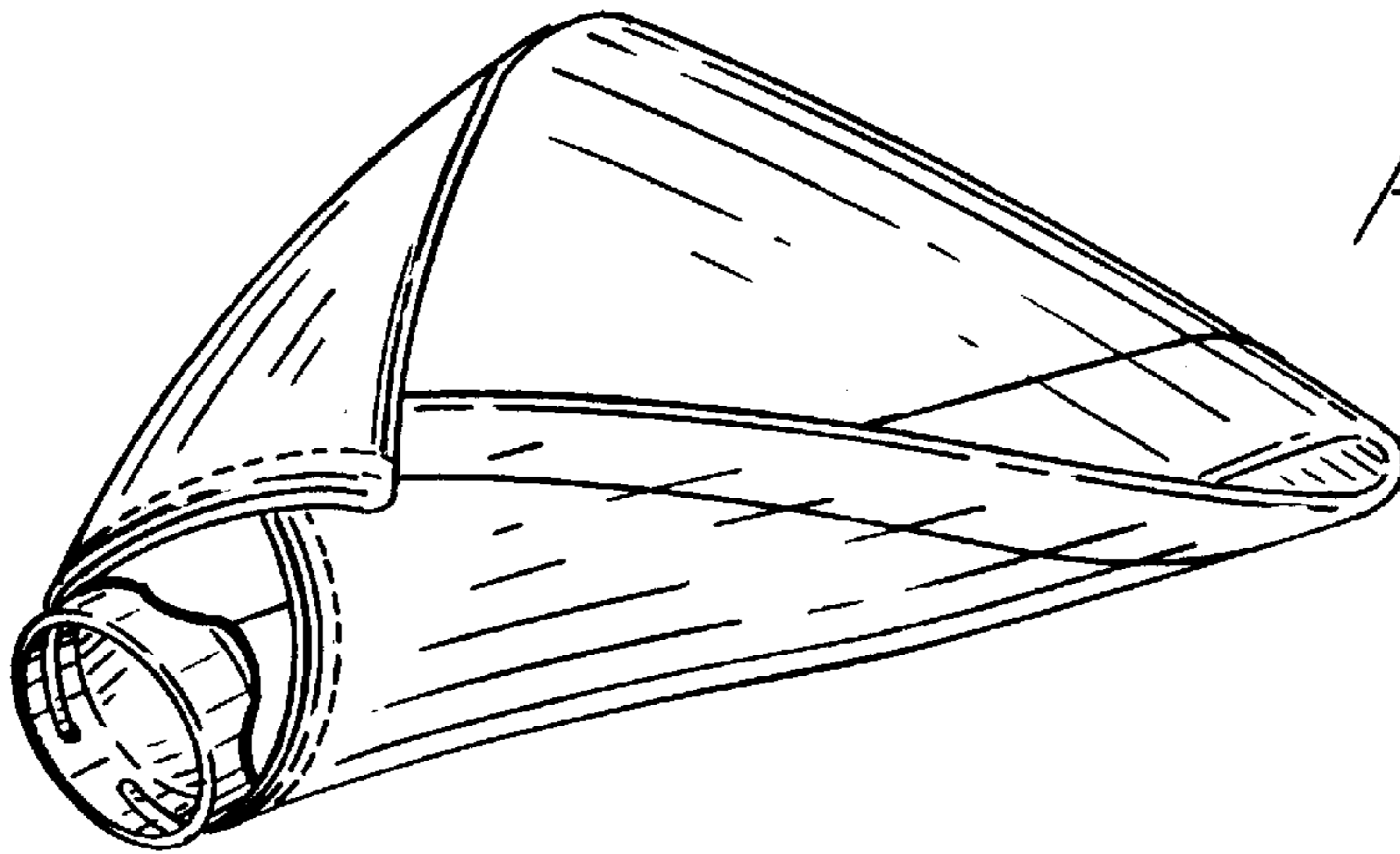

FIG. 1

FIG. 2

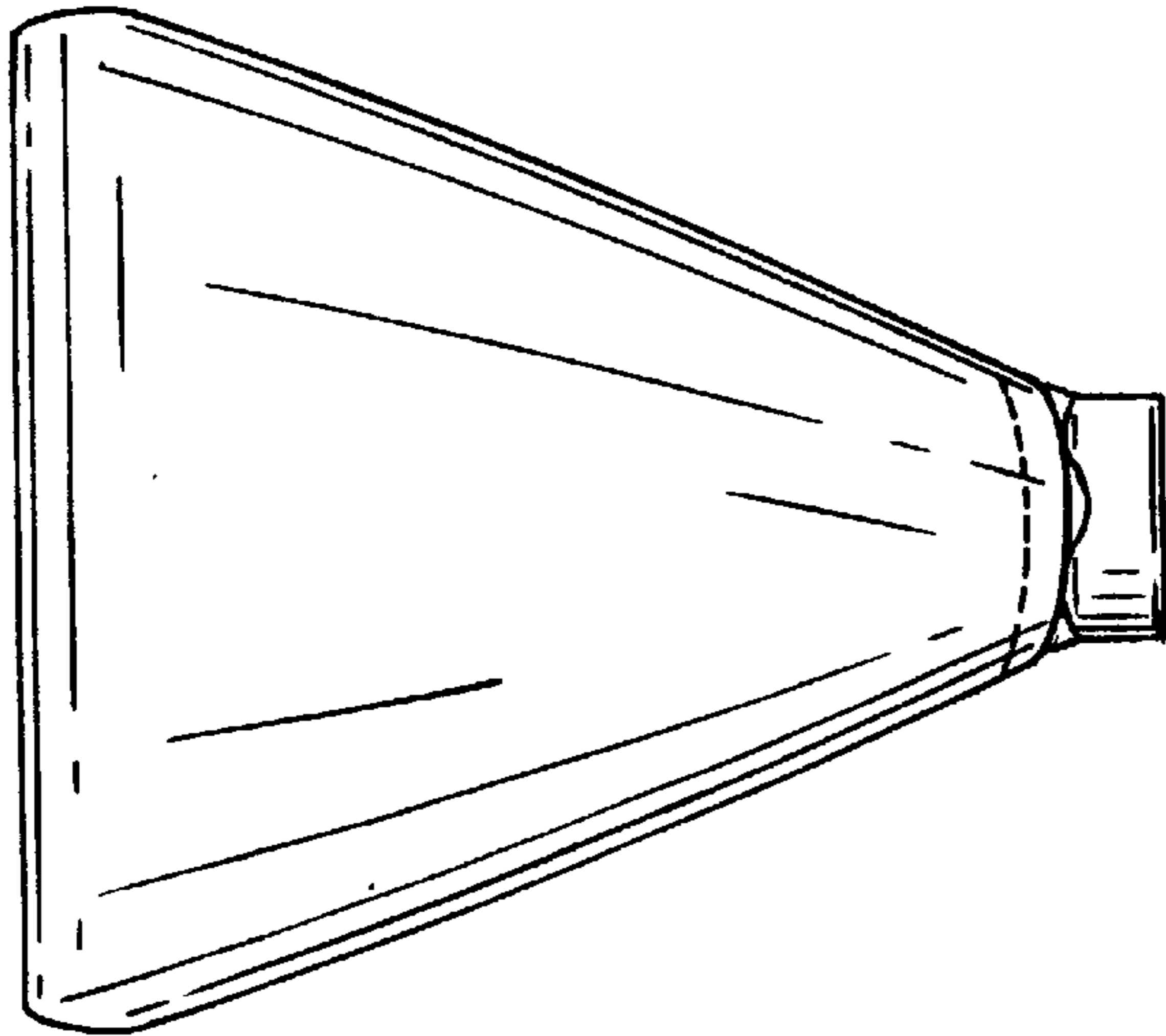
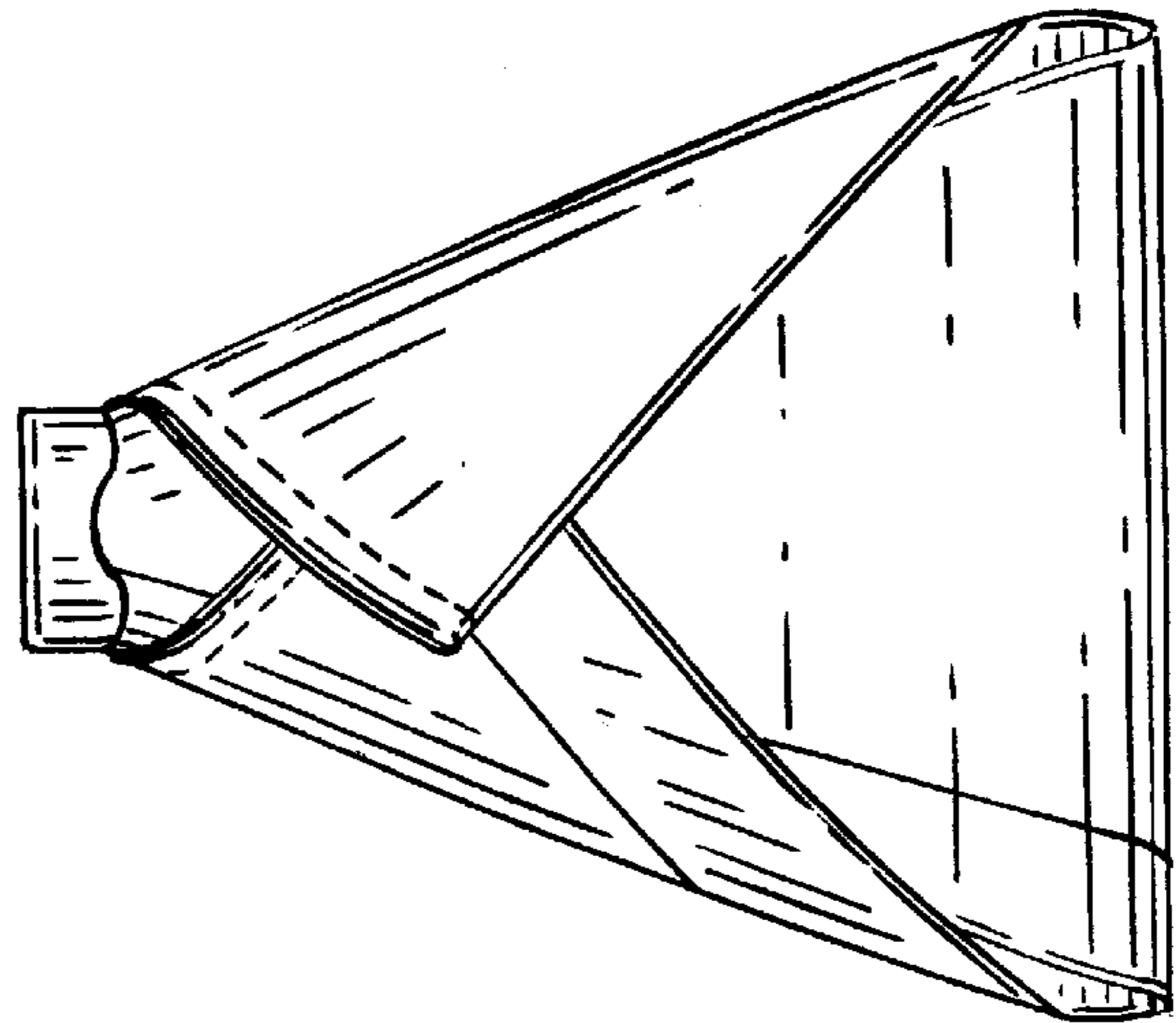

FIG. 3

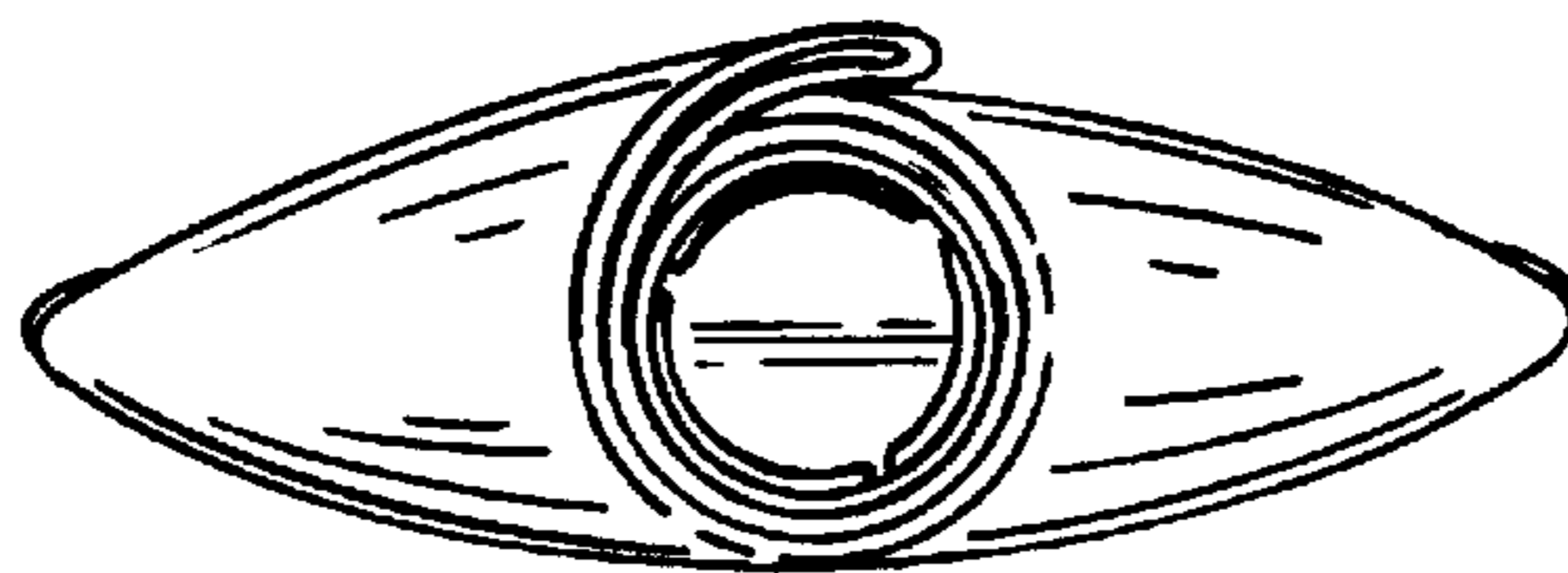

FIG. 4

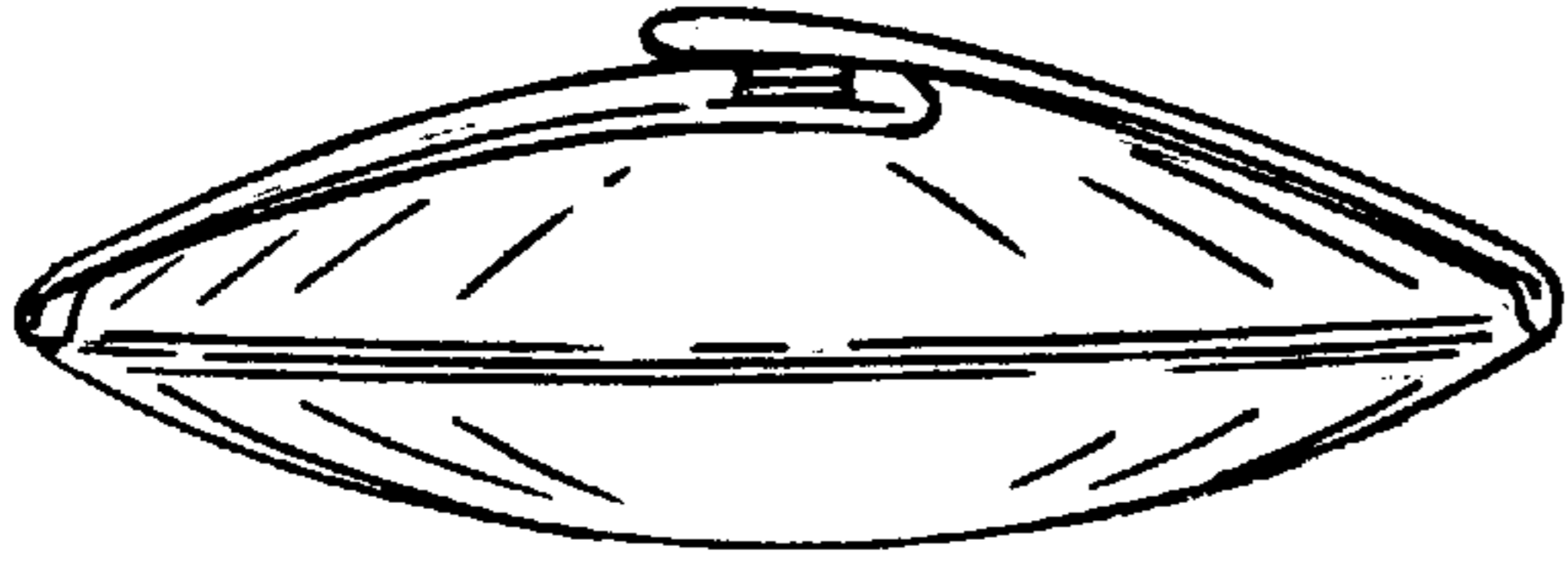

FIG. 5

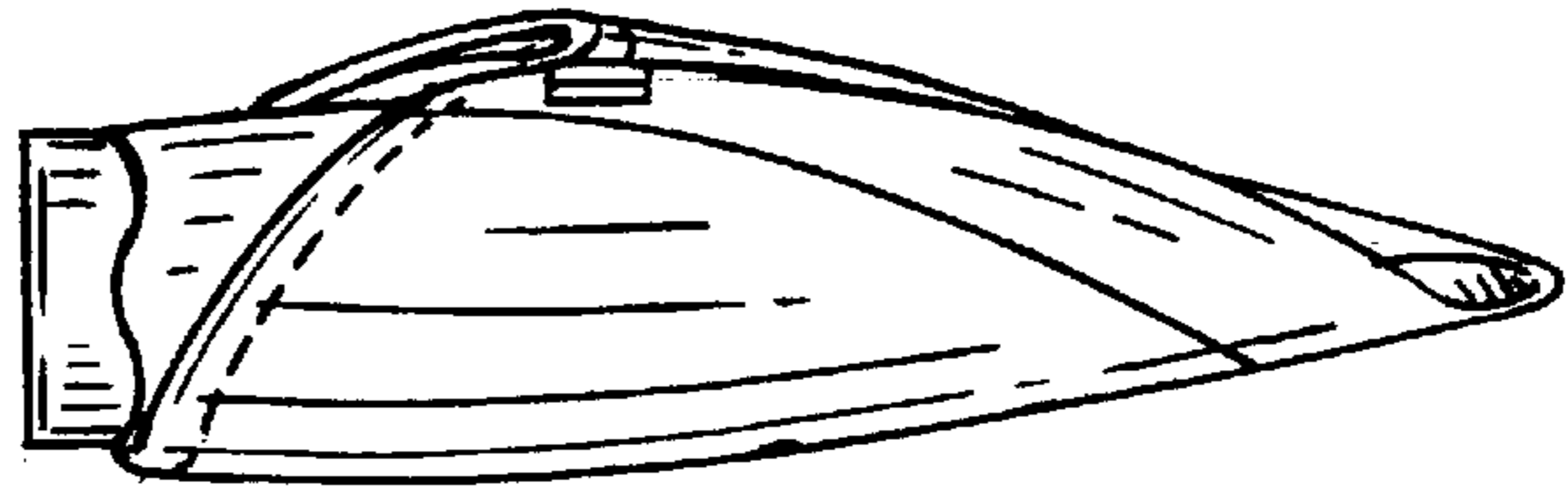

FIG. 6



FIG. 7

FIG. 8

