



US00D402159S

United States Patent [19] Laib

[11] Patent Number: **Des. 402,159**

[45] Date of Patent: ****Dec. 8, 1998**

[54] **BATTER BOWL**

[75] Inventor: **Douglas M. Laib**, Orlando, Fla.

[73] Assignee: **Dart Industries Inc.**, Orlando, Fla.

[**] Term: **14 Years**

[21] Appl. No.: **72,079**

[22] Filed: **Jun. 18, 1997**

[51] **LOC (6) Cl.** **07-01**

[52] **U.S. Cl.** **D7/538; D7/543; D7/319; D7/317**

[58] **Field of Search** **D7/622, 543, 505, D7/536, 548, 300, 312, 316, 317, 318, 319, 590, 598, 369, 538; 272/465.1, 473.1; 99/279; 220/574**

[56] **References Cited**

U.S. PATENT DOCUMENTS

D. 194,622	2/1963	Swett	D7/317 X
D. 236,409	8/1975	Cyren	.	
D. 237,934	12/1975	Fairthorne	D7/312
D. 284,344	6/1986	Gecchelin	.	
D. 285,521	9/1986	Urich	D7/318 X
D. 322,007	12/1991	Adams et al.	D7/317
D. 342,642	12/1993	Brazis et al.	.	
D. 346,092	4/1994	Van De Velde	D7/538
D. 360,556	7/1995	DeCoster	D7/318
D. 362,594	9/1995	McEntee	.	
D. 365,492	12/1995	Rorke	D7/319
D. 371,939	7/1996	Rigney	.	

D. 373,932	9/1996	Onneweer	.	
D. 381,238	7/1997	Joergensen	D7/319
1,345,457	7/1920	Olson	.	
1,688,992	10/1928	Smith	D7/536 X
2,802,499	8/1957	Tupper	.	
2,858,118	10/1958	Perkins	.	
3,487,200	12/1969	Waller et al.	D7/312 X
4,832,225	5/1989	Benjamin	.	
4,921,114	5/1990	Rome	.	
5,169,023	12/1992	Heiberg et al.	.	
5,363,978	11/1994	Molo	.	
5,419,454	5/1995	Stowell et al.	220/574

Primary Examiner—M. N. Pandozzi
Attorney, Agent, or Firm—John A. Doninger

[57] **CLAIM**

The ornamental design for a batter bowl, as shown and described.

DESCRIPTION

FIG. 1 is a top, rear and side perspective view of a batter bowl showing my new design;
FIG. 2 is an exploded perspective view thereof;
FIG. 3 is a top plan view thereof;
FIG. 4 is a bottom plan view thereof;
FIG. 5 is a front elevation view thereof;
FIG. 6 is a rear elevation view thereof;
FIG. 7 is a right side view thereof;
FIG. 8 is a left side view thereof; and,
FIG. 9 is a cross-section view thereof, taken on line 9—9 in FIG. 3.

1 Claim, 6 Drawing Sheets

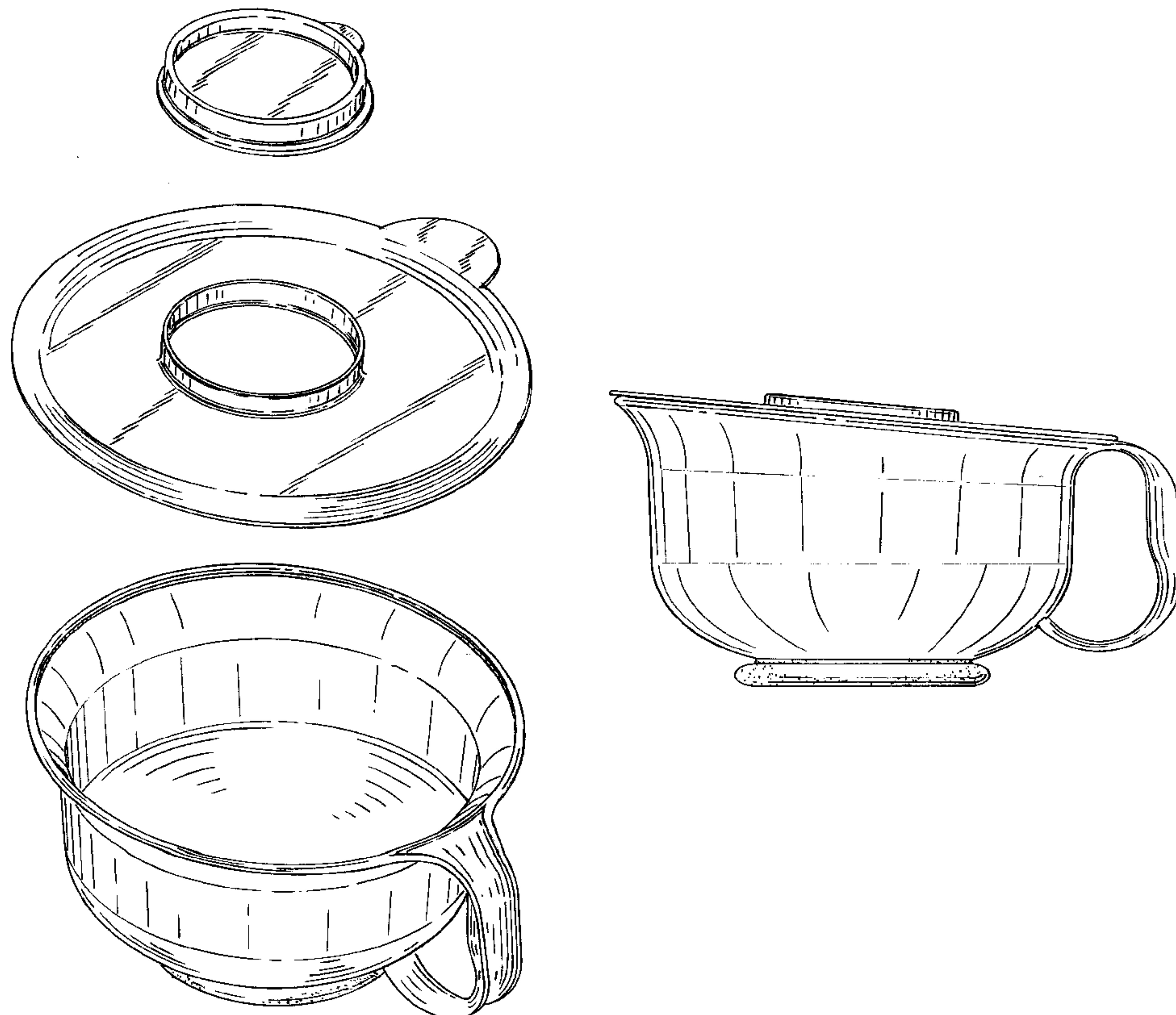

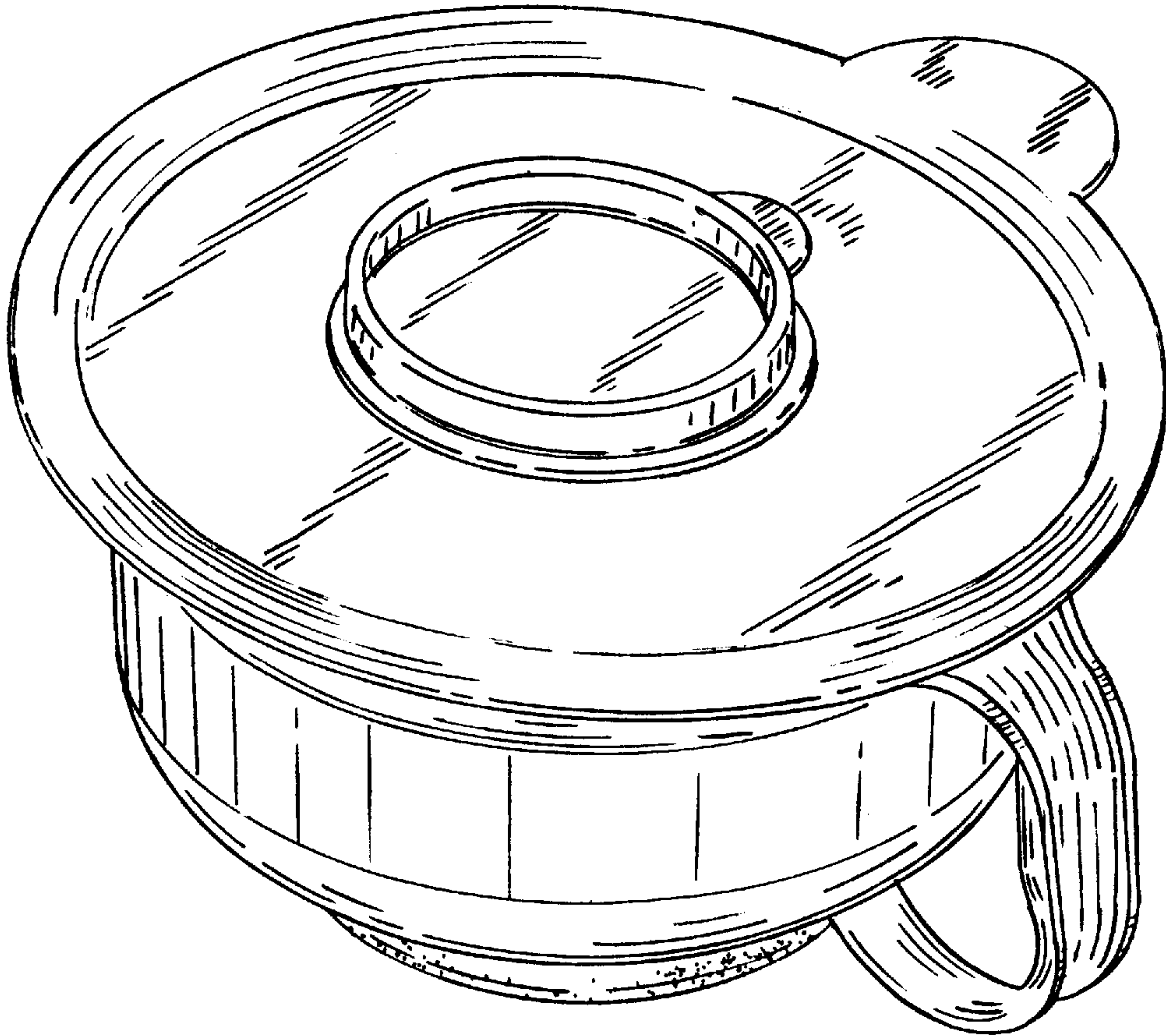

FIG. 1

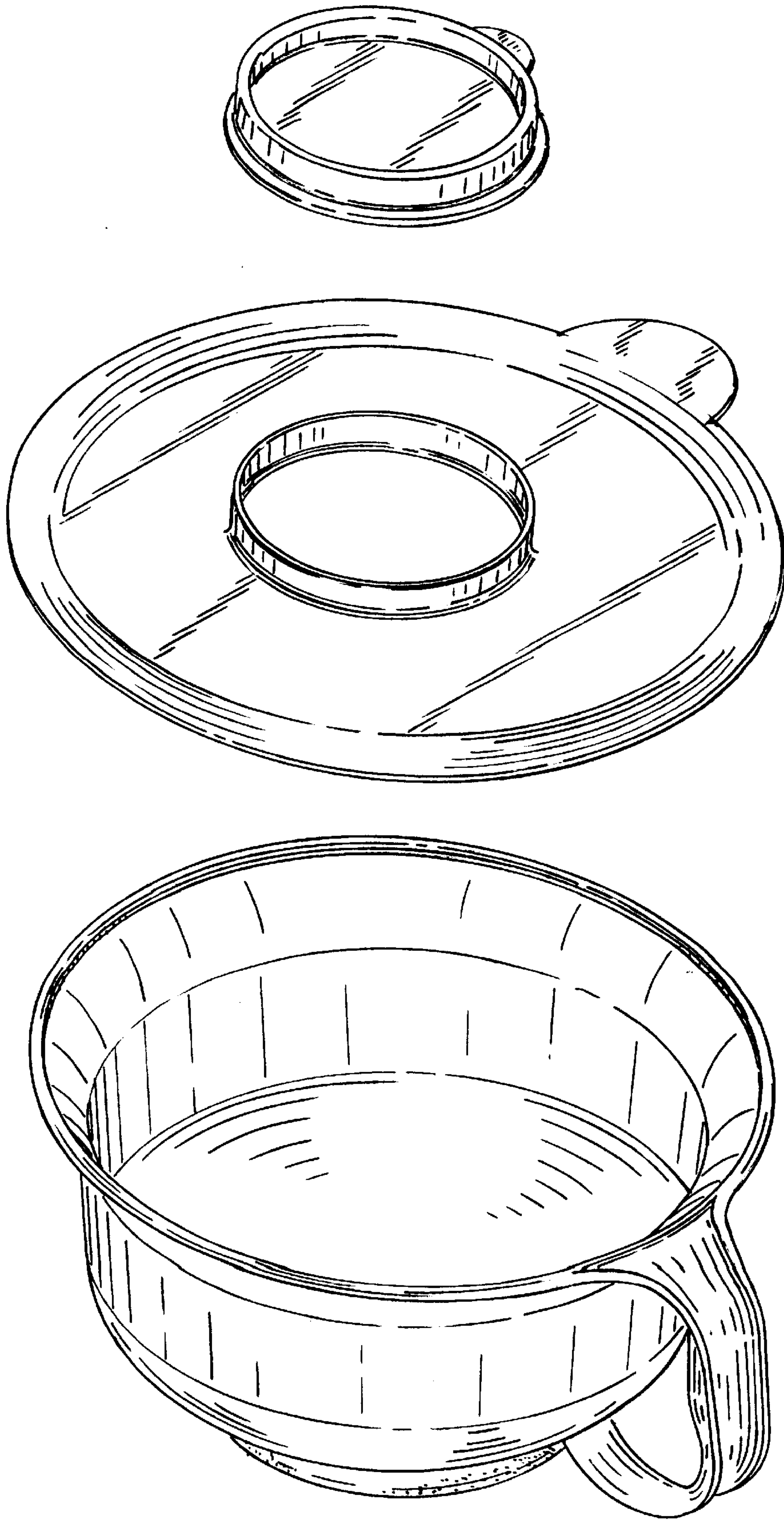
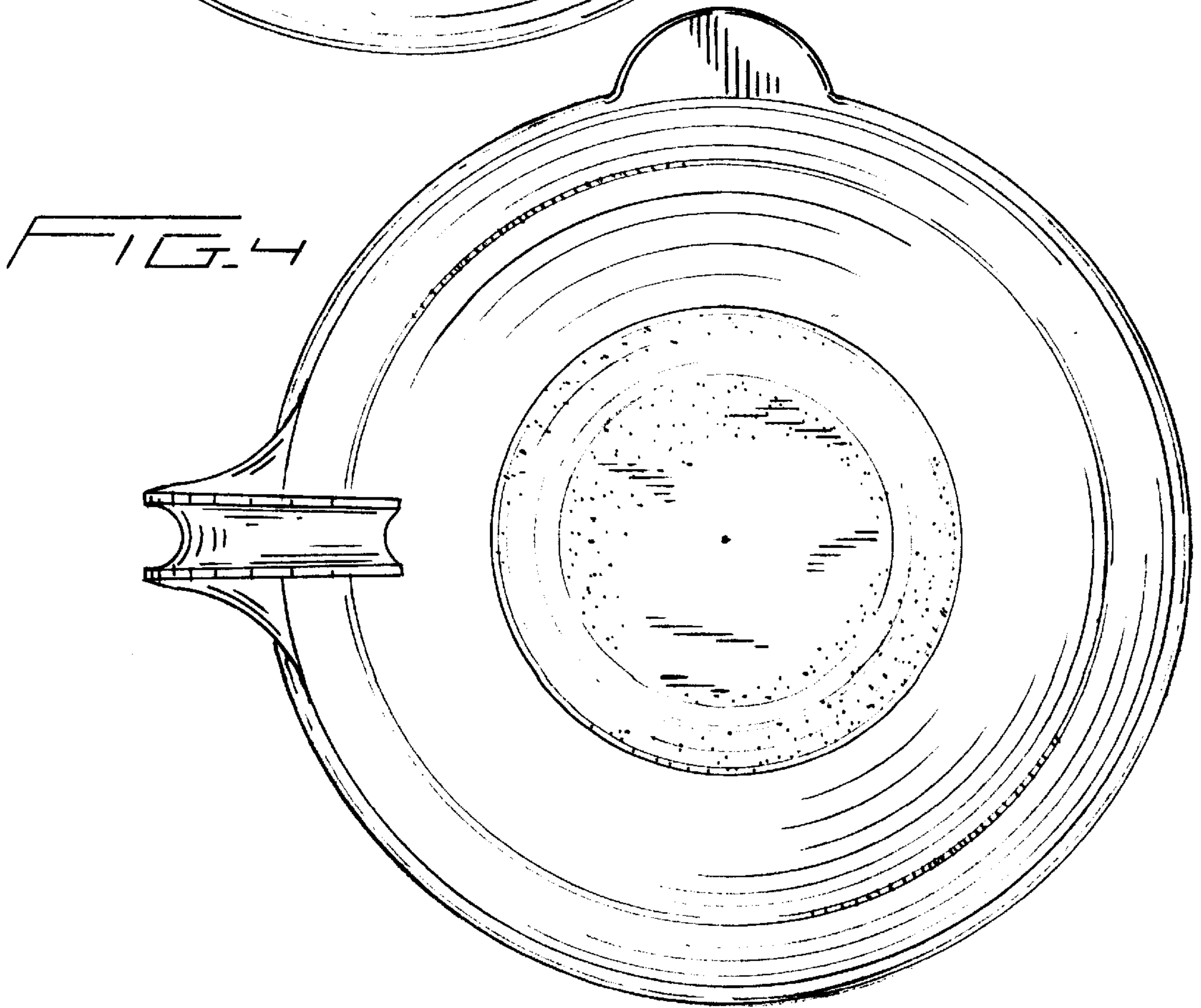
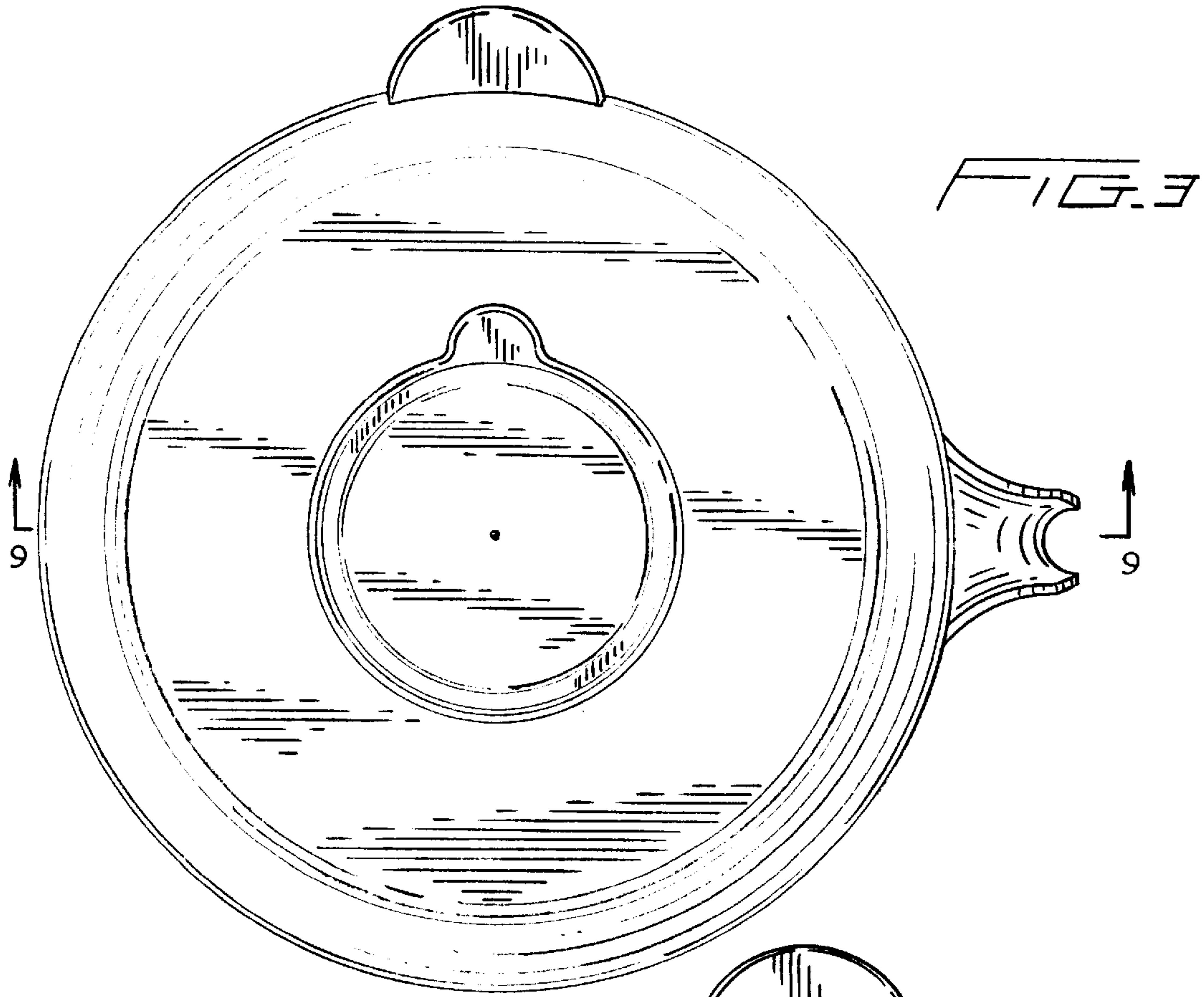

FIG. 2



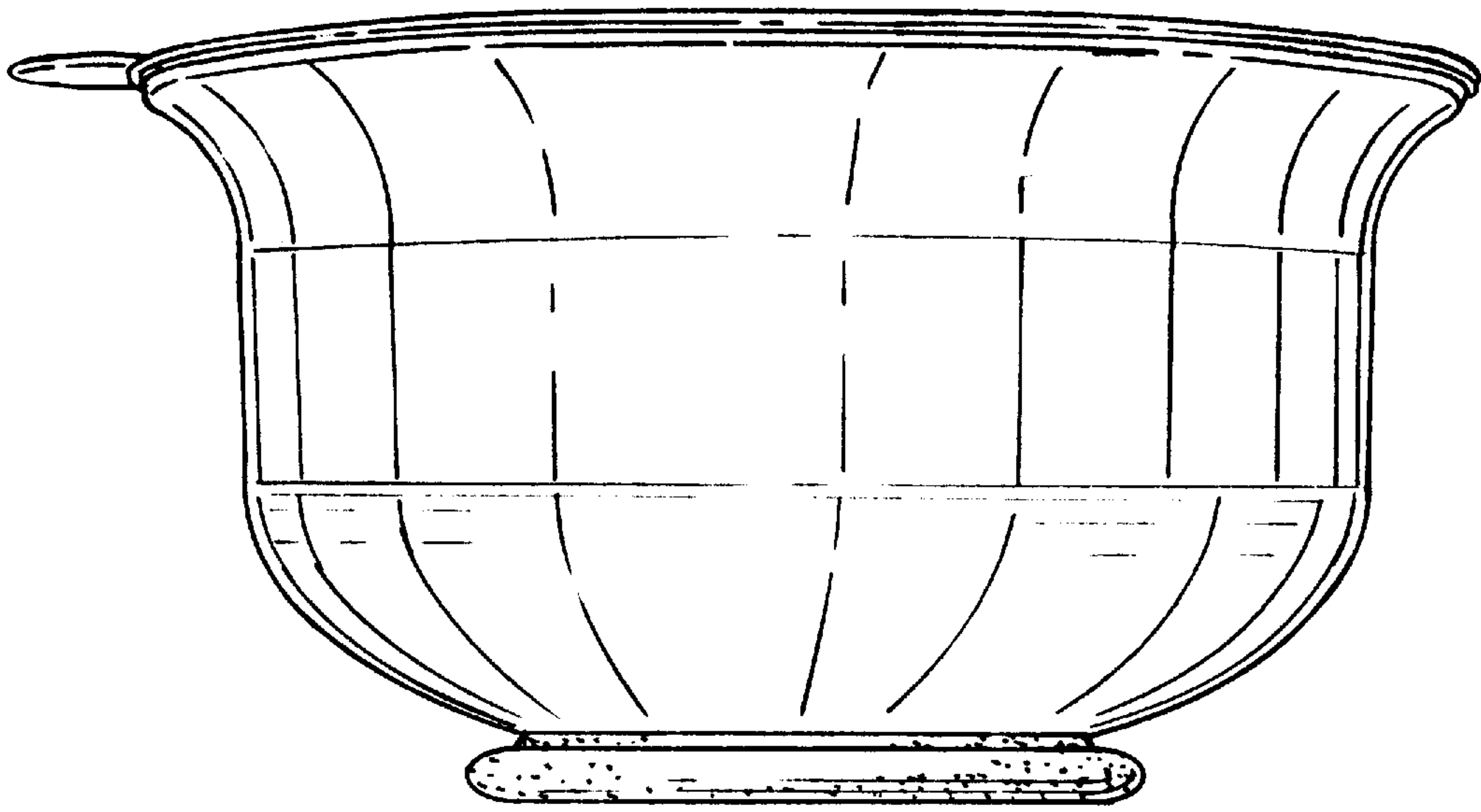

FIG. 5

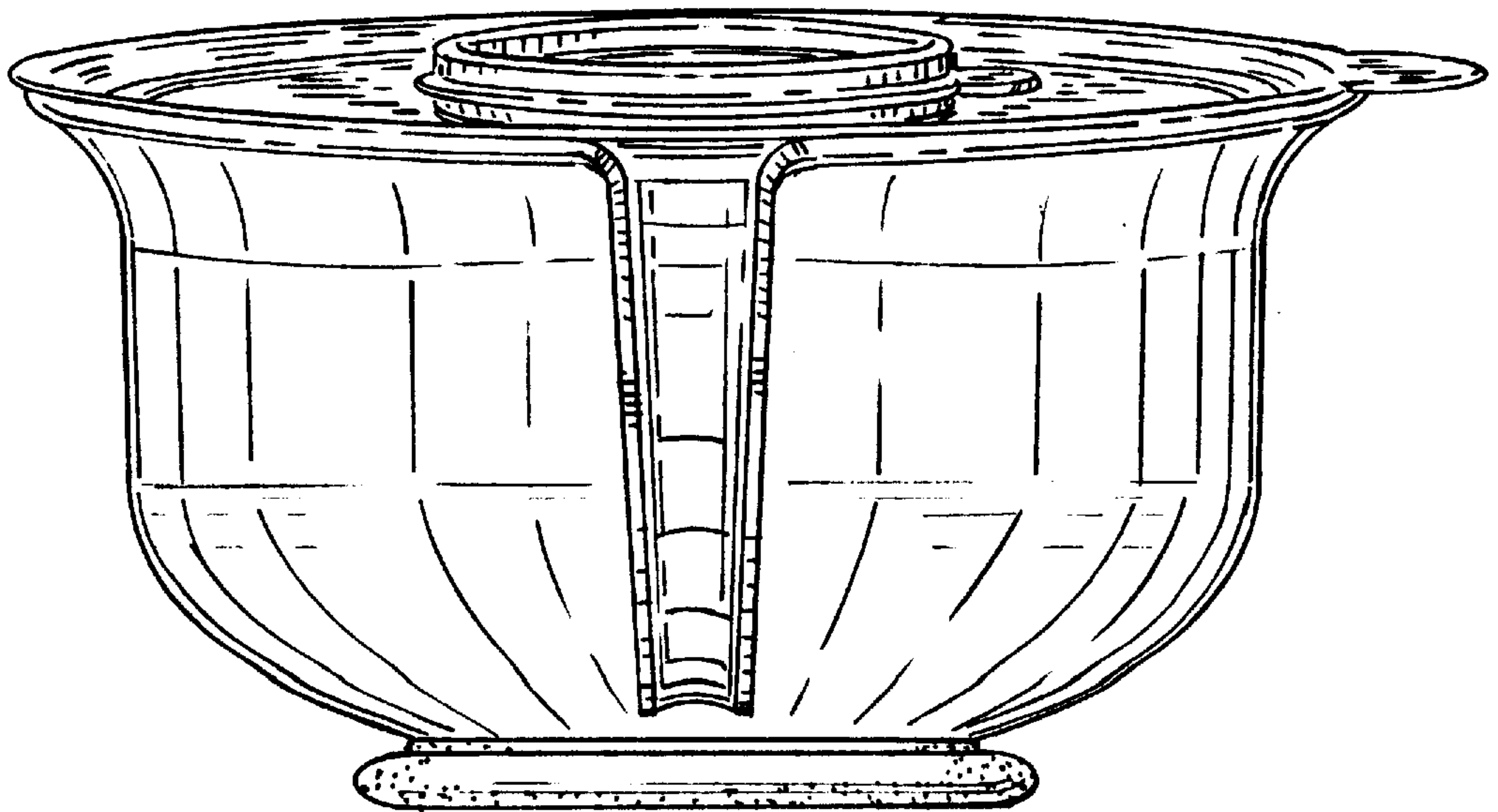

FIG. 6

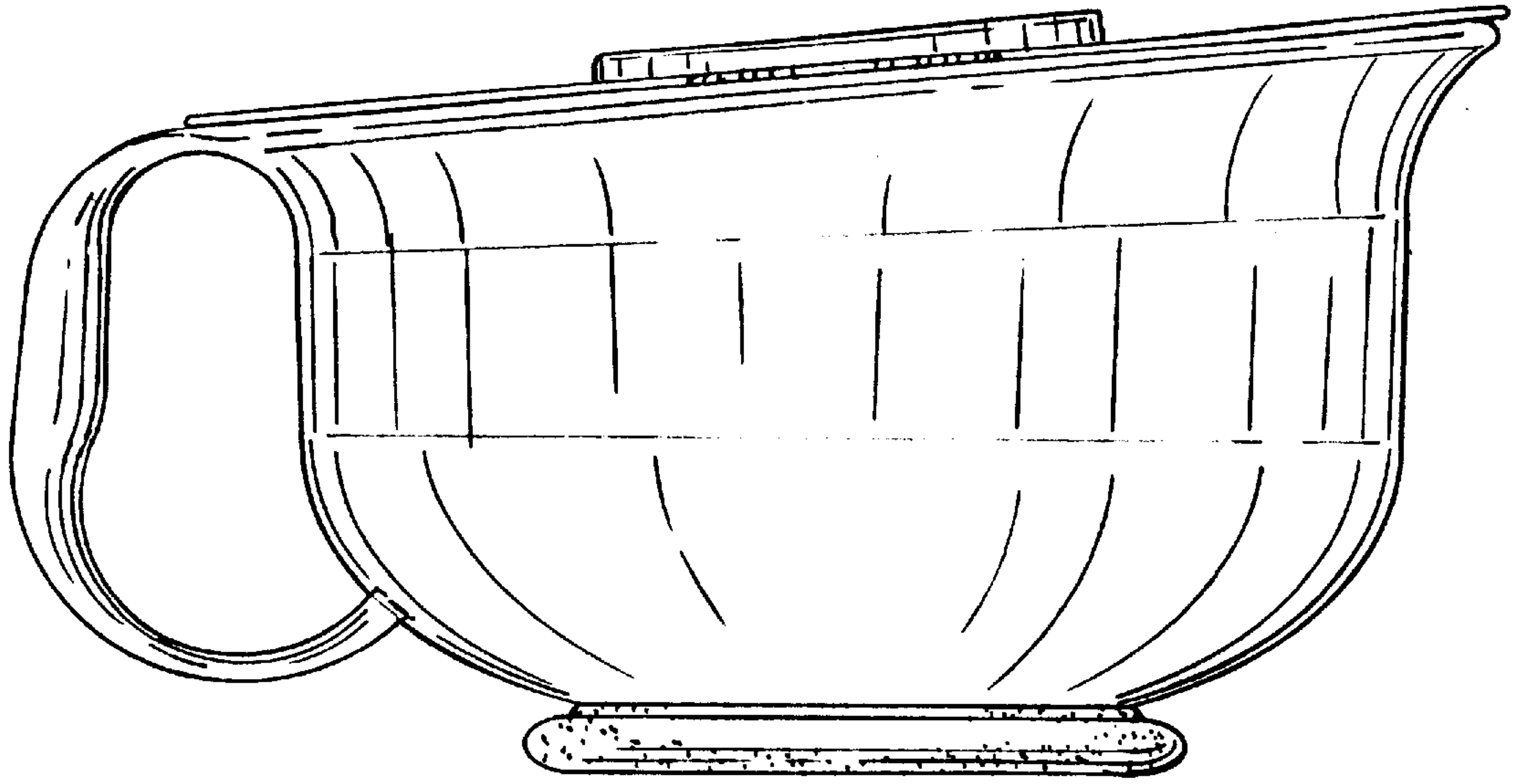

FIG. 7

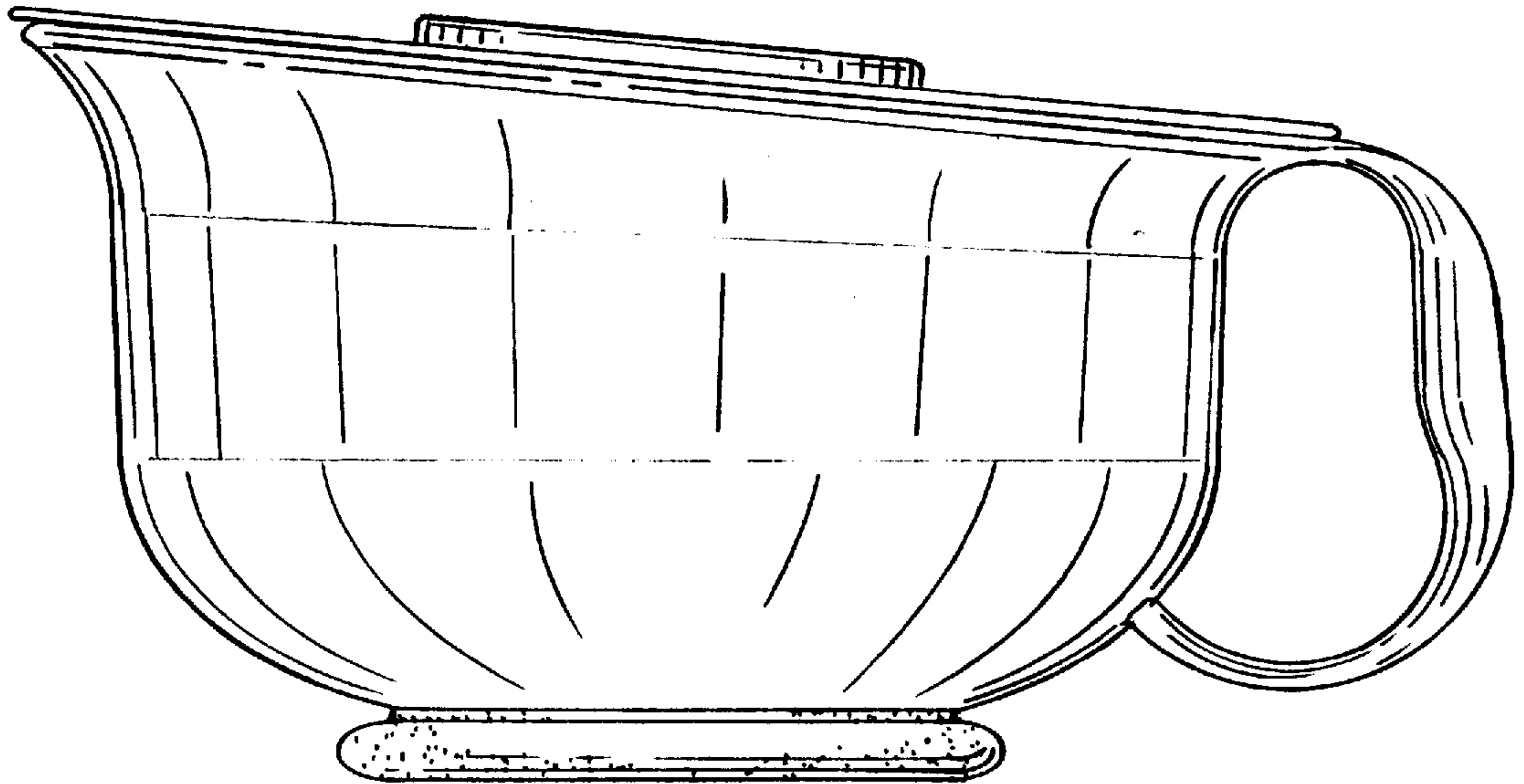

FIG. 8

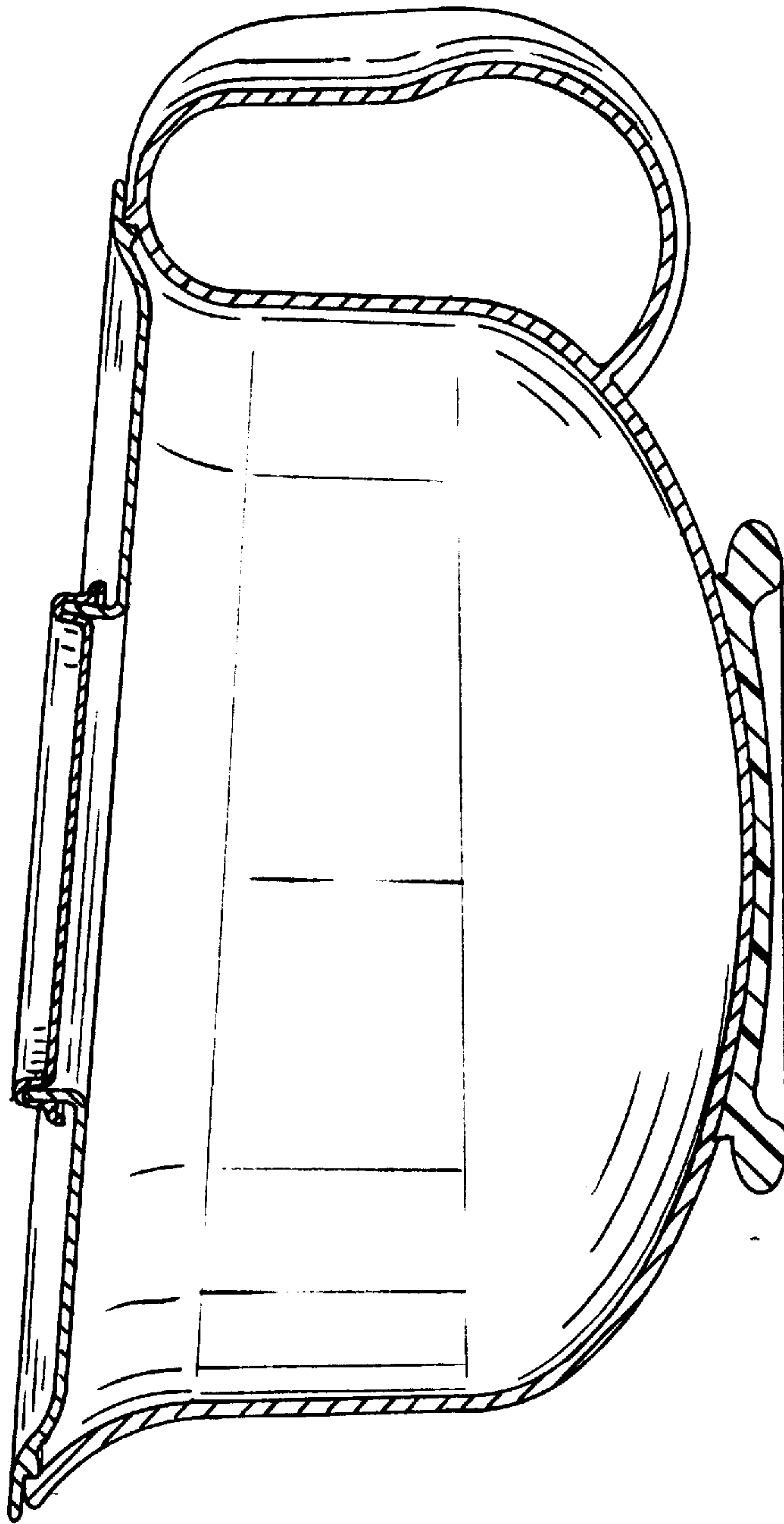

FIG. 9