



US00D402155S

United States Patent [19] McDew

[11] Patent Number: Des. 402,155

[45] Date of Patent: **Dec. 8, 1998

[54] DEEP FAT FRYER

[76] Inventor: Jesse McDew, 919 Carmelita Ave.,
Sacramento, Calif. 95838

[**] Term: 14 Years

[21] Appl. No.: 74,077

[22] Filed: Jul. 28, 1997

[51] LOC (6) Cl. 07-02

[52] U.S. Cl. D7/354

[58] Field of Search D7/323, 332, 334,
D7/354; 99/403

[56] References Cited

U.S. PATENT DOCUMENTS

D. 208,179	7/1967	King et al.	D7/334
D. 230,004	1/1974	Moltere	D7/334
D. 268,391	3/1983	Craco	D7/332
3,722,498	3/1973	Kimbrough	99/403 X
4,905,664	3/1990	Dunham	99/403 X
5,642,660	7/1997	Killgore et al.	99/403

Primary Examiner—Caron D. Veynar
Attorney, Agent, or Firm—Mark C. Jacobs, Esq.

[57] CLAIM

The ornamental design for deep fat fryer, as shown and described.

DESCRIPTION

FIG. 1 is a top perspective view of a deep fat fryer showing my new design;

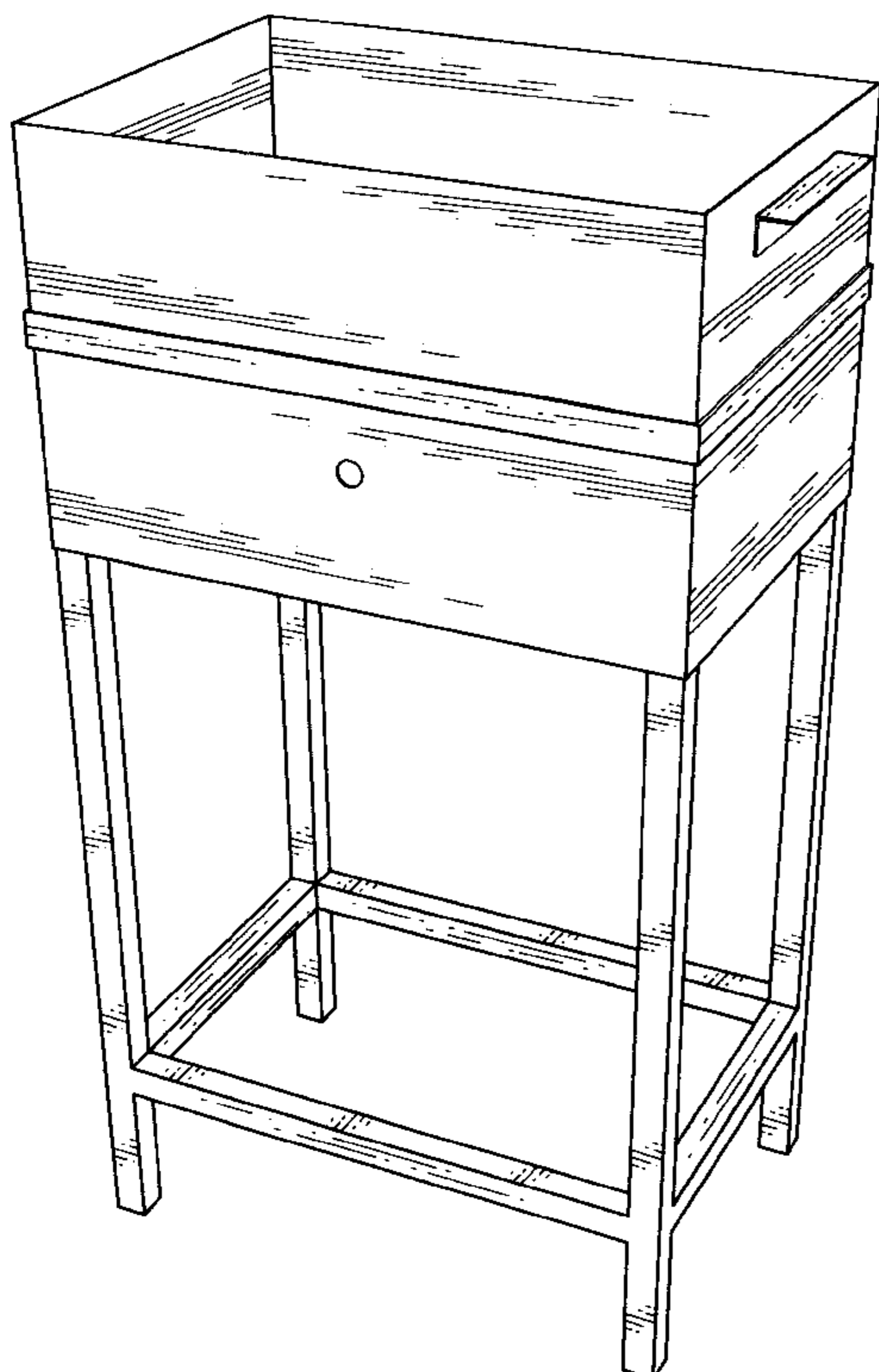

FIG. 2 is a top plan view;

FIG. 3 is a right side elevational view thereof. The left side is a mirror image;

FIG. 4 is a front elevational view of the first embodiment of this design. The rear elevation is a mirror image of this view, but without the burner control shown in dashed line;

FIG. 5 is a bottom plan view of the apparatus of FIG.1;

FIG. 6 is a top plan view without the removable tray for ease of illustration;

FIG. 7 is an exploded perspective view of the tray and the burner sections of the apparatus of FIG. 1, prior to engagement;

FIG. 8 is a perspective view of a second embodiment of the claimed design;

FIG. 9 is a left side elevational view of the second embodiment of this design. The right side view is a mirror image thereof;

FIG. 10 is a front elevational view of the first embodiment of this design. The rear elevation is a mirror image of this view but without the burner control shown in dashed line;

FIG. 11 is a bottom plan view of the second embodiment of this design;

FIG. 12 is a top plan view without the removable tray for ease of illustration; and,

FIG. 13 is an exploded perspective view of the components forming the apparatus of the second embodiment of this design.

The broken line showing of handles, burner controls, burners and wheels in FIGS.4, 7, 10 and 13 are for illustrative purposes only and forms no part of the claim design.

1 Claim, 5 Drawing Sheets

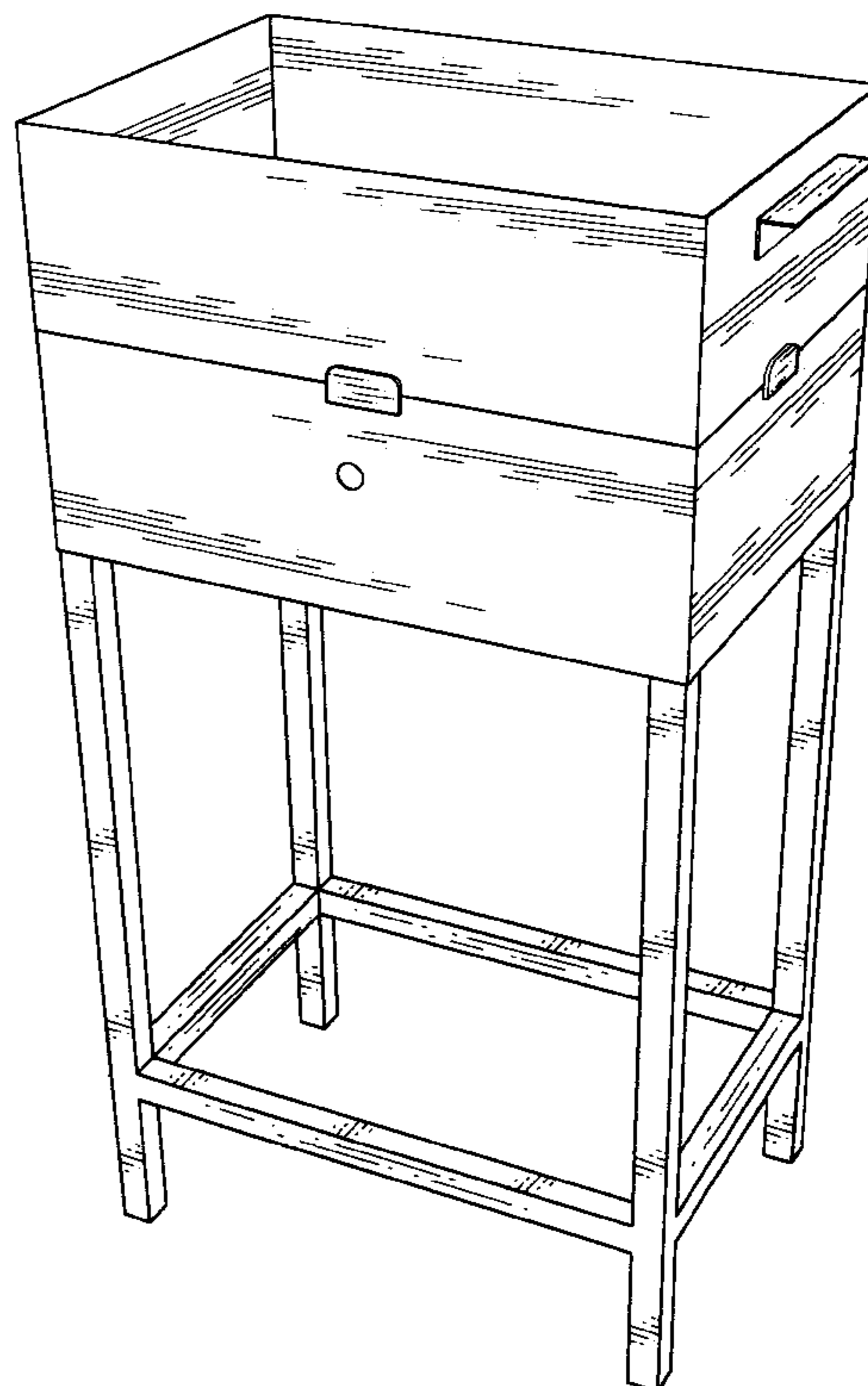

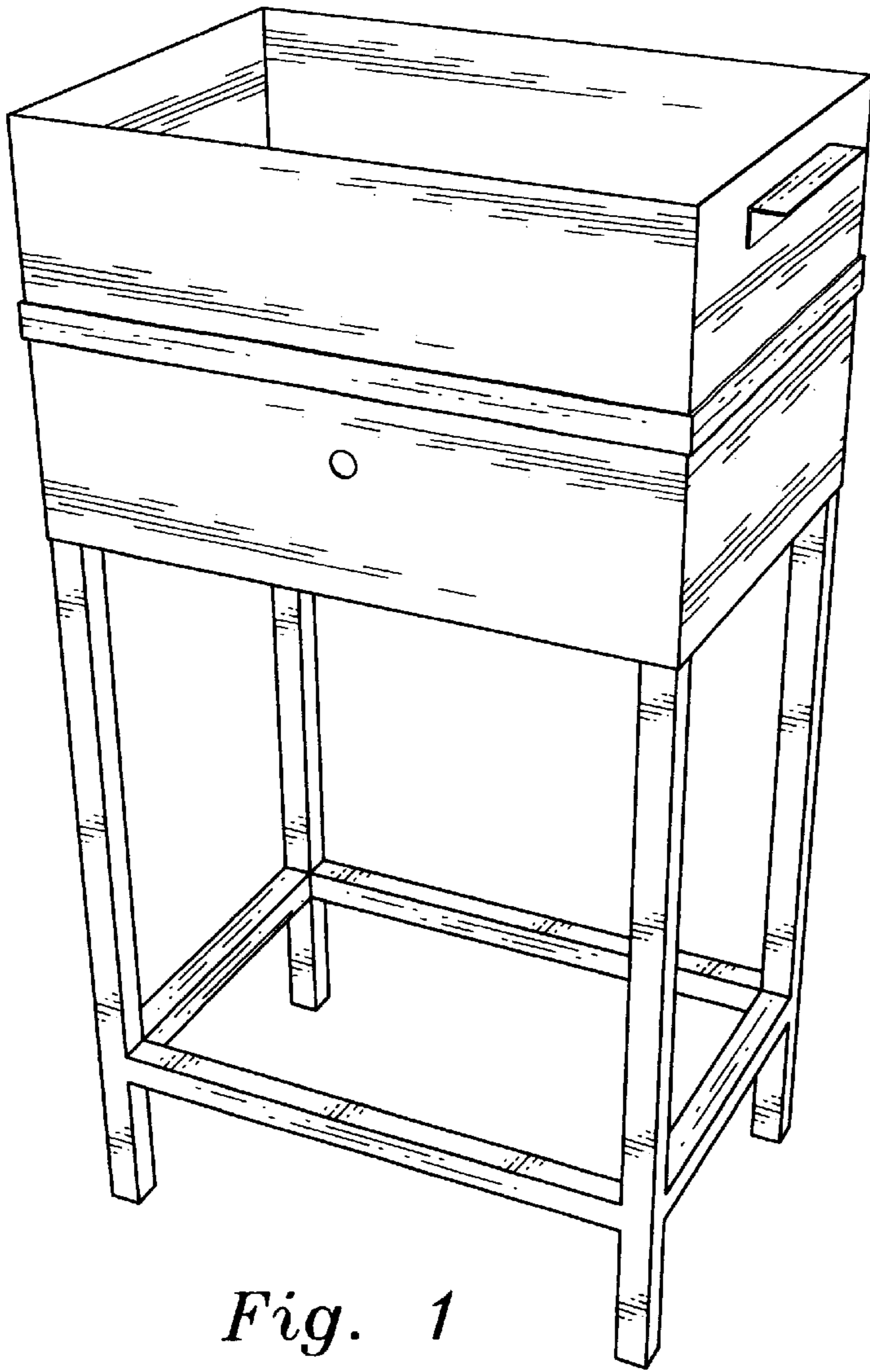

Fig. 1

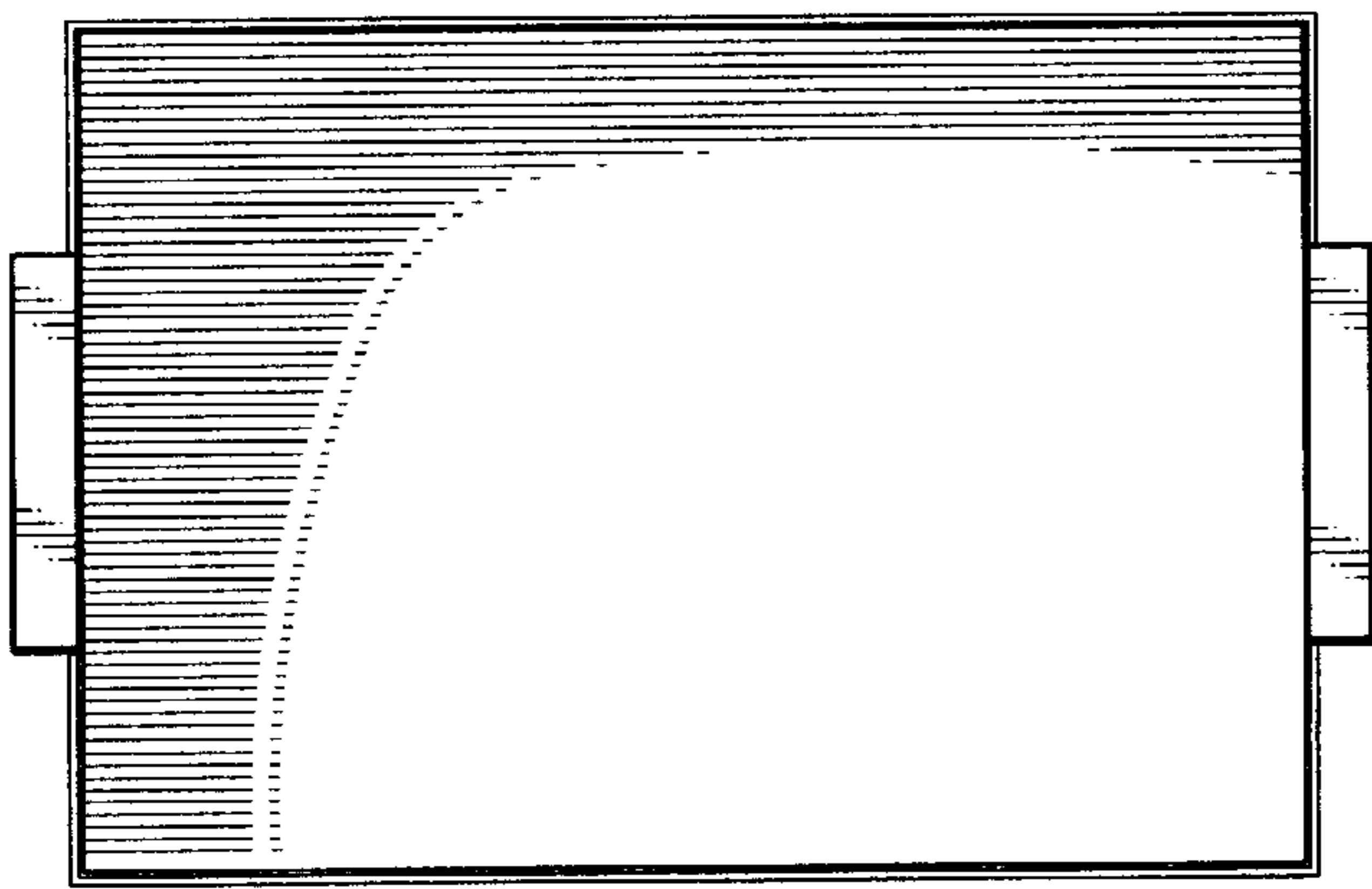

Fig. 2

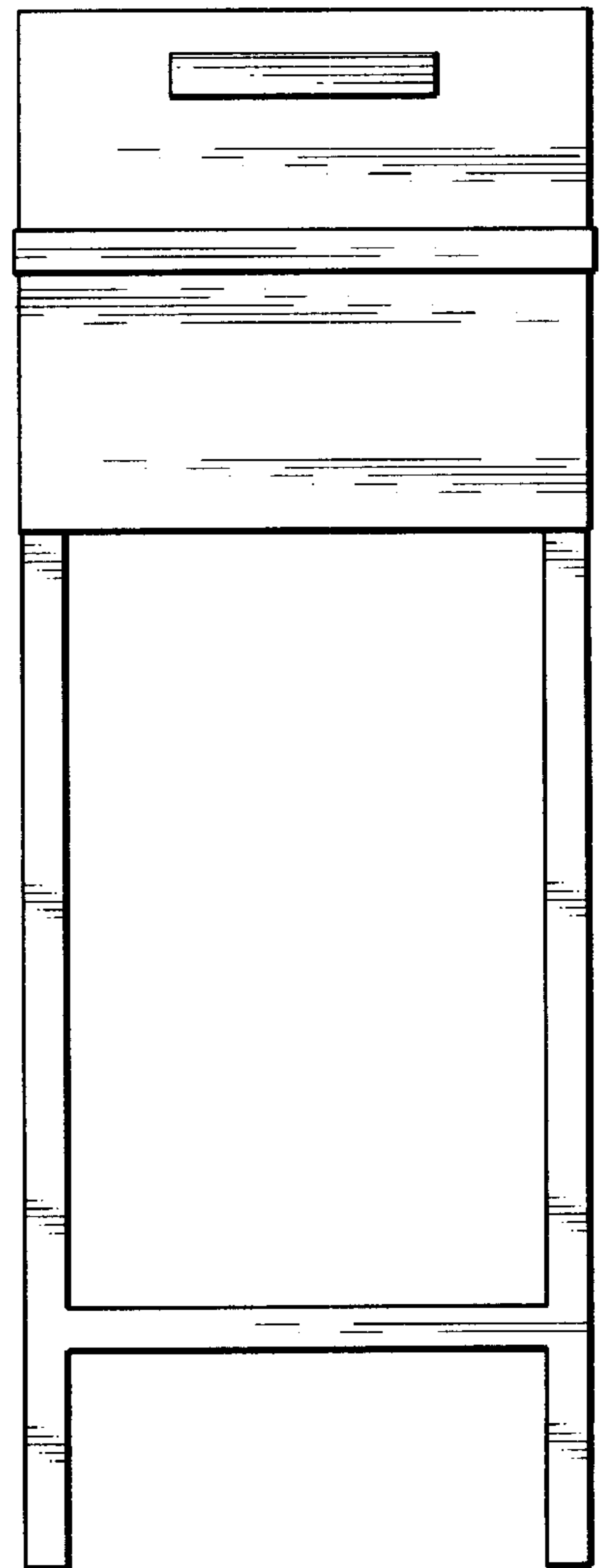

Fig. 3

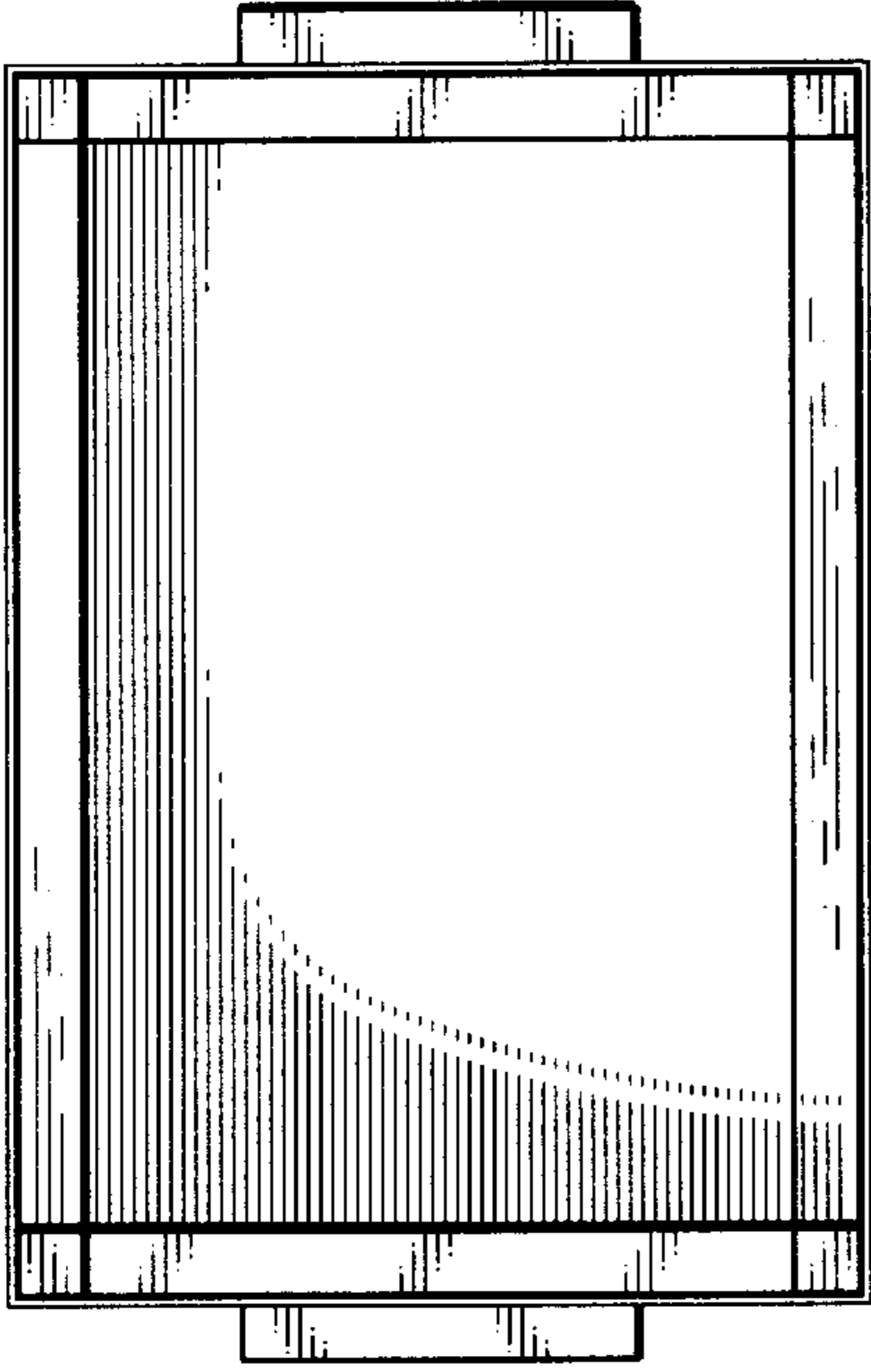

Fig. 5

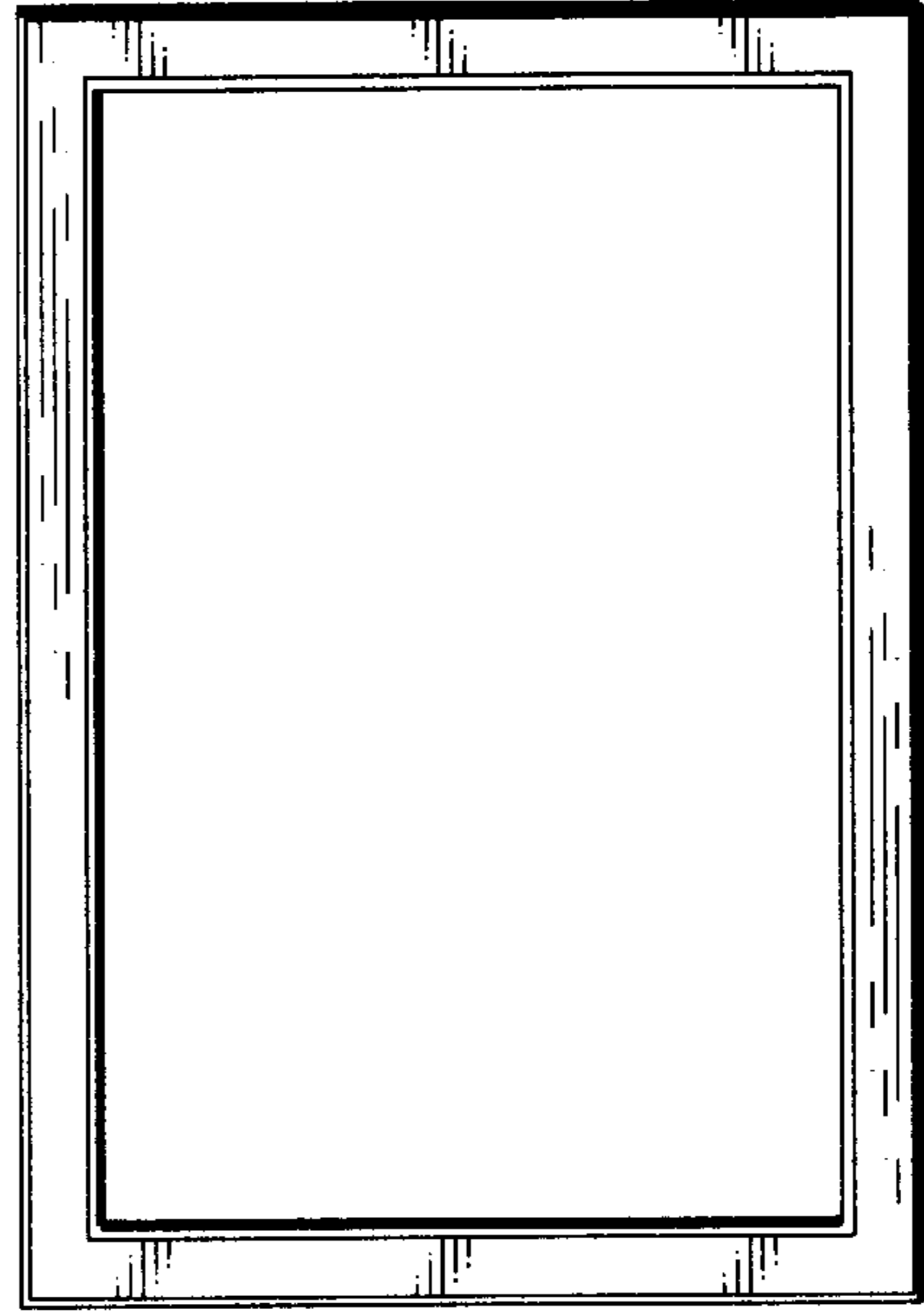

Fig. 6

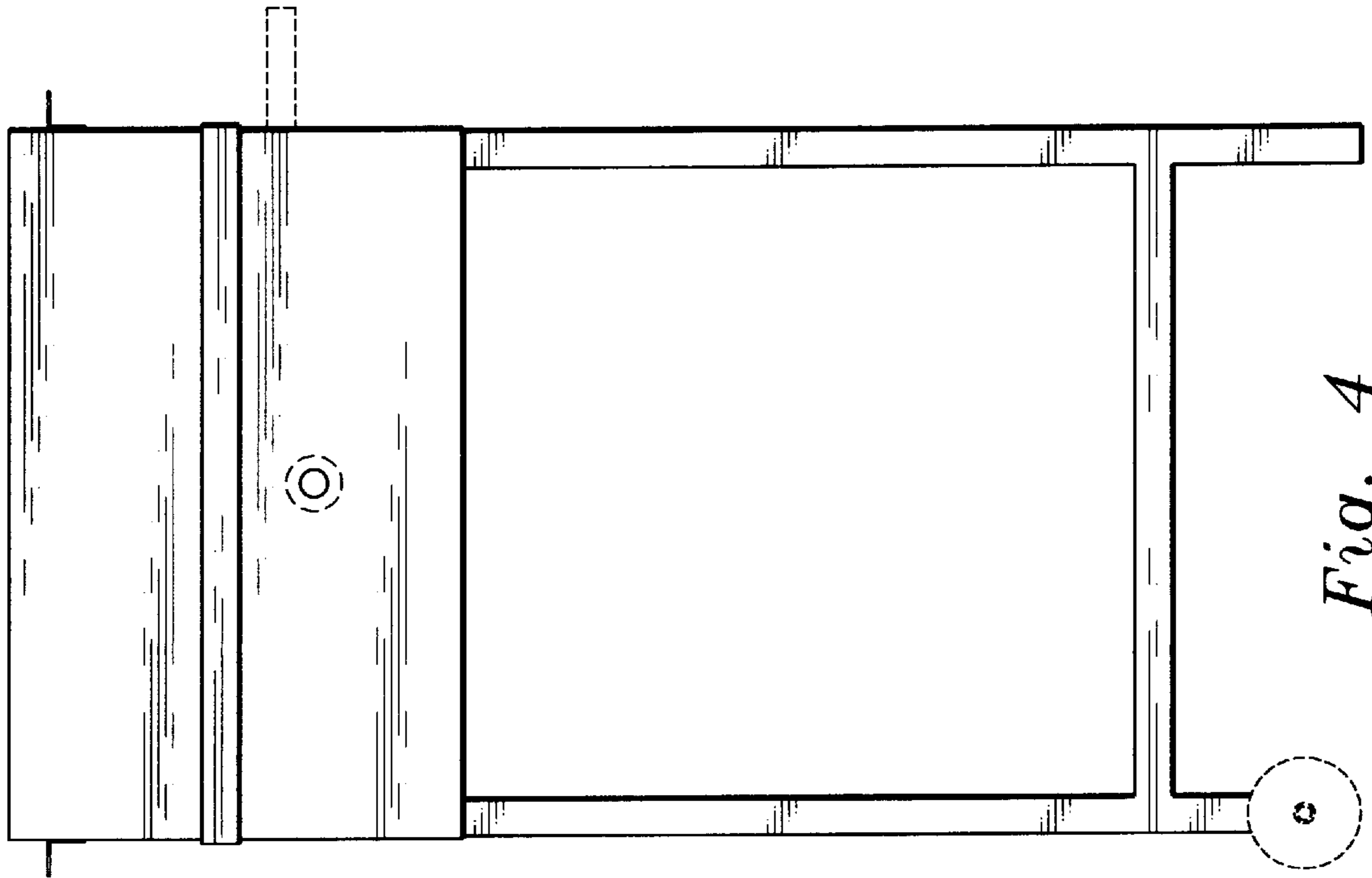

Fig. 4

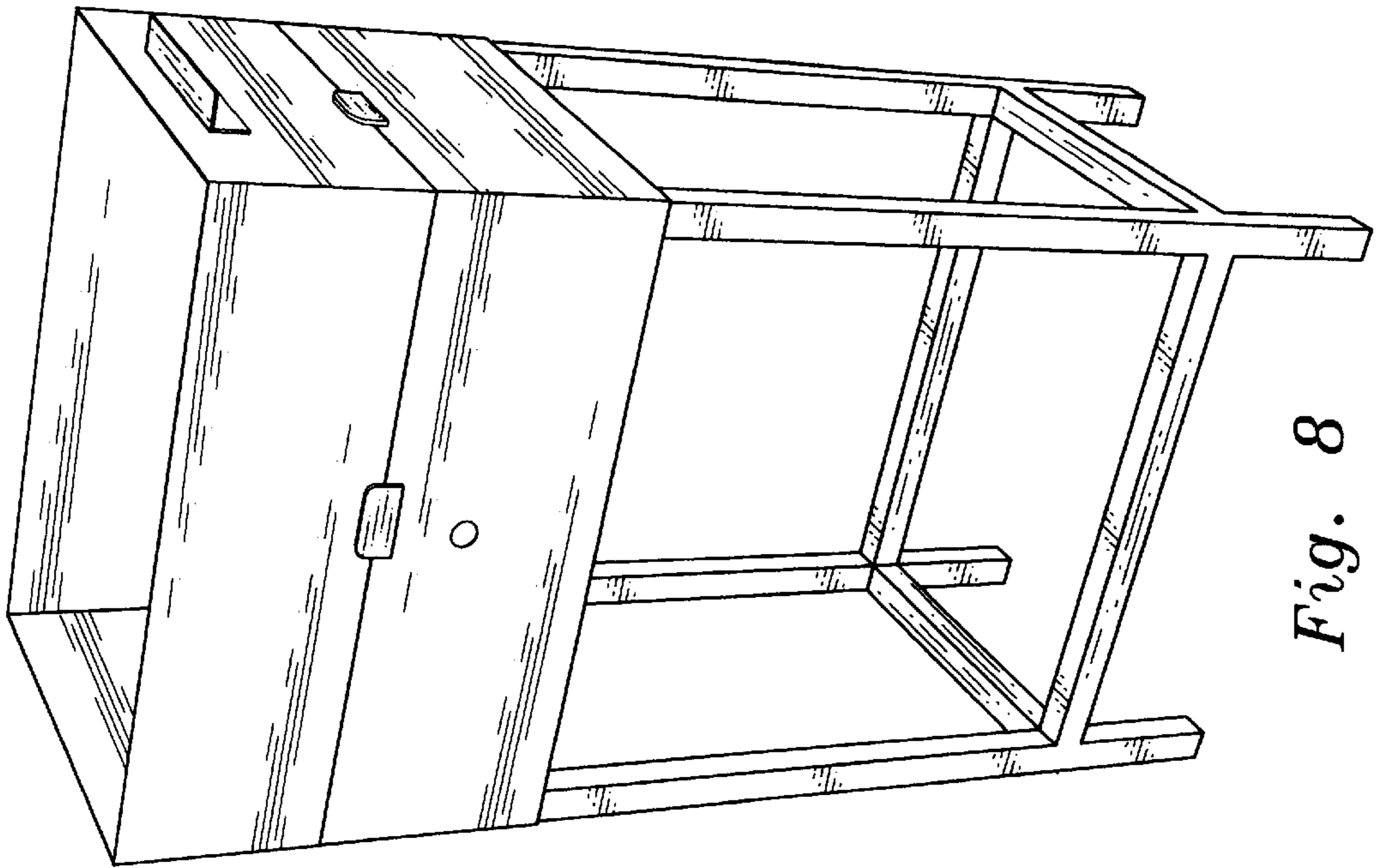

Fig. 8

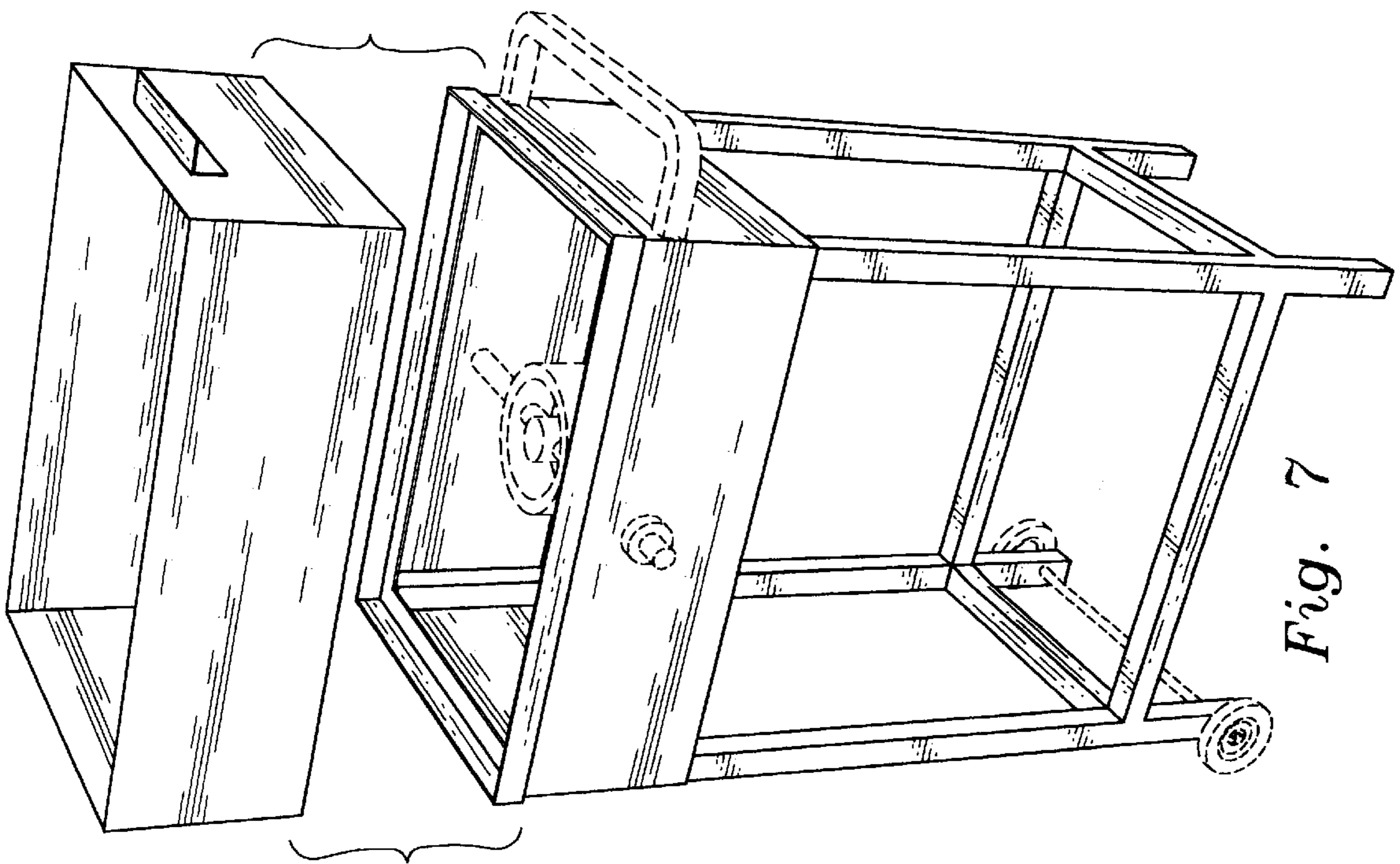

Fig. 7

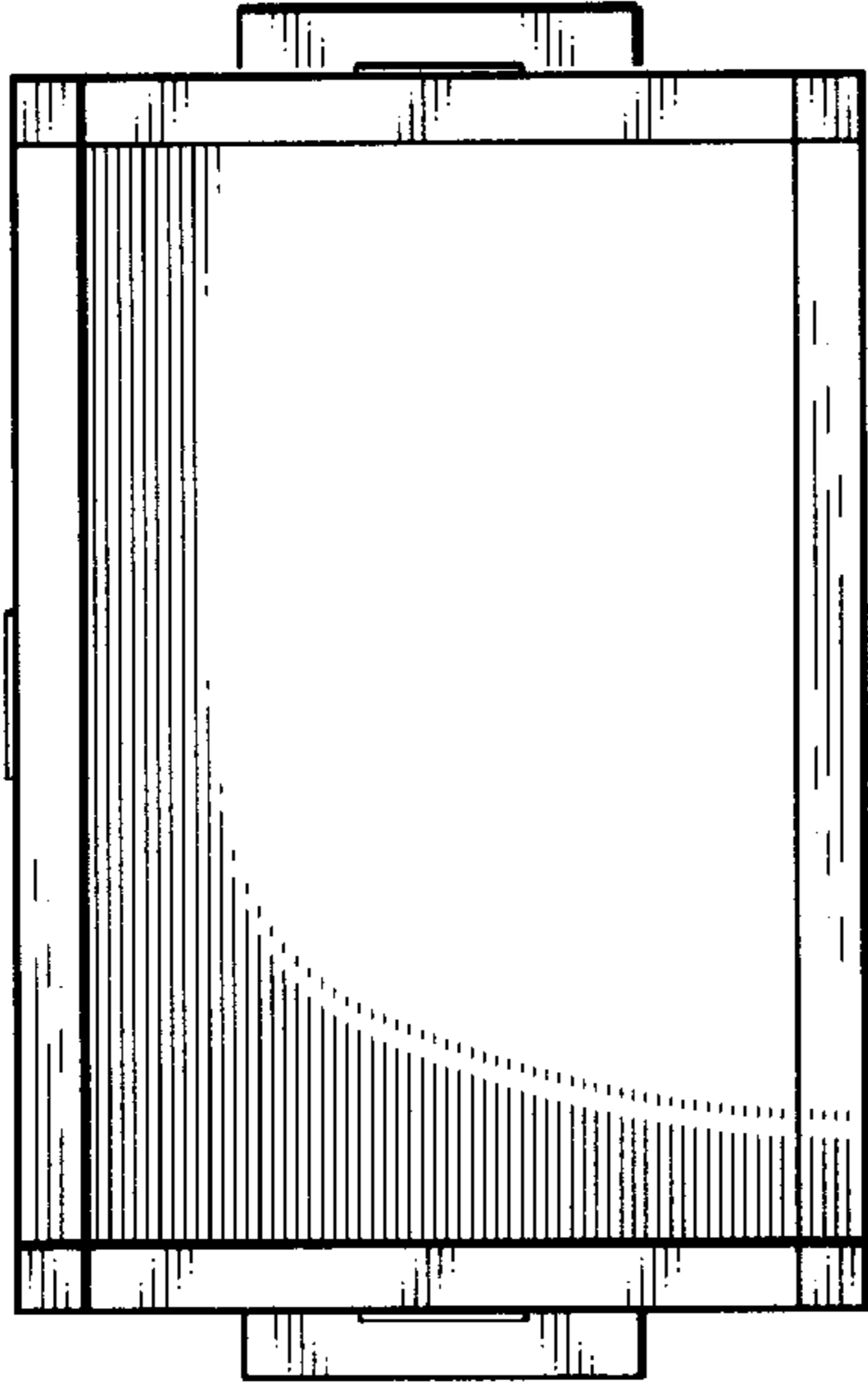

Fig. 11

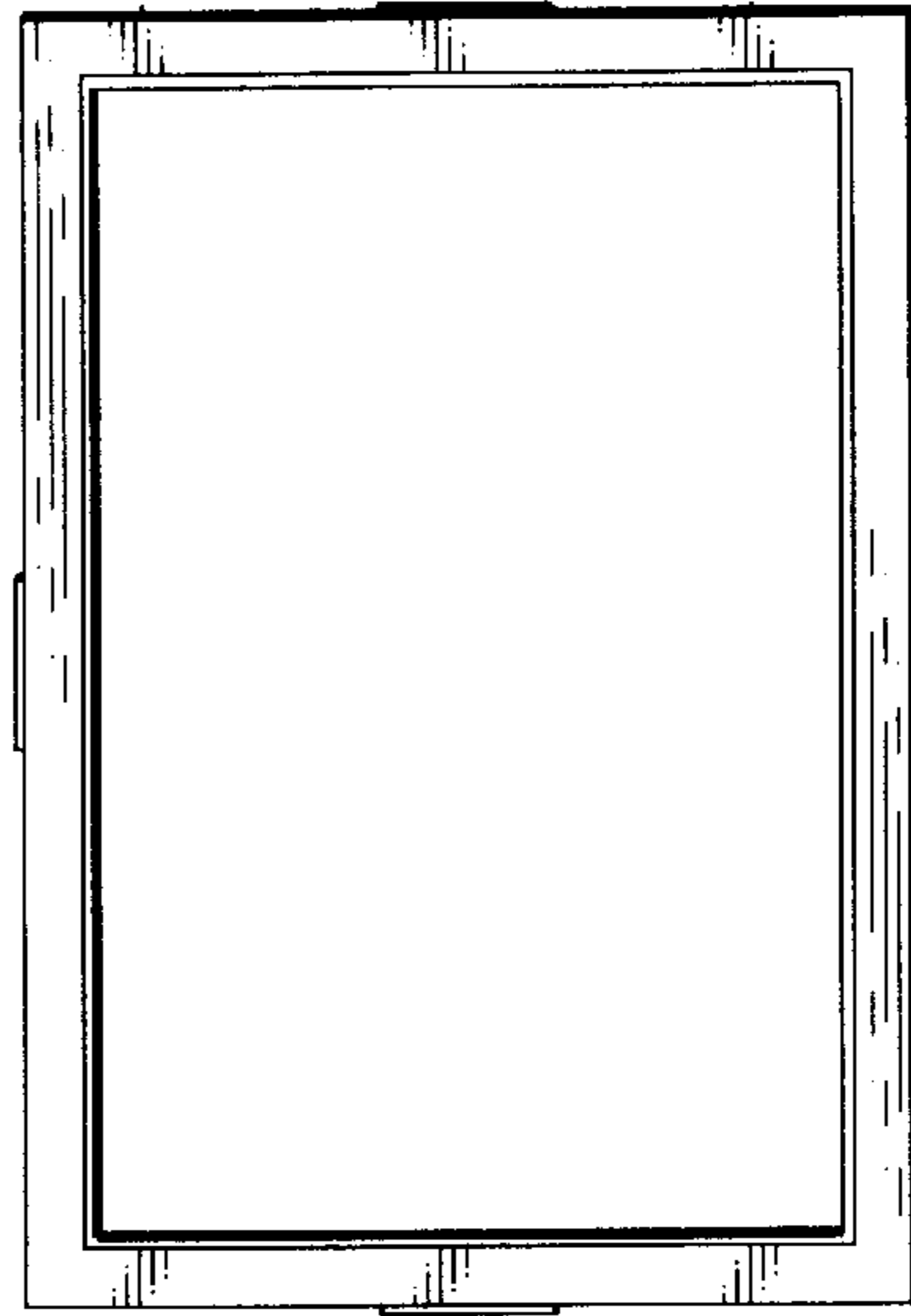

Fig. 12

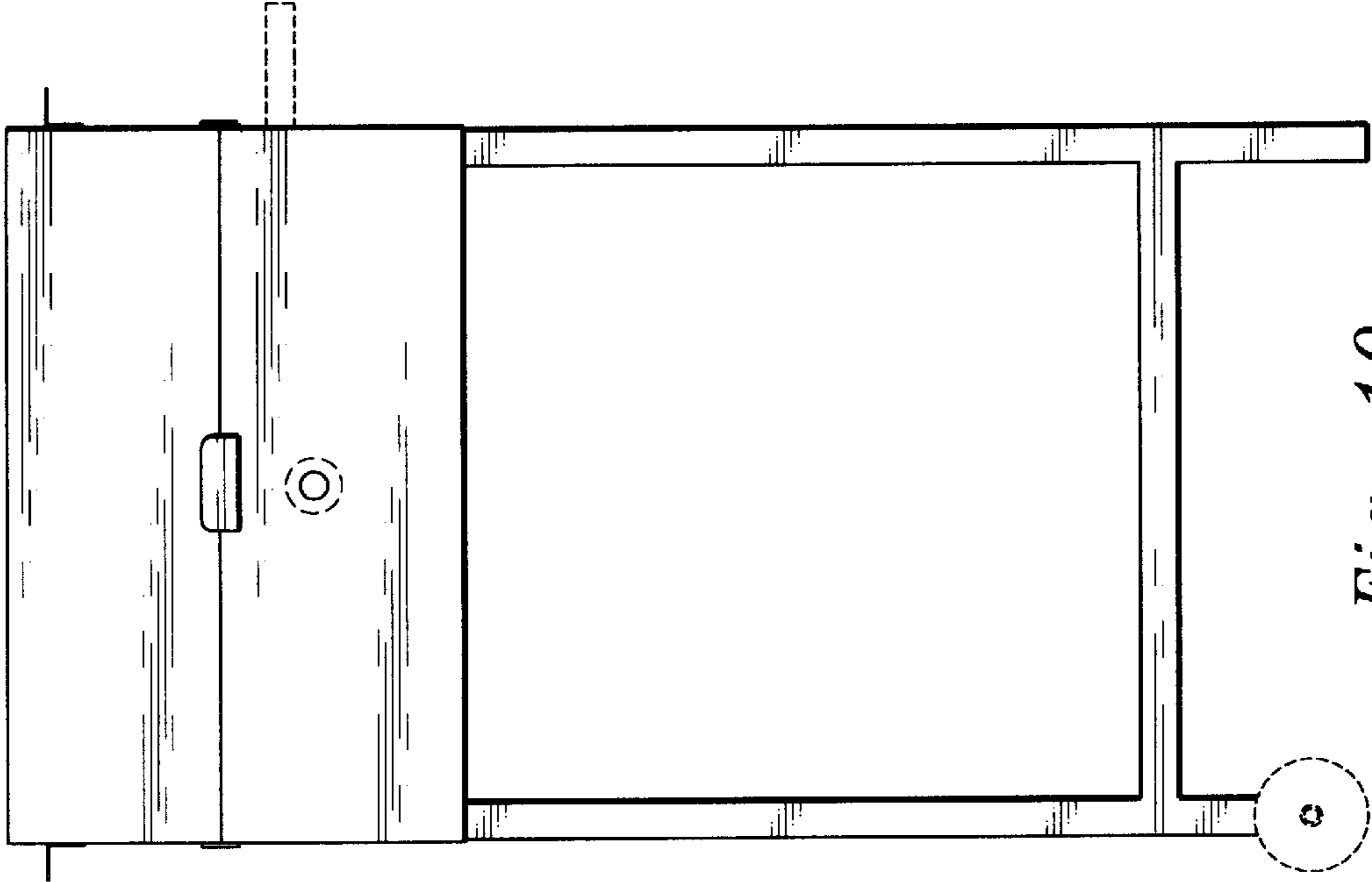

Fig. 10

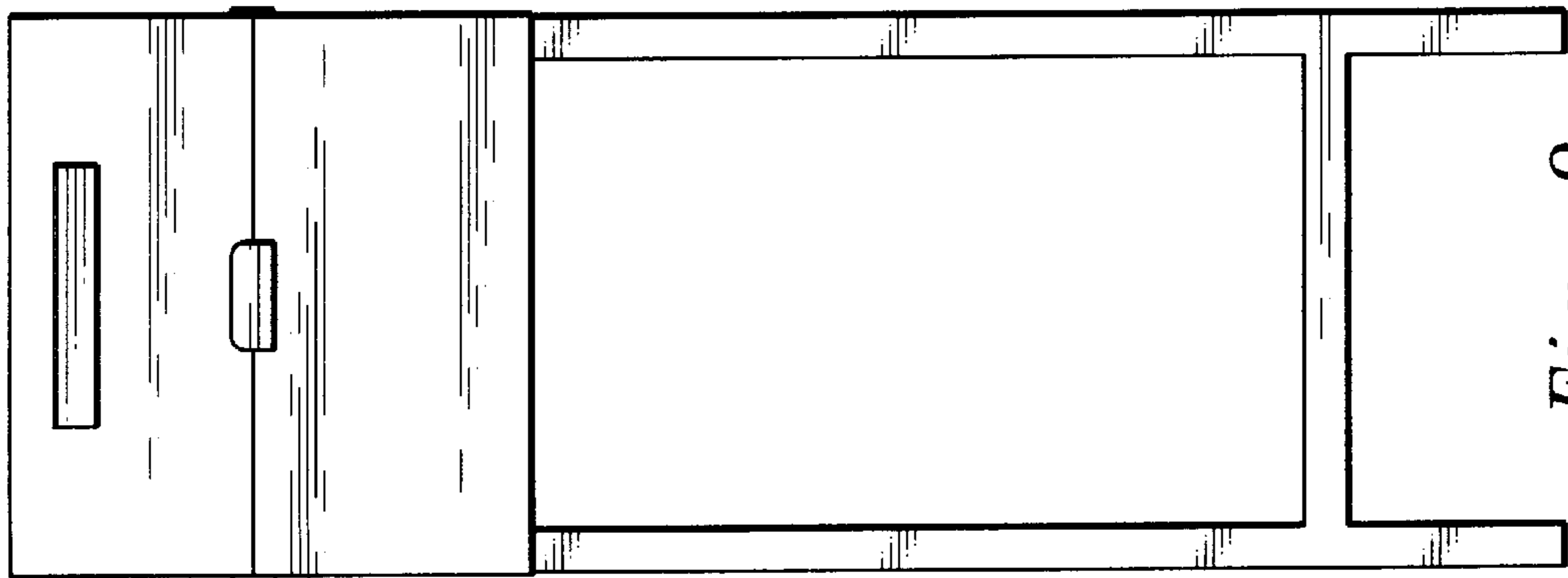

Fig. 9

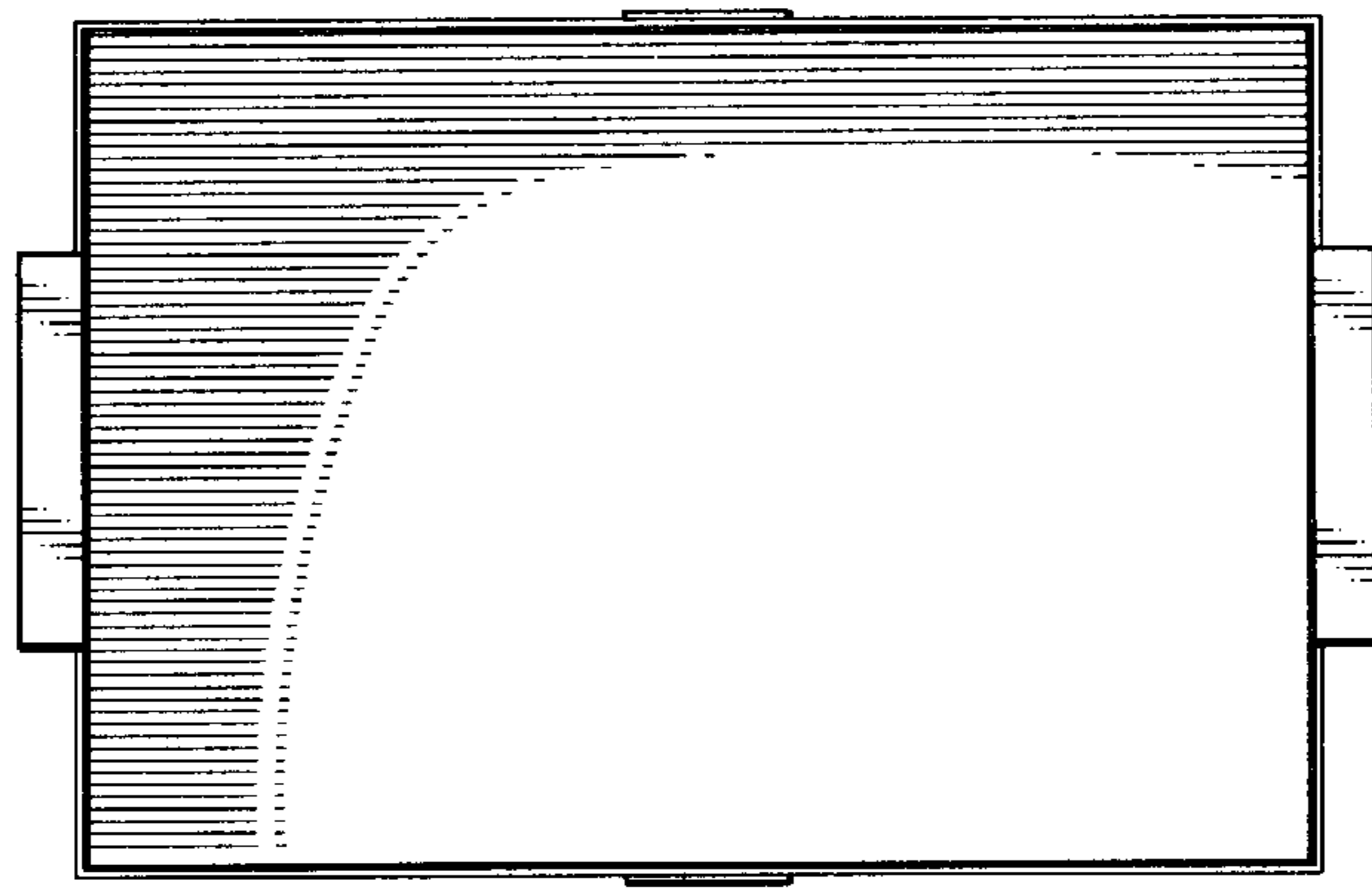

Fig. 14

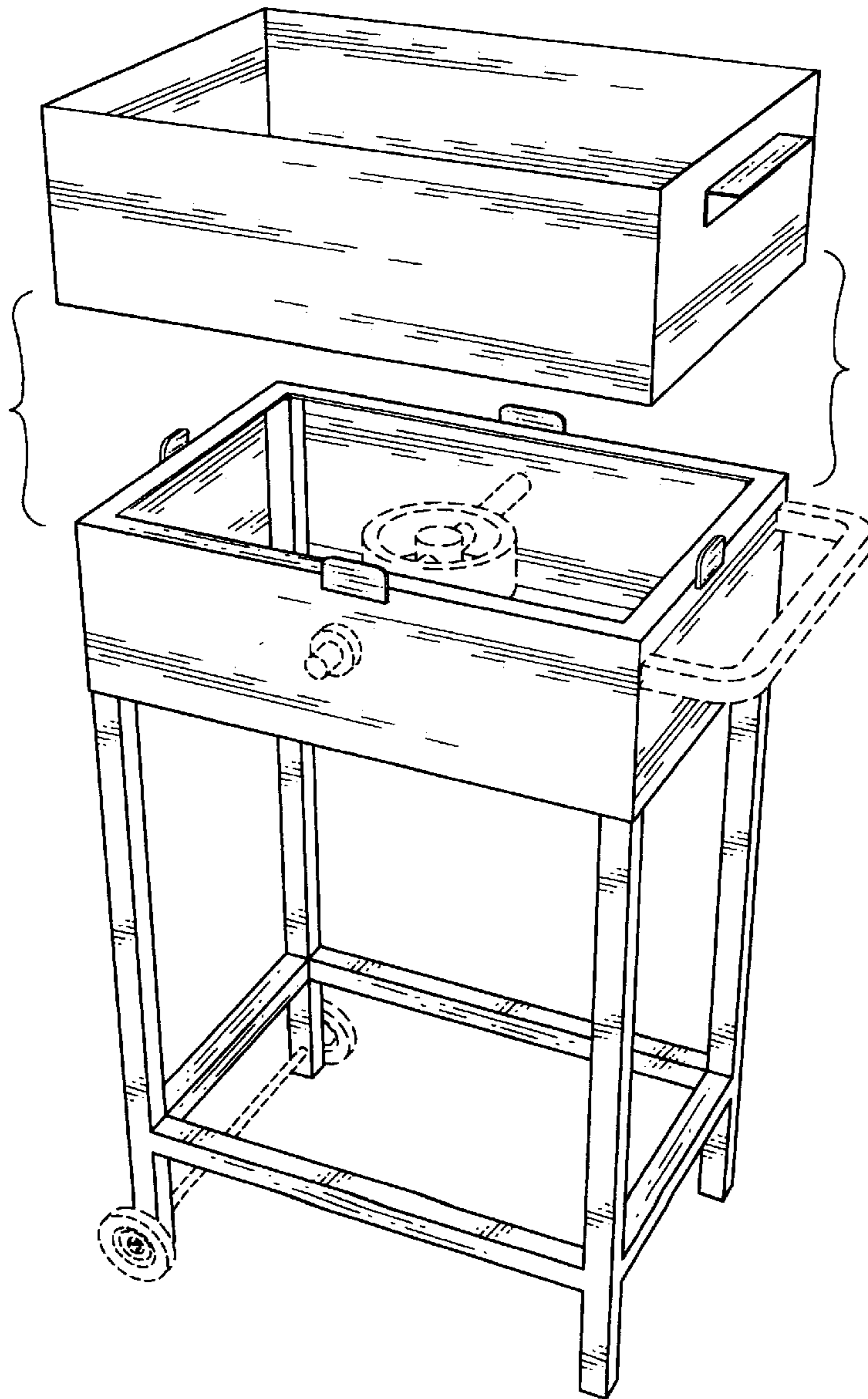

Fig. 13