



US00D401937S

**United States Patent** [19]  
**Isonaga**

[11] **Patent Number: Des. 401,937**

[45] **Date of Patent: \*\*Dec. 1, 1998**

[54] **RADIO RECEIVER**

[75] Inventor: **Yasuaki Isonaga**, Tokyo, Japan

[73] Assignee: **Sony Corporation**, Tokyo, Japan

[\*\*] Term: **14 Years**

[21] Appl. No.: **75,549**

[22] Filed: **Aug. 29, 1997**

[51] **LOC (6) Cl.** ..... **14-03**

[52] **U.S. Cl.** ..... **D14/194; D14/197**

[58] **Field of Search** ..... D14/160-165,  
D14/167-168, 170-171, 188, 192-198;  
455/344, 347, 350, 351

[56] **References Cited**

**U.S. PATENT DOCUMENTS**

D. 264,339	5/1982	Nishimoto et al.	.....	D14/196
D. 267,645	1/1983	Brandsma	.....	D14/196
D. 281,879	12/1985	Ishi et al.	.....	D14/196
D. 369,168	4/1996	Yano	.....	D14/194

**OTHER PUBLICATIONS**

Sony Catalog No. 84, p. 80 (Nov. 1996).

*Primary Examiner*—Ted Shooman  
*Assistant Examiner*—Nanda Bondade

*Attorney, Agent, or Firm*—Foley & Lardner

[57] **CLAIM**

The ornamental design for a radio receiver, as shown and described.

**DESCRIPTION**

FIG. 1 is a perspective view of a first embodiment of a radio receiver showing my new design;

FIG. 2 is a top plan view thereof;

FIG. 3 is a rear elevational view thereof;

FIG. 4 is a left side elevational view thereof;

FIG. 5 is a front elevational view thereof;

FIG. 6 is a bottom plan view thereof;

FIG. 7 is a right side elevational view thereof;

FIG. 8 is a perspective view of a second embodiment of a radio receiver showing my new design;

FIG. 9 is a top plan view thereof;

FIG. 10 is a rear elevational view thereof;

FIG. 11 is a left side elevational view thereof;

FIG. 12 is a front elevational view thereof;

FIG. 13 is a bottom plan view thereof; and,

FIG. 14 is a right side elevational view thereof.

**1 Claim, 6 Drawing Sheets**

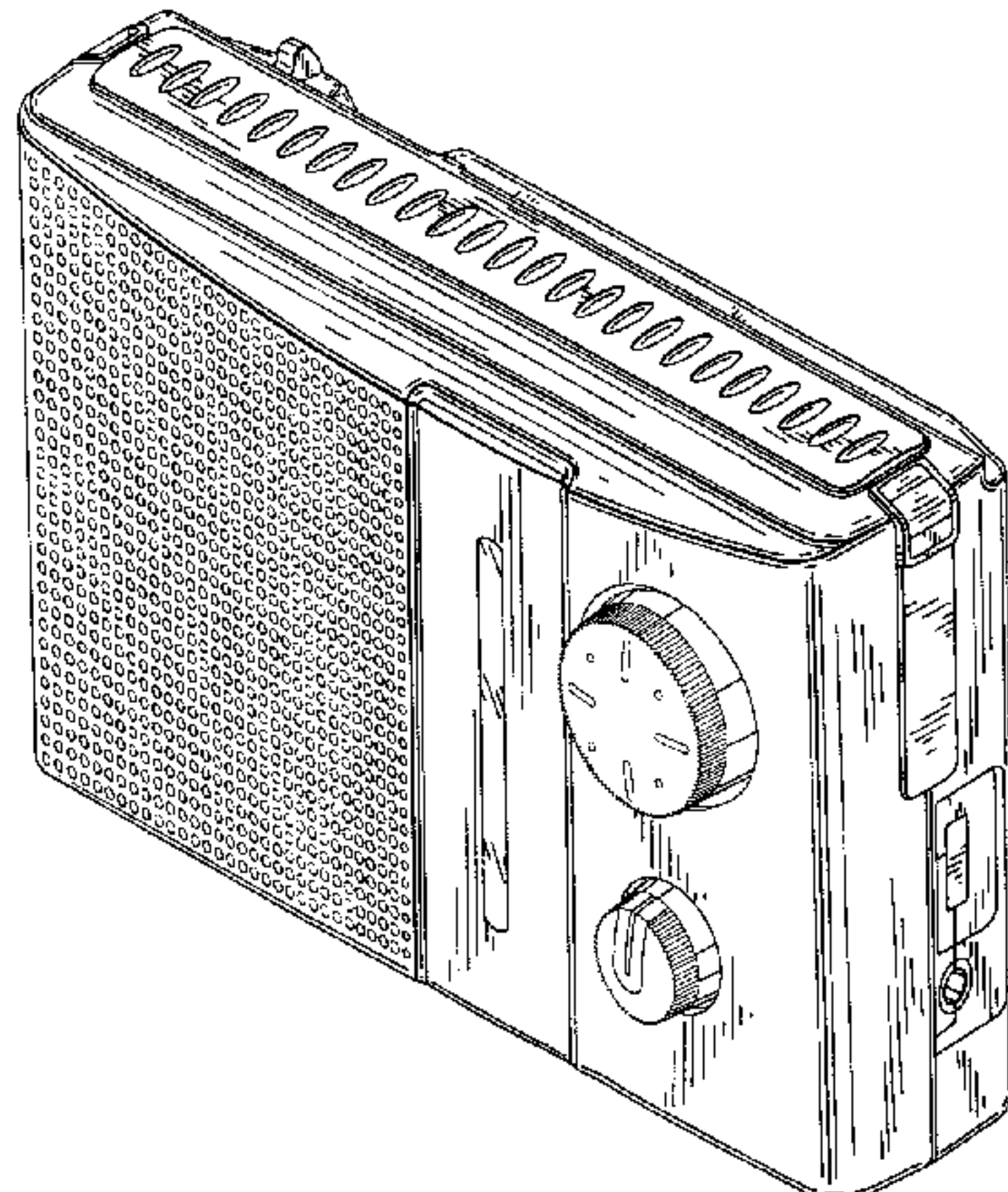
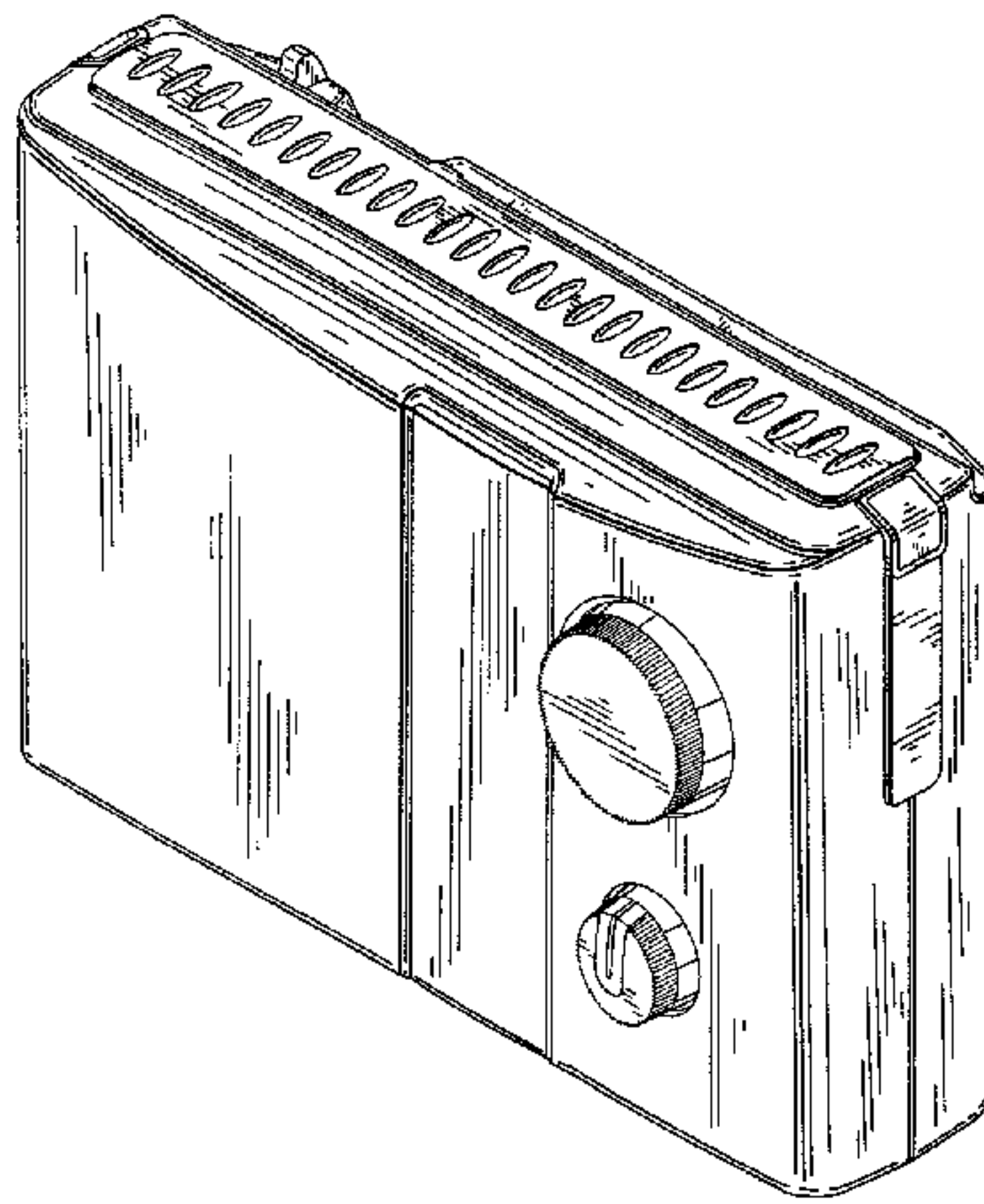

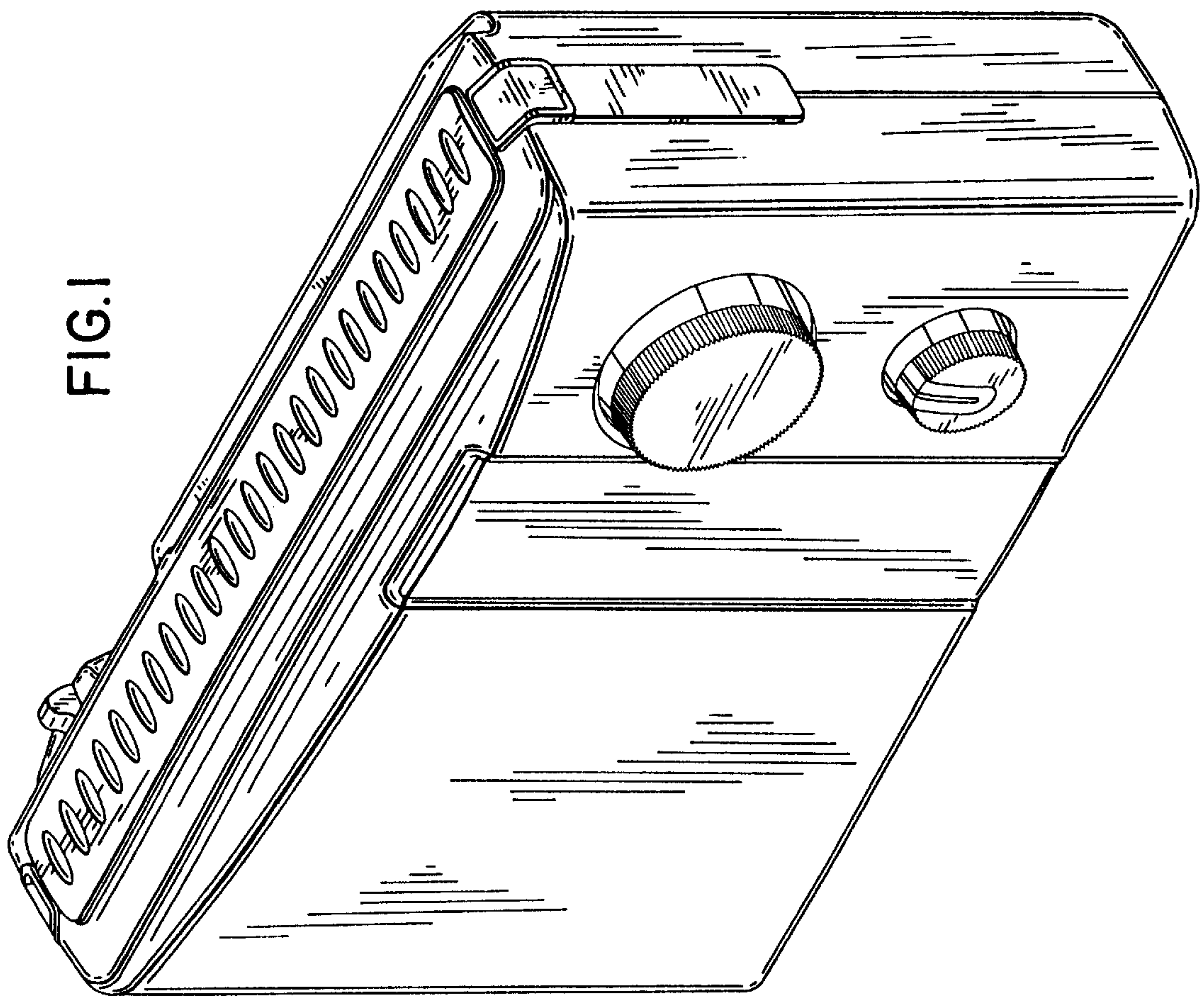

FIG. 1

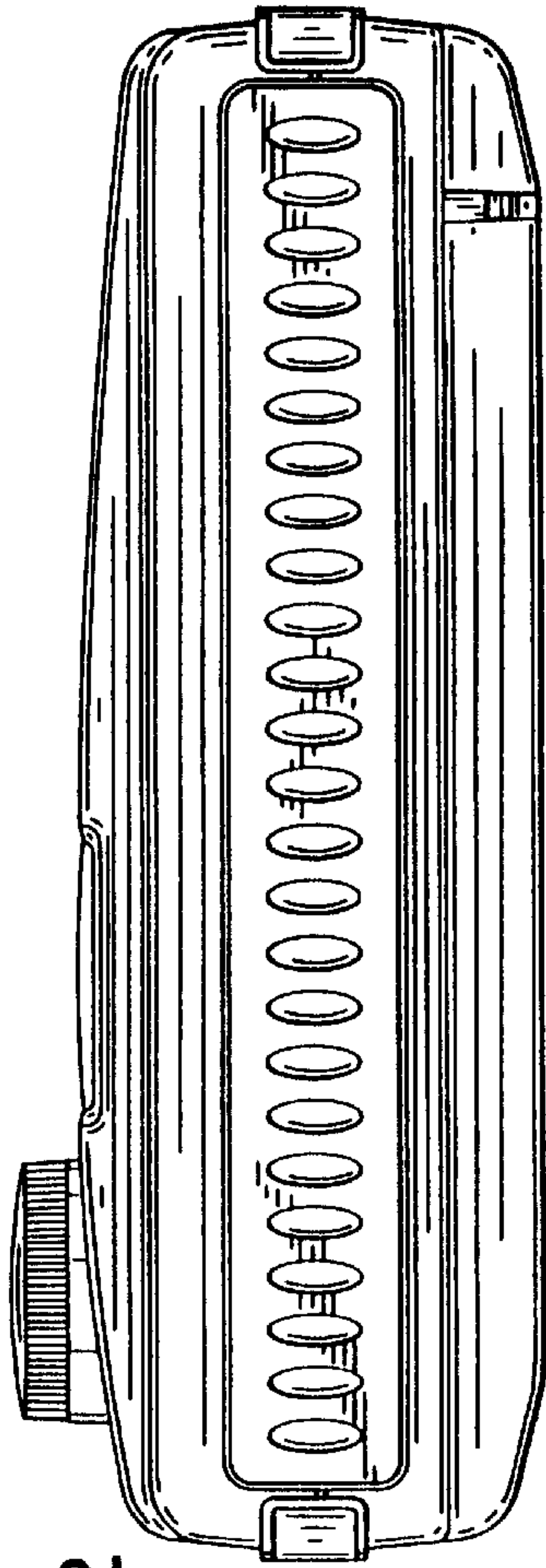

FIG. 2

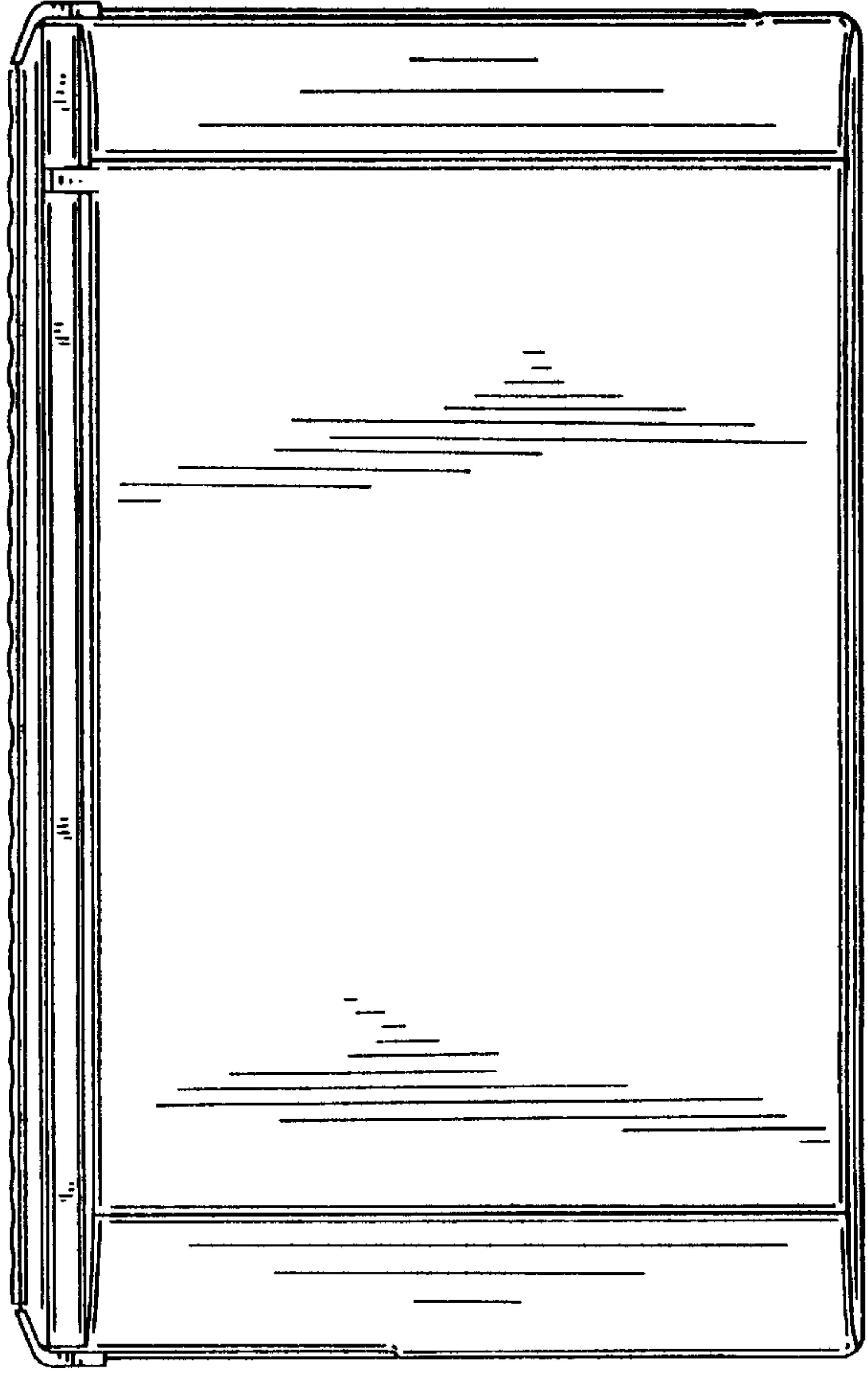
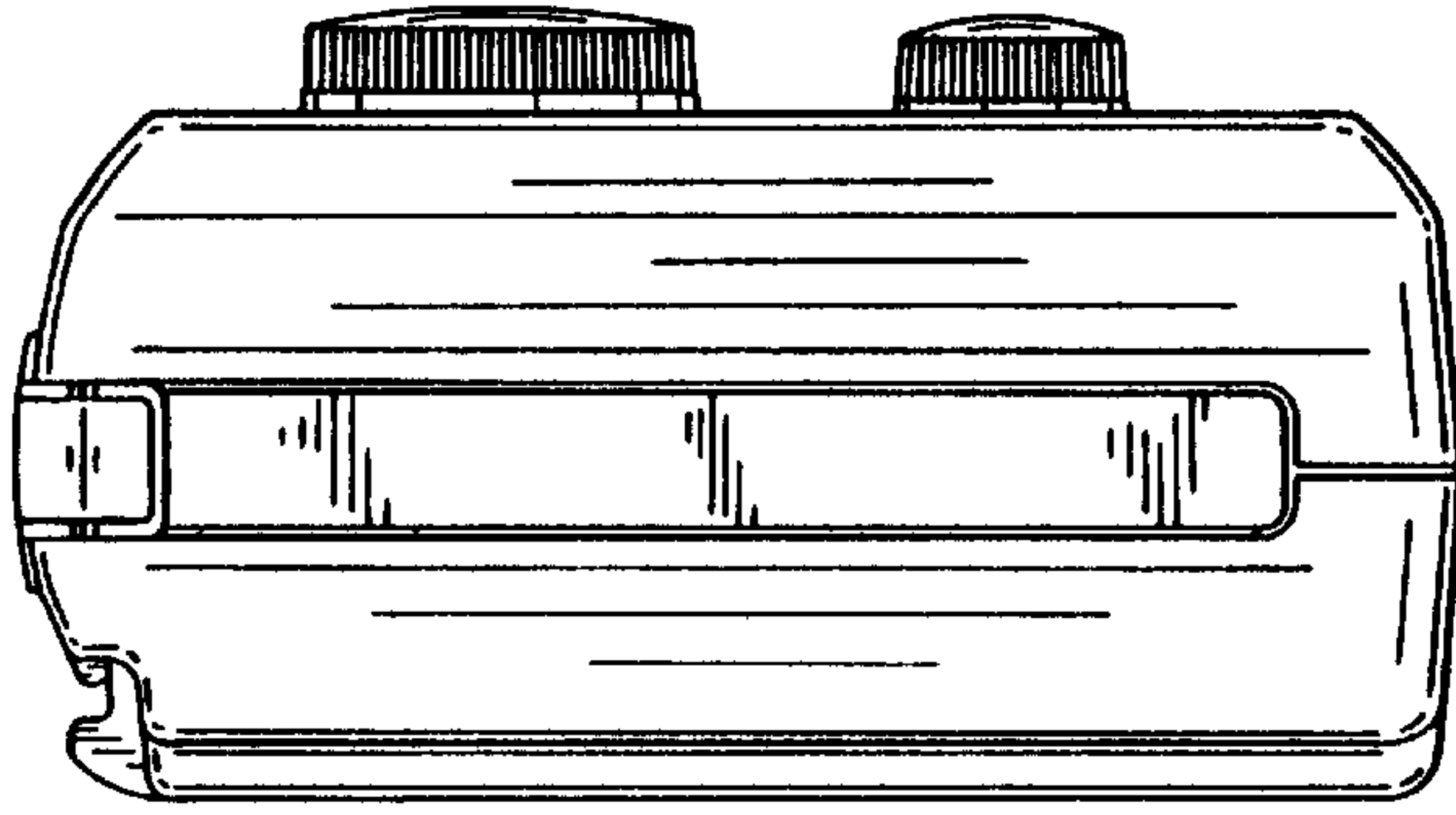

FIG. 3

FIG. 4





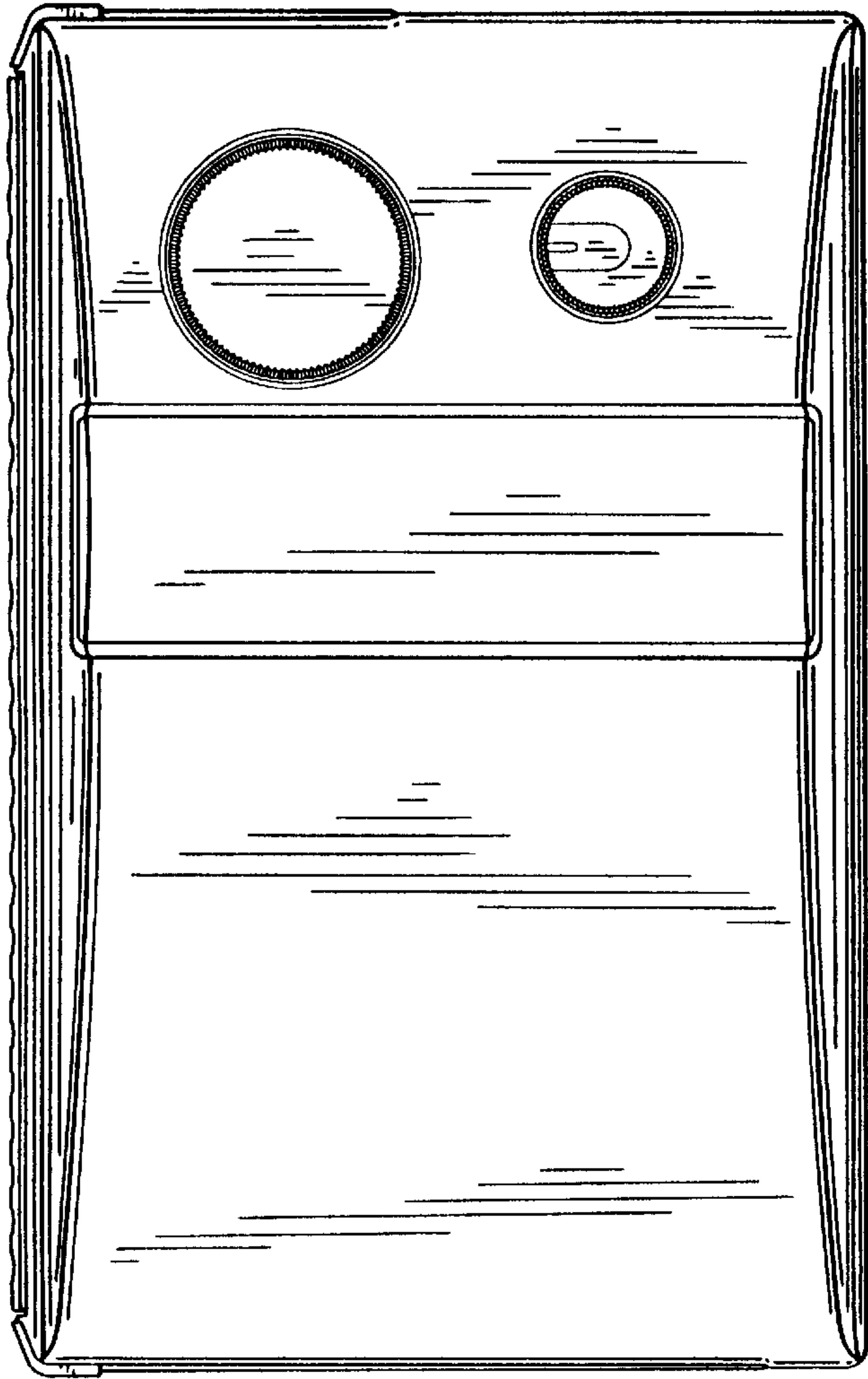

FIG. 5

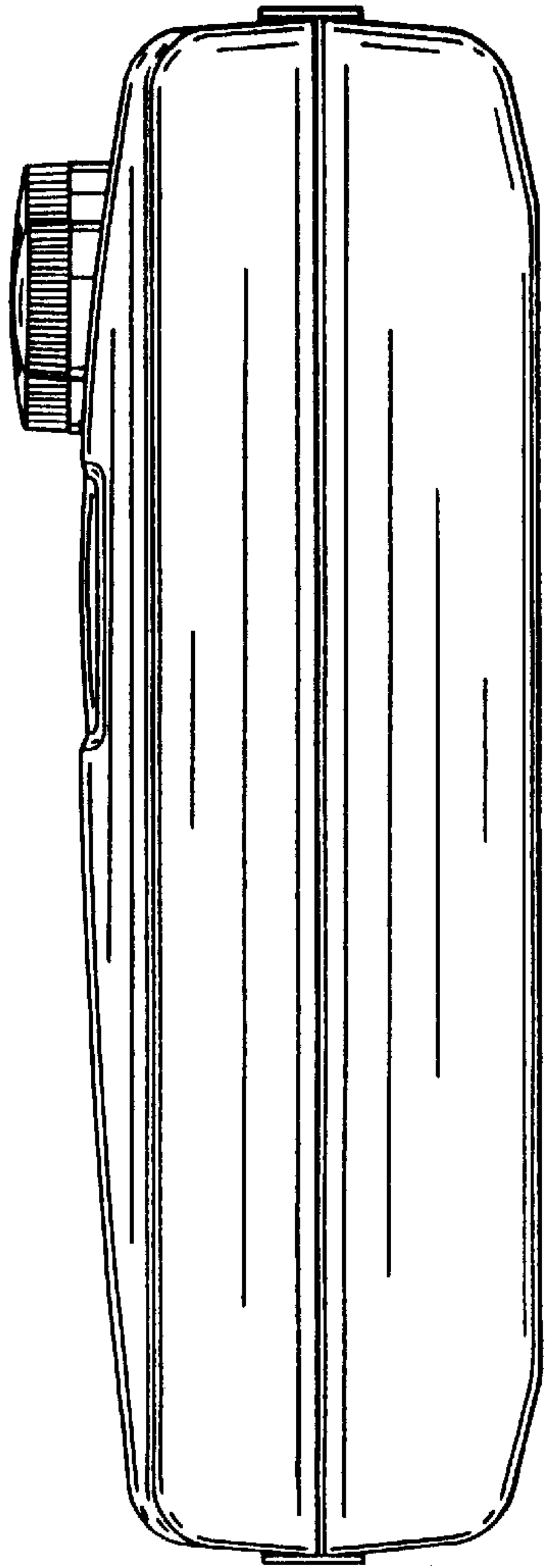

FIG. 6

FIG. 7

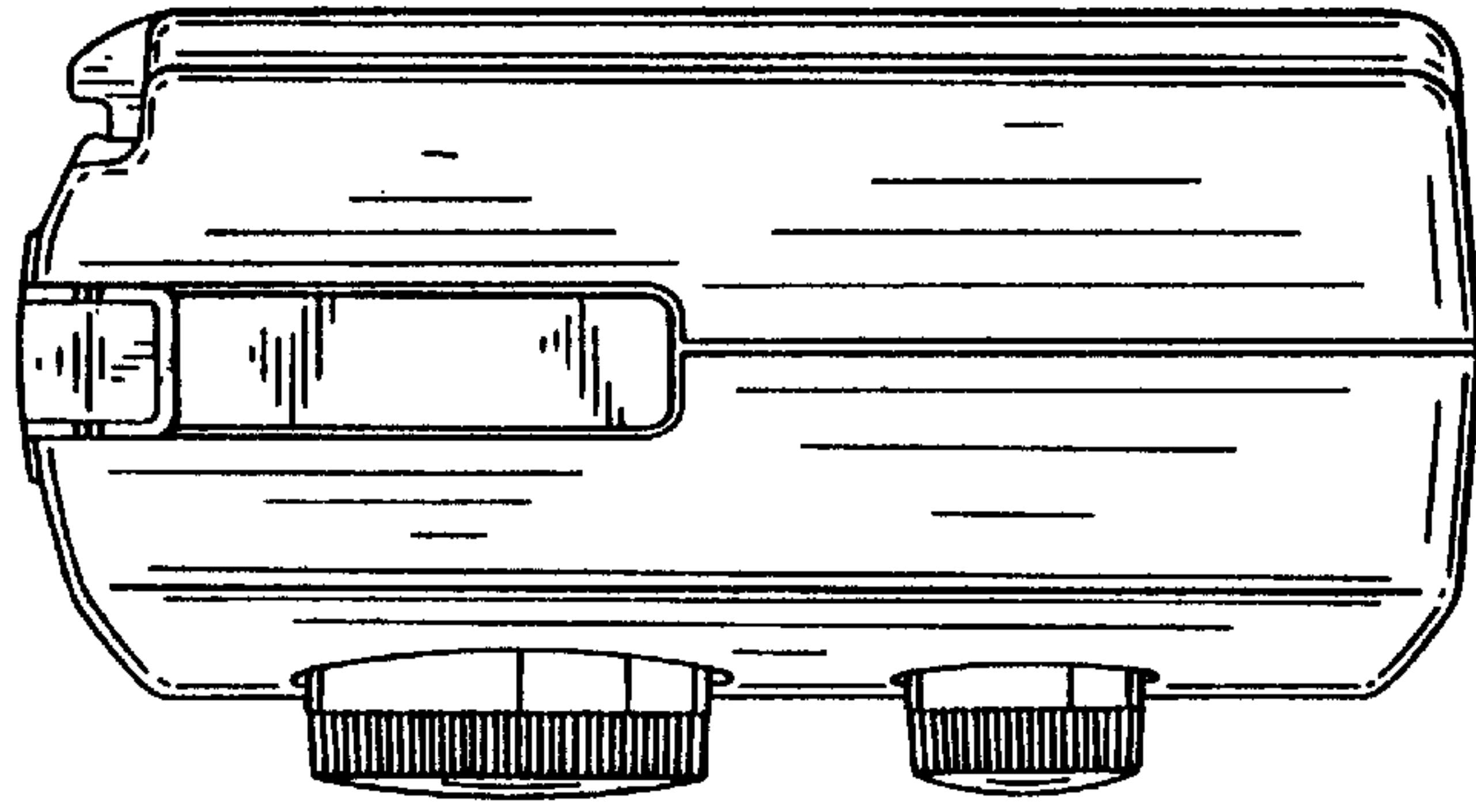
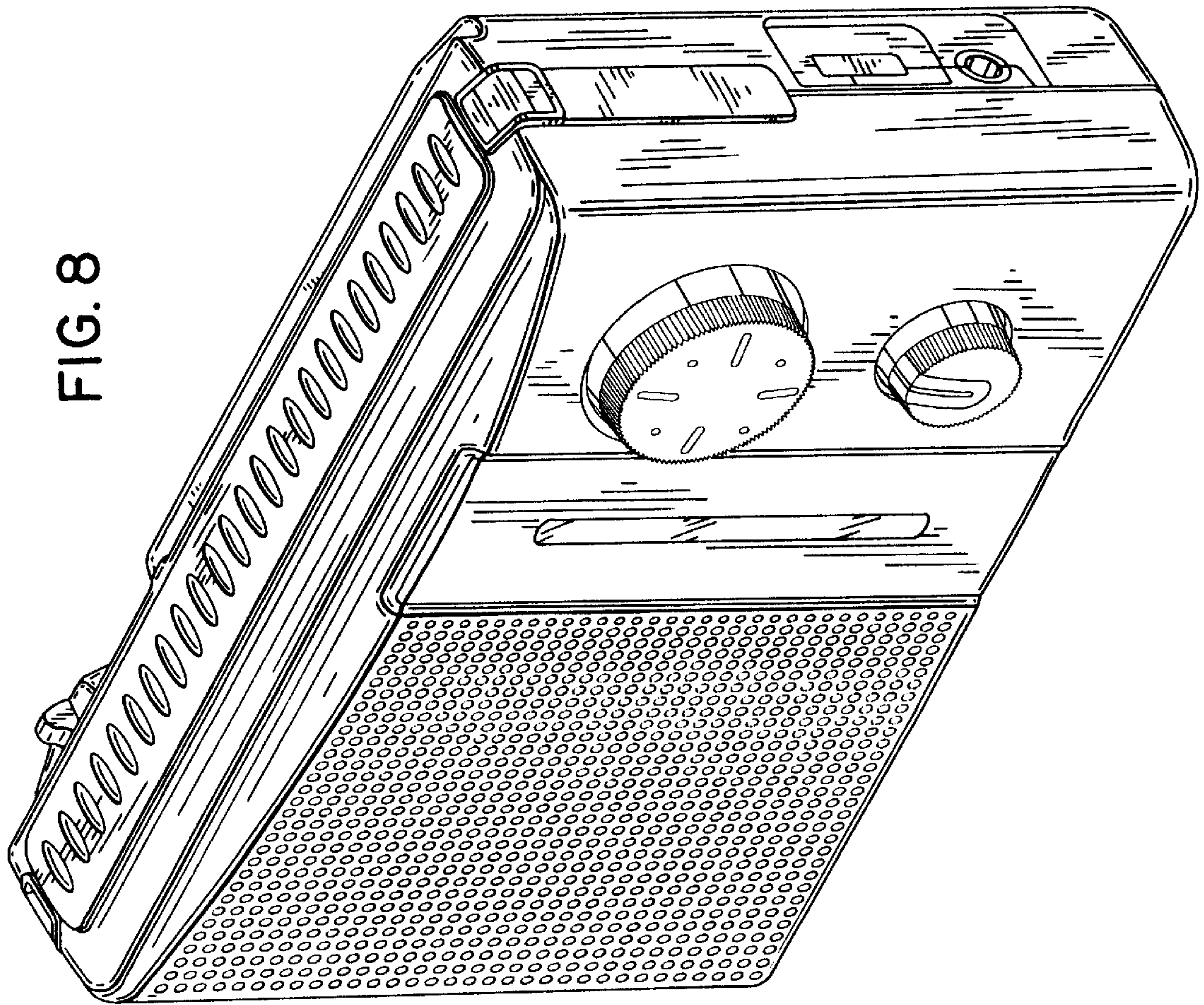

FIG. 8



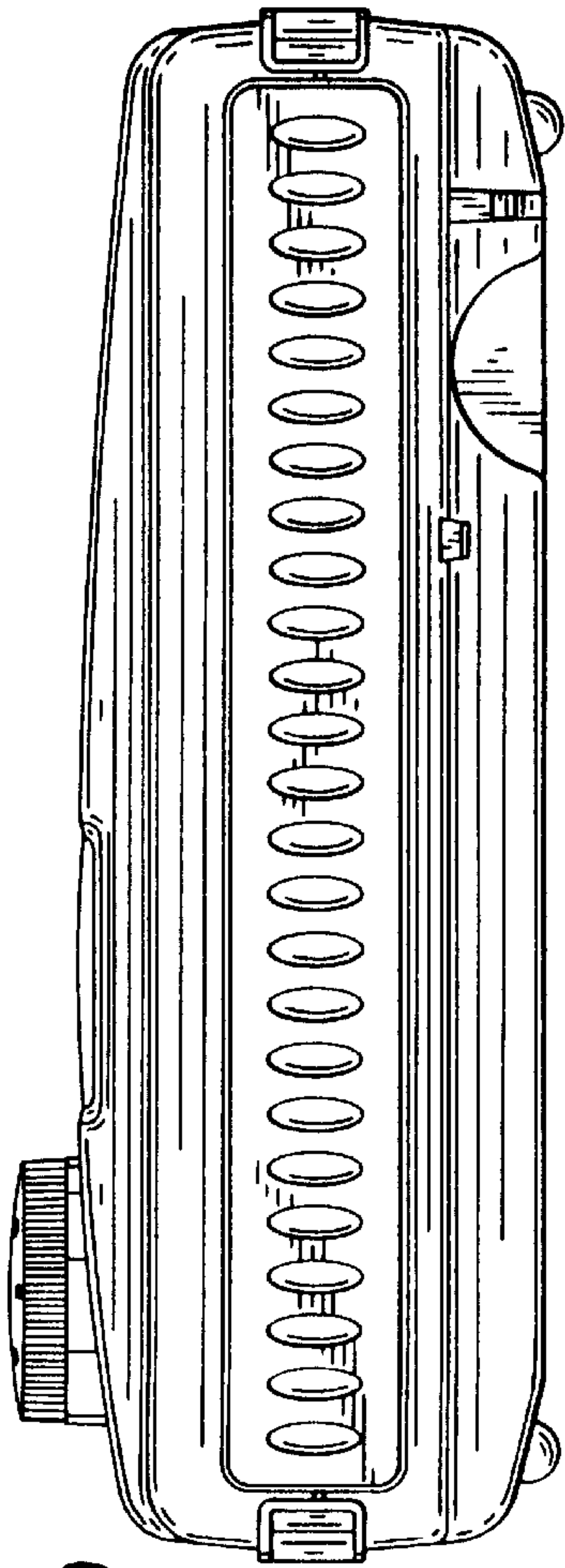

FIG. 9

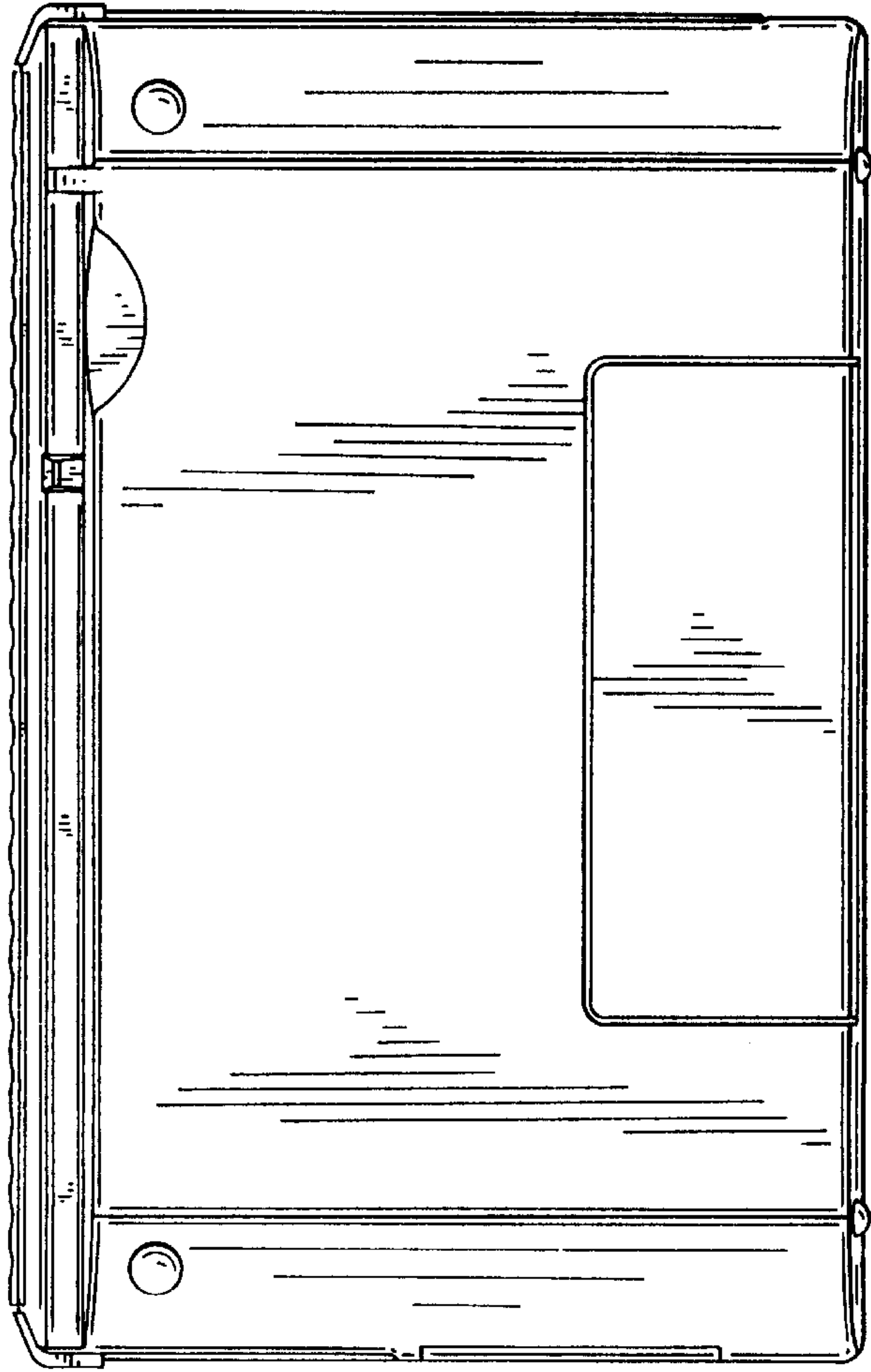

FIG. 10

FIG. 11

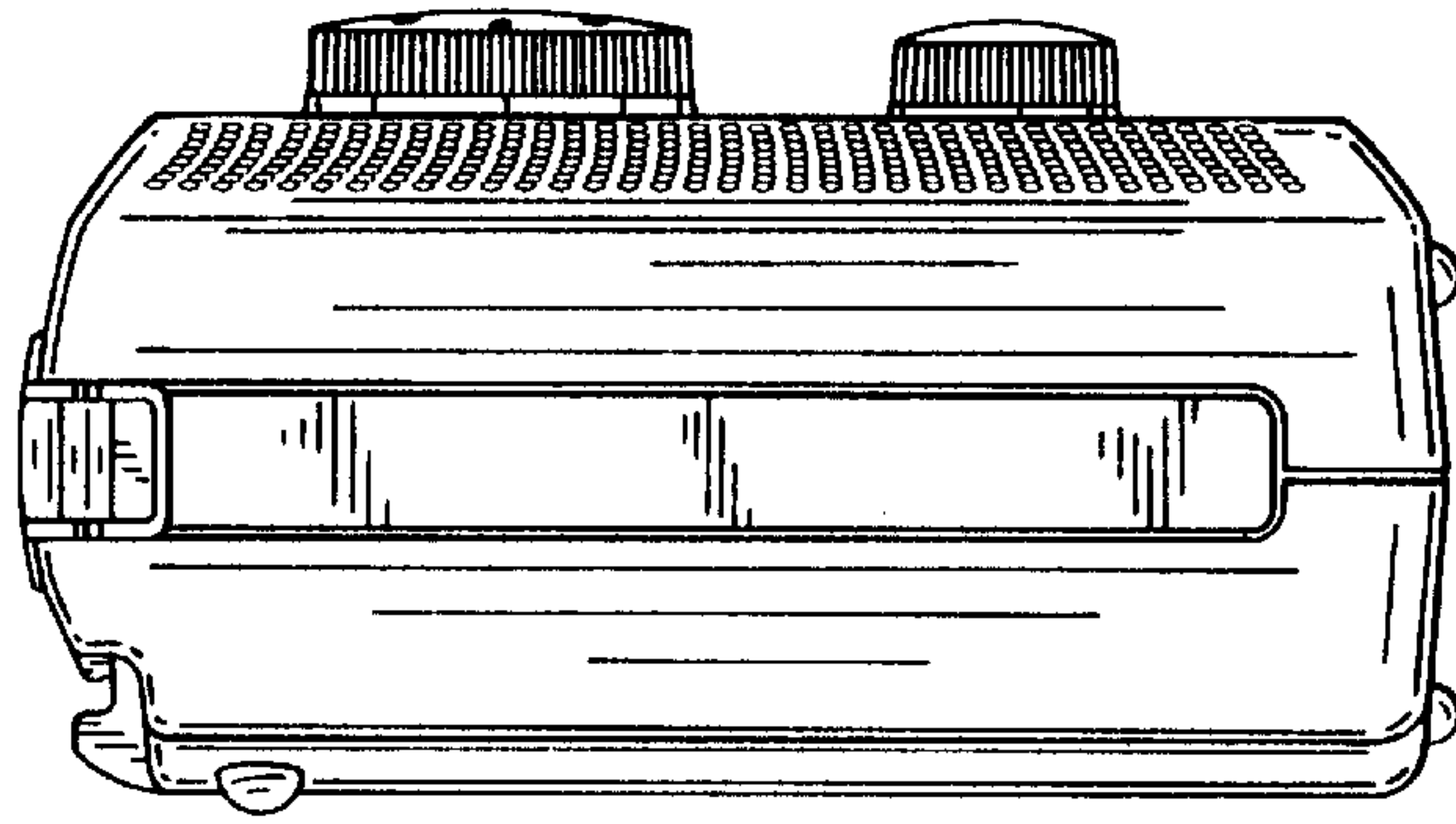



FIG.14

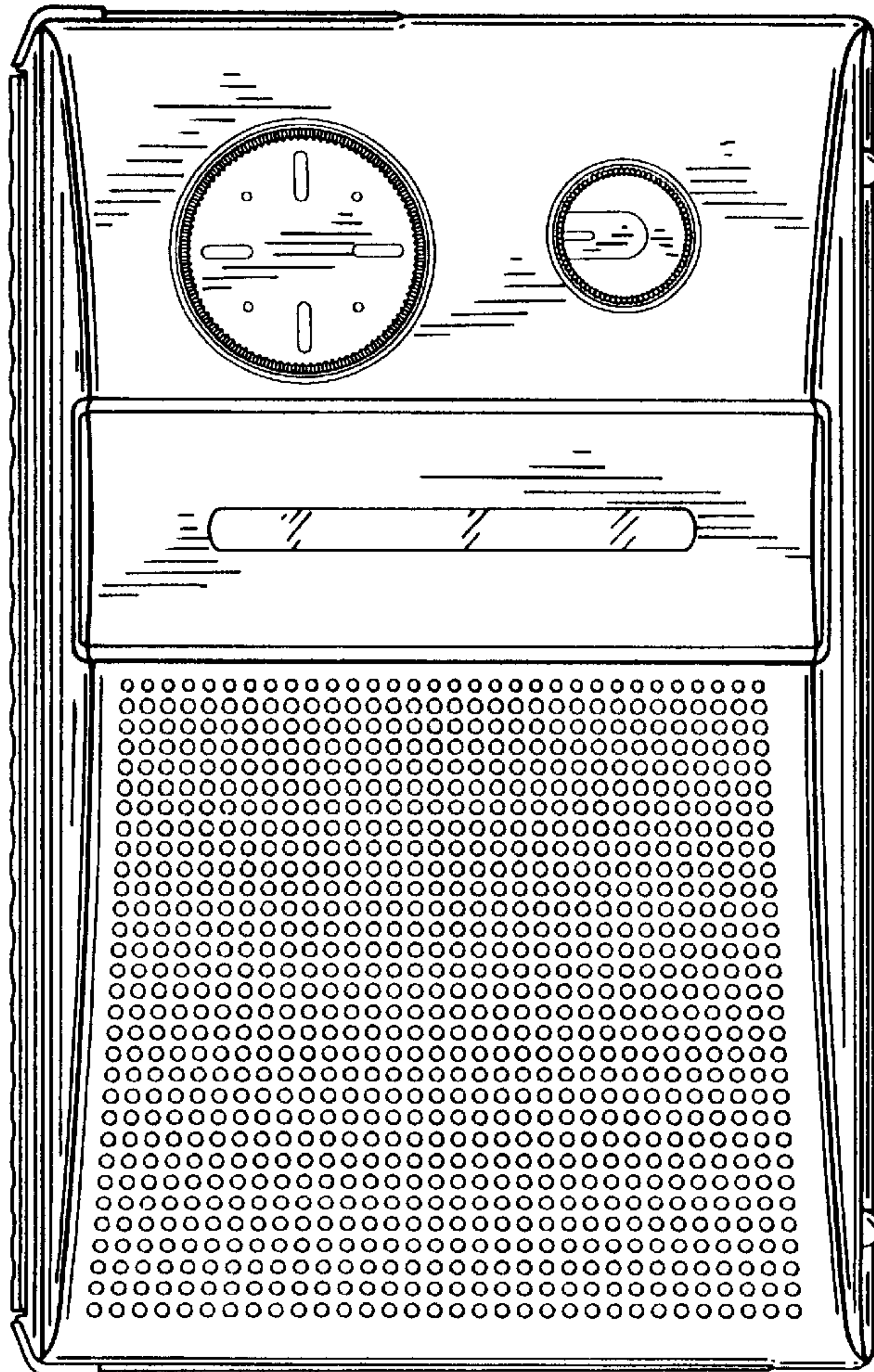
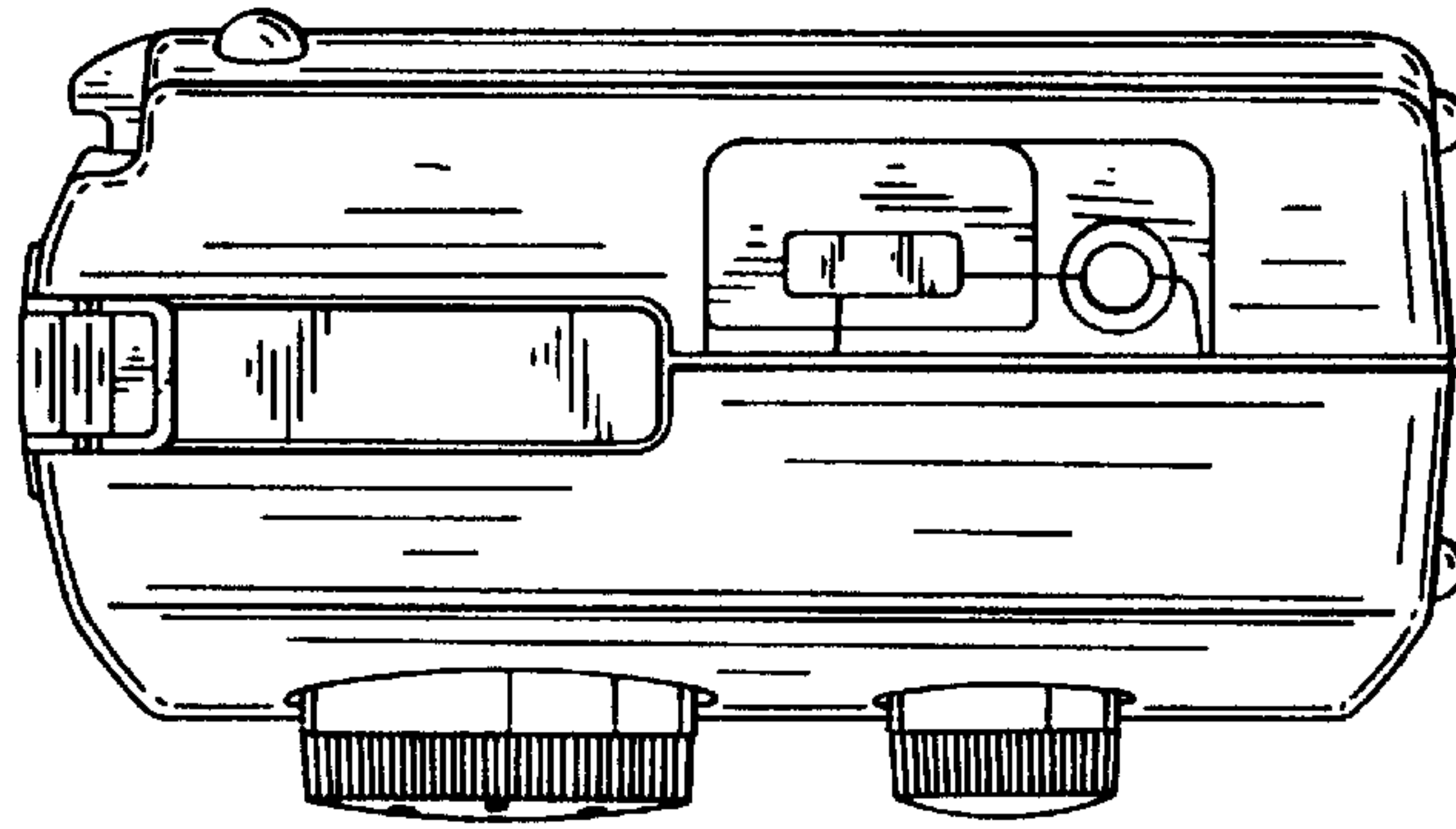

FIG.12

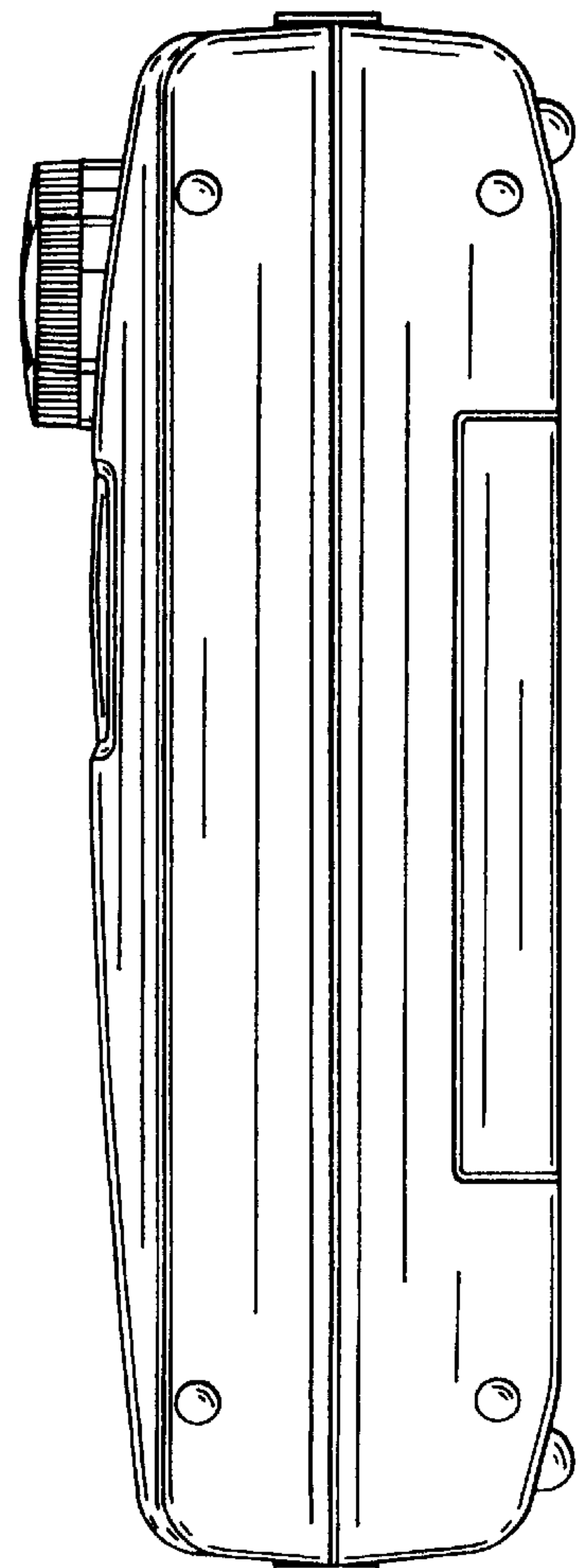

FIG.13