



US00D401858S

**United States Patent** [19]  
**Zebrowski**

[11] **Patent Number: Des. 401,858**  
[45] **Date of Patent: \*\*Dec. 1, 1998**

[54] **BOTTLE**

[76] Inventor: **Stanton Zebrowski**, 61-73 Seaview Ave., Stamford, Conn. 06902

[\*\*] Term: **14 Years**

[21] Appl. No.: **48,913**

[22] Filed: **Jan. 16, 1996**

[51] **LOC (6) Cl. .... 09-01**

[52] **U.S. Cl. .... D9/531**

[58] **Field of Search .... D9/531, 500, 503; 215/385, 396, 398**

[56] **References Cited**

**U.S. PATENT DOCUMENTS**

D. 204,500	4/1966	Gould .....	D9/531
D. 227,654	7/1973	Byrne .....	D9/531
D. 271,377	11/1983	Klim .....	D9/531
5,322,184	6/1994	Bergner et al. ....	215/383 X
5,398,828	3/1995	Valyi .....	215/396

**OTHER PUBLICATIONS**

Packaging Review, Nov. 1980, cover, PET bottles.

*Primary Examiner*—Lucy Lieberman  
*Attorney, Agent, or Firm*—Patrick J. Walsh

[57] **CLAIM**

The ornamental designs for a bottle, as shown and described.

**DESCRIPTION**

FIG. 1 is a front elevation view of a bottle showing my new design;

FIG. 2 is a right side elevation of the bottle with the handle area shown in cross section;

FIG. 3 is a right side elevation of the bottle, the left side elevation is a mirror image thereto;

FIG. 4 is a sectional view taken along line 4—4 in FIG. 3;

FIG. 5 is a front elevation view of a bottle showing a modified embodiment of my new design; and,

FIG. 6 is a right side elevation of the second embodiment, the left side is a mirror image thereto.

The portions of the top and bottom of both embodiments the are not shown in the drawings do not form part of the claimed design.

**1 Claim, 5 Drawing Sheets**

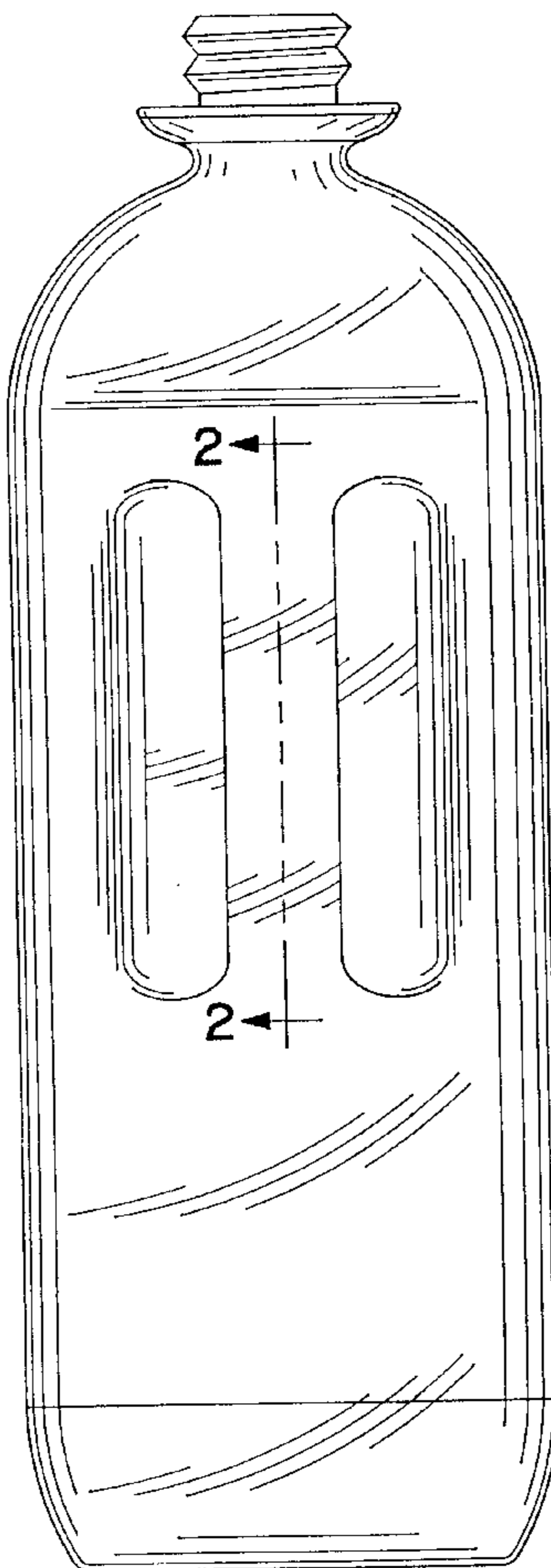

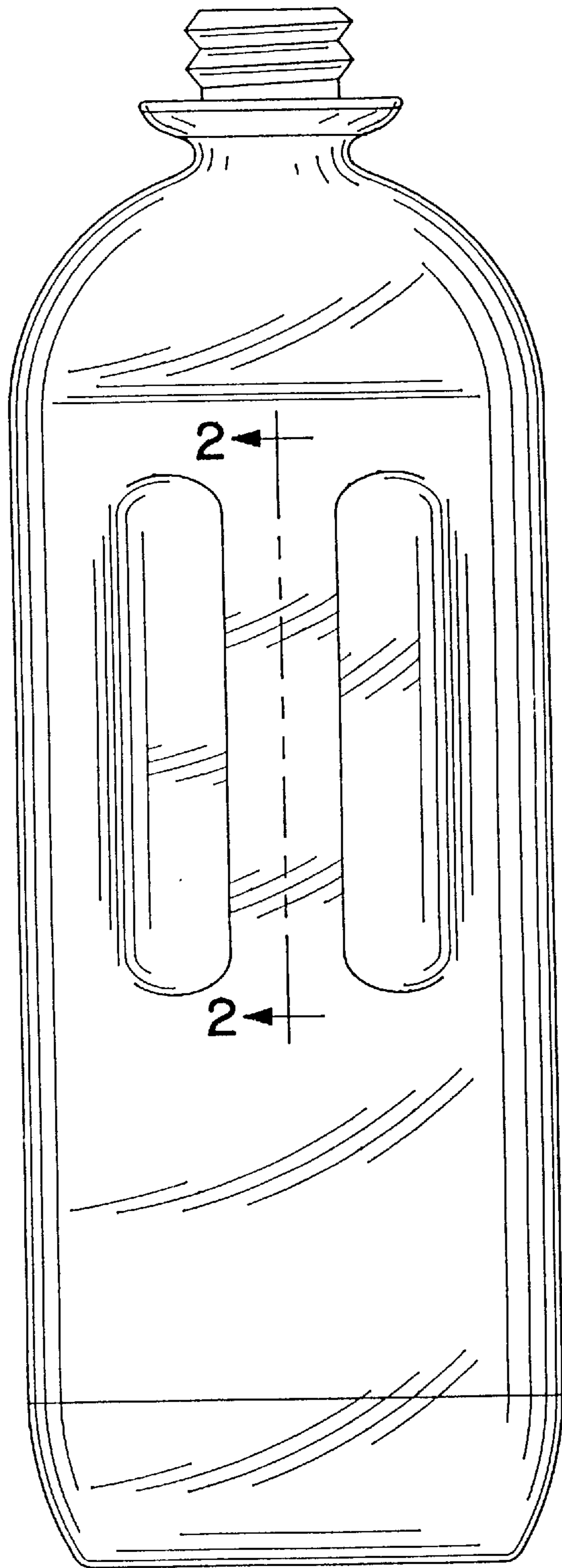

FIG. 1

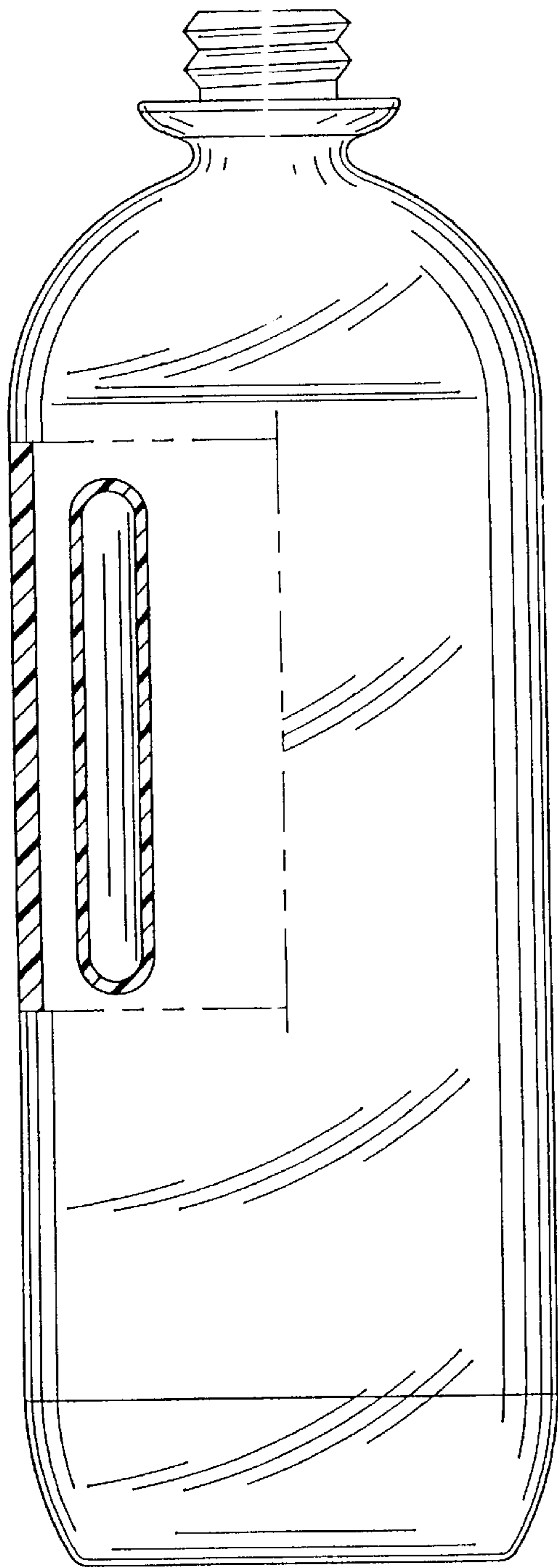

FIG. 2

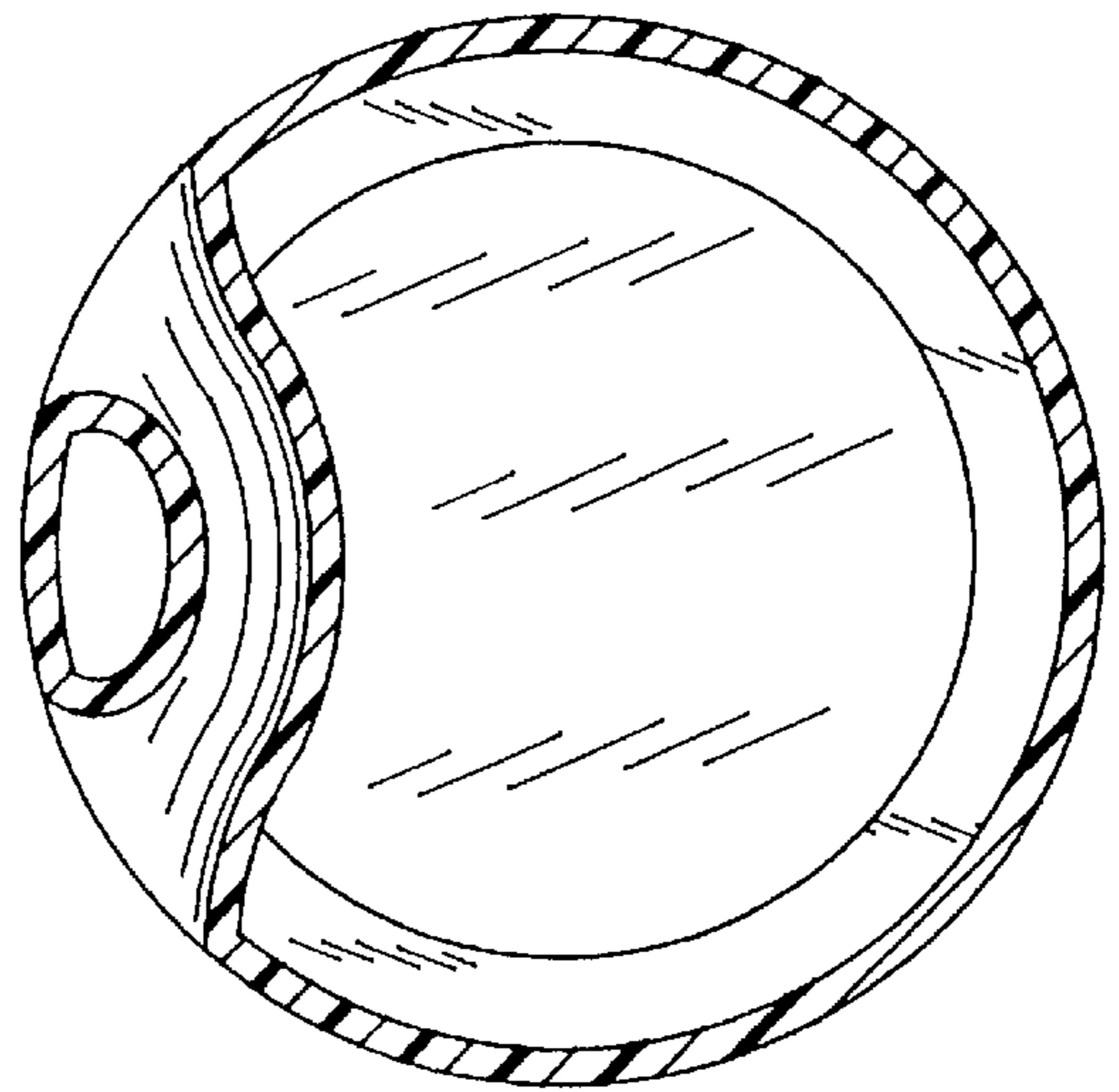

FIG. 4

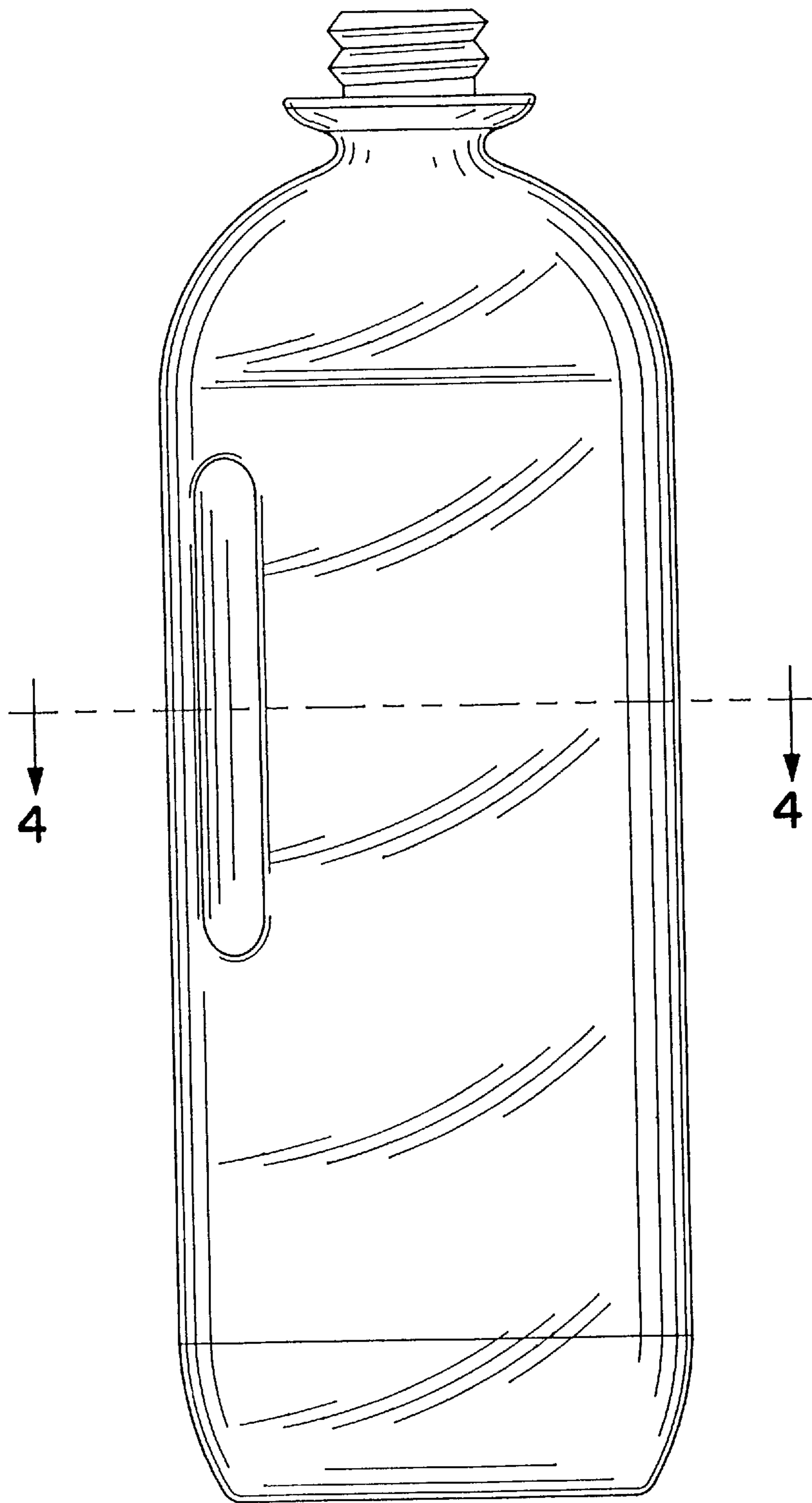

FIG. 3

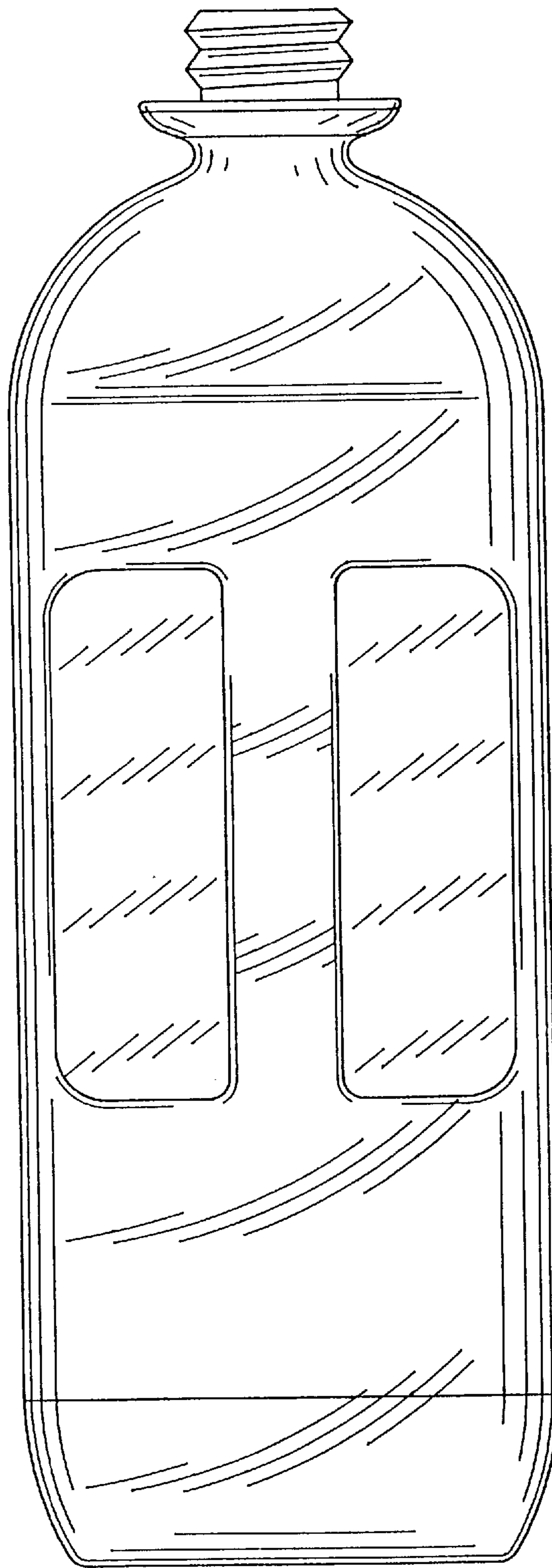

FIG. 5

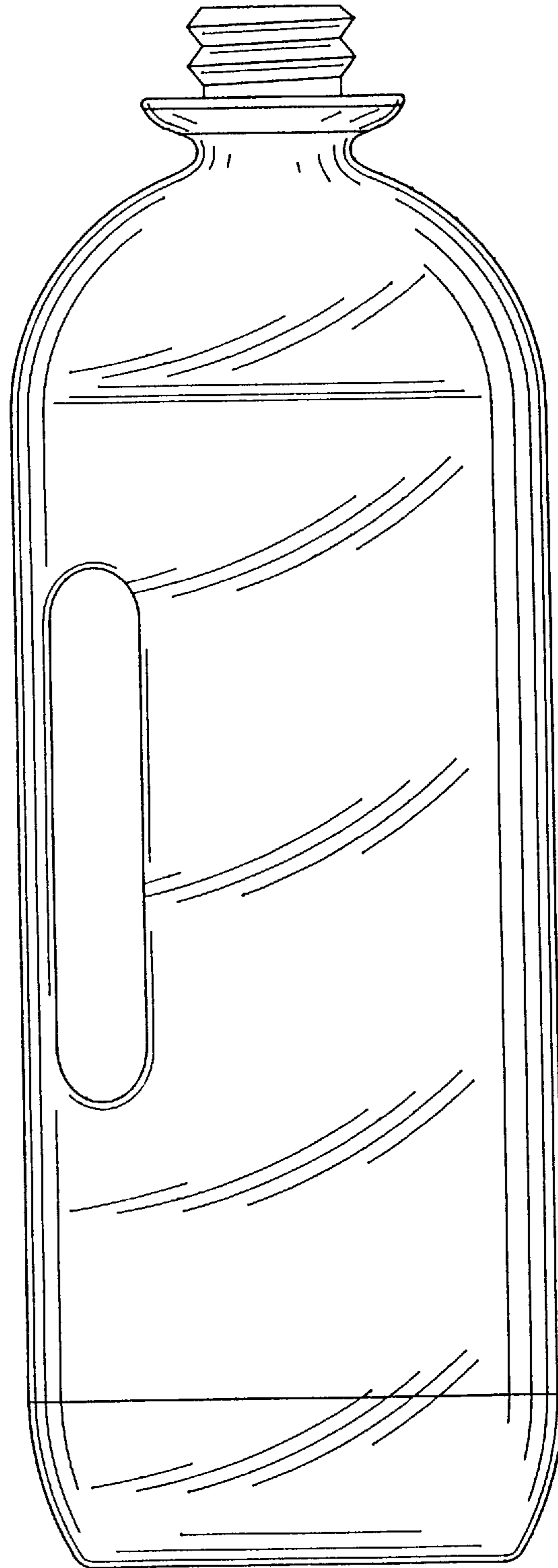

FIG. 6