



US00D401850S

United States Patent [19] Srinaul

[11] **Patent Number: Des. 401,850**

[45] **Date of Patent: **Dec. 1, 1998**

[54] **JEWELRY BOX HAVING CUT CORNERS**

4,461,383 7/1984 Groff 206/566 X
4,732,269 3/1988 Roy 206/6.1 X
5,547,072 8/1996 Kaiser 206/6.1 X

[75] Inventor: **Sanaie Srinaul**, Bangpong, Thailand

[73] Assignee: **Cosmo Group PCL**, Bangkok, Thailand

[**] Term: **14 Years**

[21] Appl. No.: **72,487**

[22] Filed: **Jun. 17, 1997**

[51] **LOC (6) Cl. 09-07**

[52] **U.S. Cl. D9/423; D9/432**

[58] **Field of Search D9/423, 424, 430, D9/432, 337; 206/566, 594, 524.3, 301, 18, 6.1, 45.24, 45.2, 736, 751; 220/337, 339, 375, 376; 224/903**

[56] **References Cited**

U.S. PATENT DOCUMENTS

| | | | |
|------------|--------|-----------------|-----------|
| D. 333,264 | 2/1993 | Kaplan . | |
| D. 344,676 | 3/1994 | Newman | D9/423 X |
| D. 381,198 | 7/1997 | Just | D3/903 X |
| 1,636,251 | 7/1927 | Shields | 206/6.1 X |
| 4,043,450 | 8/1977 | Rielly | 206/566 X |
| 4,101,023 | 7/1978 | Schuander | 206/566 X |

OTHER PUBLICATIONS

Jeweler's Circular Keystone, p. 59, Jun. 1978.

Primary Examiner—Prabhakar G. Deshmukh
Attorney, Agent, or Firm—Leighton K. Chong

[57] **CLAIM**

The ornamental design for jewelry box having cut corners, as shown and described.

DESCRIPTION

FIG. 1 is a front perspective view of a jewelry box having cut corners showing my new design;
FIG. 2 is a front perspective view thereof; in an open position;
FIG. 3 is a top plan view of FIG. 1;
FIG. 4 is a bottom plan view of FIG. 1;
FIG. 5 is a front elevational view of FIG. 1;
FIG. 6 is a rear elevational view of FIG. 1;
FIG. 7 is a left side elevational view of FIG. 1; and,
FIG. 8 is a right side elevational view of FIG. 1.

1 Claim, 2 Drawing Sheets

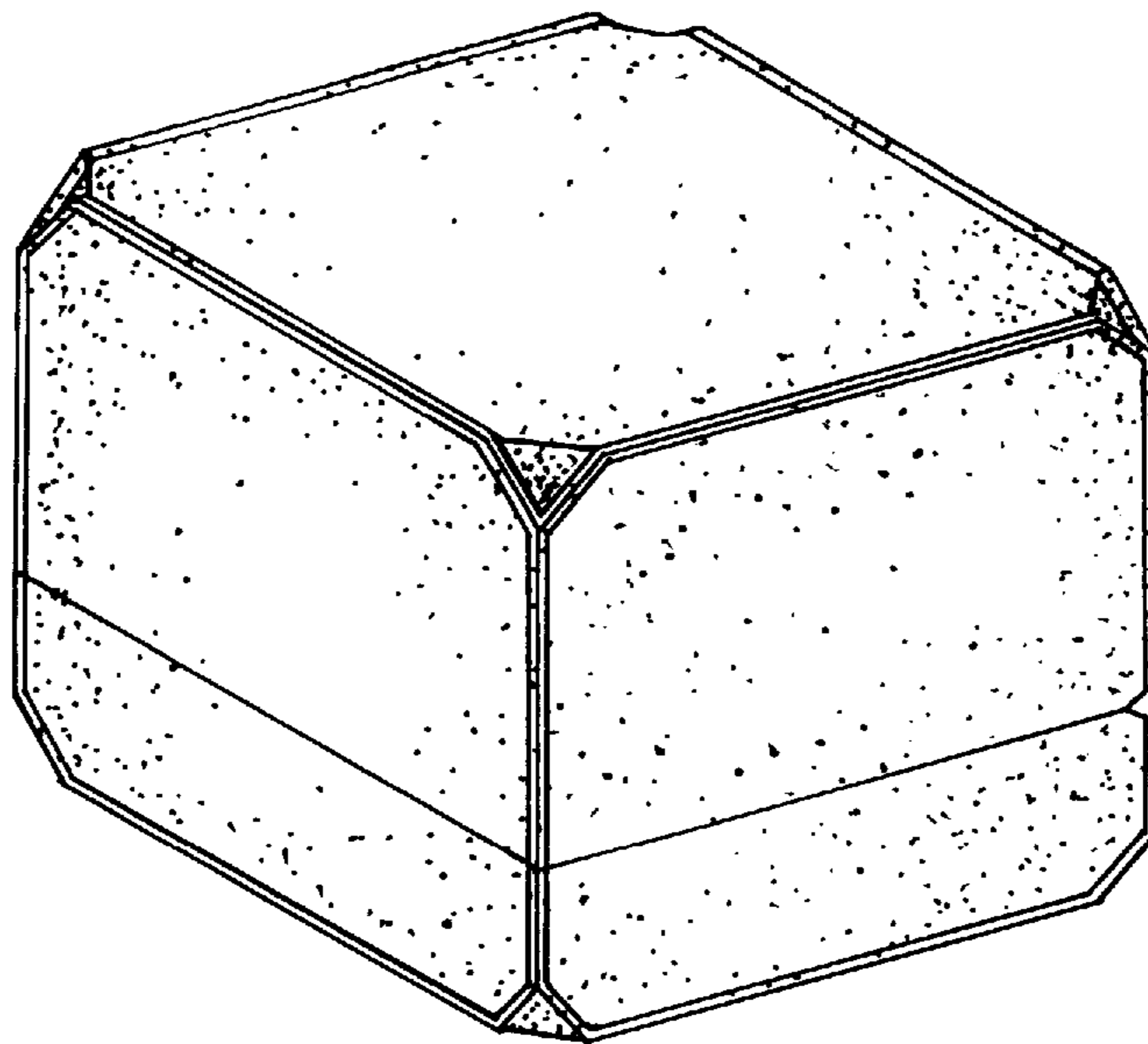

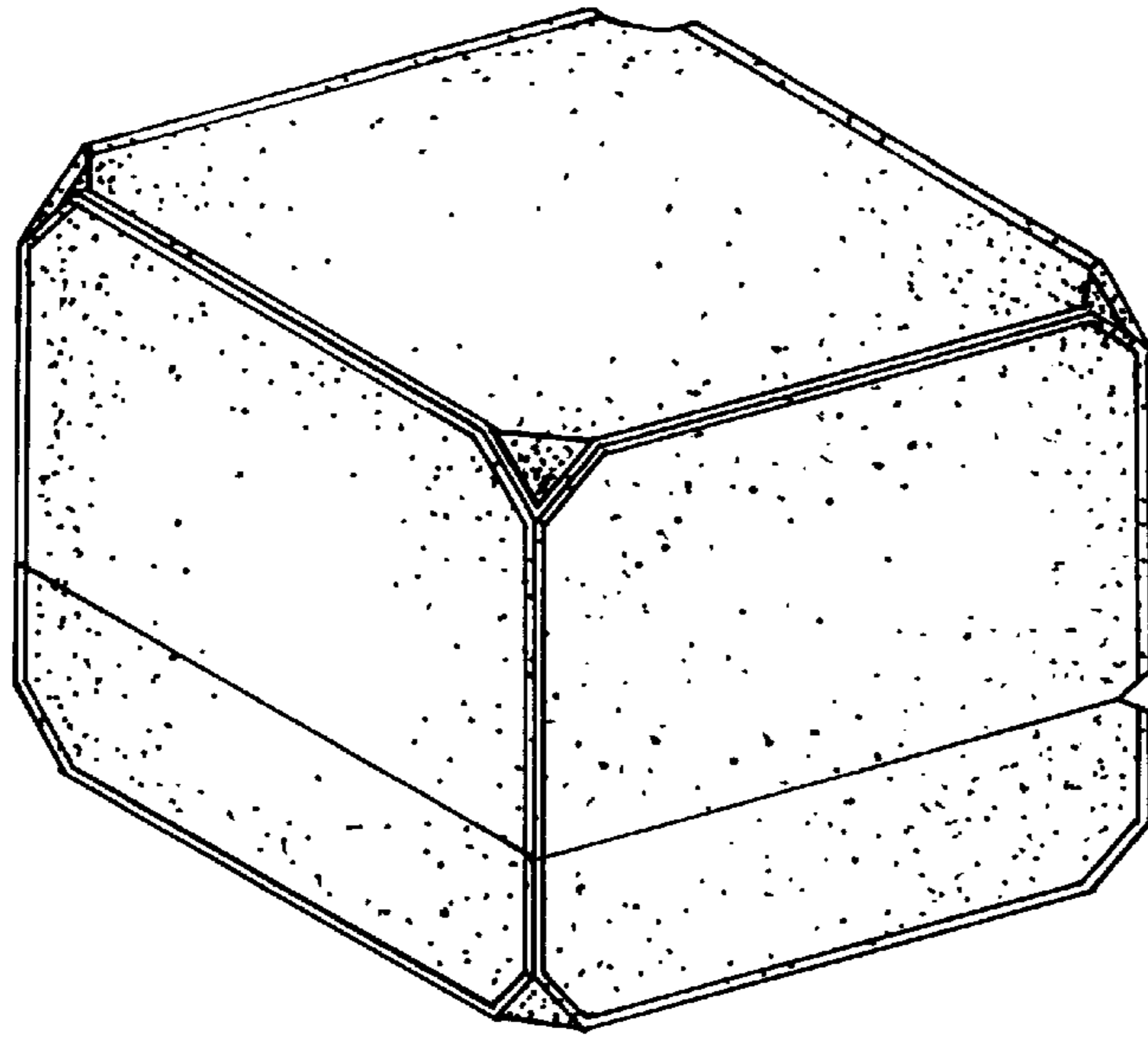

FIG. 1

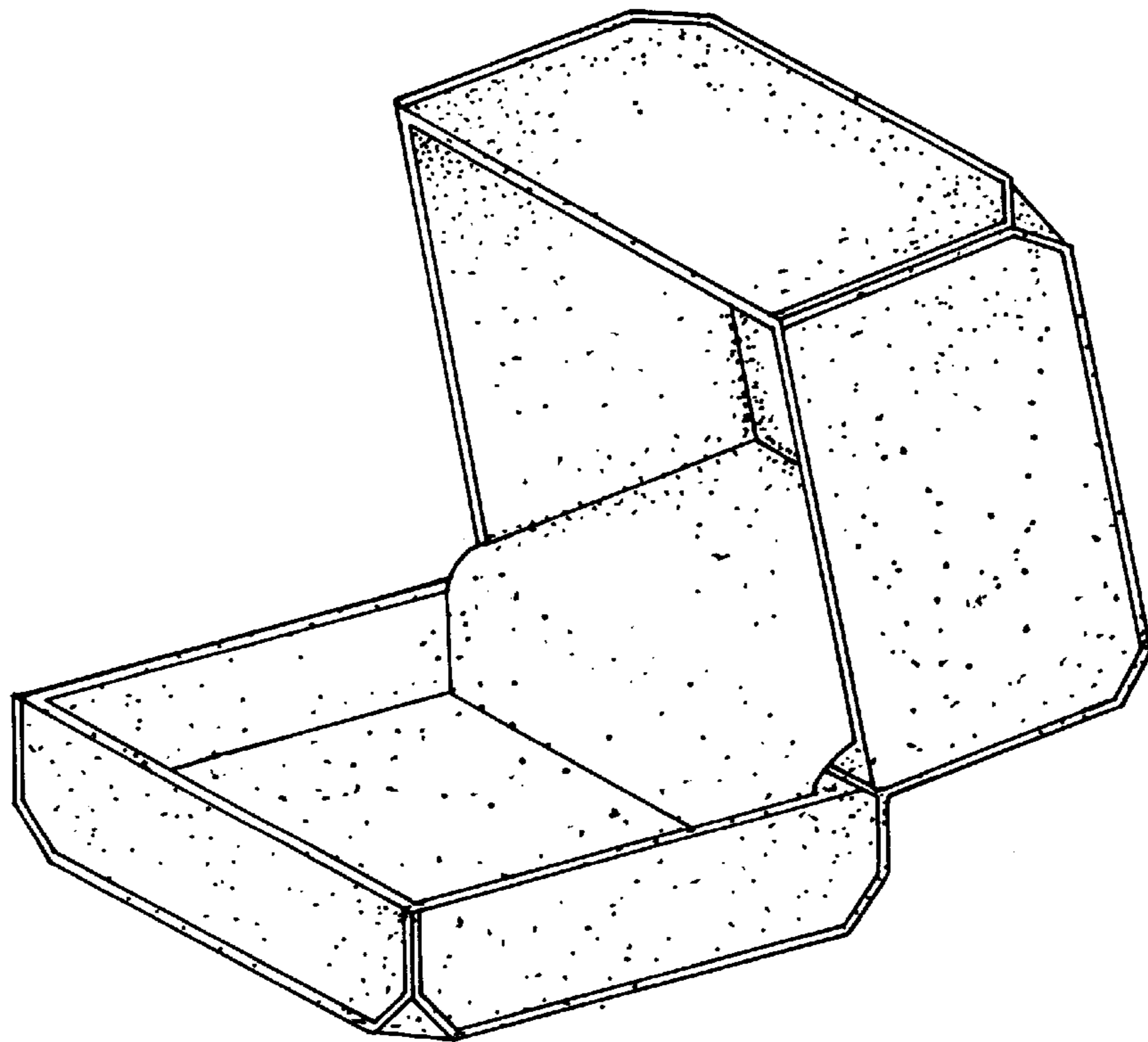

FIG. 2

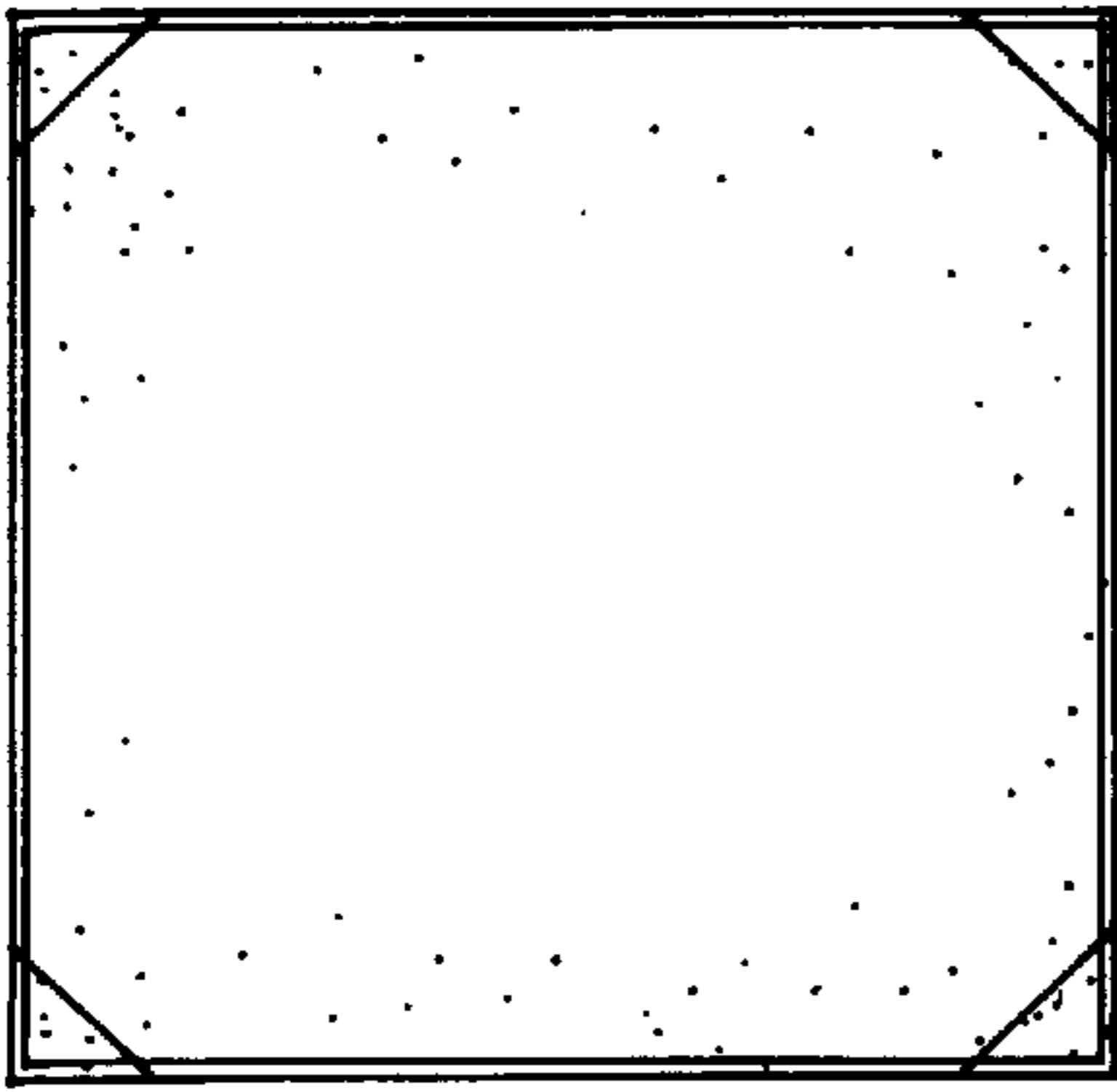

FIG. 3

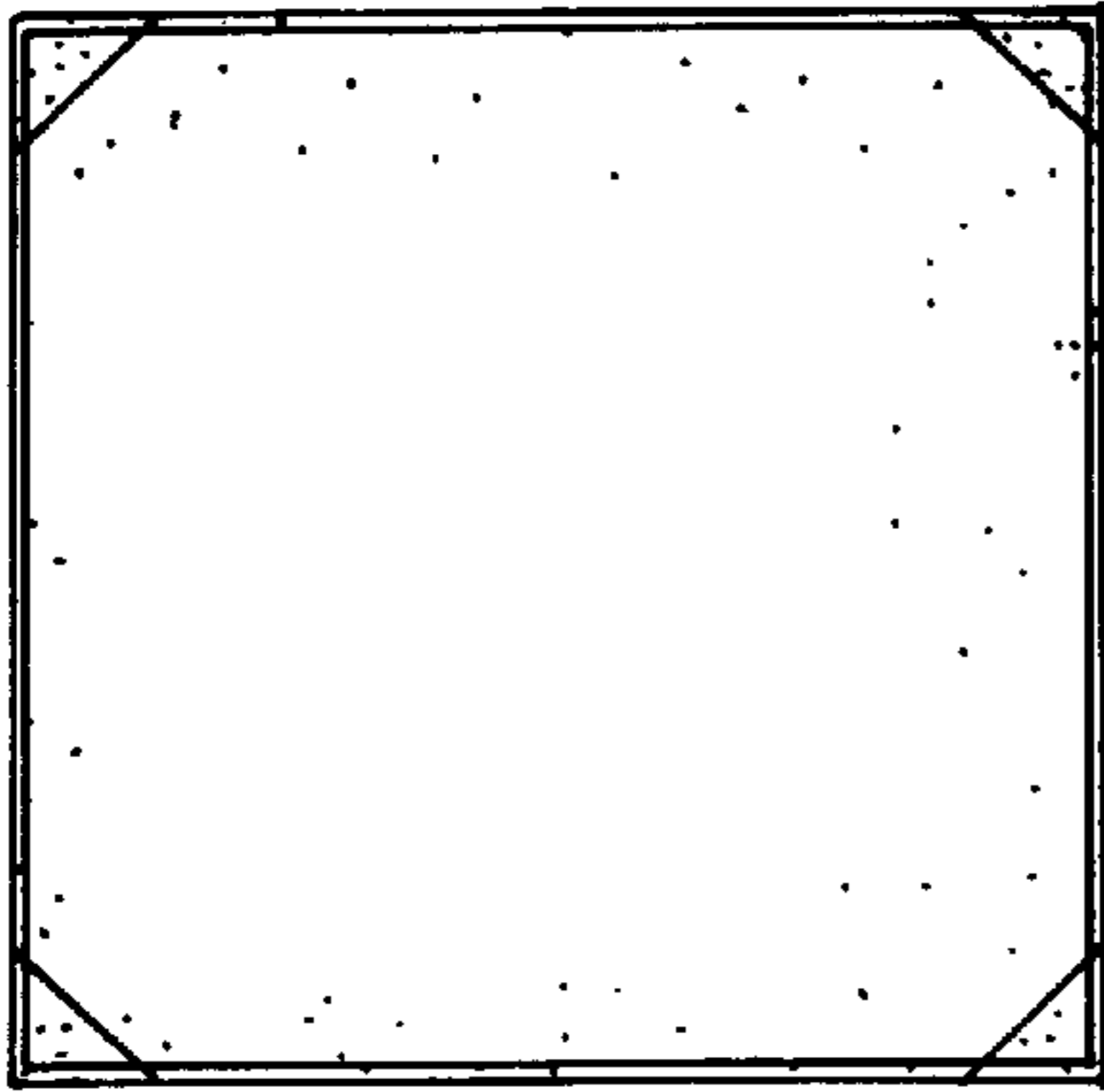

FIG. 4

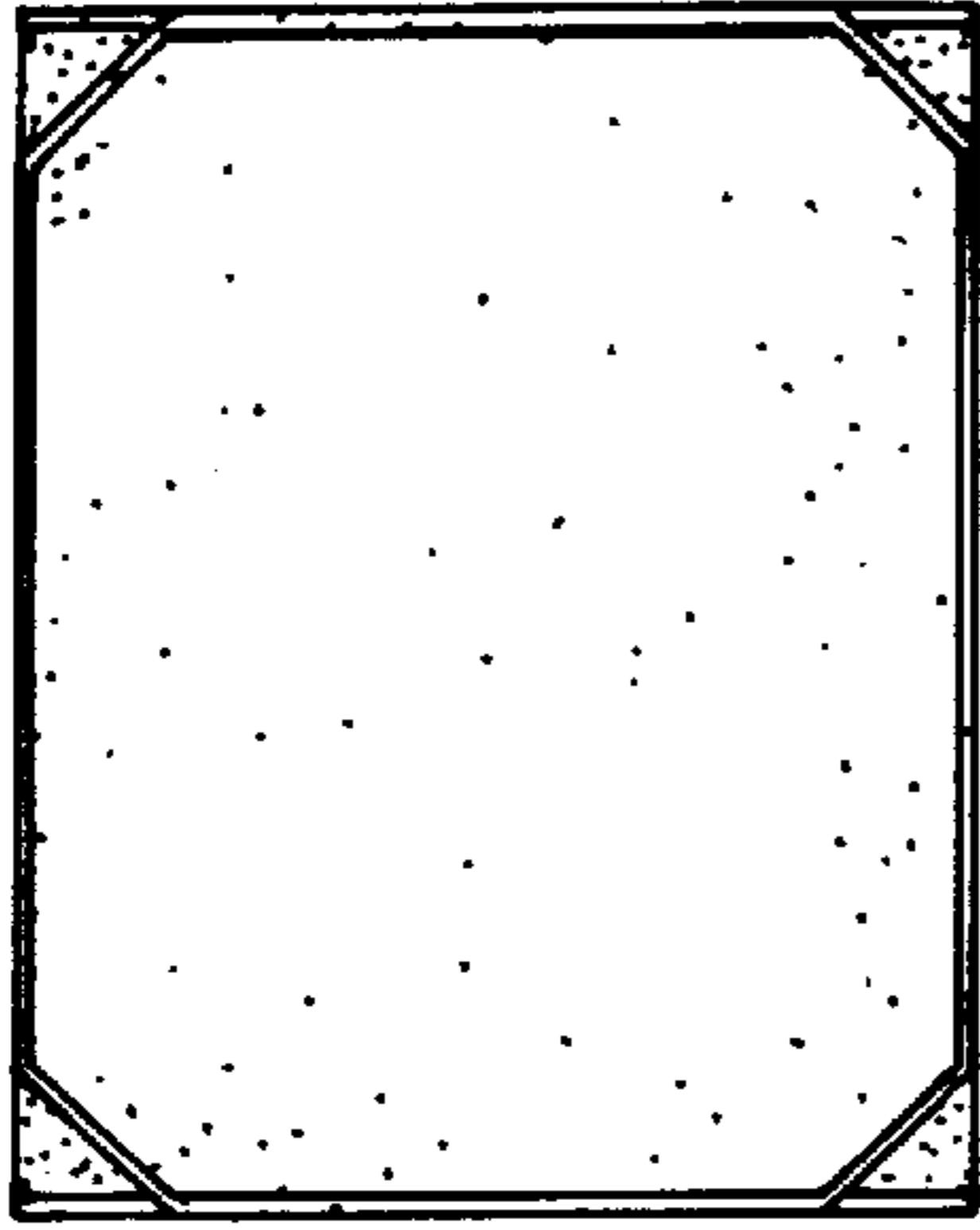

FIG. 6

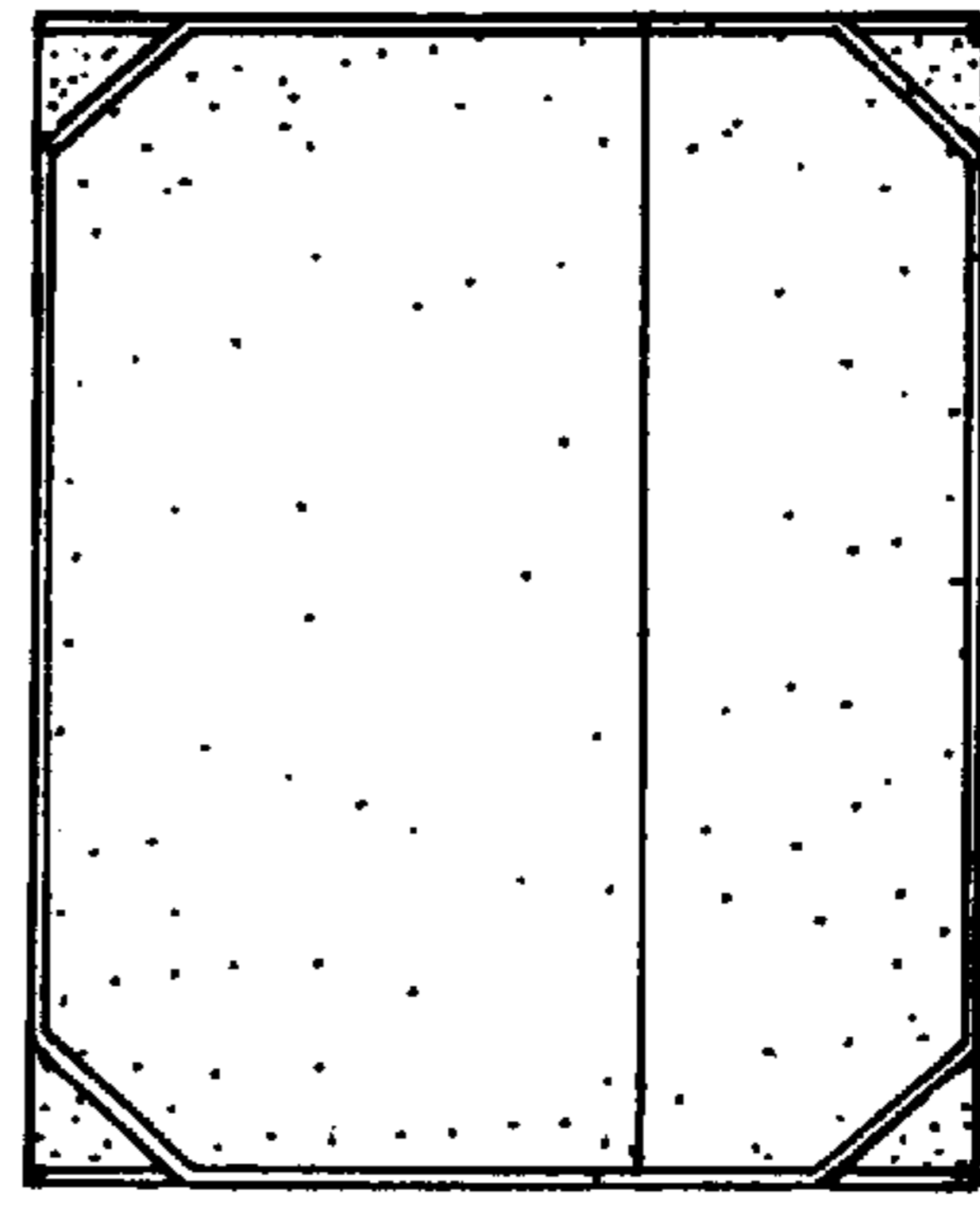

FIG. 5

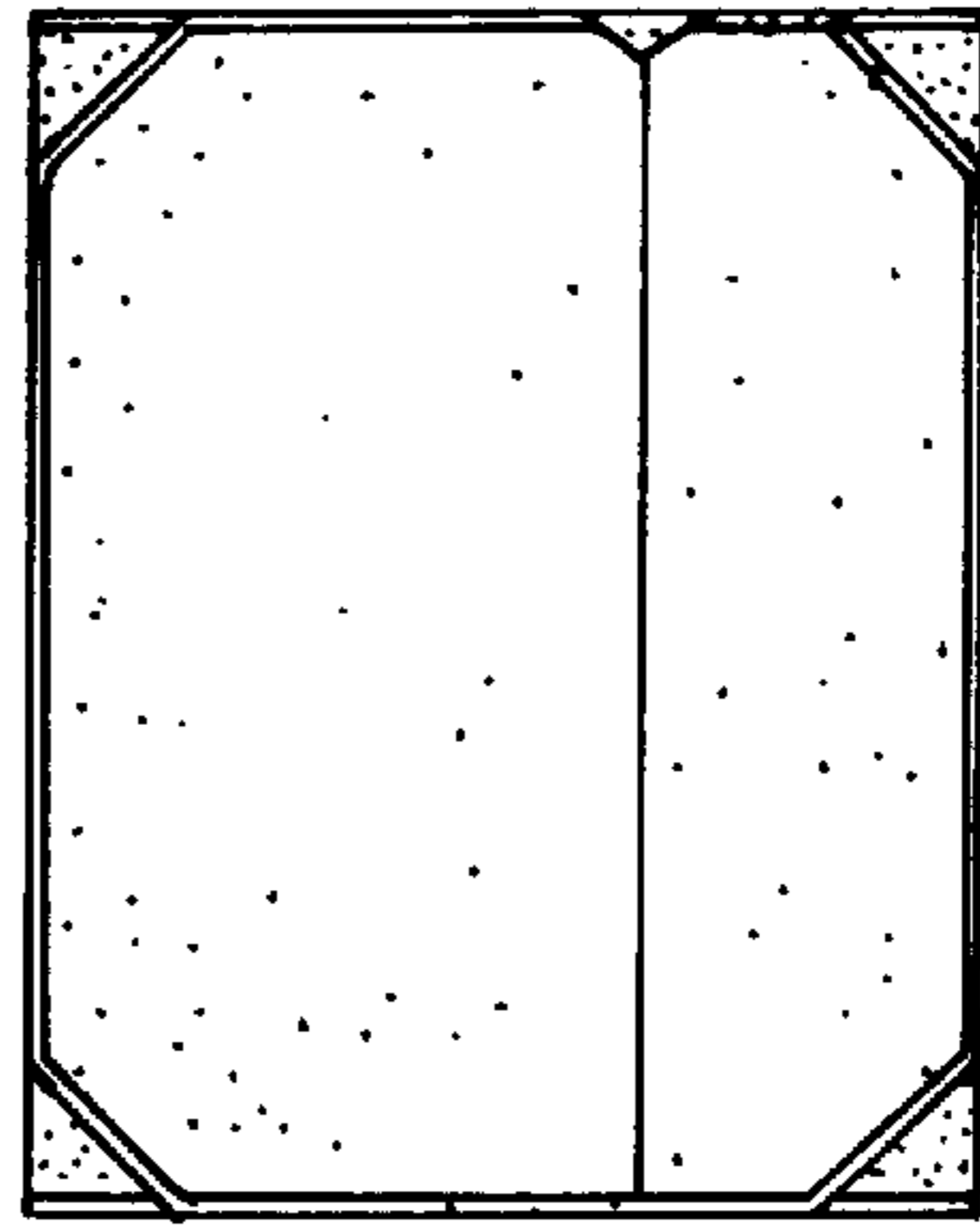

FIG. 7

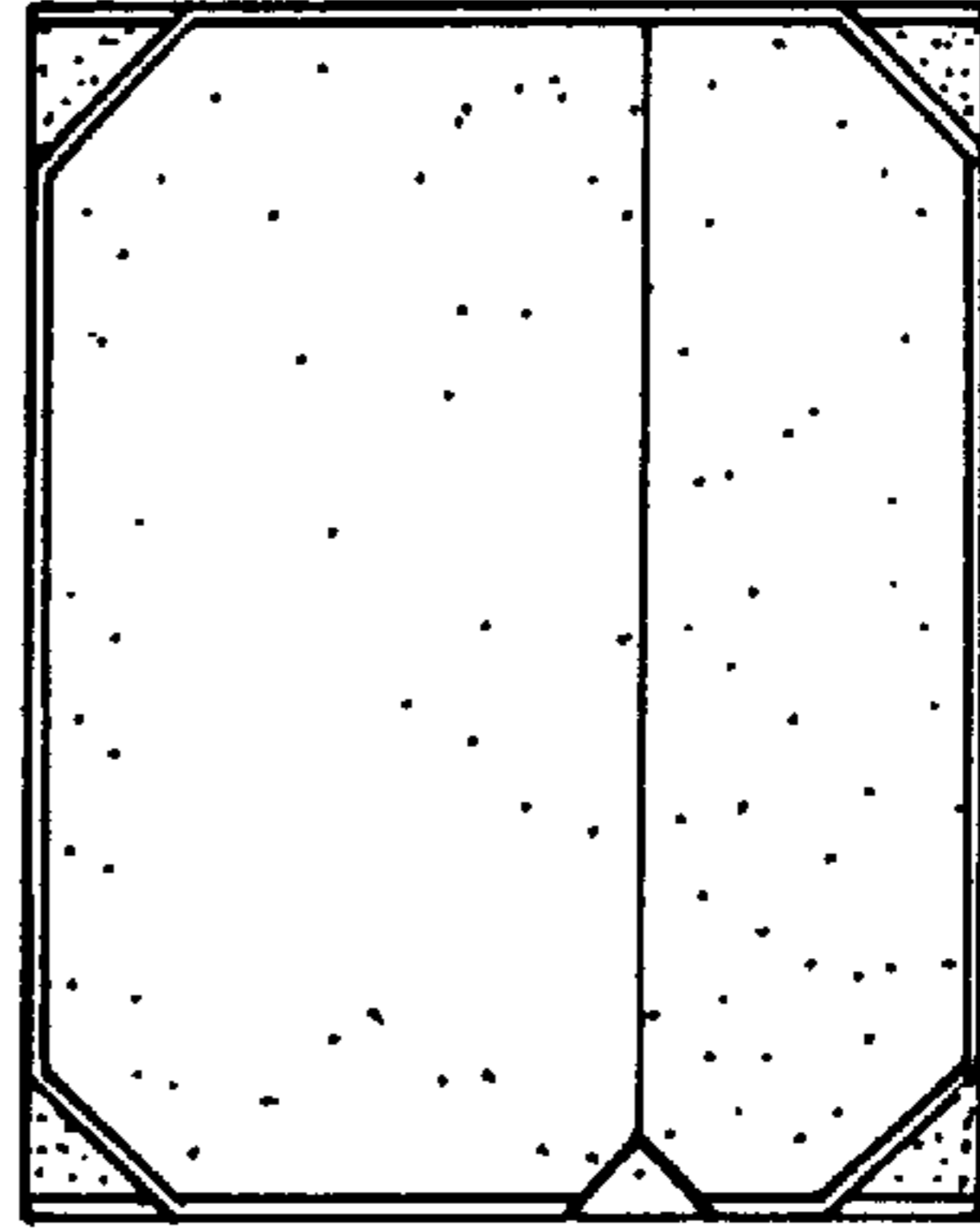

FIG. 8