



US00D401832S

United States Patent [19]

Keklak et al.

[11] **Patent Number: Des. 401,832**

[45] **Date of Patent: **Dec. 1, 1998**

[54] **LOCKING SAFETY UTILITY KNIFE**

[75] Inventors: **Ronald Keklak**, Amston, Conn.;
Michael V. Couture, South Hadley,
Mass.

[73] Assignee: **P.S.I. Inc.**, South Hadley, Mass.

[**] Term: **14 Years**

[21] Appl. No.: **65,222**

[22] Filed: **Jan. 24, 1997**

[51] **LOC (6) Cl.** **08-03**

[52] **U.S. Cl.** **D8/99**

[58] **Field of Search** D8/98, 99; D22/118;
30/151, 152, 153, 154, 155, 156, 157, 158,
159, 160, 162, 337, 336

[56] **References Cited**

U.S. PATENT DOCUMENTS

D. 305,096	12/1989	Tench et al.	D8/99
D. 347,563	6/1994	Okada	D8/99
D. 348,383	7/1994	Perkins	D8/99
3,448,518	6/1969	Sklar	30/162
4,277,888	7/1981	Szabo	30/162
4,683,656	8/1987	Peyrot et al.	30/162
4,713,885	12/1987	Keklak et al.	30/162
4,761,882	8/1988	Silverstein	30/162
4,823,463	4/1989	Lemaire	30/162

4,949,458	8/1990	Davis et al.	30/162
4,953,293	9/1990	Sterlacci	30/162
5,303,474	4/1994	Keklak et al.	30/162
5,426,855	6/1995	Keklak et al.	30/162

Primary Examiner—Philip S. Hyder
Attorney, Agent, or Firm—Shoemaker and Mattare, Ltd

[57] **CLAIM**

The ornamental design for a locking safety utility knife, as shown and described.

DESCRIPTION

FIG. 1 is a left side elevational view of a locking safety utility knife, showing our new design, with its blade extended;

FIG. 2 is a left side elevational view thereof, wherein the the handle is extended and the blade is retracted;

FIG. 3 is a right side elevational view thereof, wherein the the handle is extended and the blade is retracted;

FIG. 4 is a front elevational view thereof;

FIG. 5 is a rear elevational view thereof;

FIG. 6 is a top plan view thereof; and;

FIG. 7 is a bottom plan view thereof;

FIG. 8 is a front elevational view thereof, whereing the handle is extended; and,

FIG. 9 is a rear elevational view thereof, wherein the handle is extended.

1 Claim, 6 Drawing Sheets

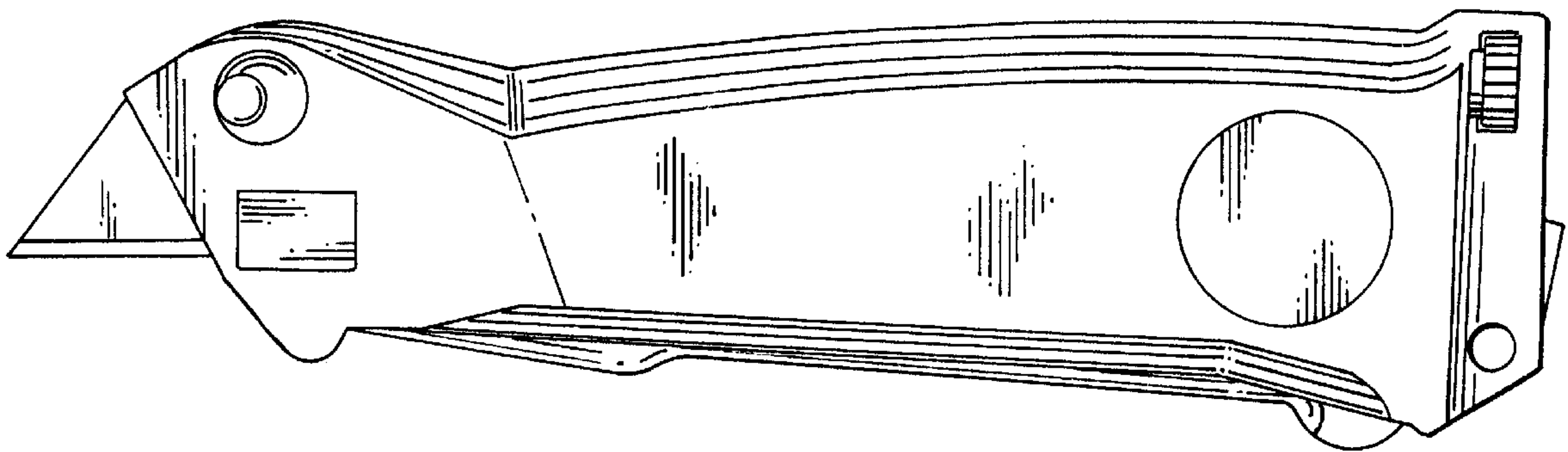

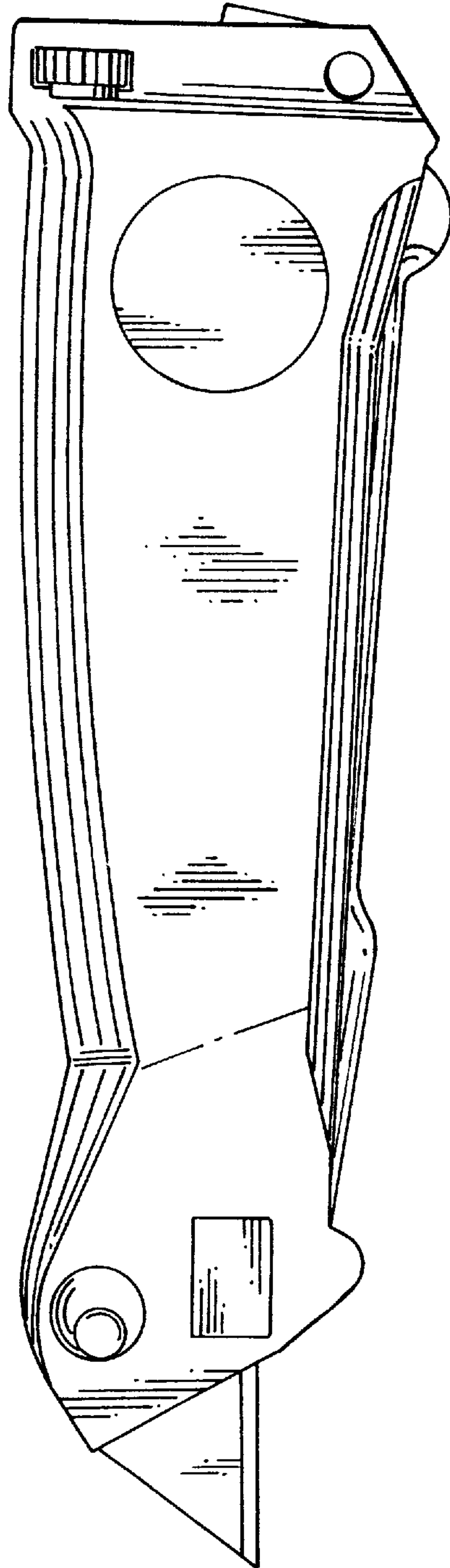

FIG. 1

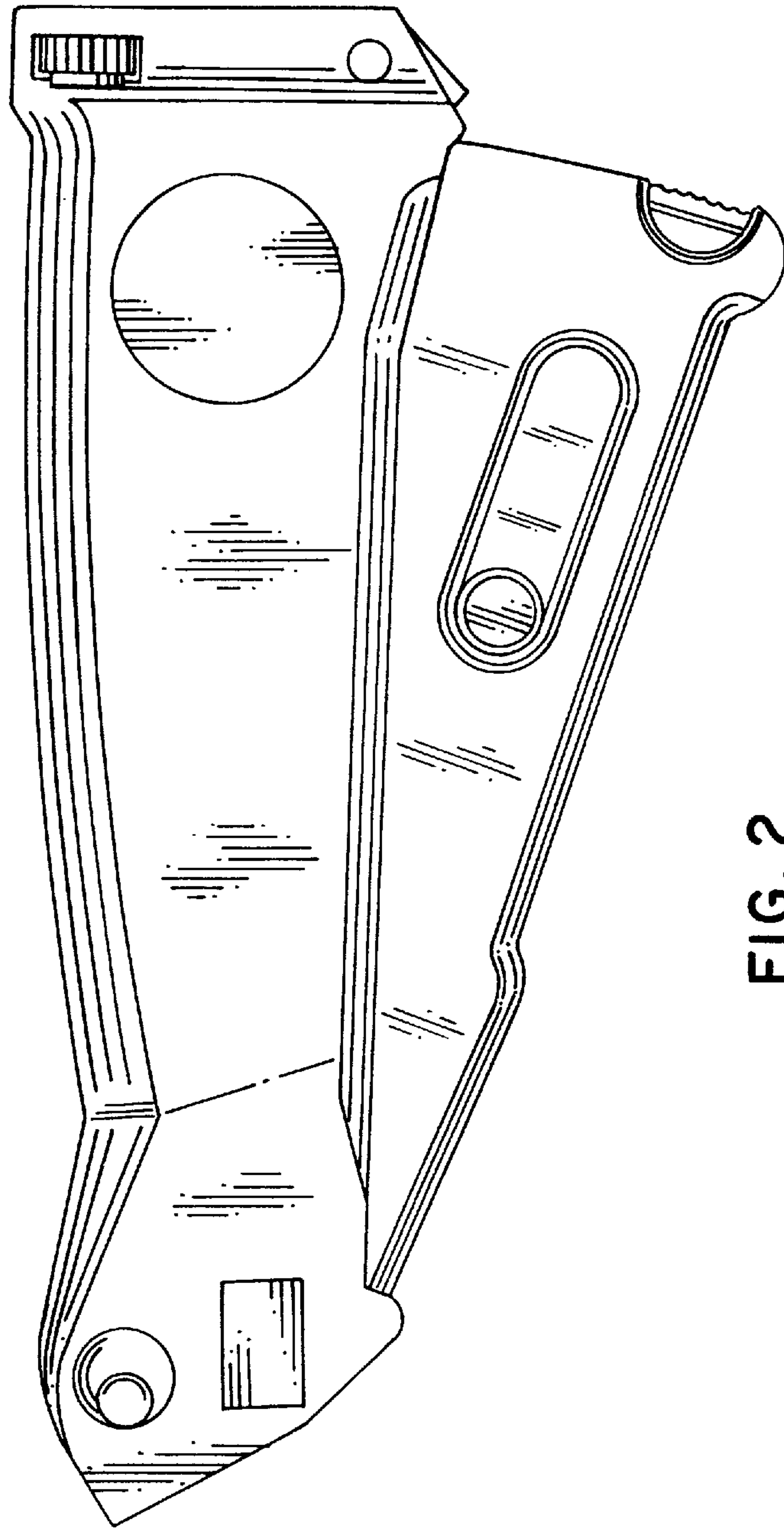

FIG. 2

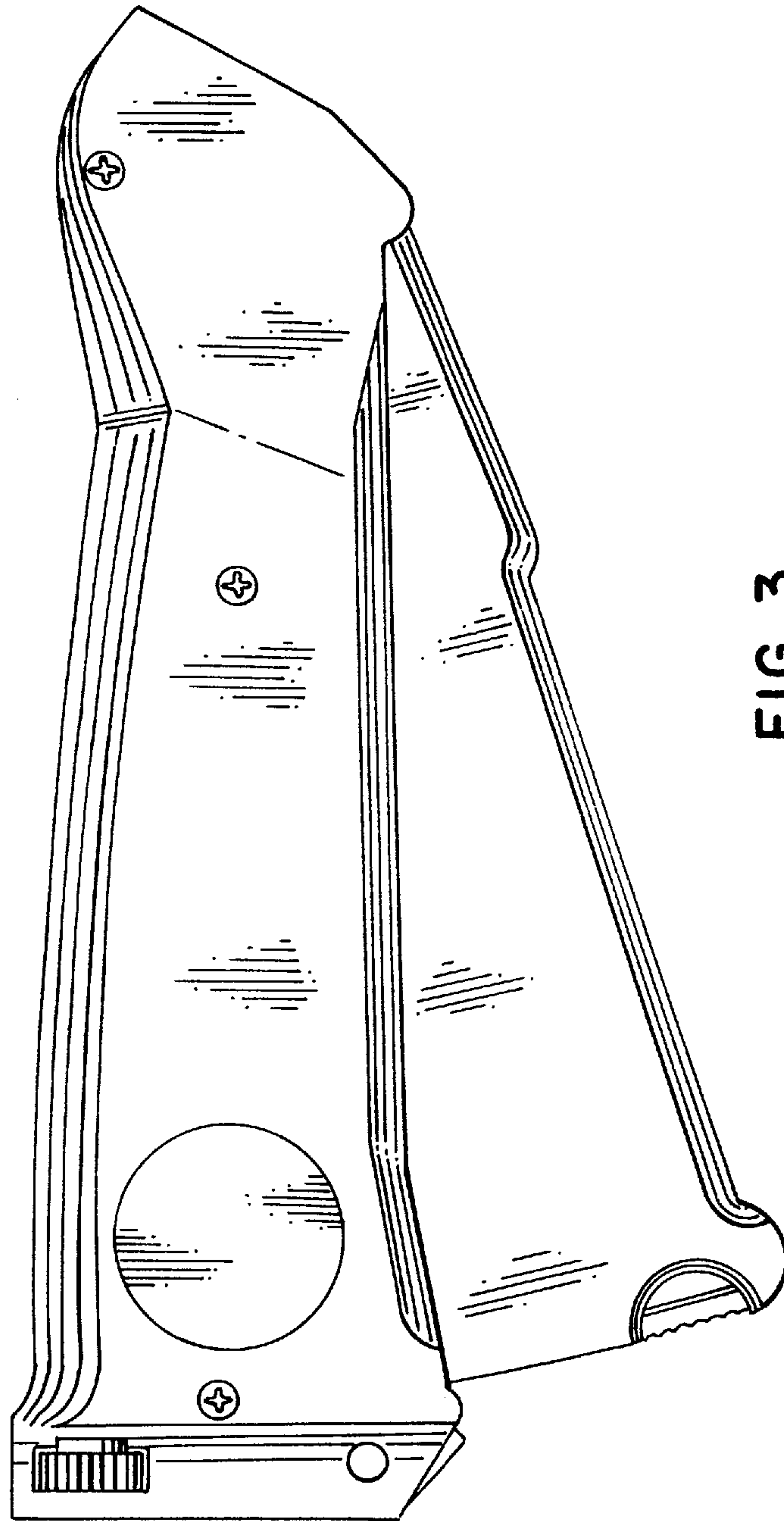

FIG. 3

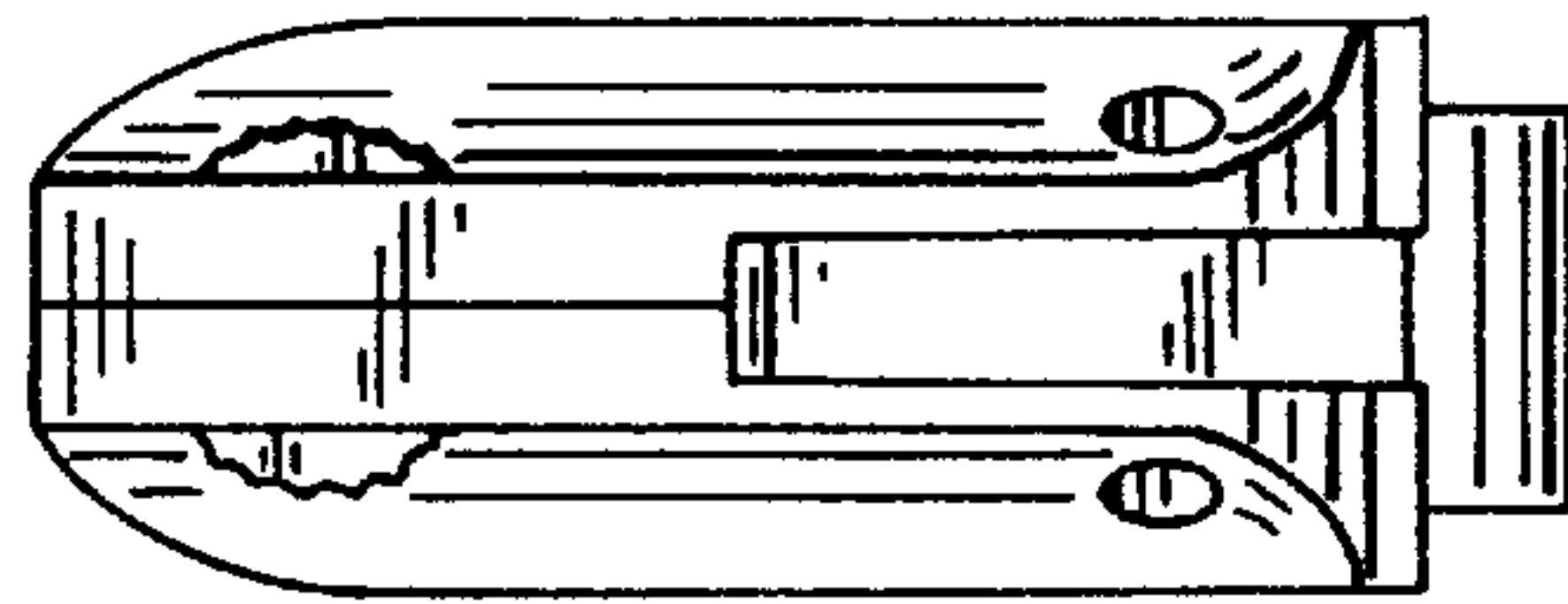

FIG. 5

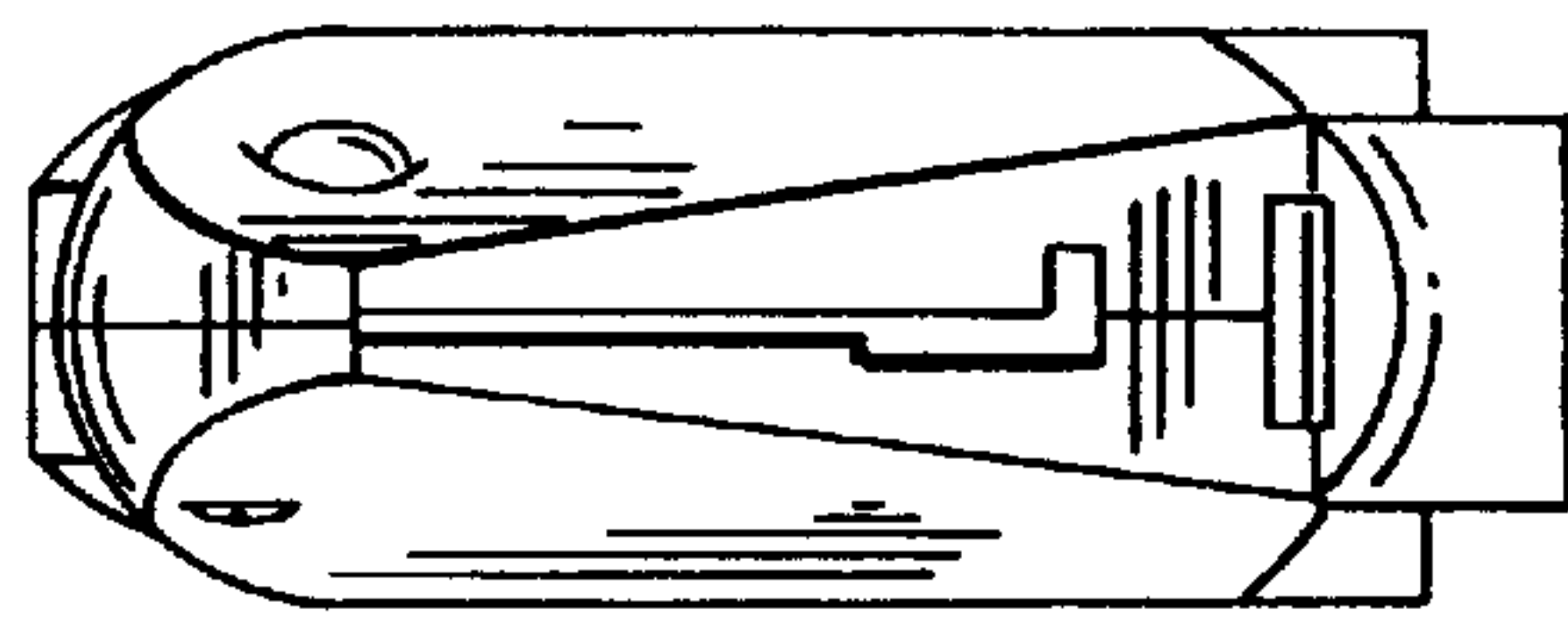

FIG. 4

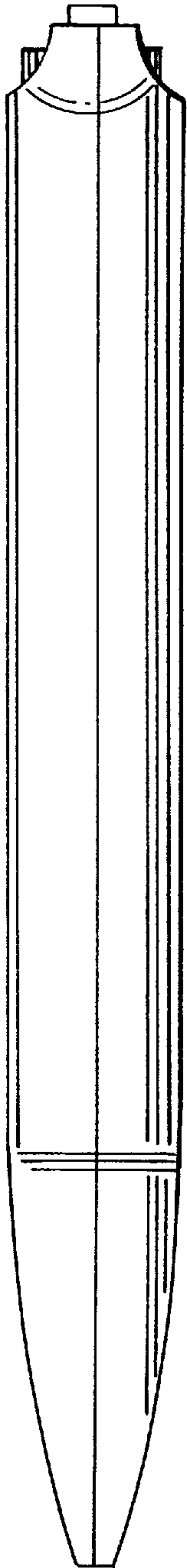

FIG. 6

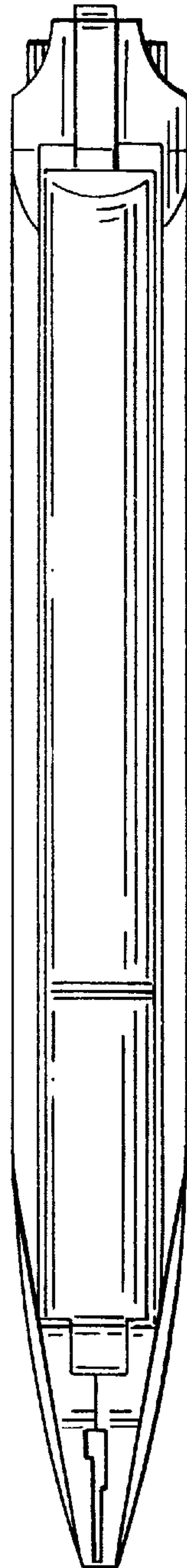

FIG. 7

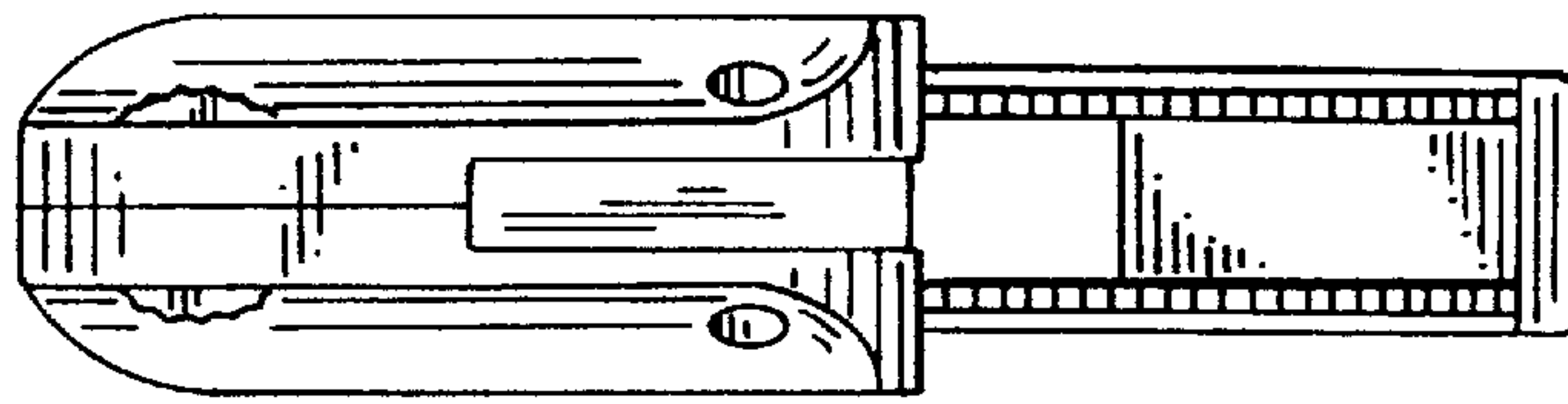

FIG. 9

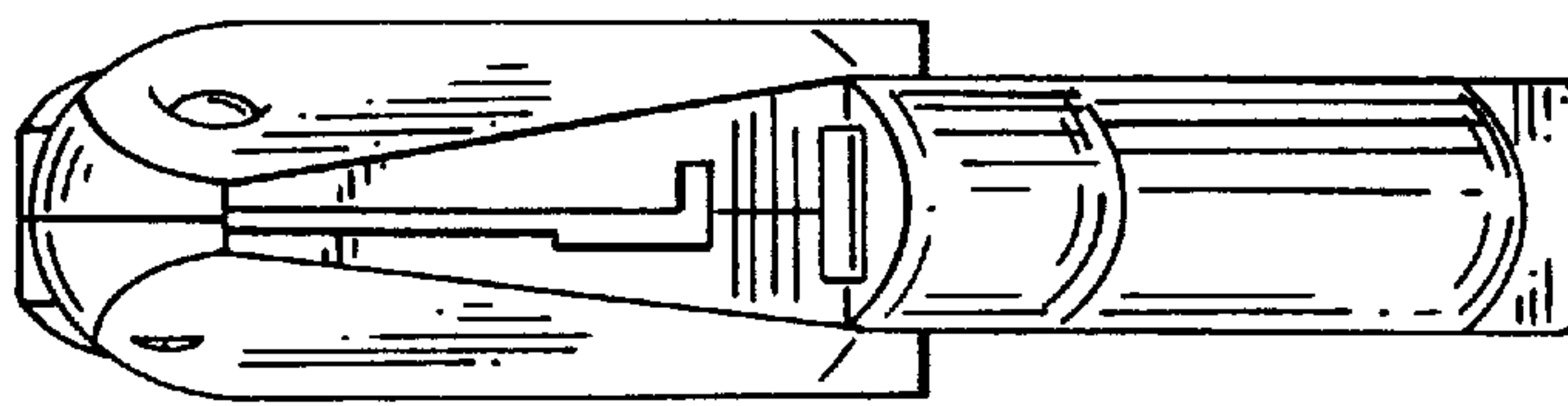

FIG. 8