



US00D401821S

United States Patent [19]

Gramera

[11] Patent Number: **Des. 401,821**

[45] Date of Patent: ****Dec. 1, 1998**

[54] SET OF COUPLED BLOCK WEIGHTS FOR SEALING CARPET SEAMS

2,814,274 11/1957 Diamond 470/209
2,814,275 11/1957 Diamond 16/403

[76] Inventor: **Robert E. Gramera**, 704 C.R. 220, Durango, Colo. 81301

Primary Examiner—Caron D. Veynar

[**] Term: **14 Years**

[57] **CLAIM**

The ornamental design for a set of coupled block weights for sealing carpet seams, as shown and described.

[21] Appl. No.: **69,988**

DESCRIPTION

[22] Filed: **Apr. 21, 1997**

FIG. 1 is an overall, left to right, perspective view of a set of coupled block weights for sealing carpet seams, showing my new design.

[51] LOC (6) Cl. **08-05**

[52] U.S. Cl. **D8/15**

[58] Field of Search D8/15; 16/403, 16/404, DIG. 8; 100/265; 470/209

FIG. 2 is a top view thereof;

FIG. 3 is an elevational view for the right side, thereof;

FIG. 4 is a bottom view thereof;

FIG. 5 is a left view thereof;

FIG. 6 is a front view thereof; and,

FIG. 7 is a rear view thereof.

[56] **References Cited**

U.S. PATENT DOCUMENTS

2,062,242 11/1936 Voosen et al. 211/51
2,514,334 7/1950 Niedermeyer 100/265

1 Claim, 4 Drawing Sheets

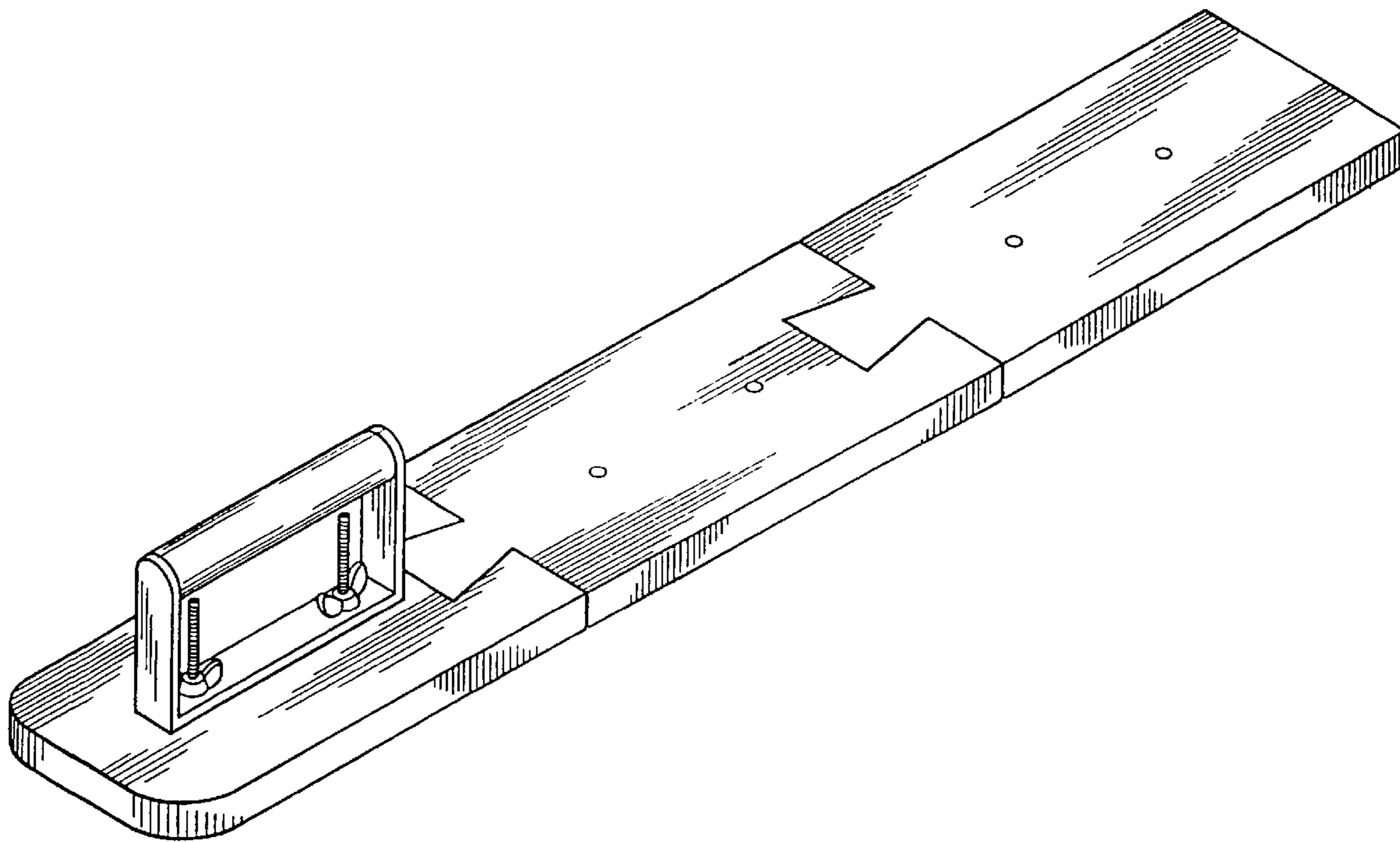

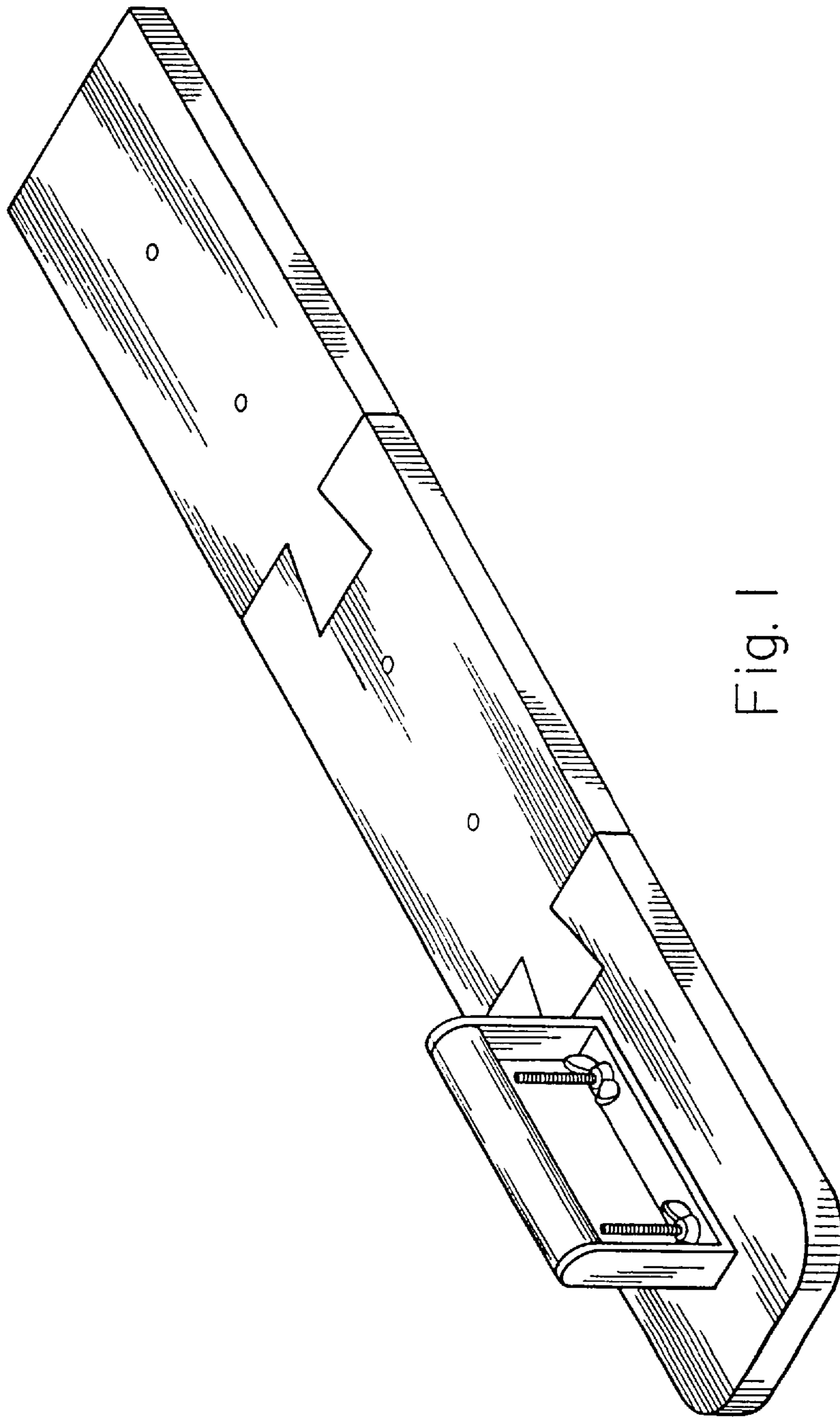

Fig. 1

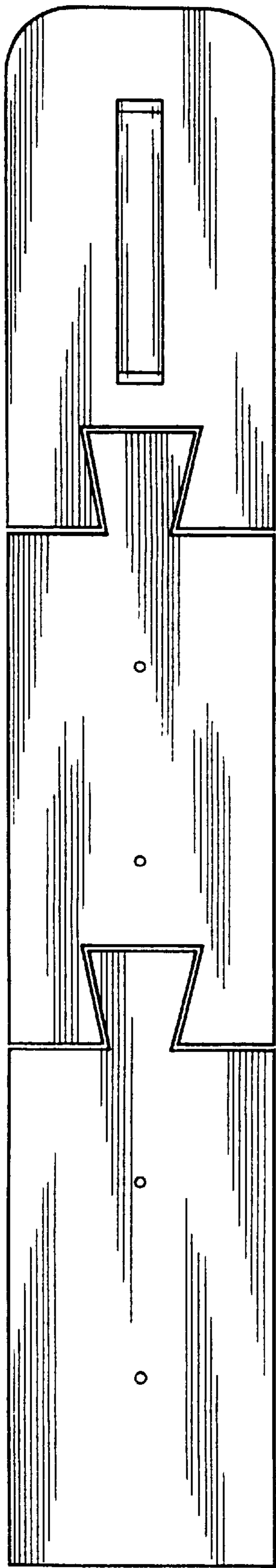

Fig. 2

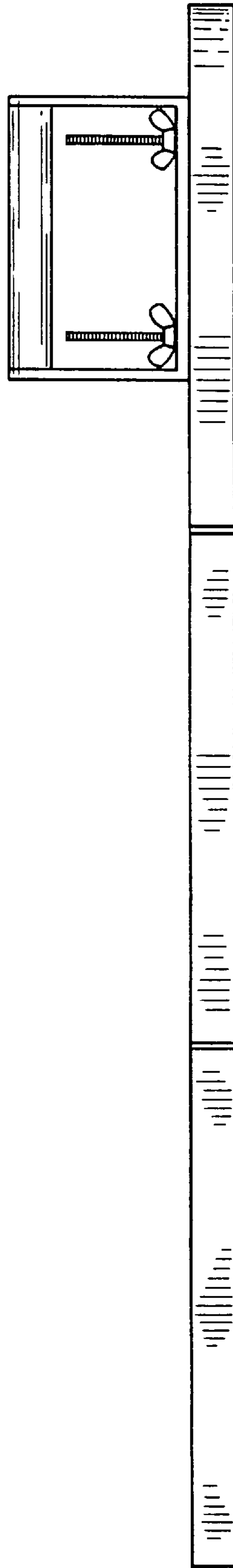

Fig. 3

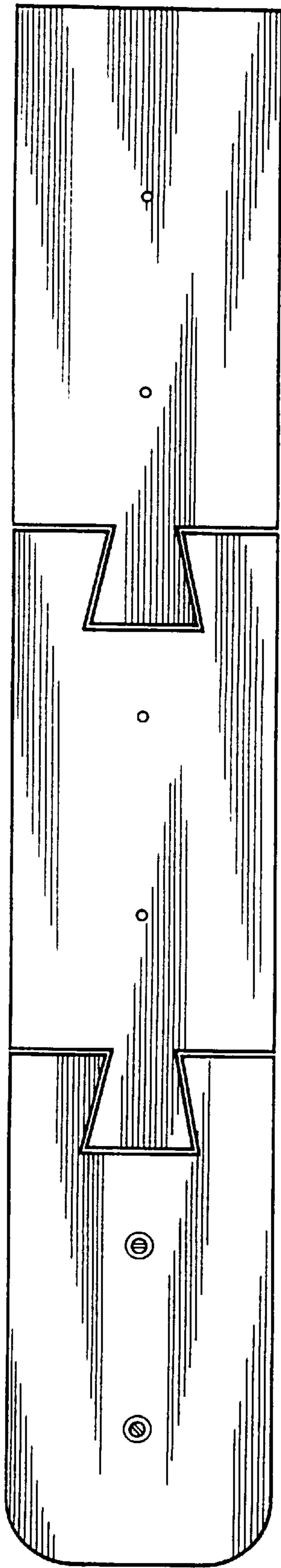

Fig. 4

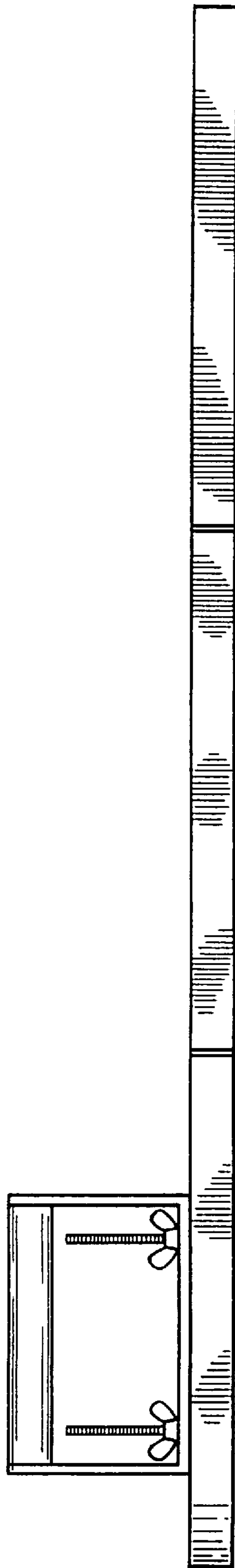

Fig. 5

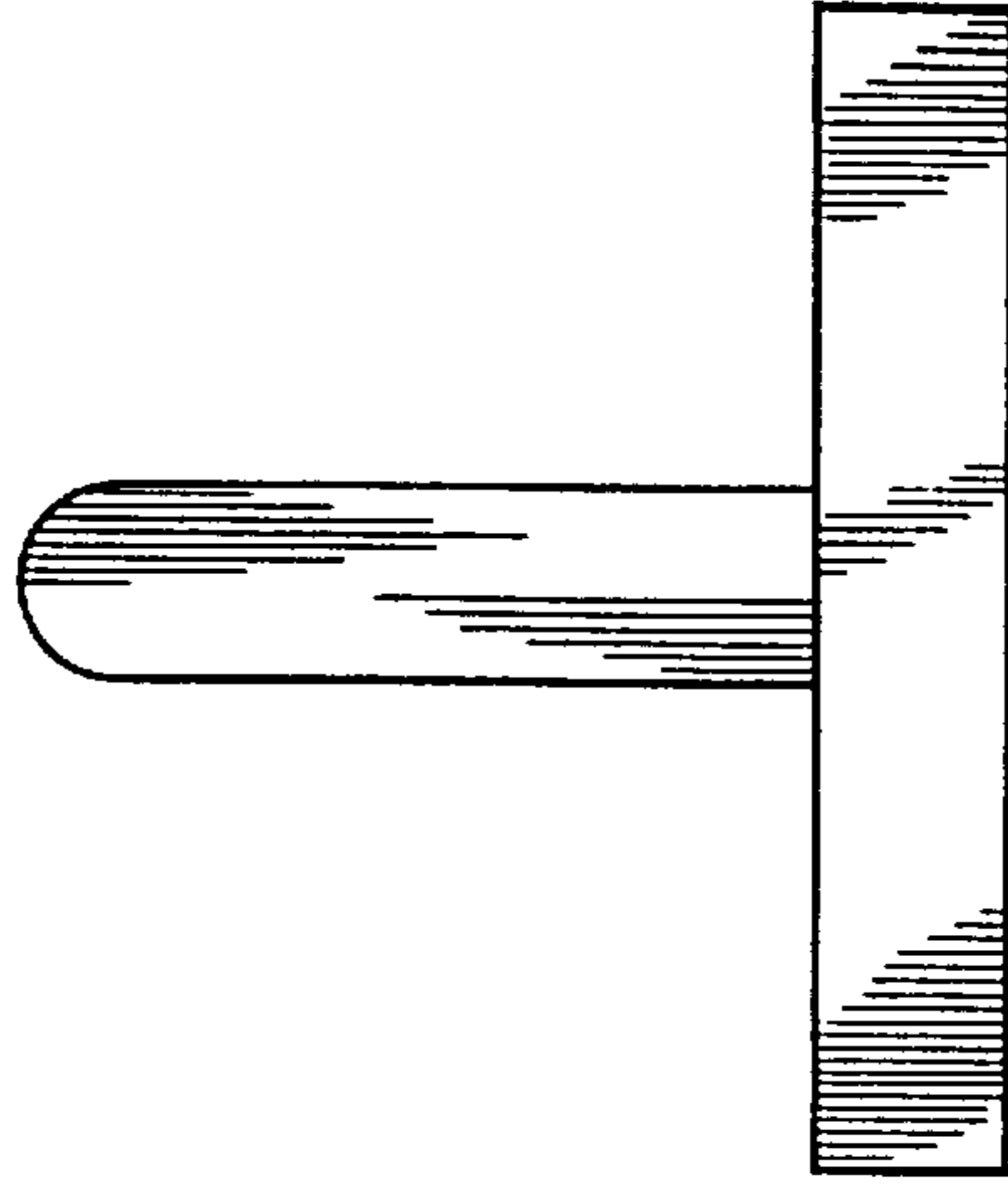

Fig. 7

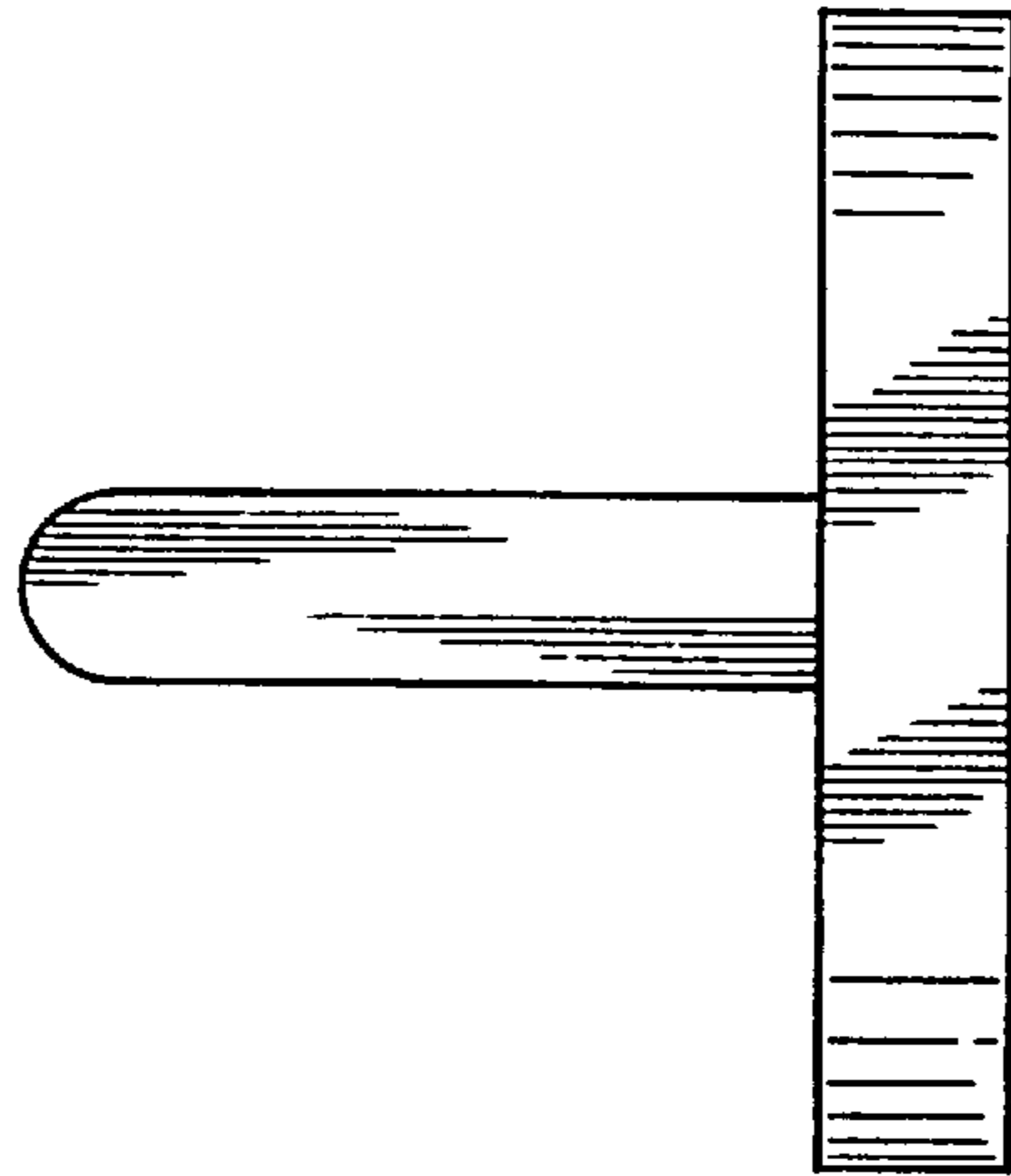

Fig. 6