

US00D401765S

# United States Patent [19] Soutullo

[11] **Patent Number: Des. 401,765**

[45] **Date of Patent: \*\*Dec. 1, 1998**

[54] **PAINT BRUSH COVER**

4,899,877 2/1990 Kiernan ..... 206/470 X

[76] Inventor: **Gary Soutullo**, 2709 Lloys La., Mobile, Ala. 36693

*Primary Examiner*—Alan P. Douglas  
*Assistant Examiner*—Lavone D. Tabor  
*Attorney, Agent, or Firm*—Robert N. Montgomery

[\*\*] Term: **14 Years**

[21] Appl. No.: **70,077**

[22] Filed: **Apr. 28, 1997**

[57] **CLAIM**

The ornamental design for a paint brush cover, as shown and described.

[51] **LOC (6) Cl.** ..... **04-99**

**DESCRIPTION**

[52] **U.S. Cl.** ..... **D4/199; D9/415**

FIG. 1 is an isometric view of the paint brush cover in the open position;

[58] **Field of Search** ..... D4/199; D9/415, D9/420, 423-426, 430, 432, 433; 206/15.3, 361, 362.3, 362.4, 461-465, 470, 471; 220/4.22, 4.23; 229/406

FIG. 2 is an isometric view of the paint brush cover in the closed position;

FIG. 3 is a front elevation view showing the cover in the open position;

[56] **References Cited**

**U.S. PATENT DOCUMENTS**

D. 283,488	4/1986	Stevens	.....	D9/415 X
D. 338,619	8/1993	Mylander et al.	.....	D9/415
1,869,753	8/1932	Kamm	.....	206/361
3,800,998	4/1974	Gask	.....	229/406
4,423,811	1/1984	Knapp	.....	206/362.3

FIG. 4 is a top view;

FIG. 5 is a bottom view;

FIG. 6 is an end view taken along sight line 6—6 in FIG. 4; and,

FIG. 7 is an end view taken along sight line 7—7 in FIG. 4.

**1 Claim, 3 Drawing Sheets**

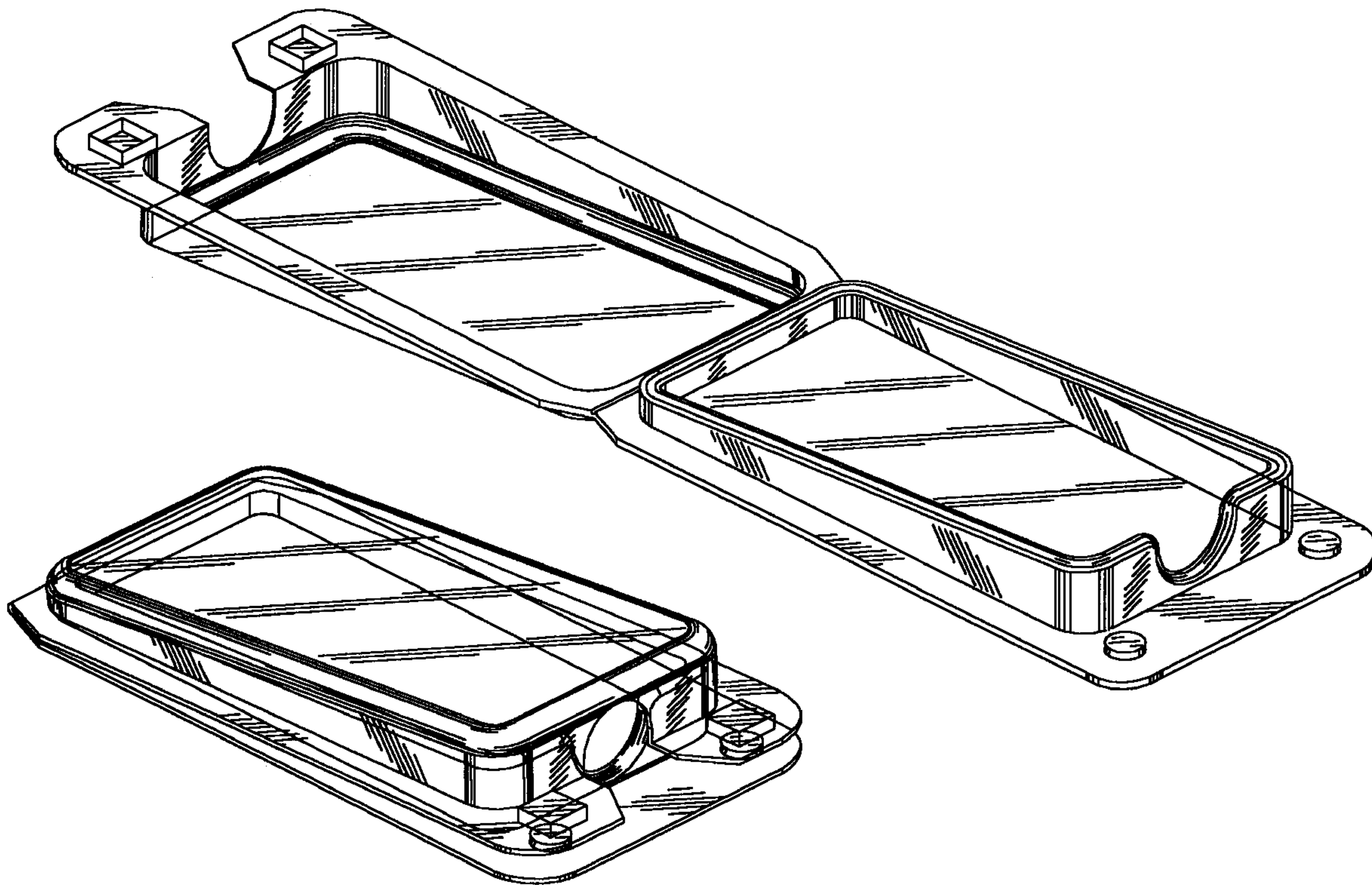

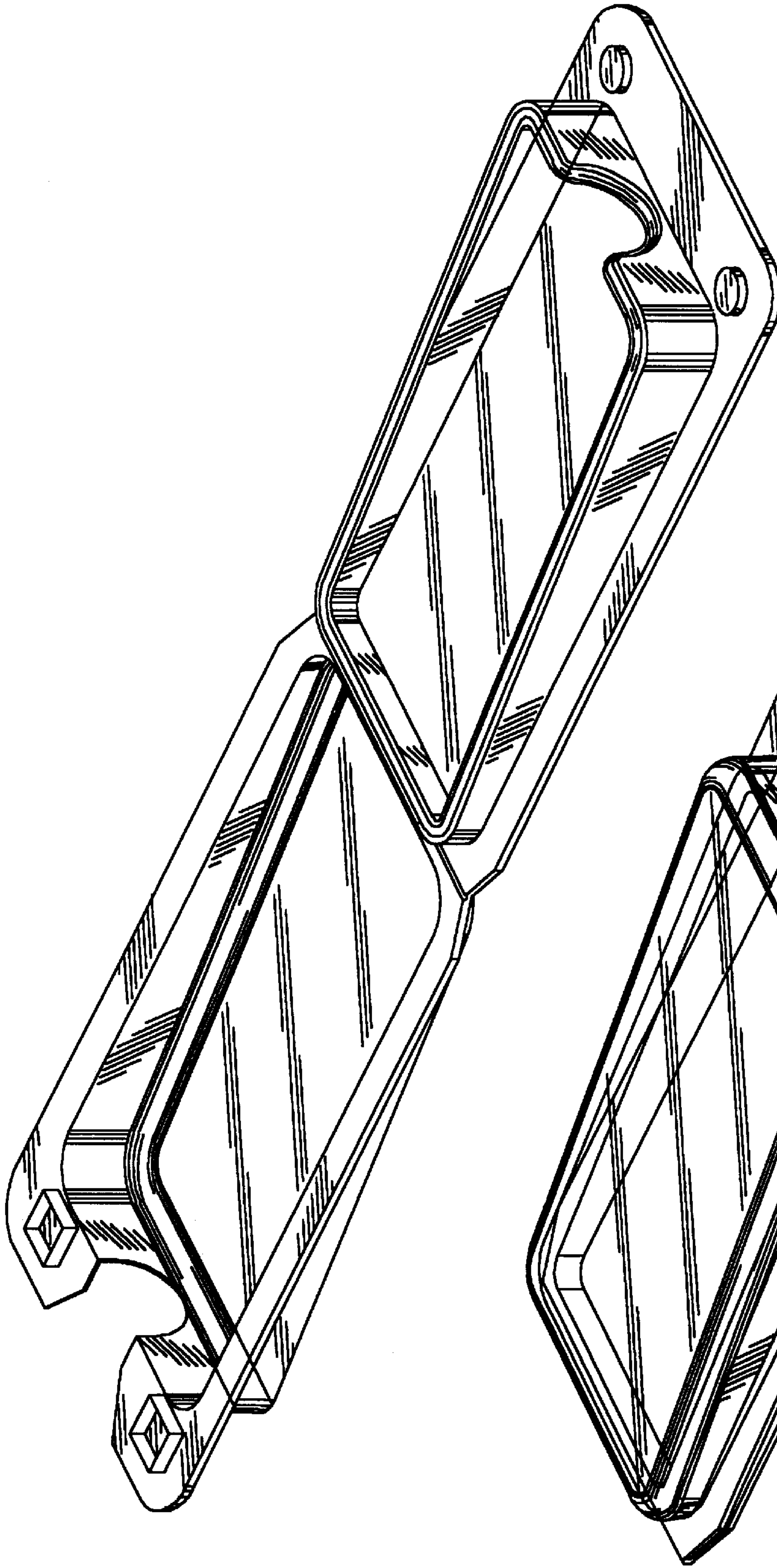

FIG. 1

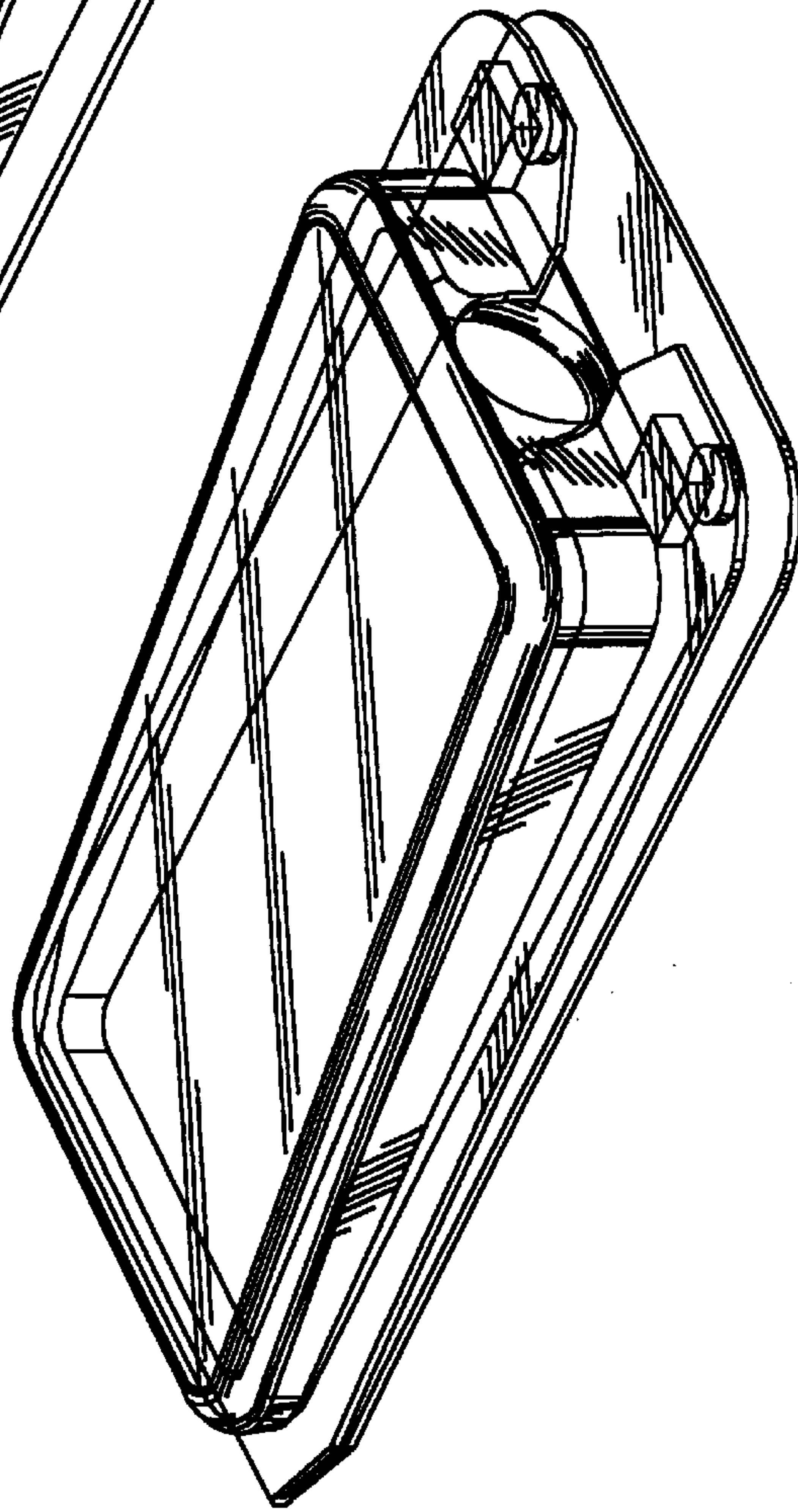

FIG. 2

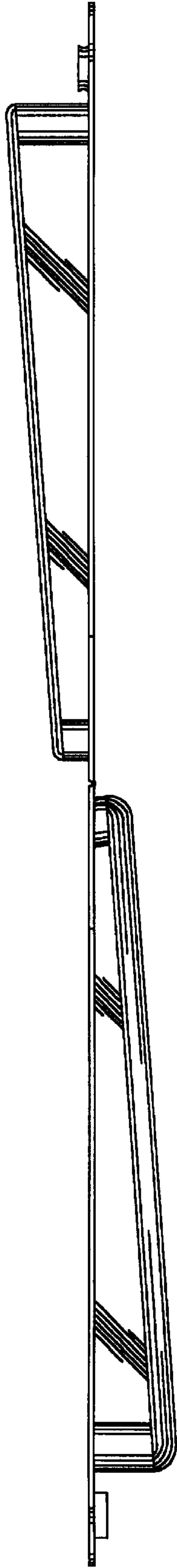

FIG. 3

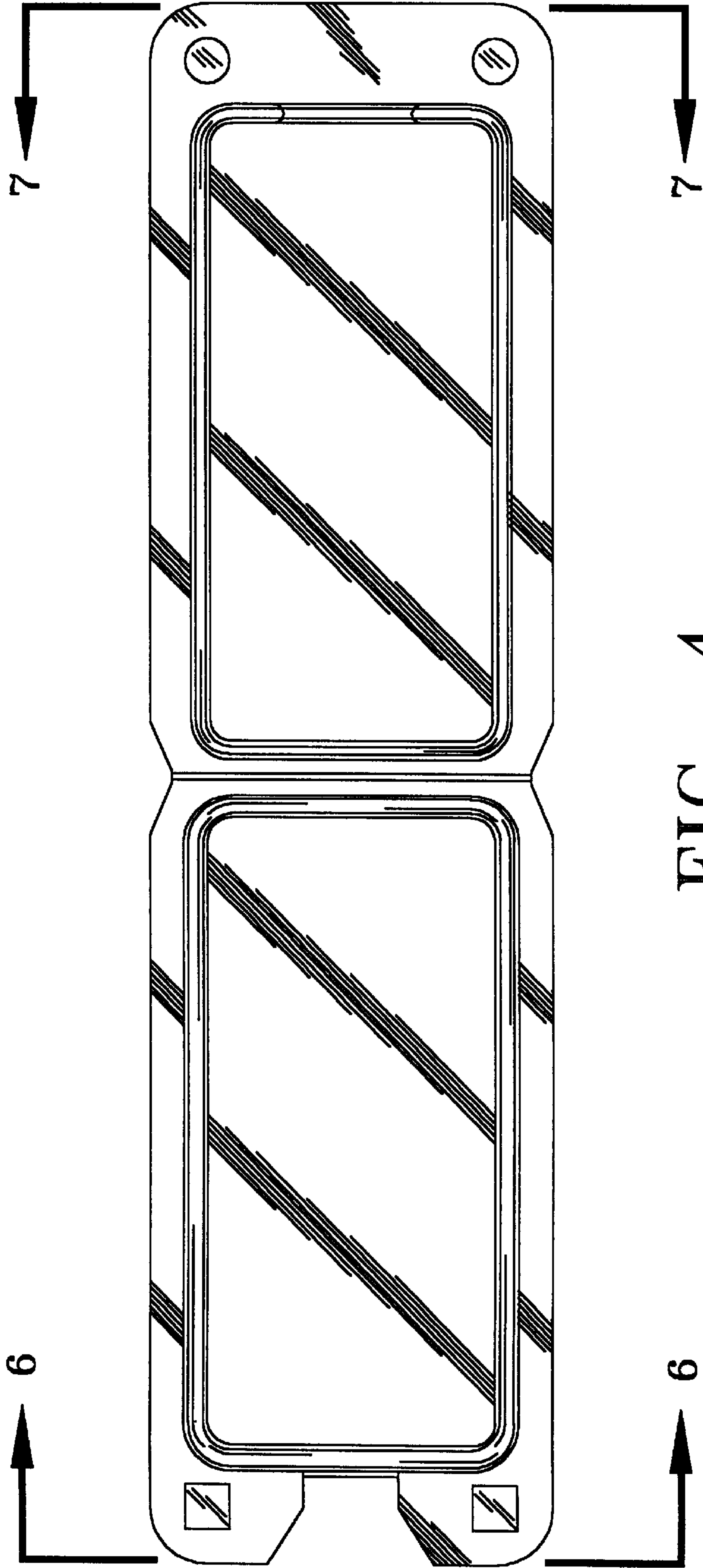

FIG. 4



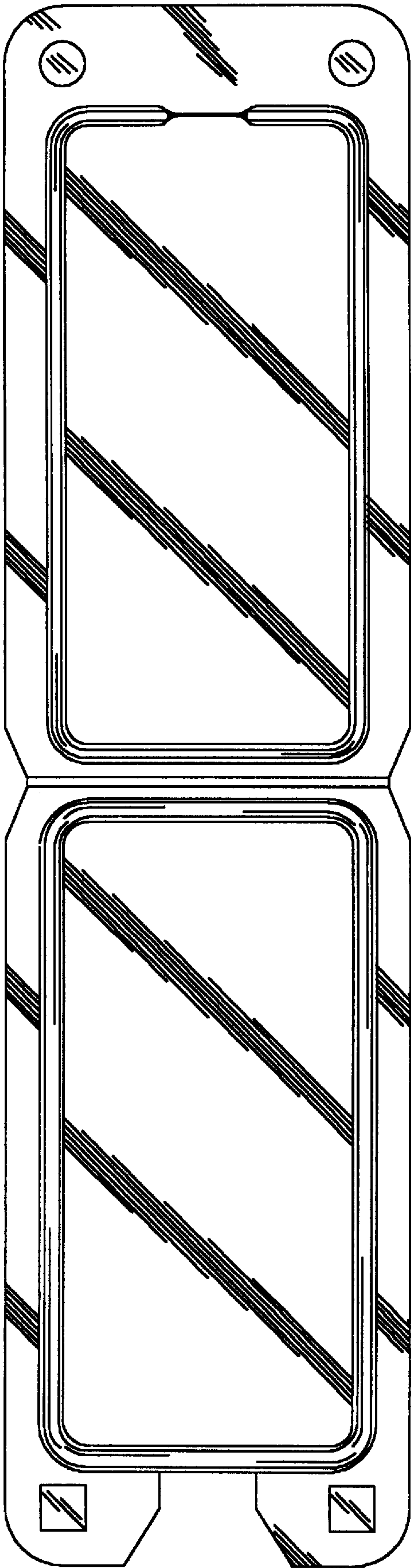

FIG. 5

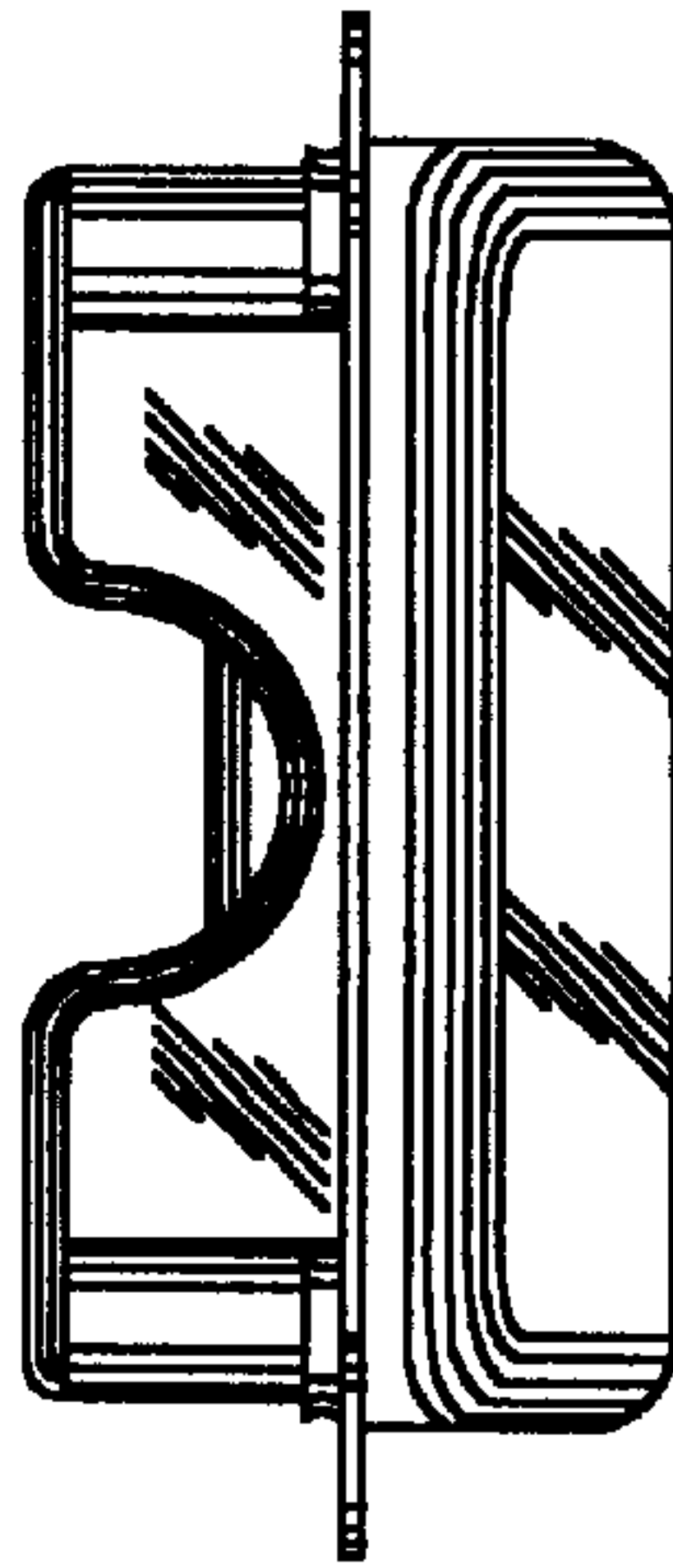

FIG. 7

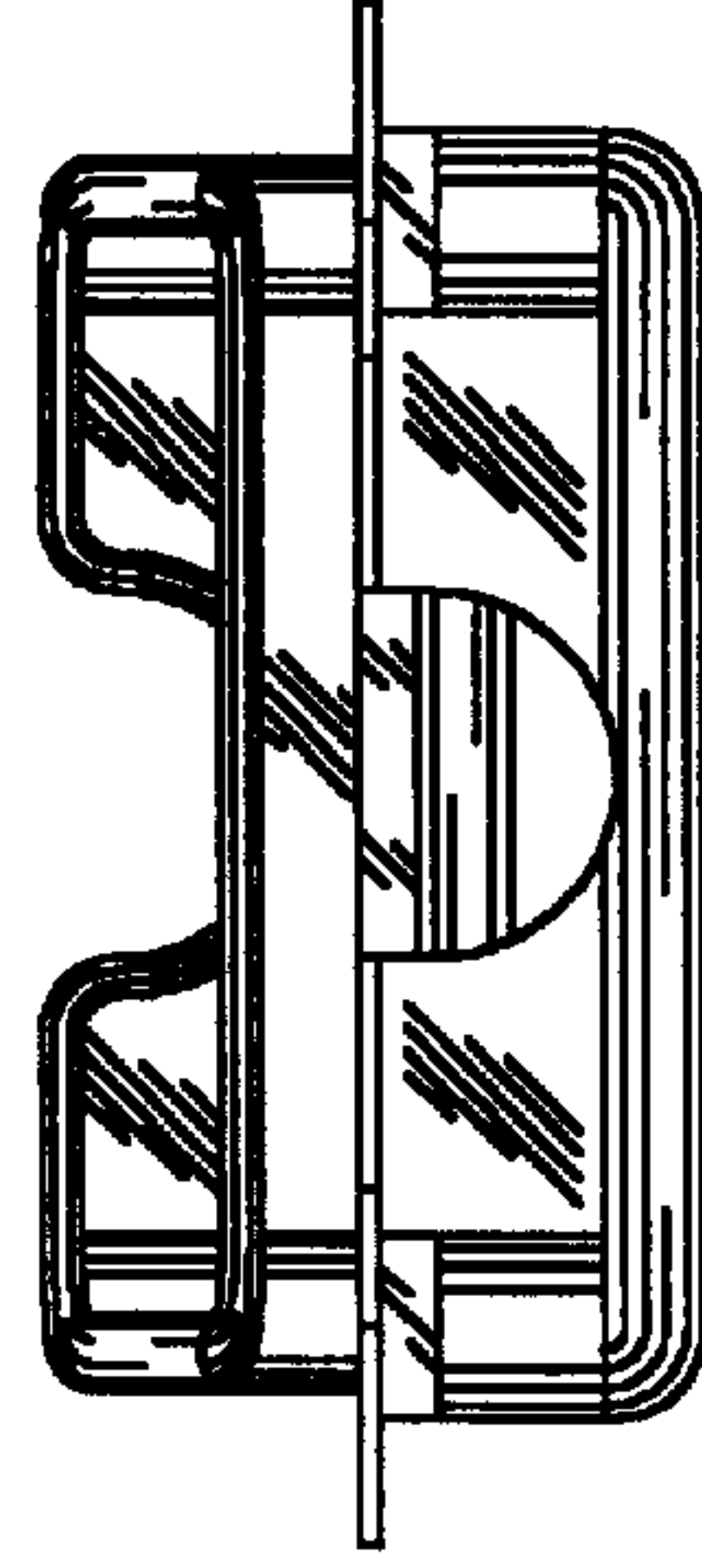

FIG. 6