



US00D401715S

United States Patent [19]

Whiteside et al.

[11] Patent Number: **Des. 401,715**

[45] Date of Patent: ****Nov. 24, 1998**

[54] **CREEPER**

[75] Inventors: **Kirt E. Whiteside**, Marion; **Terry L. Whiteside**, Delaware; **Robert E. Studer**, New Washington; **Keith R. Studer**, Shelby, all of Ohio

[73] Assignee: **Whiteside Mfg. Co.**, Delaware, Ohio

[**] Term: **14 Years**

[21] Appl. No.: **82,543**

[22] Filed: **Jan. 26, 1998**

[51] **LOC (6) Cl.** **12-02**

[52] **U.S. Cl.** **D34/23**

[58] **Field of Search** D34/12, 23; 280/32.6,
280/32.5, 79.11

[56] **References Cited**

U.S. PATENT DOCUMENTS

D. 230,971	3/1974	Shanklin	D14/3 M
D. 325,799	4/1992	Chen	D34/23
D. 330,619	10/1992	Gilbert et al.	D34/23
D. 351,707	10/1994	Pill	D34/23
5,174,592	12/1992	Pool	280/32.6
5,330,209	7/1994	Pool	280/32.6

OTHER PUBLICATIONS

Rel Products Incorporated advertisement, cover and 2 pages (undated).

P&B Mfg. Co. "Blue Max" advertisement, 1 page (1990).

Lisle "Creepers" advertisement, pp. 44 and 45 (undated).
E-Z Red "E-Z Rider" advertisement, 1 page (undated).
Wilmar Corporation "PT Performance Tool" product catalog, 2 pages (1996).
Petersen Automotive—Flambeau advertisement, 2 pages (undated).
United Auto Systems (Mack Tools) "Creepers" advertisement, 1 page (undated).
Whiteside Catalog advertisement, cover and 4 pages (1993).
Whiteside Catalog advertisement, cover and 3 pages (1995).

Primary Examiner—Kay H. Chin
Attorney, Agent, or Firm—Renner, Kenner, Greive, Bobak, Taylor & Weber

[57] **CLAIM**

The ornamental design for a creeper, as shown and described.

DESCRIPTION

FIG. 1 is a top, right side, left end perspective view of a creeper showing our new design;
FIG. 2 is a top plan view thereof;
FIG. 3 is a bottom plan view thereof;
FIG. 4 is a left side elevational view thereof, the right side being a mirror image of FIG. 4;
FIG. 5 is a right end elevational view thereof; and,
FIG. 6 is a left end elevational view thereof.

1 Claim, 4 Drawing Sheets

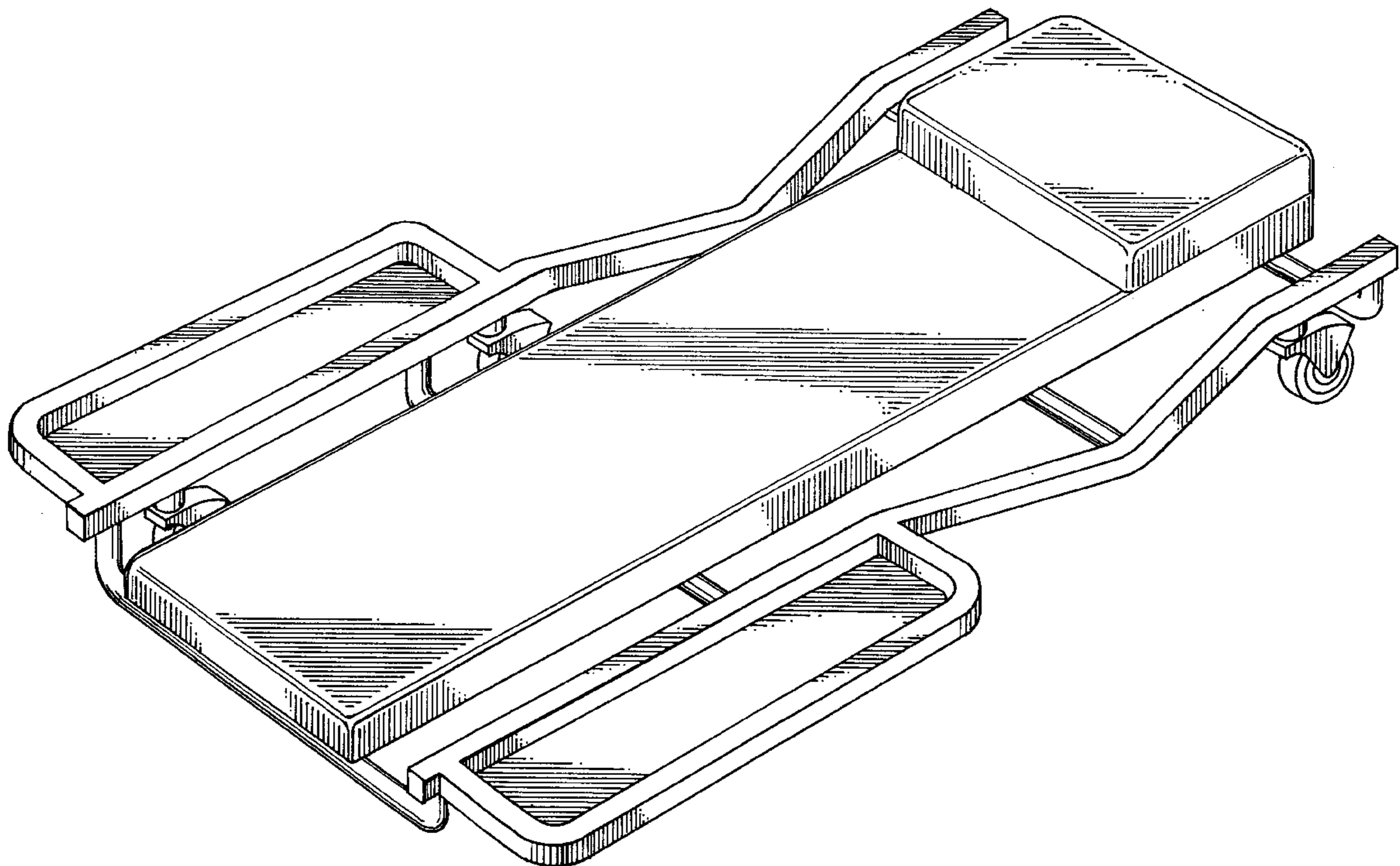

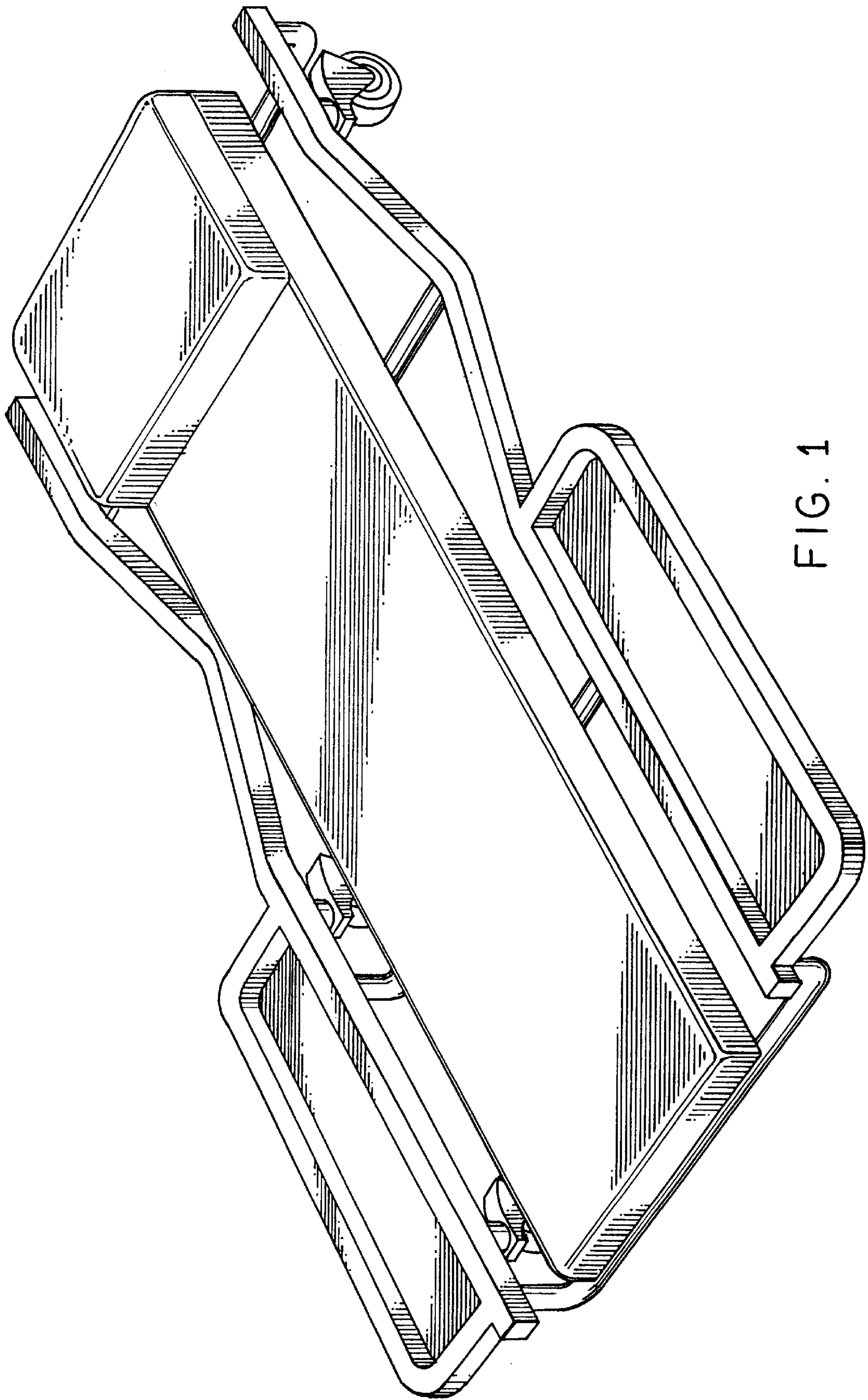

FIG. 1

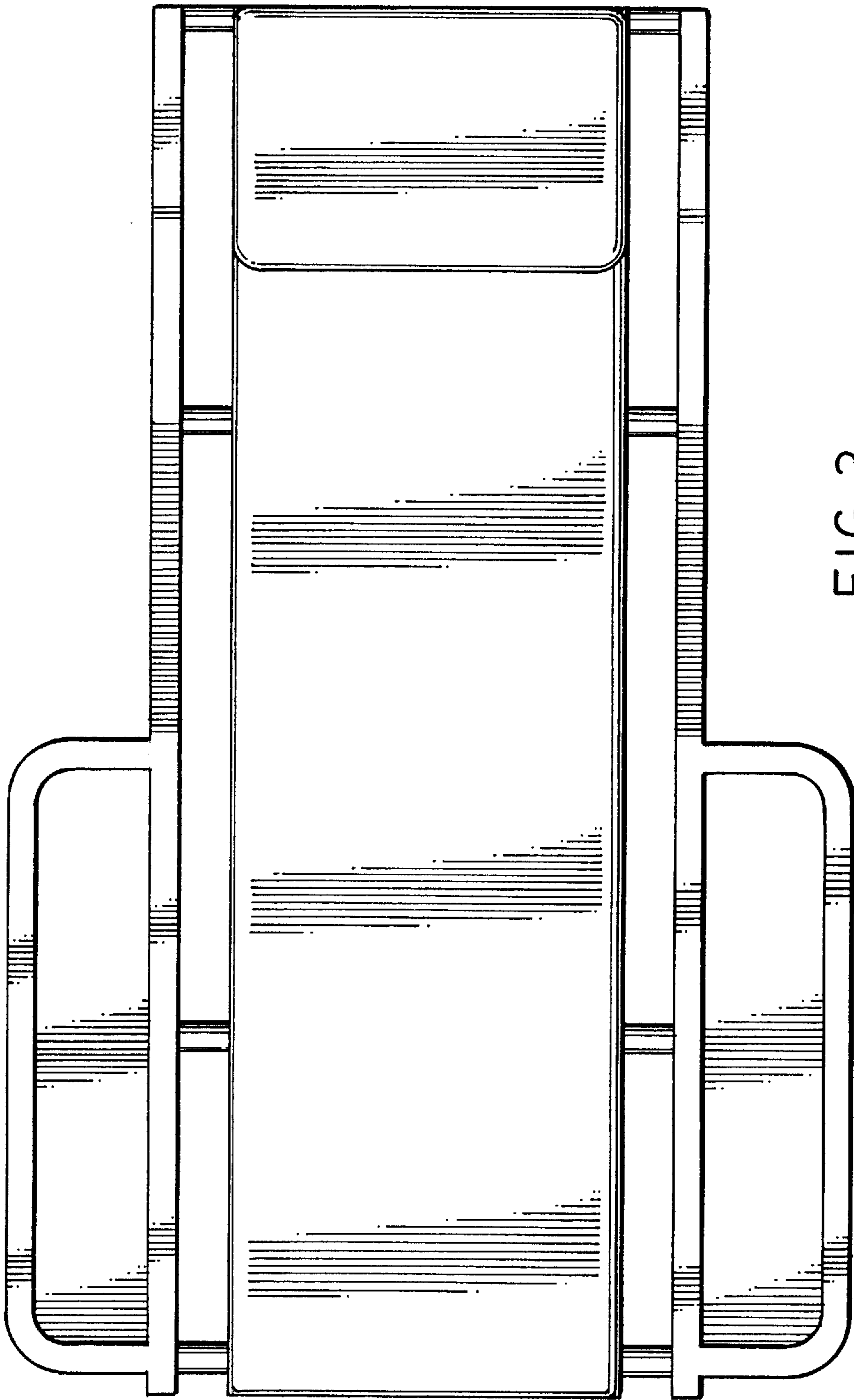

FIG. 2

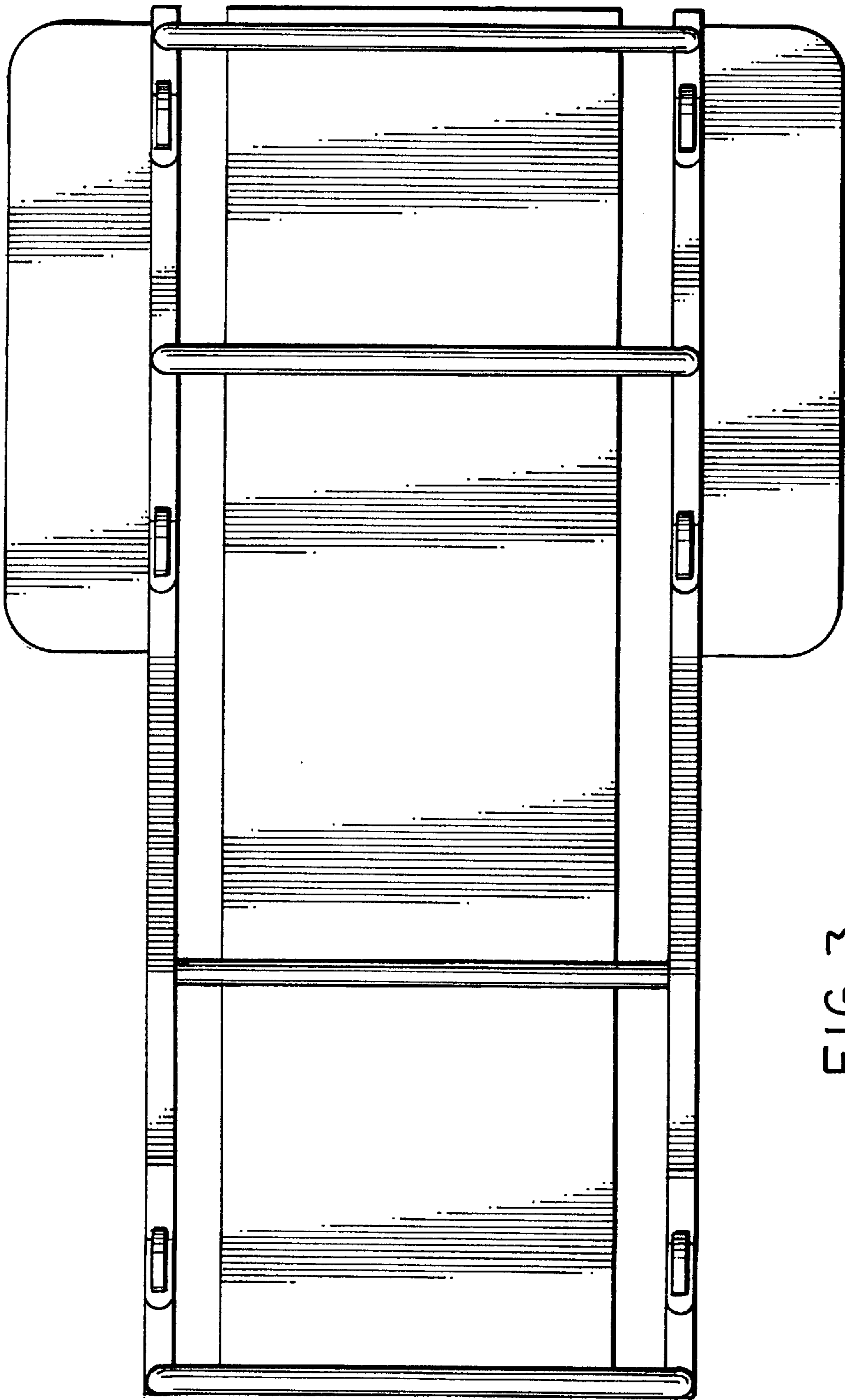

FIG. 3

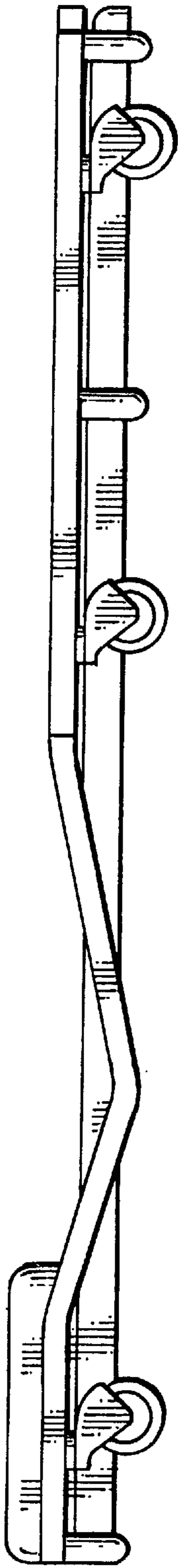

FIG. 4

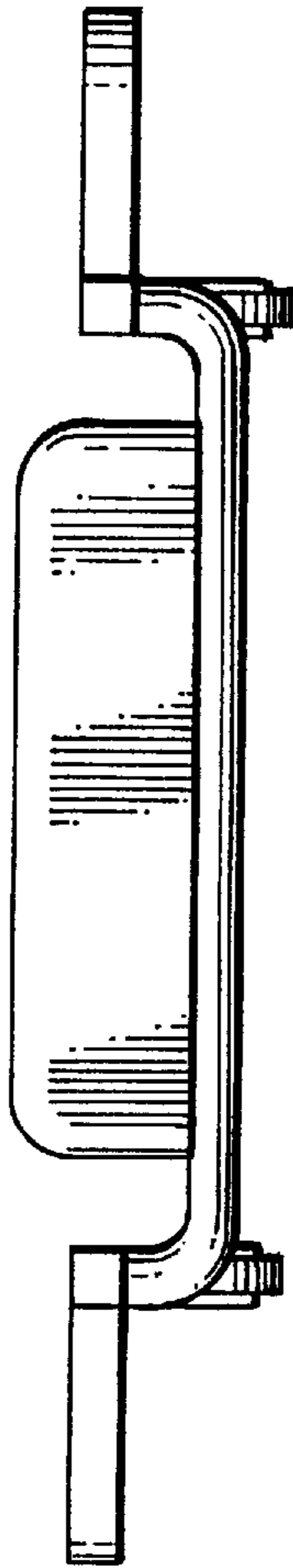

FIG. 5

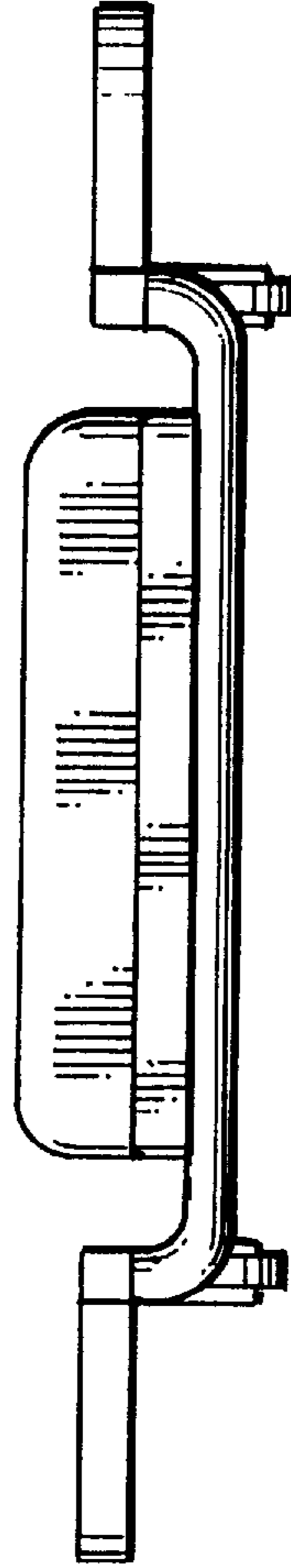

FIG. 6