



US00D401668S

United States Patent [19]
Kreizel

[11] **Patent Number: Des. 401,668**

[45] **Date of Patent: **Nov. 24, 1998**

[54] **WATERING CAN**

[75] Inventor: **James Kreizel**, Hewlett, N.Y.

[73] Assignee: **Dynamic Design, Inc.**, East Elmhurst, N.Y.

[**] Term: **14 Years**

[21] Appl. No.: **79,813**

[22] Filed: **Nov. 19, 1997**

- D. 266,018 8/1982 Dilyard .
- D. 266,450 10/1982 Swett et al. .
- D. 279,310 6/1985 Murphy .
- D. 323,544 1/1992 Davis D23/212
- D. 357,729 4/1995 Boyd .
- D. 375,139 10/1996 Thorp D23/212
- 1,932,125 10/1933 Woodward .
- 3,648,933 3/1972 Grotz .
- 3,918,582 11/1975 Wallace .
- 4,030,664 6/1977 Tisbo et al. .

Related U.S. Application Data

[63] Continuation-in-part of Ser. No. 858,276, May 19, 1997.

[51] **LOC (6) Cl. 23-01**

[52] **U.S. Cl. D23/212**

[58] **Field of Search D23/200, 211,**
D23/212; 222/565, 572, 470; 239/375,
376, 377, 378

Primary Examiner—Alan P. Douglas
Assistant Examiner—Robin V. Taylor
Attorney, Agent, or Firm—Dilworth & Barrese

[57] **CLAIM**

The ornamental design for a watering can, as shown and described.

DESCRIPTION

FIG. 1 is a perspective view of a watering can, constructed in accordance with the presently disclosed design; FIG. 2 is a top plan view thereof, shown in a different scale for ease of illustration; FIG. 3 is a side elevation view of FIG. 2, the opposite side being a mirror image thereto; FIG. 4 is a front elevation view thereof; FIG. 5 is a rear elevation view thereof; and, FIG. 6 is a bottom plan view thereof. The dotted line showing of a watering spout is for illustrative purposes only and forms no part of the claimed design.

[56] **References Cited**

U.S. PATENT DOCUMENTS

- 38,545 5/1863 Bamber .
- D. 169,700 5/1953 Rowe D23/212
- D. 175,084 7/1955 Locke et al. .
- D. 184,893 4/1959 Reinecke .
- D. 219,368 12/1970 Campbell D23/212
- D. 229,056 11/1973 Grotz .
- D. 240,129 6/1976 Grotz .
- D. 241,032 8/1976 Burke et al. .

1 Claim, 4 Drawing Sheets

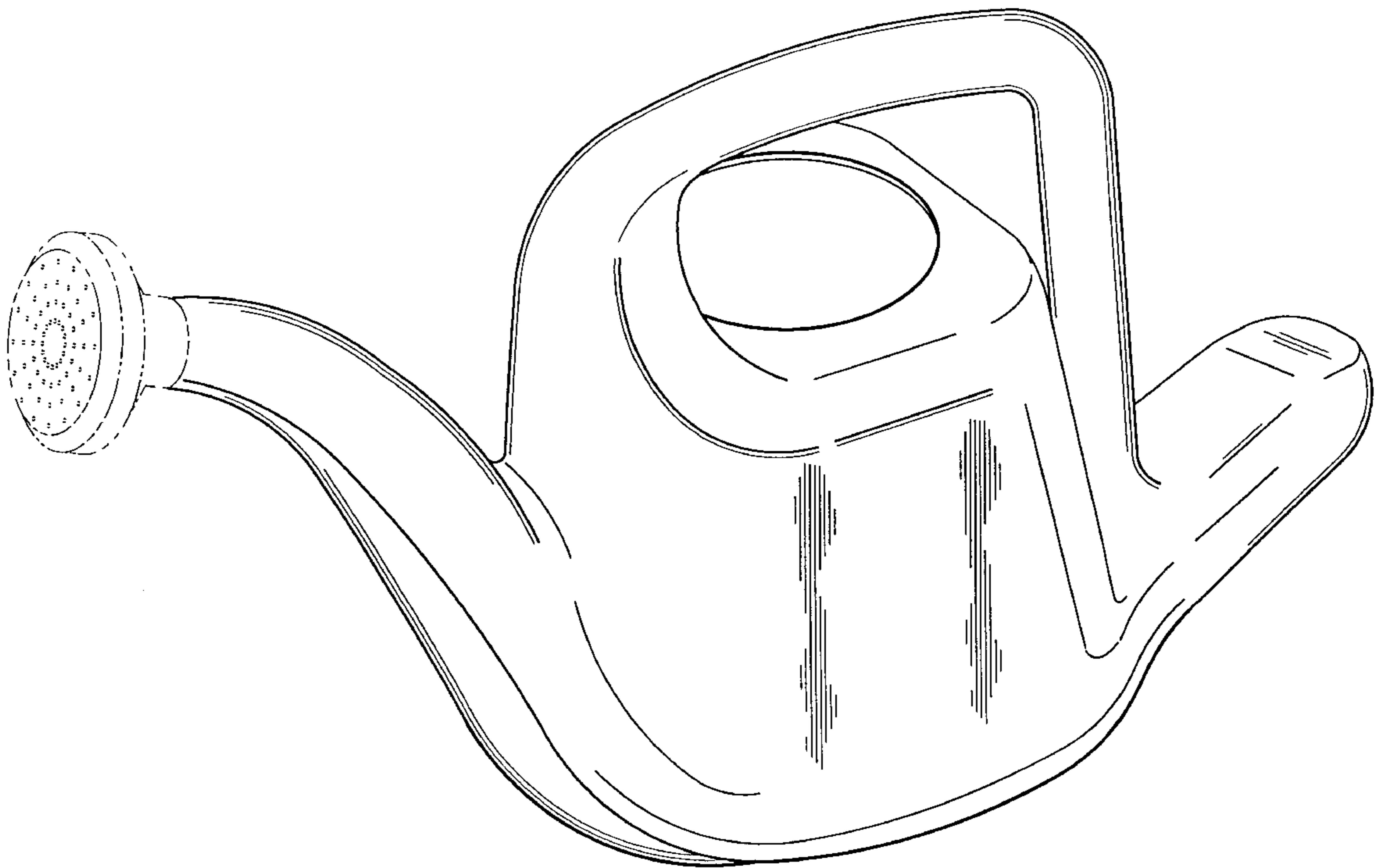

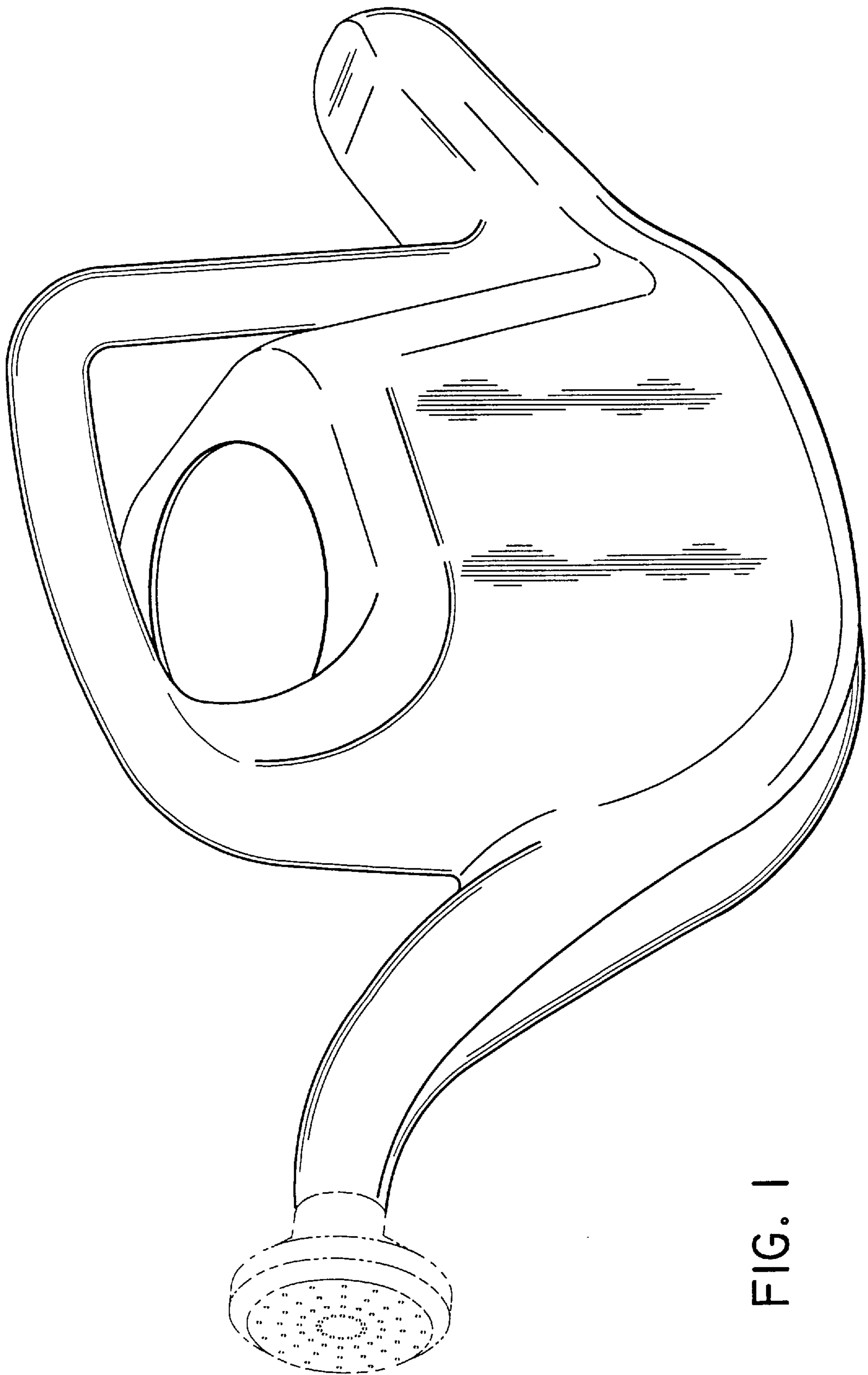

FIG. 1

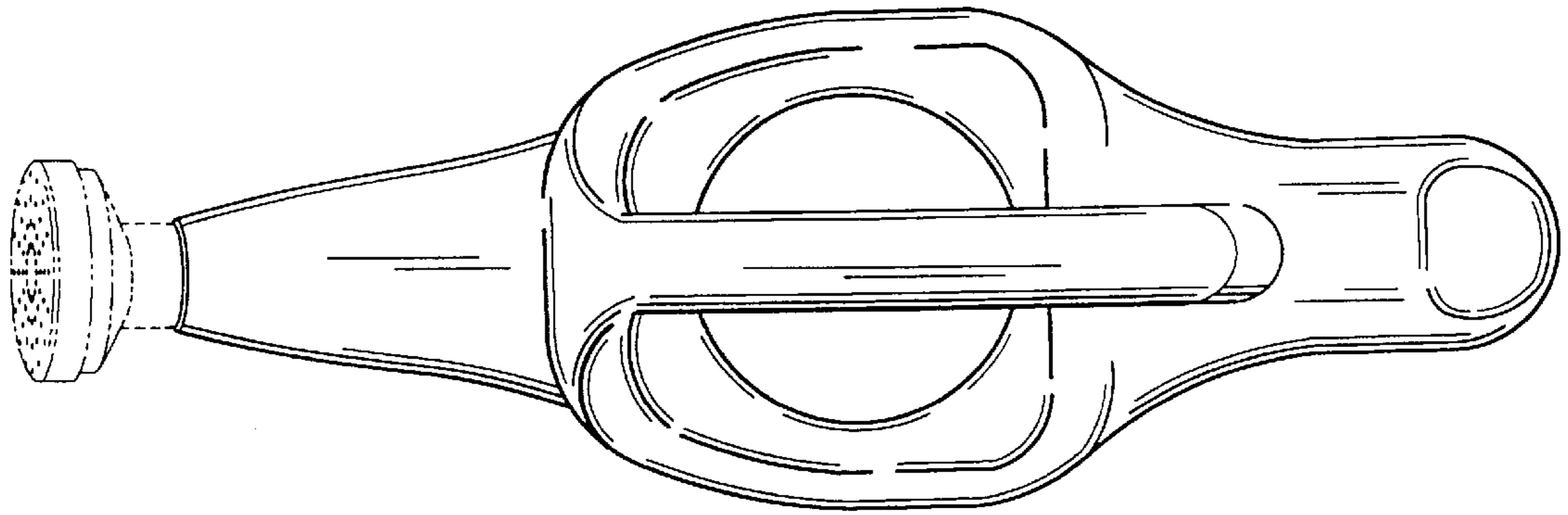

FIG. 2

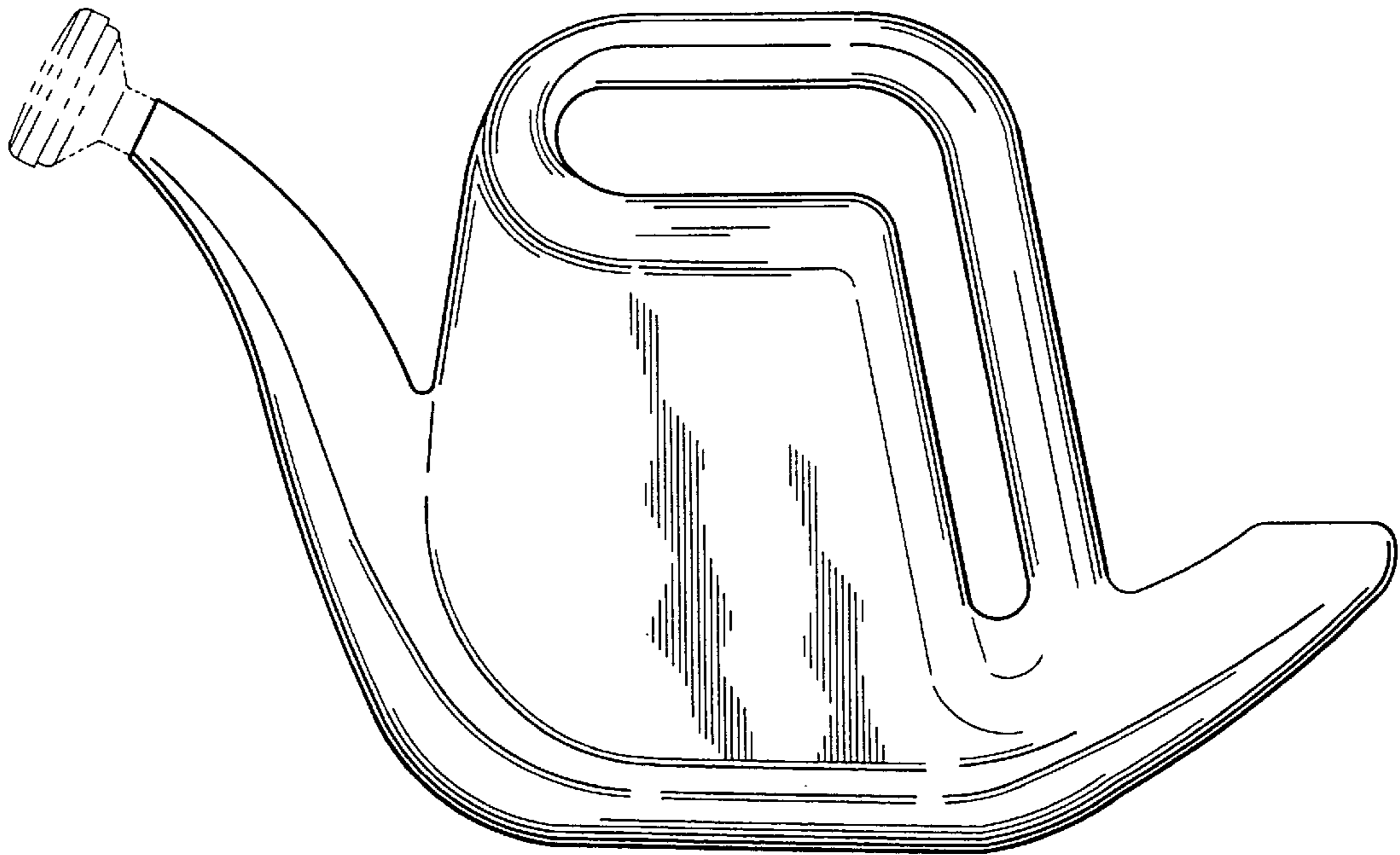

FIG. 3

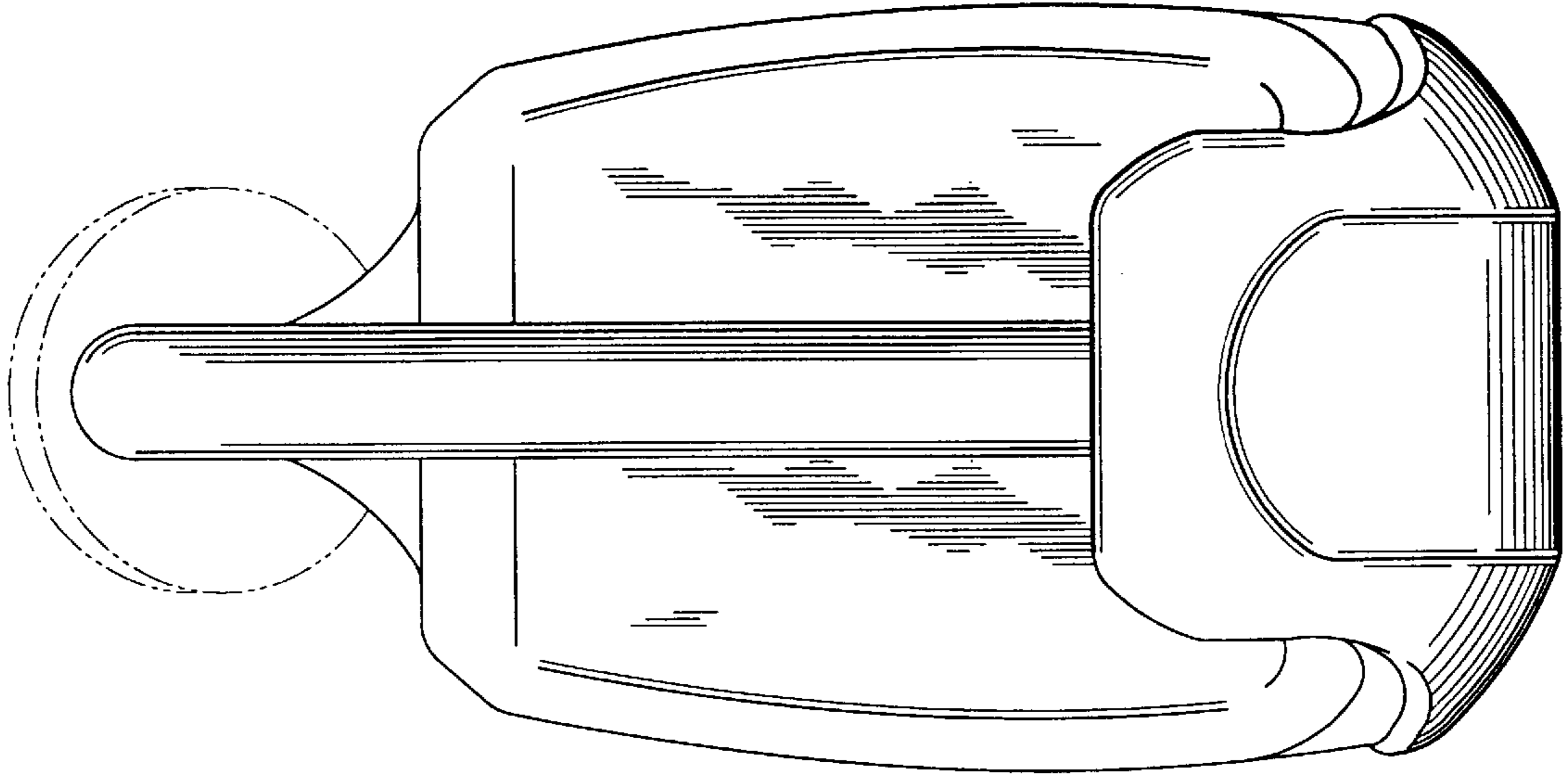

FIG. 5

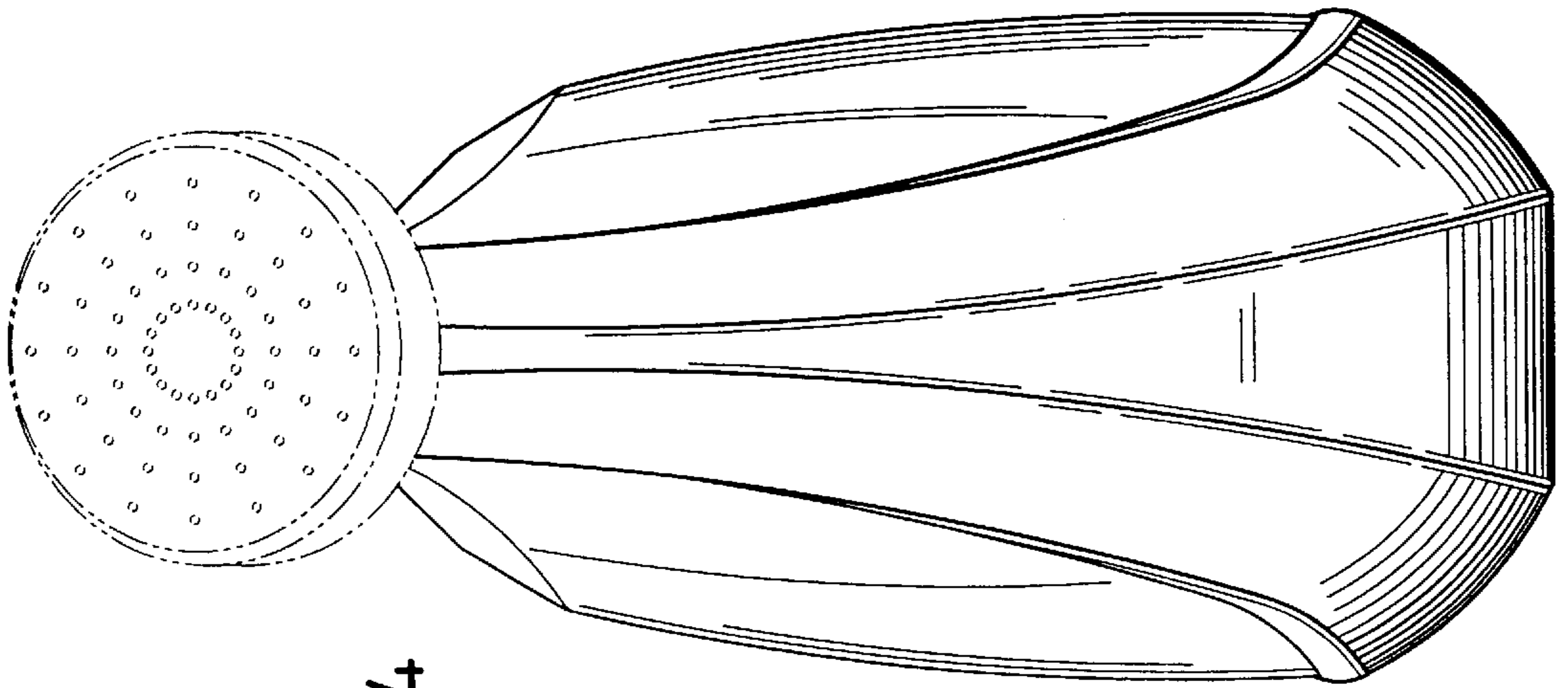

FIG. 4

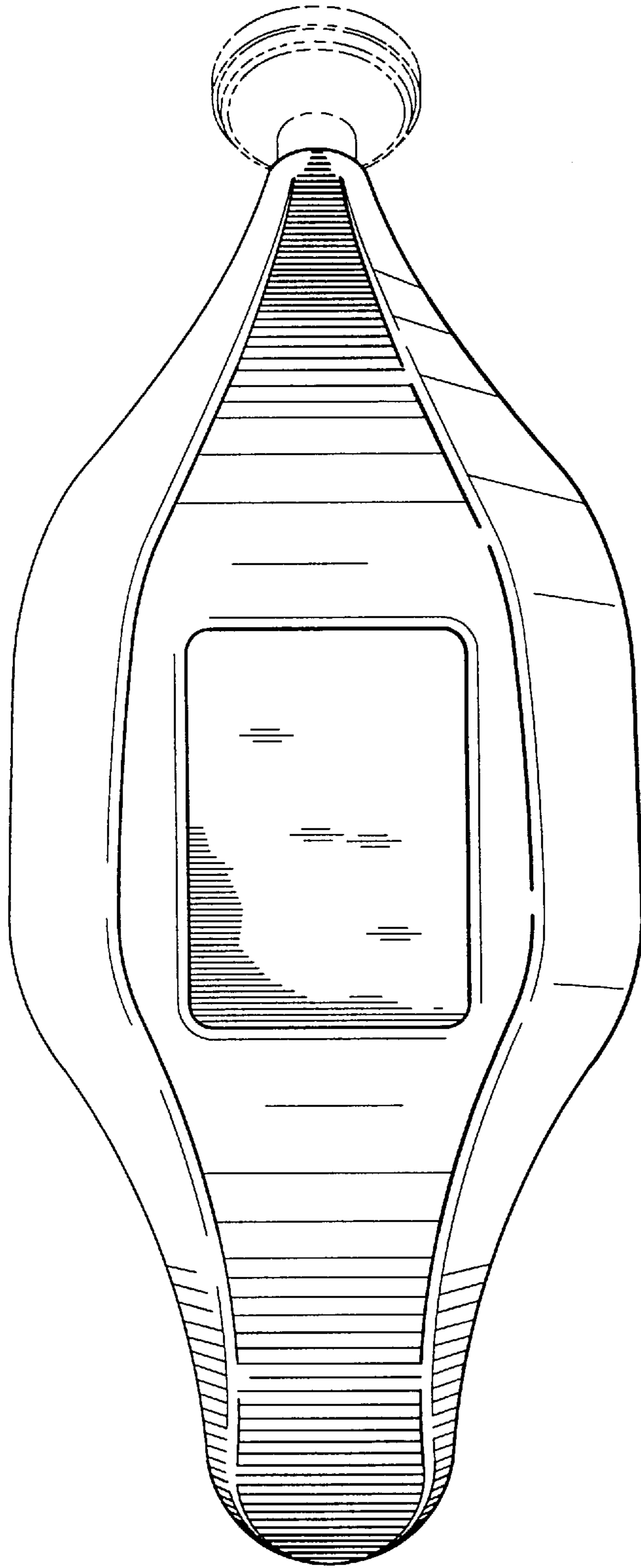

FIG. 6