



US00D401600S

# United States Patent [19]

Byerly et al.

[11] Patent Number: **Des. 401,600**

[45] Date of Patent: **\*\*Nov. 24, 1998**

[54] **LIQUID DISPENSING DEVICE**

[75] Inventors: **David J. Byerly**, Lawrenceville;  
**Charles P. Ganzer**, Cumming, both of  
Ga.; **Thomas C. Jenkins**, Amherst,  
Ohio

[73] Assignee: **Nordson Corporation**, Westlake, Ohio

[\*\*] Term: **14 Years**

[21] Appl. No.: **78,994**

[22] Filed: **Nov. 3, 1997**

[51] **LOC (6) Cl.** ..... **15-09**

[52] **U.S. Cl.** ..... **D15/144.2**

[58] **Field of Search** ..... D15/135, 144,  
D15/144.1, 144.2; 219/49, 420-426, 430,  
431, 440, 460; 222/1.46 HE, 49, 149, 504,  
487; 239/11, 586, 135

[56] **References Cited**

**U.S. PATENT DOCUMENTS**

Re. 27,865	1/1974	Baker et al.	.....	222/504
D. 281,168	10/1985	Scholl et al.	.....	D15/144
D. 354,295	1/1995	Walsh et al.	.....	D15/144.2
D. 354,296	1/1995	Walsh et al.	.....	D15/144.2
D. 365,830	1/1996	Hubbard et al.	.....	D15/144.2

(List continued on next page.)

**FOREIGN PATENT DOCUMENTS**

0790080	8/1997	European Pat. Off.	.
4313161	10/1993	Germany	.

**OTHER PUBLICATIONS**

Vertriebs-und Entwicklungsgesellschaft mbH,  
*UES®Klebertechnik, Beschreibung der Modulserie H300*,  
Leaflet (undated), 4 pages.

Nordson Corporation, *H-201 Zero Cavity Gun, Product  
Information*, 1985, 2 pages.

Nordson Corporation, *Drop-In Cartridge Hot Melt Gun  
Model AD-24*, Marketing Communications Bulletin, 1973,  
2 pages.

Nordson Corporation, *H-200 Series Modular Hot Melt  
Guns, Product Information*, 1981, 2 pages.

Mercer Corporation, *Low Profile Heads featuring Quick-  
change "Repairable" Screw-in Cartridges*, 1982, 7 pages.

Nordson Corporation, *Module, H2000, Adjustable*, 272282,  
Drawing, 1980.

*Primary Examiner*—Antoine Duval Davis  
*Attorney, Agent, or Firm*—Wood, Herron & Evans, L.L.P.

[57] **CLAIM**

The ornamental design for a liquid dispensing device, as  
shown and described.

**DESCRIPTION**

FIG. 1 is a front perspective view of a first embodiment of  
the liquid dispensing device;

FIG. 2 is a front elevational view of the first embodiment;

FIG. 3 is a right side view of the first embodiment, the left  
side being a mirror image thereof;

FIG. 4 is a rear view of the first embodiment;

FIG. 5 is a top view of the first embodiment;

FIG. 6 is a bottom view of the first embodiment;

FIG. 7 is a front perspective view of a second embodiment  
of the liquid dispensing device;

FIG. 8 is a front elevational view of a second embodiment;

FIG. 9 is a right side view of the second embodiment, the left  
side being a mirror image thereof;

FIG. 10 is a rear view of the second embodiment;

FIG. 11 is a rear view of the second embodiment;

FIG. 12 is a bottom view of the second embodiment;

FIG. 13 is a front perspective view of a third embodiment of  
the liquid dispensing device;

FIG. 14 is a front elevational view of the third embodiment;

FIG. 15 is a top view of the third embodiment; and,

FIG. 16 is a bottom view of the third embodiment.

The right, left and rear views of the third embodiment are the  
same as shown and described for FIGS. 3 and 4. Finally, the  
various design features of the three embodiments may be  
interchanged with one another.

The elements shown in broken lines are for environmental  
purposes and relate to elements which do not form part of  
the claimed invention.

**1 Claim, 3 Drawing Sheets**

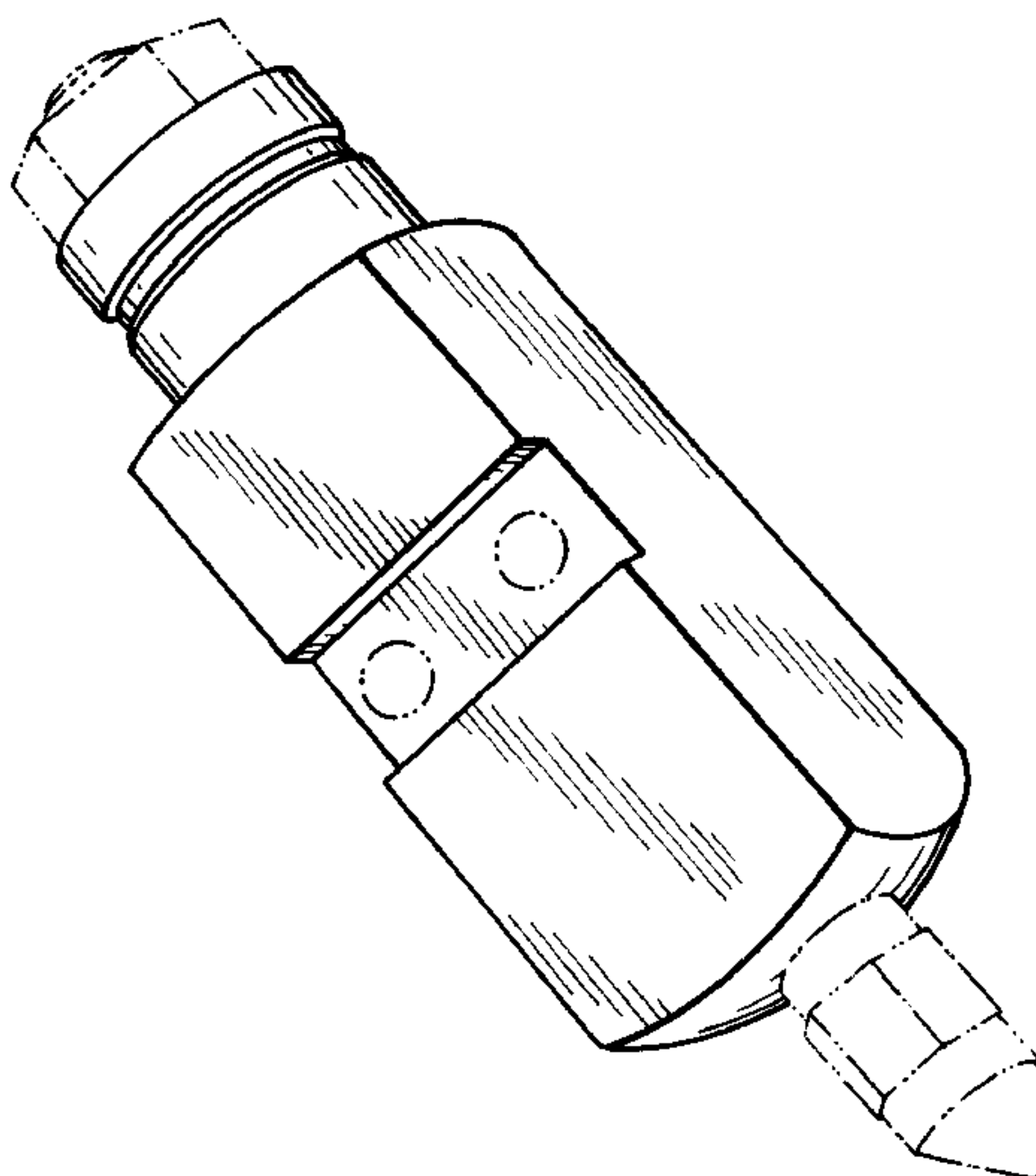

# Des. 401,600

Page 2

---

U.S. PATENT DOCUMENTS			
3,840,158	10/1974	Baker et al. ....	222/487
4,066,188	1/1978	Scholl et al. ....	222/146
4,295,573	10/1981	Terry et al. ....	215/348
4,334,637	6/1982	Baker et al. ....	222/146
4,465,212	8/1984	Boone .....	222/504
4,579,255	4/1986	Frates et al. ....	222/149
4,801,051	1/1989	Lewis et al. ....	222/309
4,989,792	2/1991	Claassen .....	239/586
5,207,352	5/1993	Porter et al. ....	222/1
5,277,344	1/1994	Jenkins .....	222/504
5,292,068	3/1994	Rateman et al. ....	239/11
5,447,254	9/1995	Hoover et al. ....	222/1
5,598,974	2/1997	Lewis et al. ....	239/135

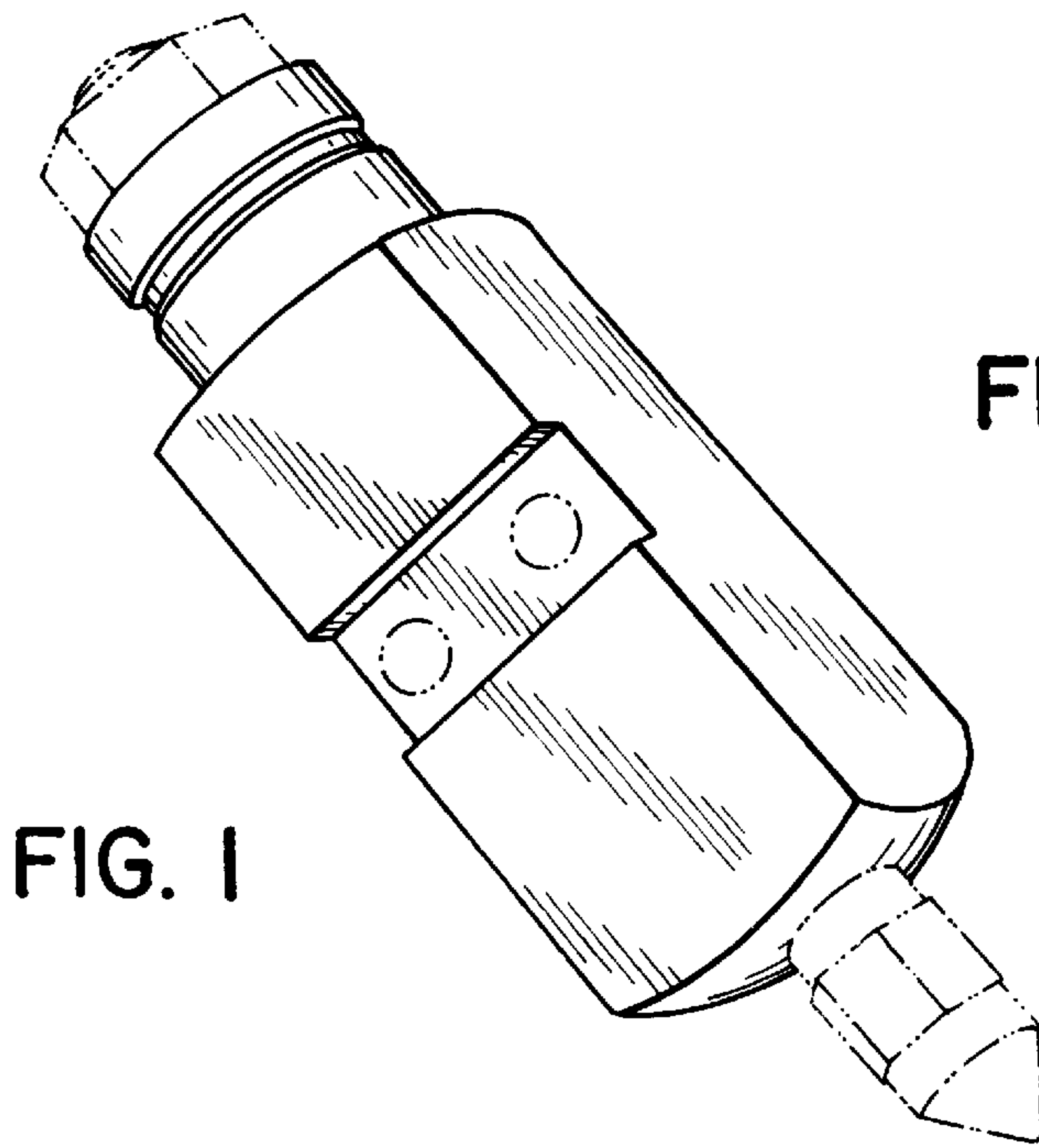

FIG. 1

FIG. 2

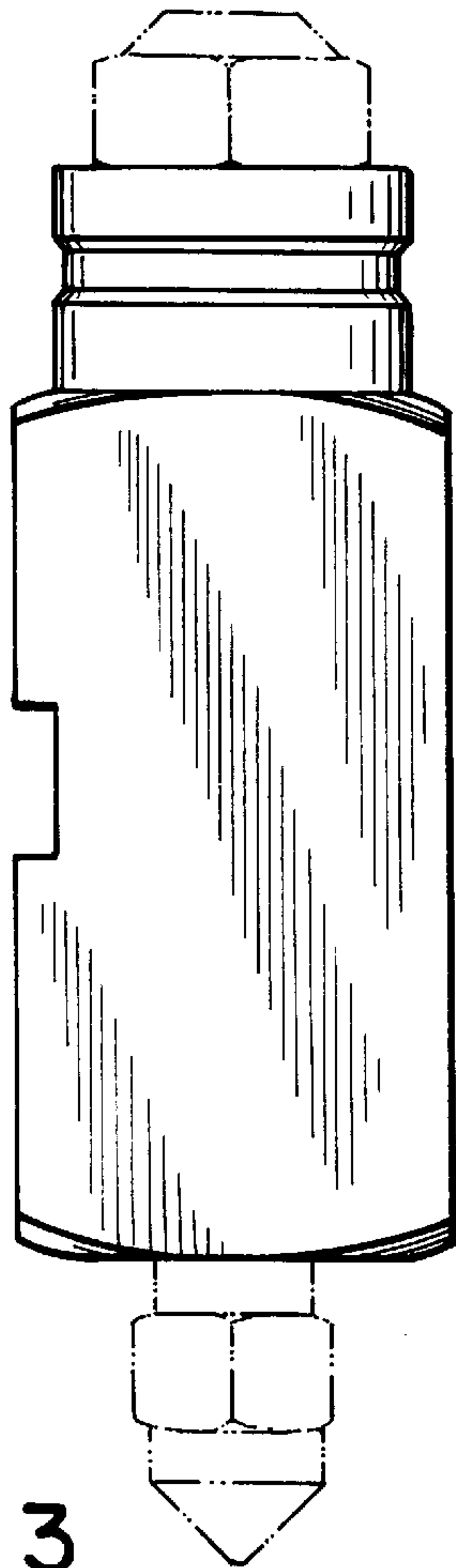
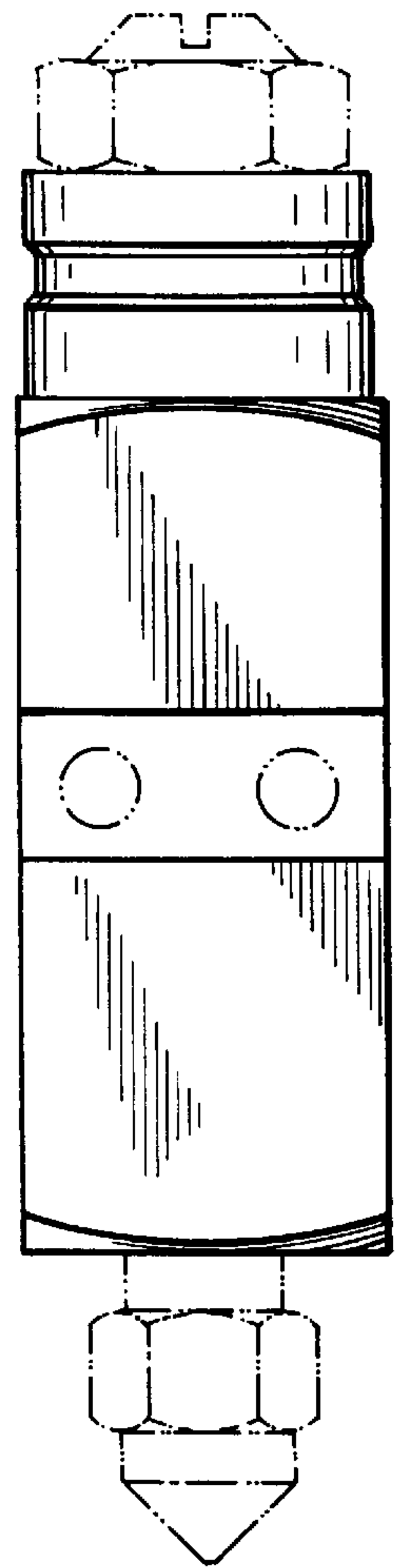

FIG. 3

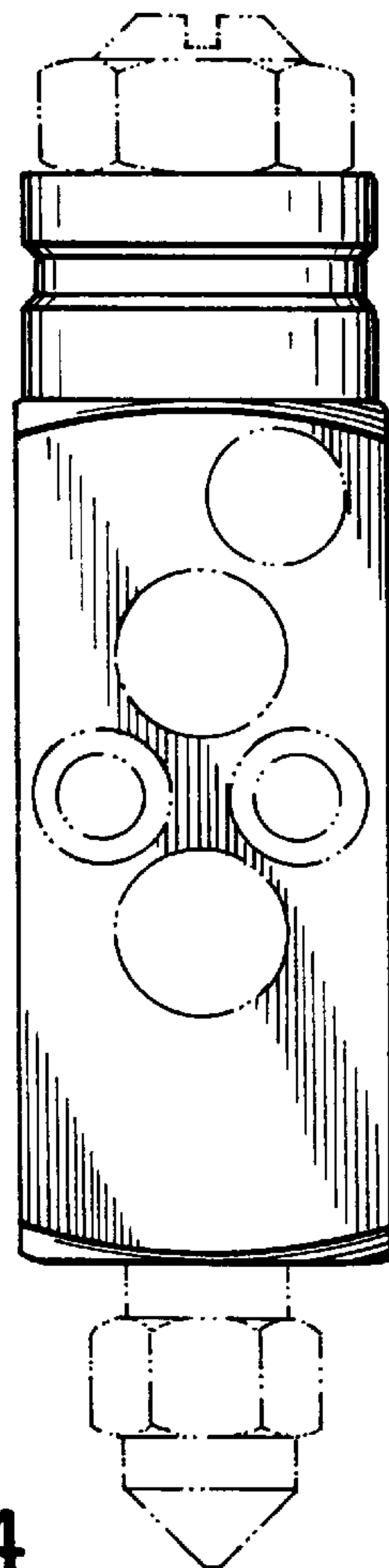

FIG. 4

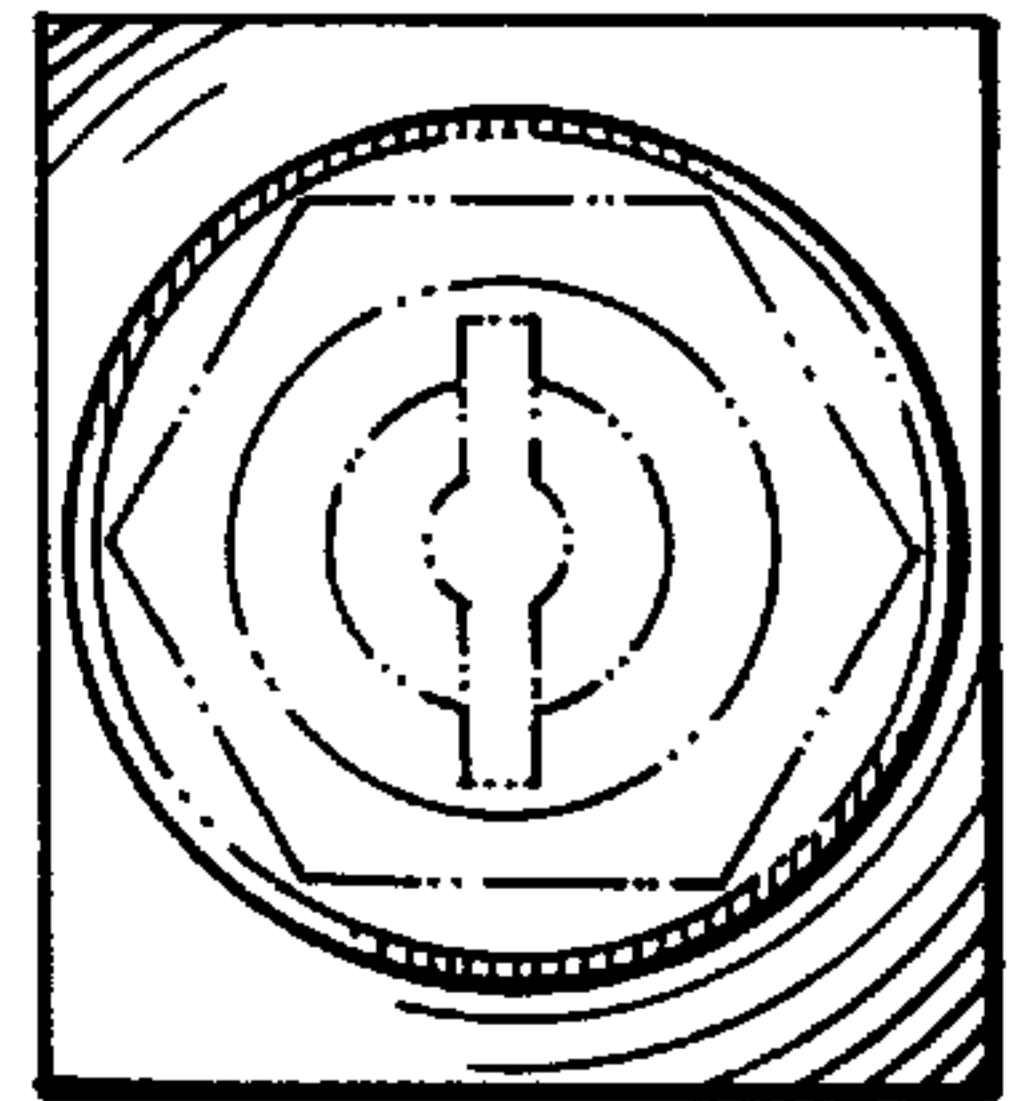

FIG. 5

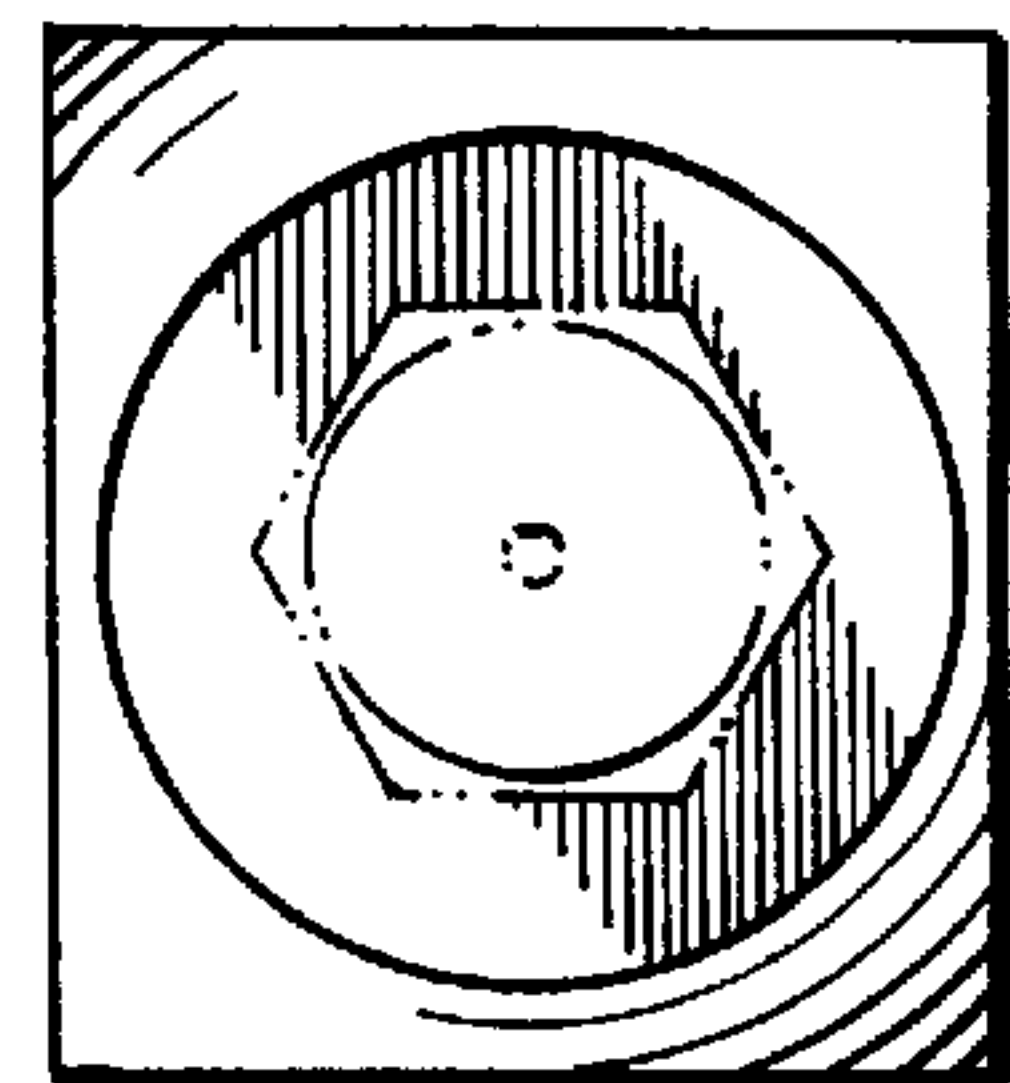

FIG. 6



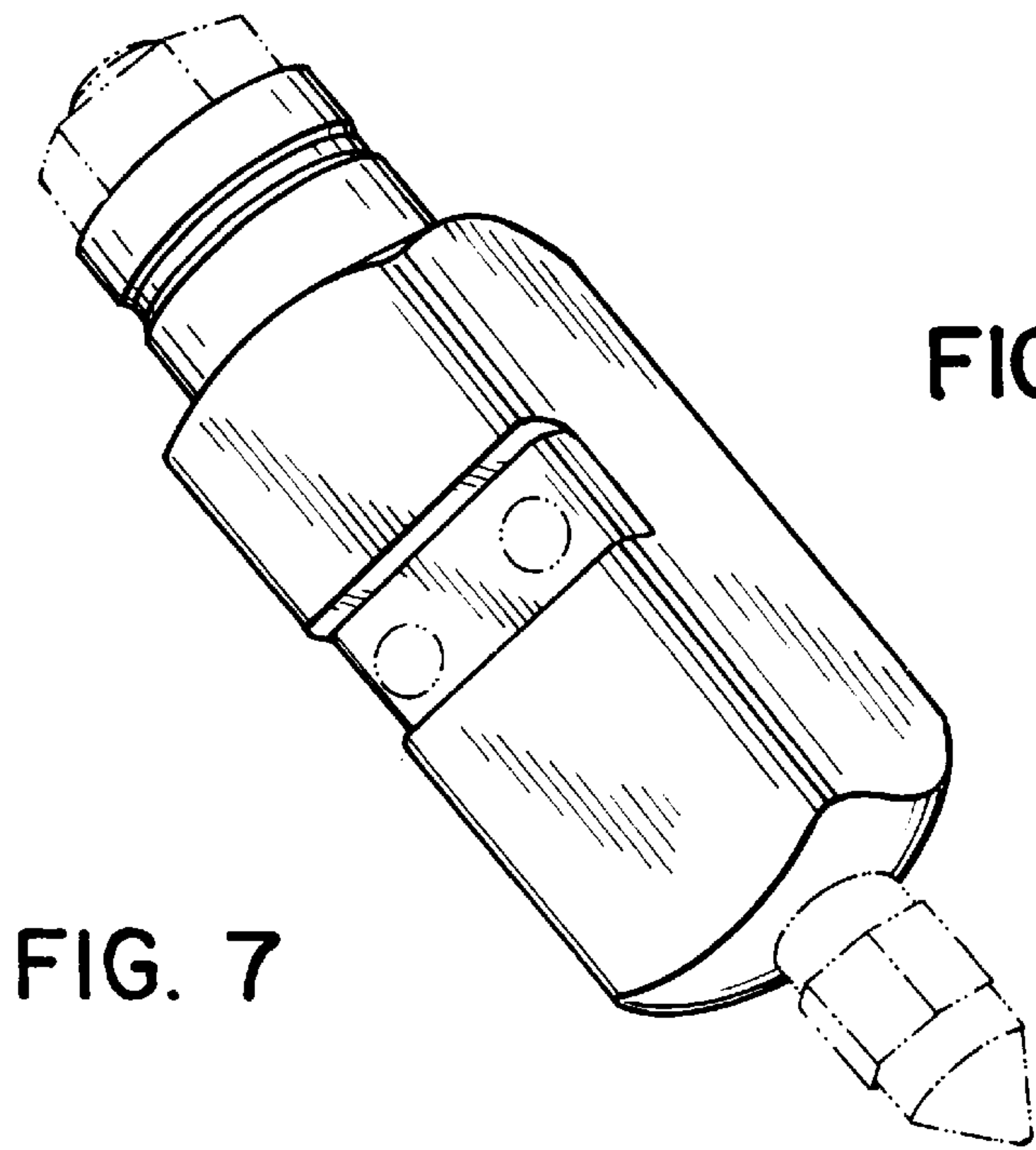

FIG. 7

FIG. 8

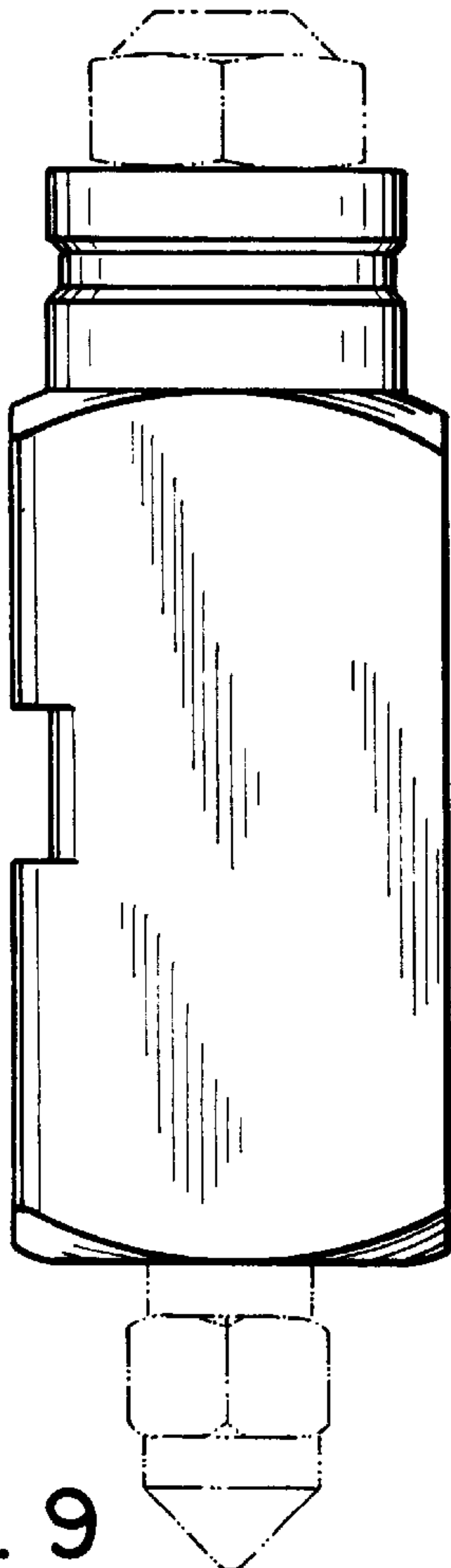
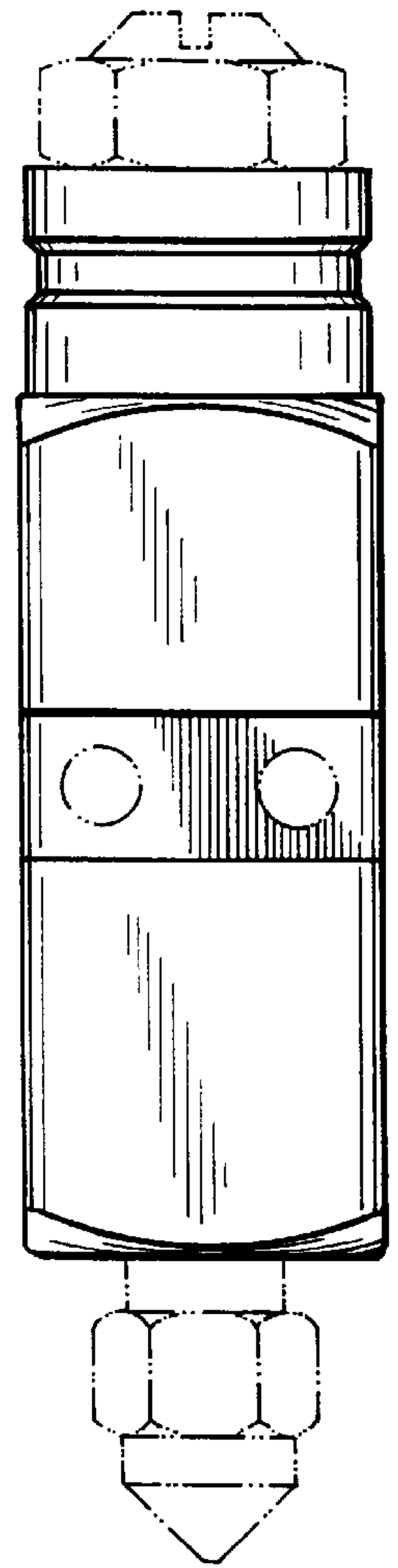

FIG. 9

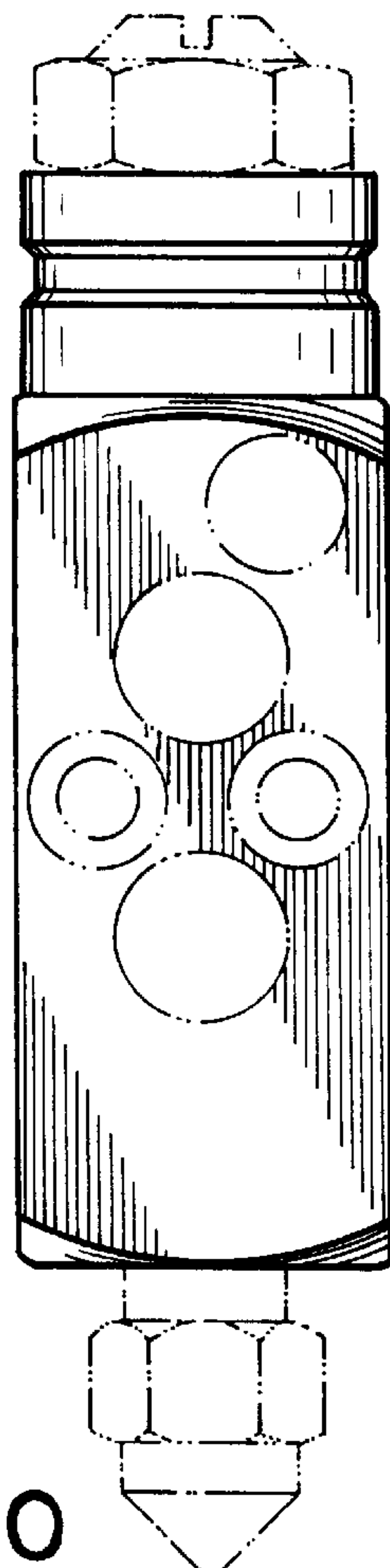

FIG. 10

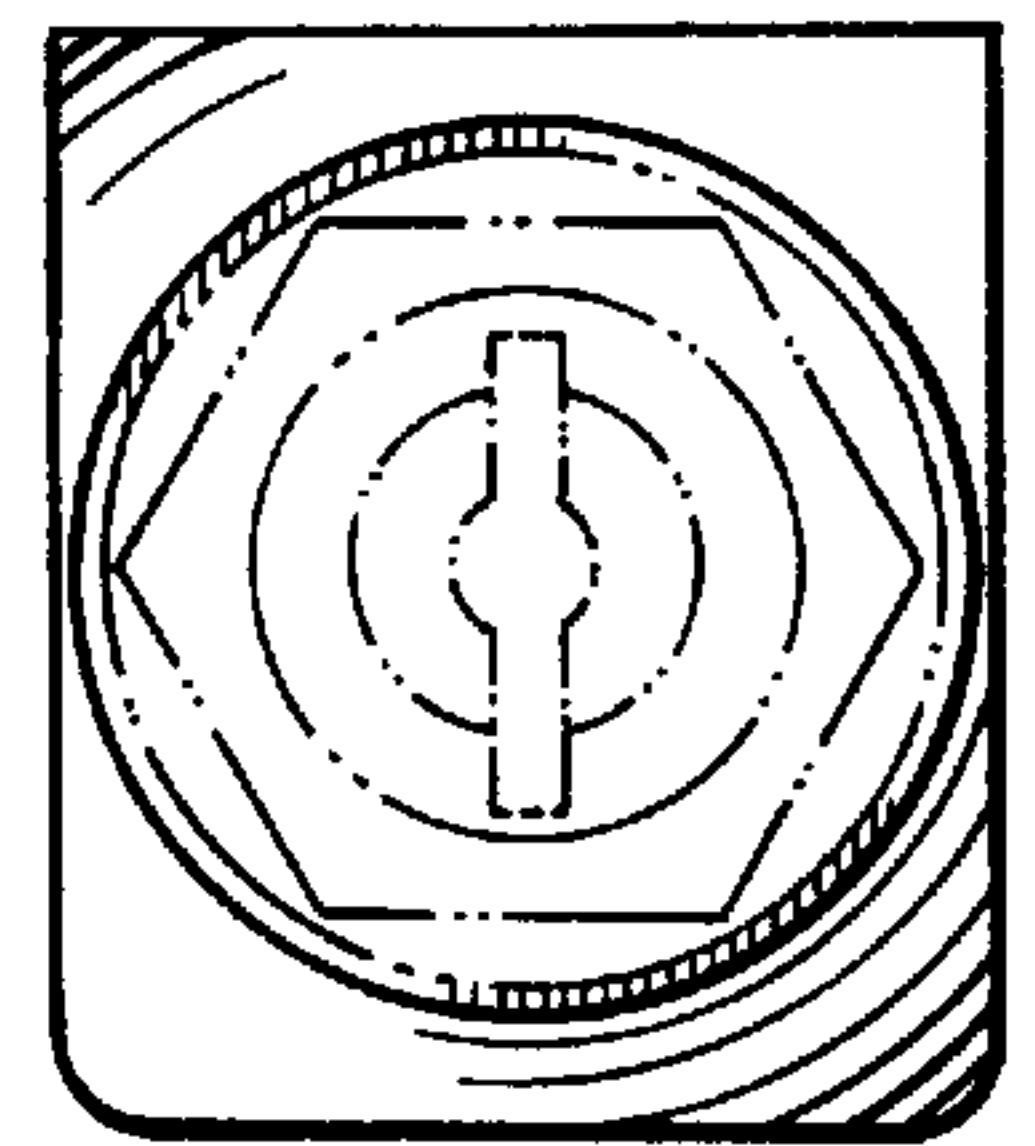

FIG. 11

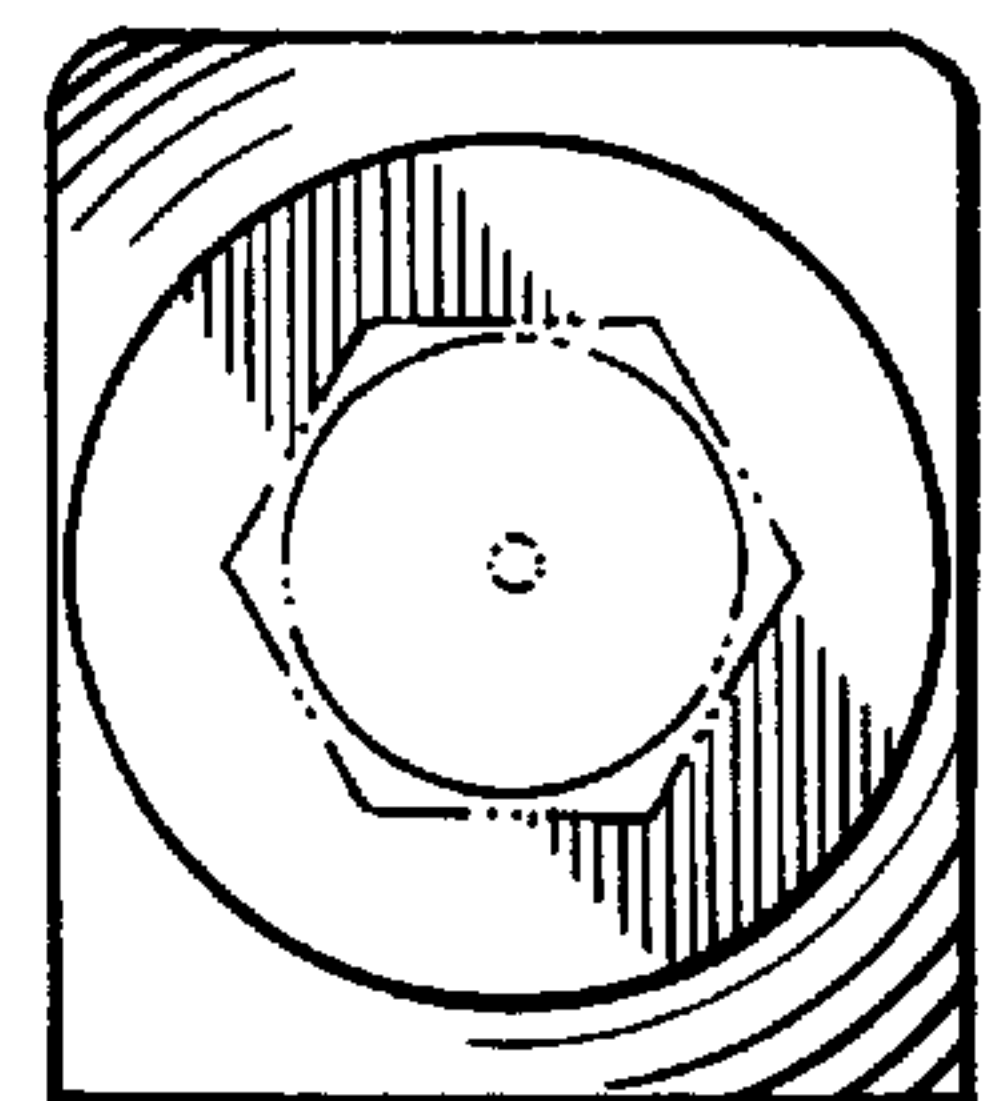

FIG. 12

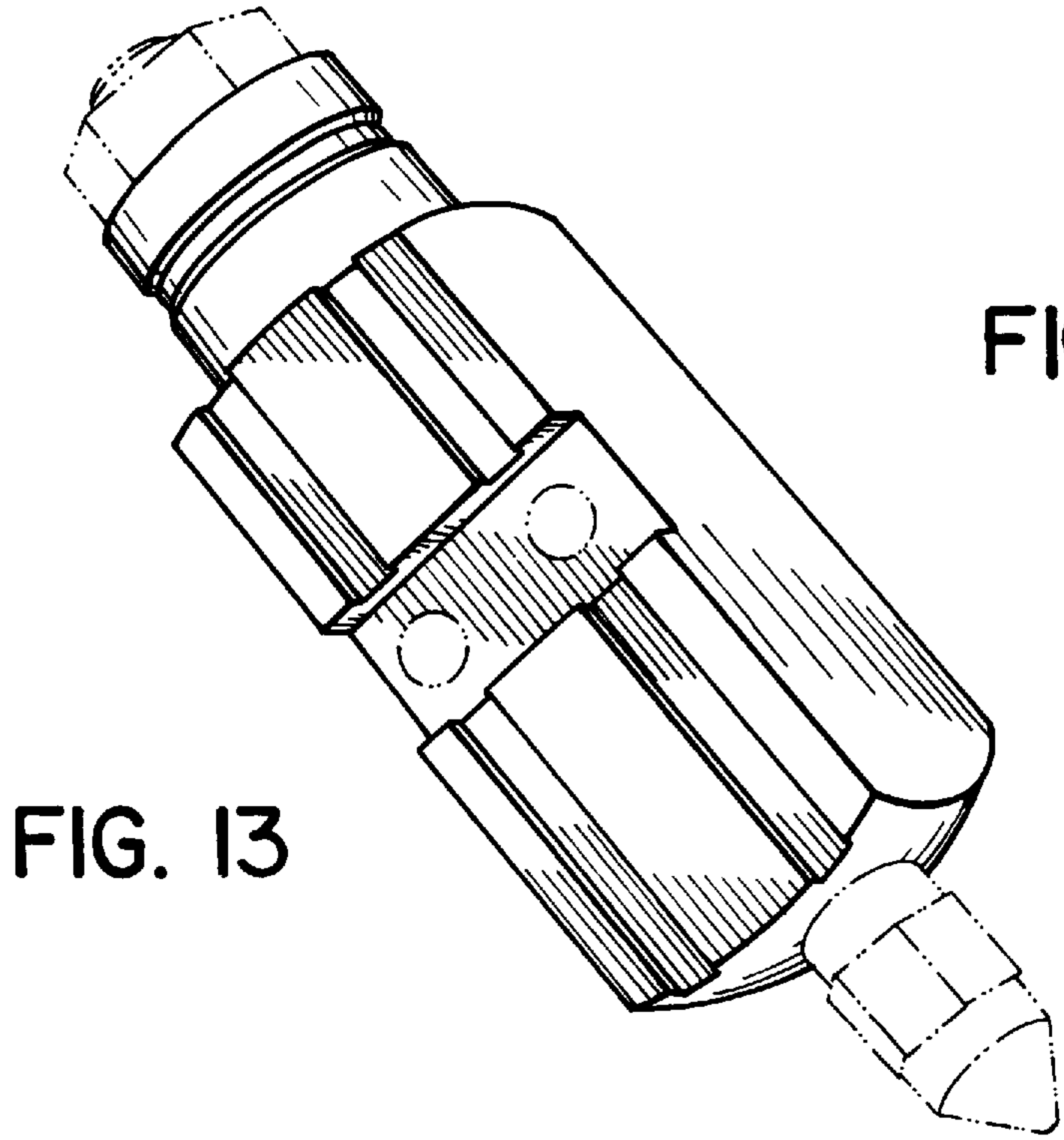

FIG. 14

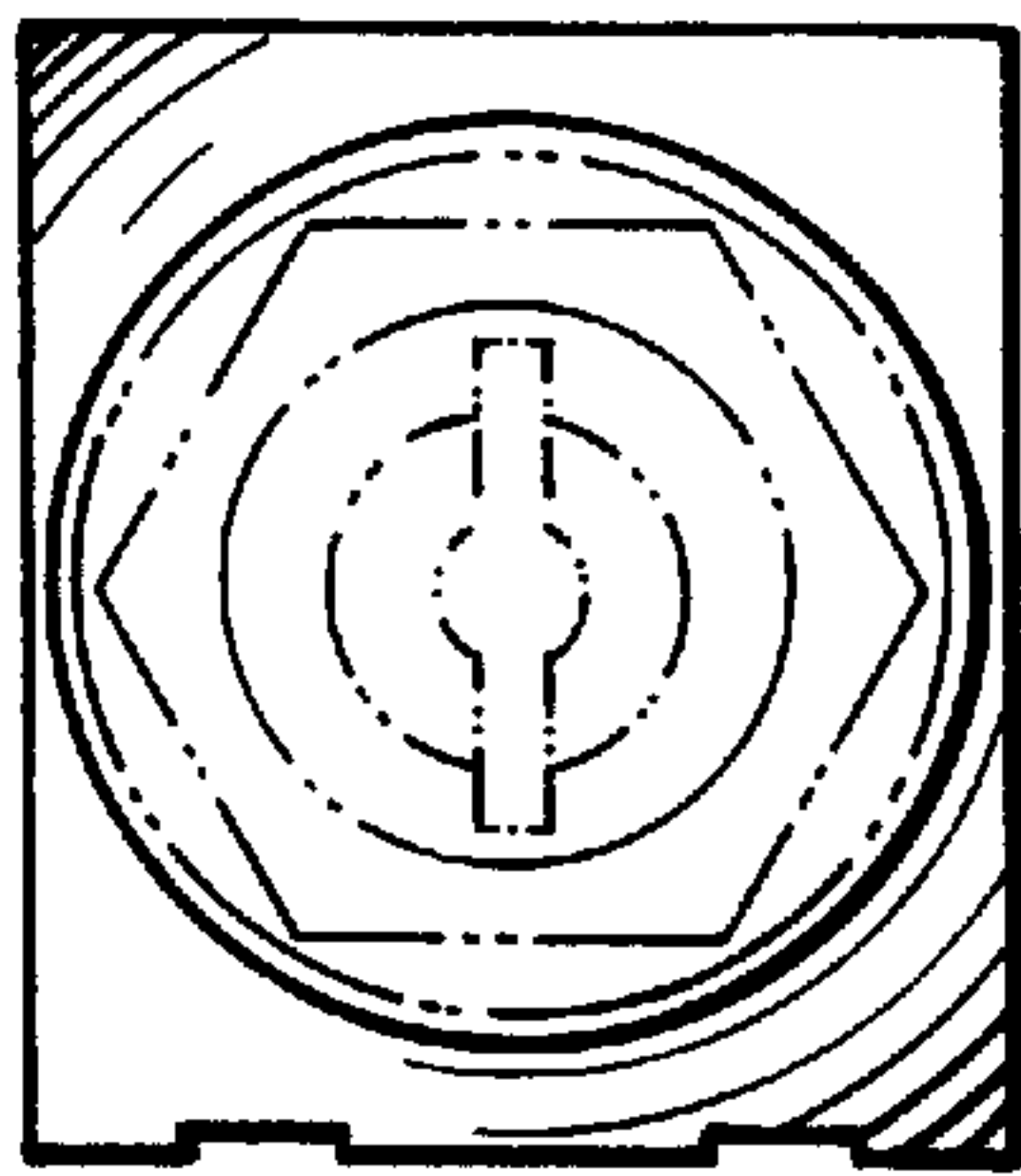
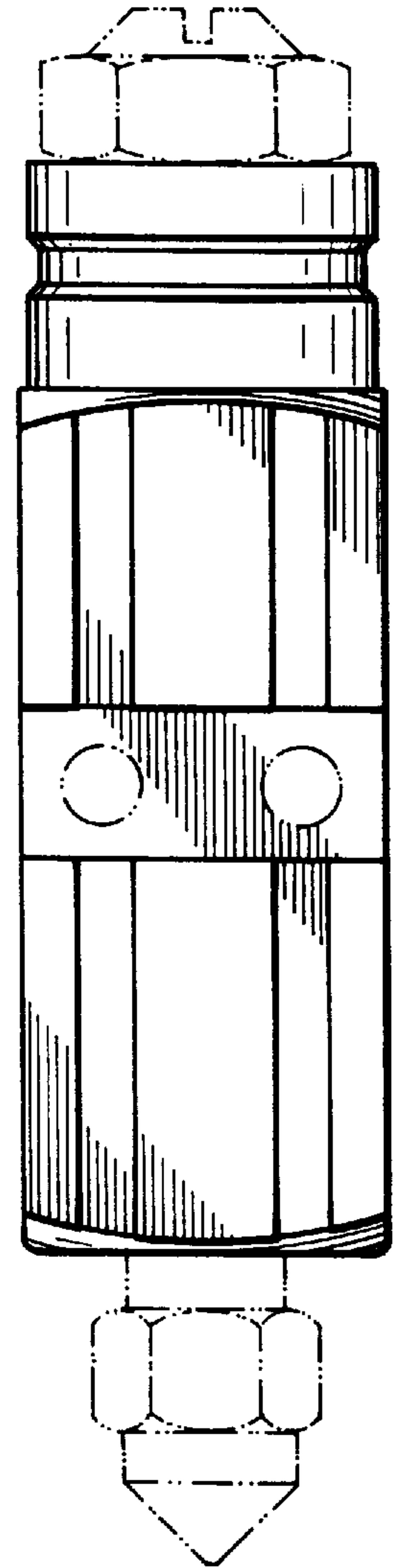

FIG. 15

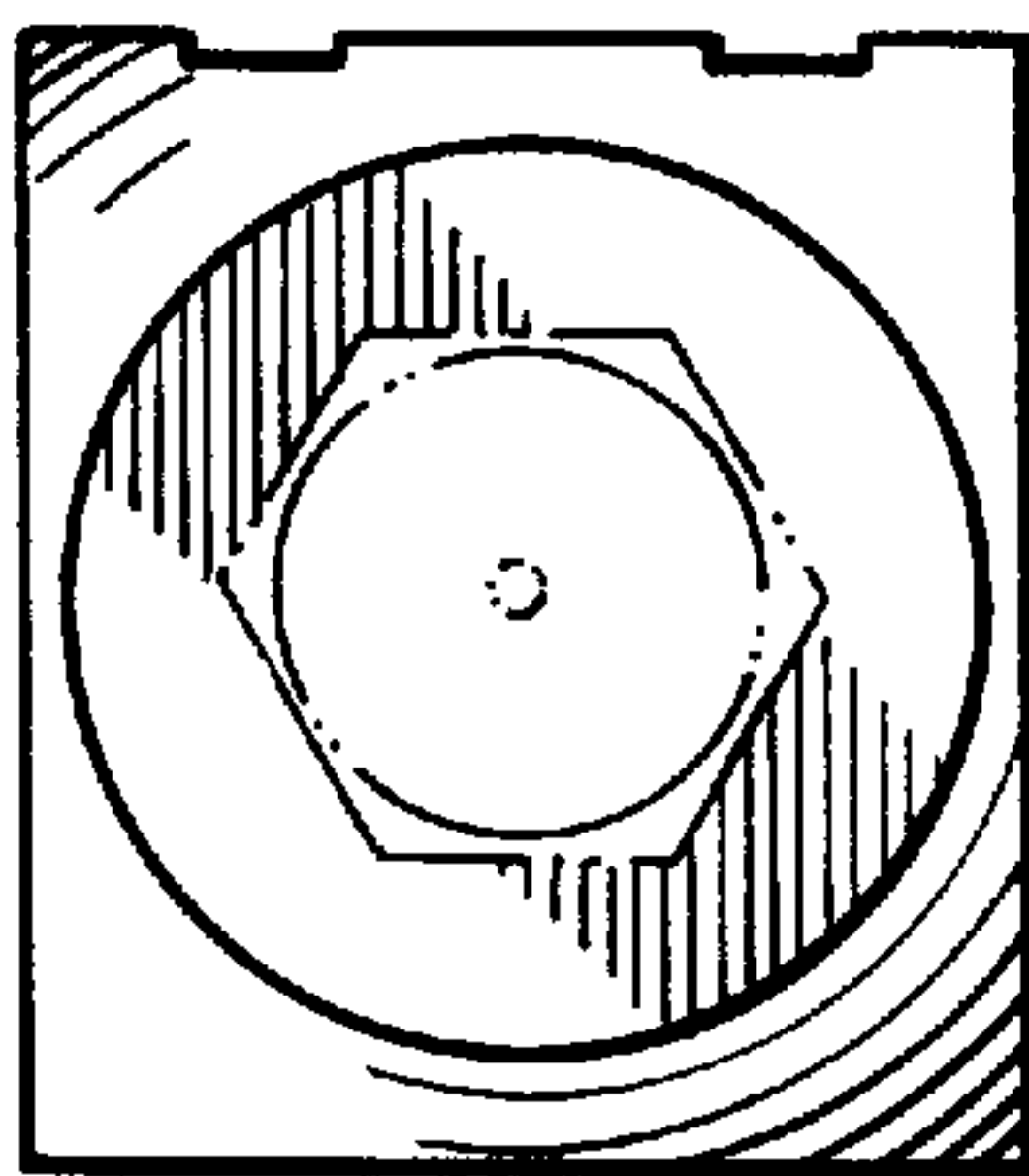

FIG. 16