



US00D401500S

United States Patent [19]

Perry et al.

[11] **Patent Number: Des. 401,500**

[45] **Date of Patent: **Nov. 24, 1998**

[54] **MULTI-PURPOSE HANGER**

[76] Inventors: **James Perry**, R.R. #2, Renfrew, ON, Canada, K7V 3Z5; **Bill Chatziannis**, 1493 Walkley Road, Ottawa, ON, Canada, K1V 0H3

[**] Term: **14 Years**

[21] Appl. No.: **78,855**

[22] Filed: **Nov. 5, 1997**

[51] **LOC (6) Cl. 08-05**

[52] **U.S. Cl. D8/373**

[58] **Field of Search D8/373, 367; 248/301, 248/304, 339, 317**

[56] **References Cited**

U.S. PATENT DOCUMENTS

D. 391,146 3/1997 Cutler D8/367

Primary Examiner—Holly Baynham
Attorney, Agent, or Firm—Robert A. Wilkes

[57] CLAIM

The ornamental design for a multi-purpose hanger, as shown and described.

DESCRIPTION

FIG. 1 is a perspective view;
FIG. 2 is a back view;
FIG. 3 is a side view thereof with the opposite side being a mirror image;
FIG. 4 is a front view;
FIG. 5 is a top view; and,
FIG. 6 is a bottom view.

1 Claim, 2 Drawing Sheets

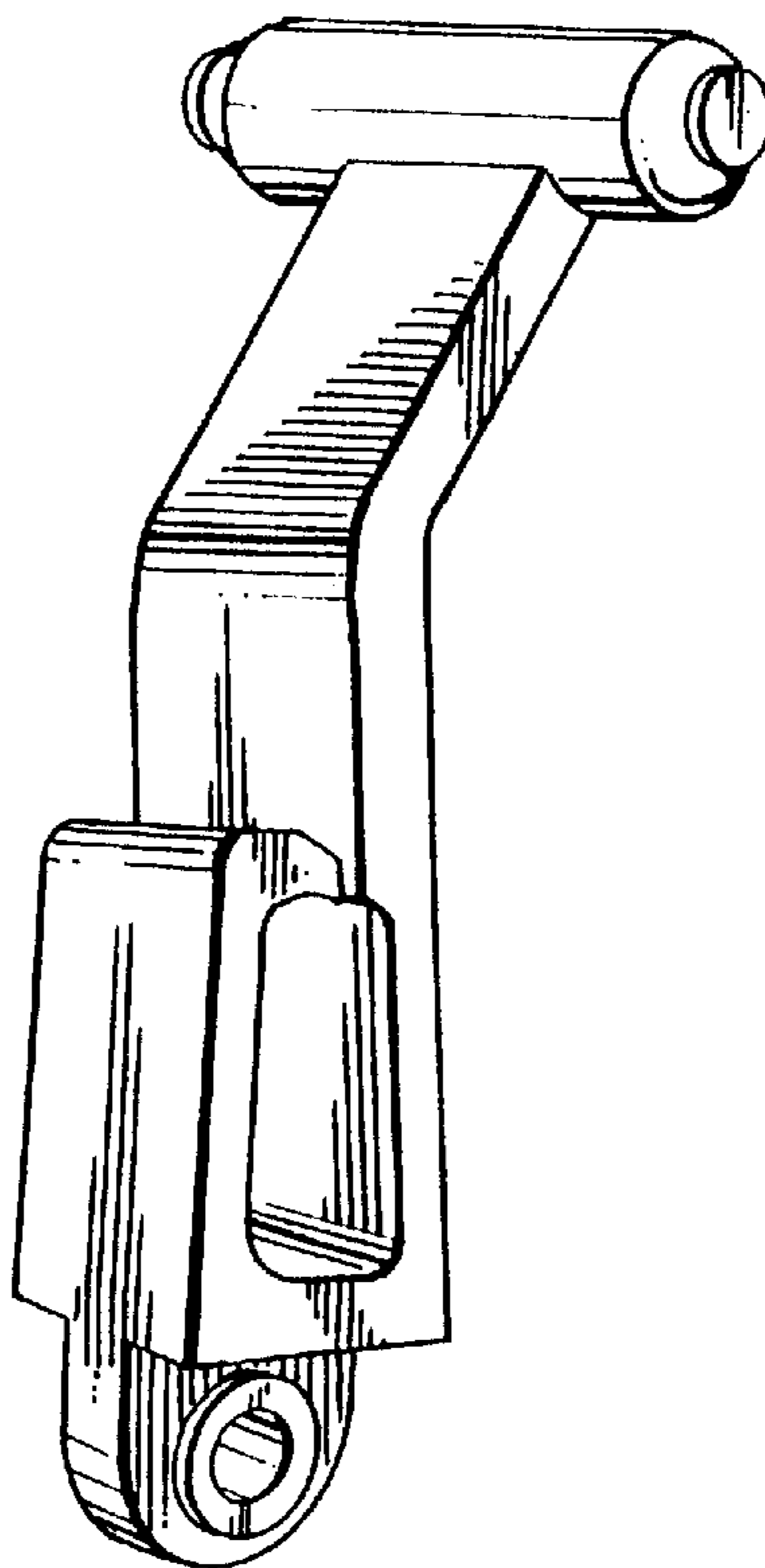

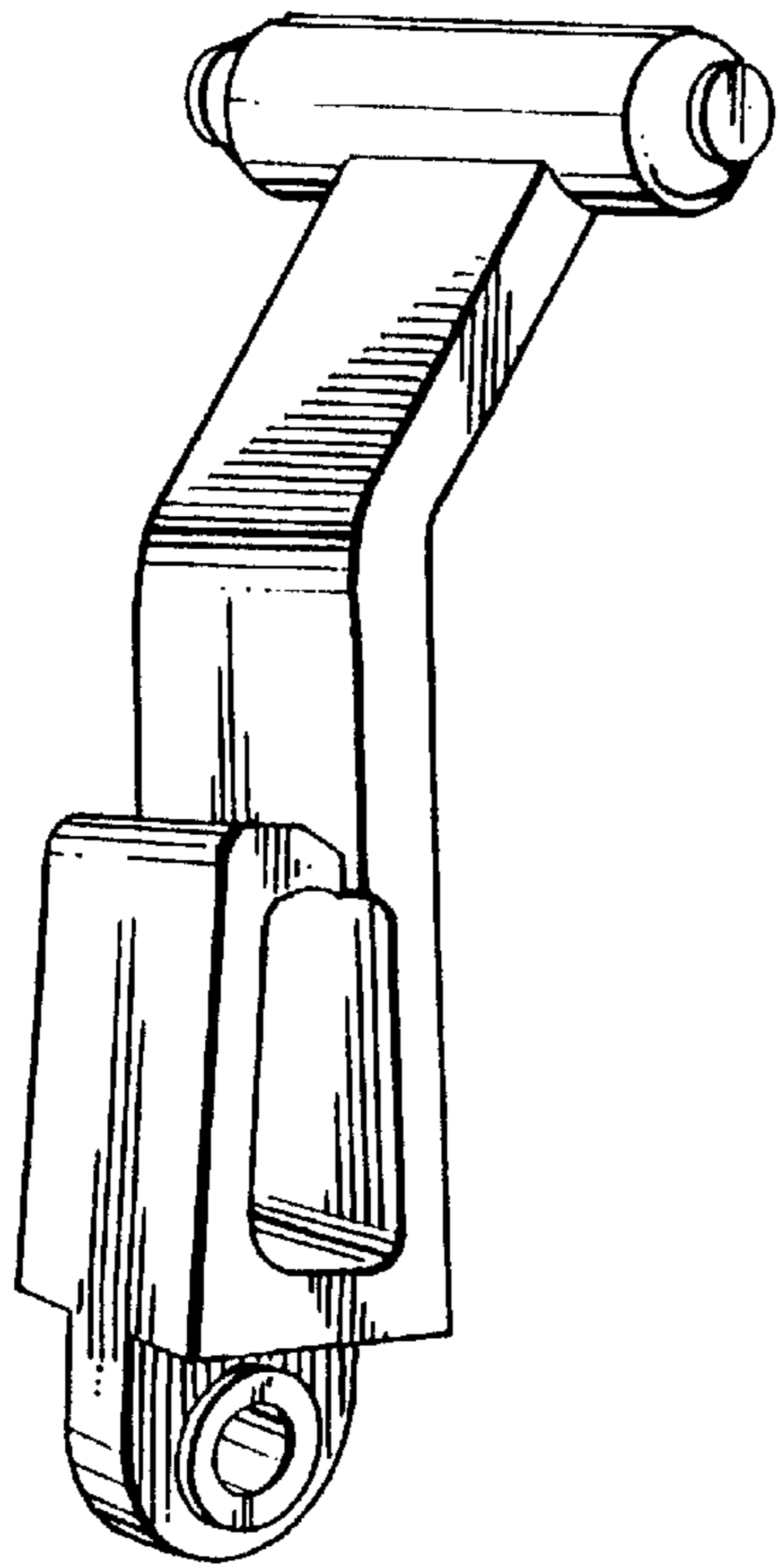

FIG. 1

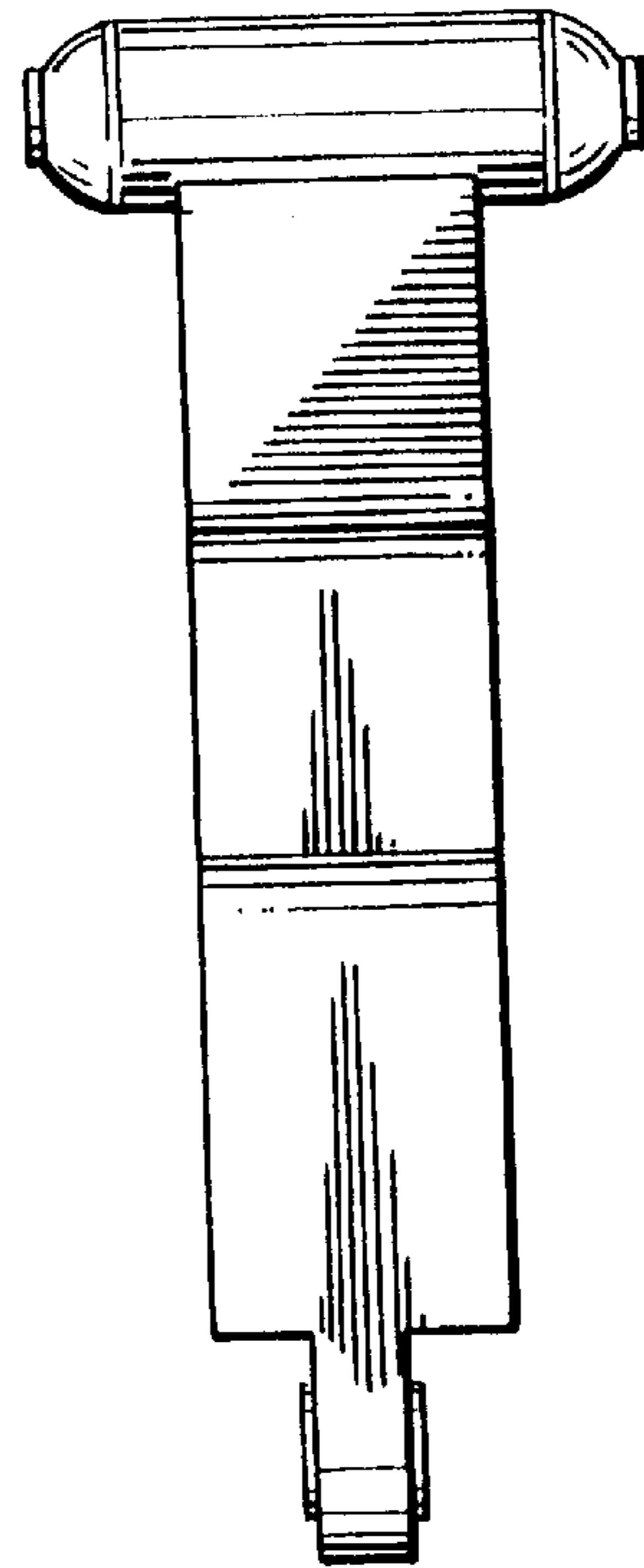

FIG. 2

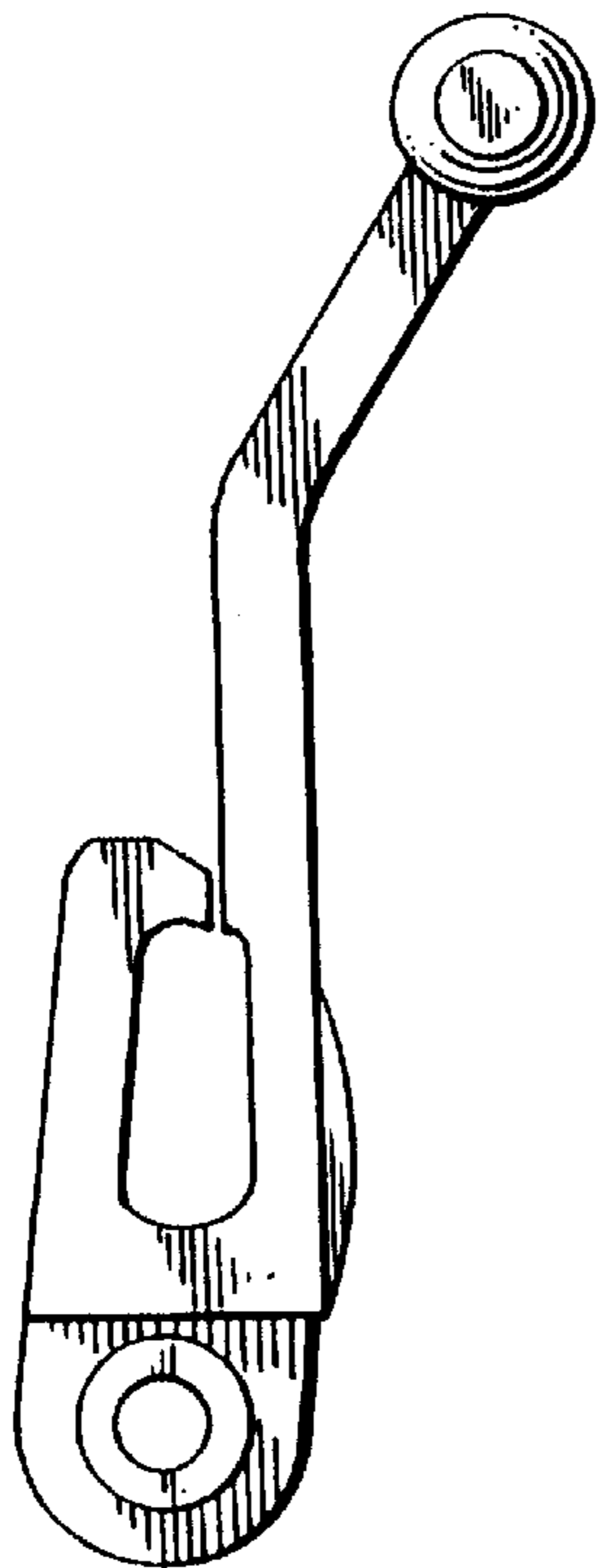

FIG. 3

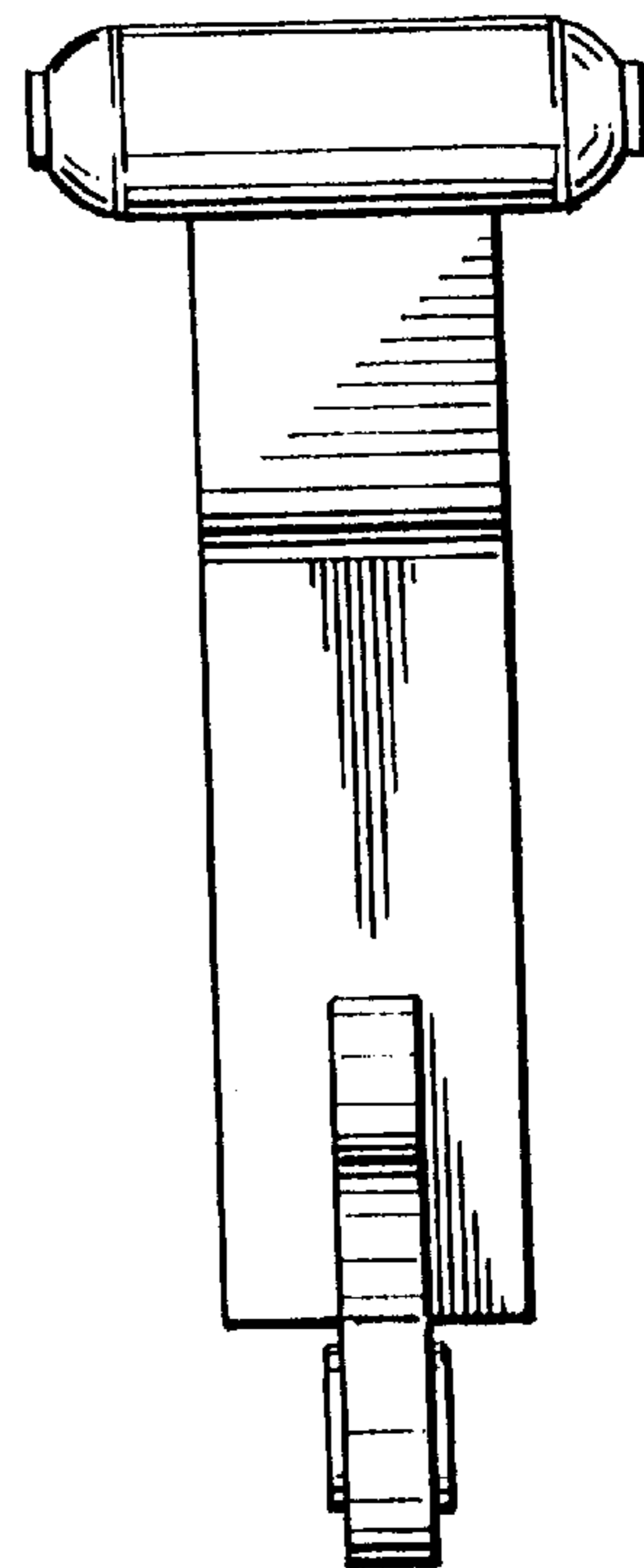

FIG. 4

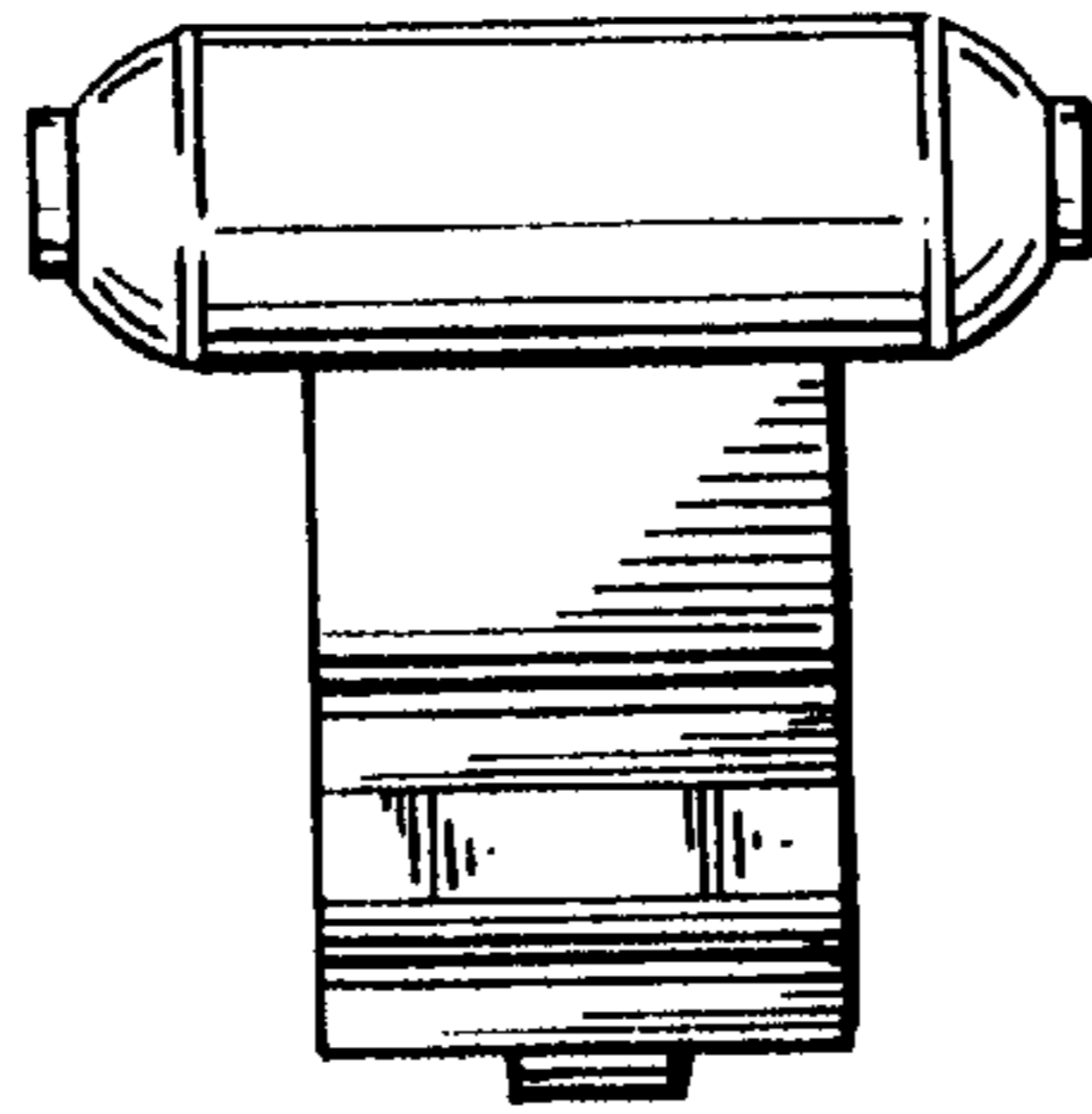

FIG. 5

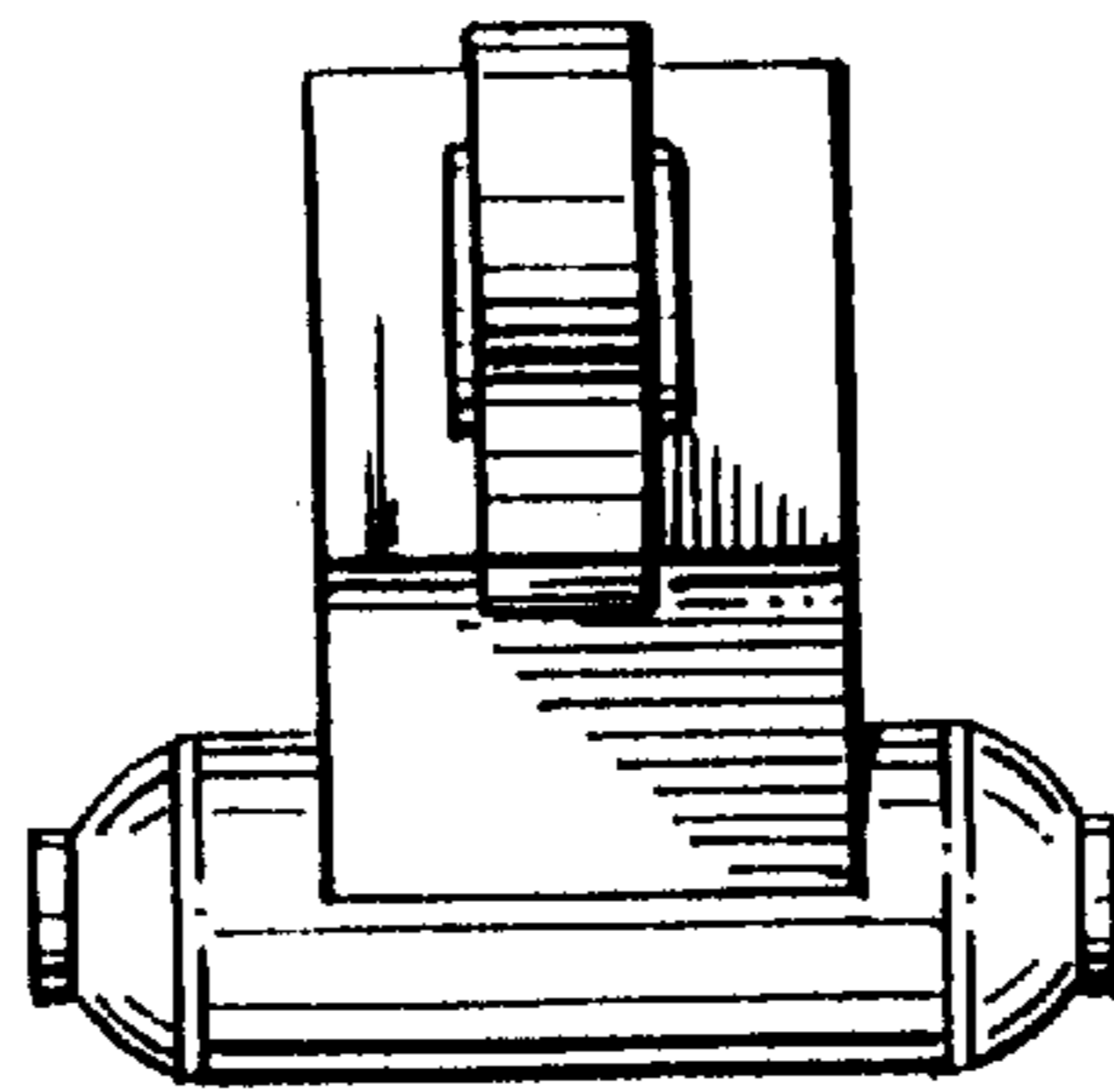

FIG. 6