



US00D401431S

United States Patent [19]

[11] **Patent Number: Des. 401,431**

Natuzzi et al.

[45] **Date of Patent: **Nov. 24, 1998**

[54] **SEAT**

[75] **Inventors: Pasquale Natuzzi; Arcangelo Scarati,**
both of Santeramo In Colle, Italy

[73] **Assignee: Industrie Natuzzi, Spa,** Santeramo,
Italy

[**] **Term: 14 Years**

[21] **Appl. No.: 77,022**

[22] **Filed: Sep. 15, 1997**

[51] **LOC (6) Cl. 06-01**

[52] **U.S. Cl. D6/381; D6/334; D6/335**

[58] **Field of Search D6/334, 335, 336,**
D6/364, 371, 373, 377, 381, 500, 501,
502; 297/232, 445.1

[56] **References Cited**

U.S. PATENT DOCUMENTS

D. 353,062	12/1994	Natuzzi et al.	D6/381
D. 363,614	10/1995	Natuzzi et al.	D6/381
D. 365,458	12/1995	Natuzzi et al.	D6/381
D. 365,459	12/1995	Natuzzi et al.	D6/381
D. 367,366	2/1996	Natuzzi et al.	D6/381
D. 374,356	10/1996	Natuzzi et al.	D6/381
D. 388,259	12/1997	Natuzzi et al.	D6/381

OTHER PUBLICATIONS

Natuzzi Model 762, Apr. 1990, at International Home Furnishings Market in High Point, North Carolina.
 Natuzzi Model 827, Apr. 1991, at International Home Furnishings Market in High Point, North Carolina.
 Natuzzi Model 879, Apr. 1991, at International Home Furnishings Market in High Point, North Carolina.
 Natuzzi Model 893, Nov. 1991, at International Home Furnishings Market in High Point, North Carolina.
 Natuzzi Model 1034, Apr. 1993, at International Home Furnishings Market in High Point, North Carolina.
 Natuzzi Model 1094, Oct. 1993, at International Home Furnishings Market in High Point, North Carolina.
 Natuzzi Model 1118, Jan. 1994, at International Home Furnishings Market in High Point, North Carolina.
 Natuzzi Model 1129, Jan. 1994, at International Home Furnishings Market in High Point, North Carolina.

Natuzzi Model 1145, Apr. 1994, at International Home Furnishings Market in High Point, North Carolina.
 Natuzzi Model 1152, Apr. 1994, at International Home Furnishings Market in High Point, North Carolina.
 Natuzzi Model 1156, Apr. 1994, at International Home Furnishings Market in High Point, North Carolina.
 Natuzzi Model 1168, Apr. 1994, at International Home Furnishings Market in High Point, North Carolina.
 Natuzzi Model 1207, Oct. 1994, at International Home Furnishings Market in High Point, North Carolina.
 Natuzzi Model 1337, Sep. 1995, at International Home Furnishings Market in High Point, North Carolina.
 Natuzzi Model 1446, Mar. 1996, at International Home Furnishings Market in High Point, North Carolina.

Primary Examiner—Gary D. Watson
Attorney, Agent, or Firm—Bell Seltzer Intellectual Property Law Group of Alston & Bird LLP

[57] **CLAIM**

The ornamental design for a seat, as shown and described.

DESCRIPTION

FIG. 1 is a front perspective view of a seat showing our new design in the form of a sofa;
 FIG. 2 is a front elevational view thereof;
 FIG. 3 is a top plan view thereof;
 FIG. 4 is a right side elevational view, the left side being a mirror image thereof;
 FIG. 5 is a rear perspective view thereof;
 FIG. 6 is a front elevational view of a seat showing our new design in the form of a loveseat;
 FIG. 7 is front elevational view of a seat showing our new design in the form of a chair;
 FIG. 8 is a front perspective view of a seat showing our new design in the form of a sectional;
 FIG. 9 is a top plan view thereof; and,
 FIG. 10 is a rear perspective view thereof.
 The broken lines shown herein are for illustrative purposes only and form no part of the claimed design.
 The rear views of FIGS. 6 and 7 are like FIG. 5, the difference being a matter of length.
 The end views of FIGS. 6 and 7 are like that shown in FIG. 4.
 FIGS. 1 and 5 have been shown on an enlarged scale with respect to the other views.

1 Claim, 6 Drawing Sheets

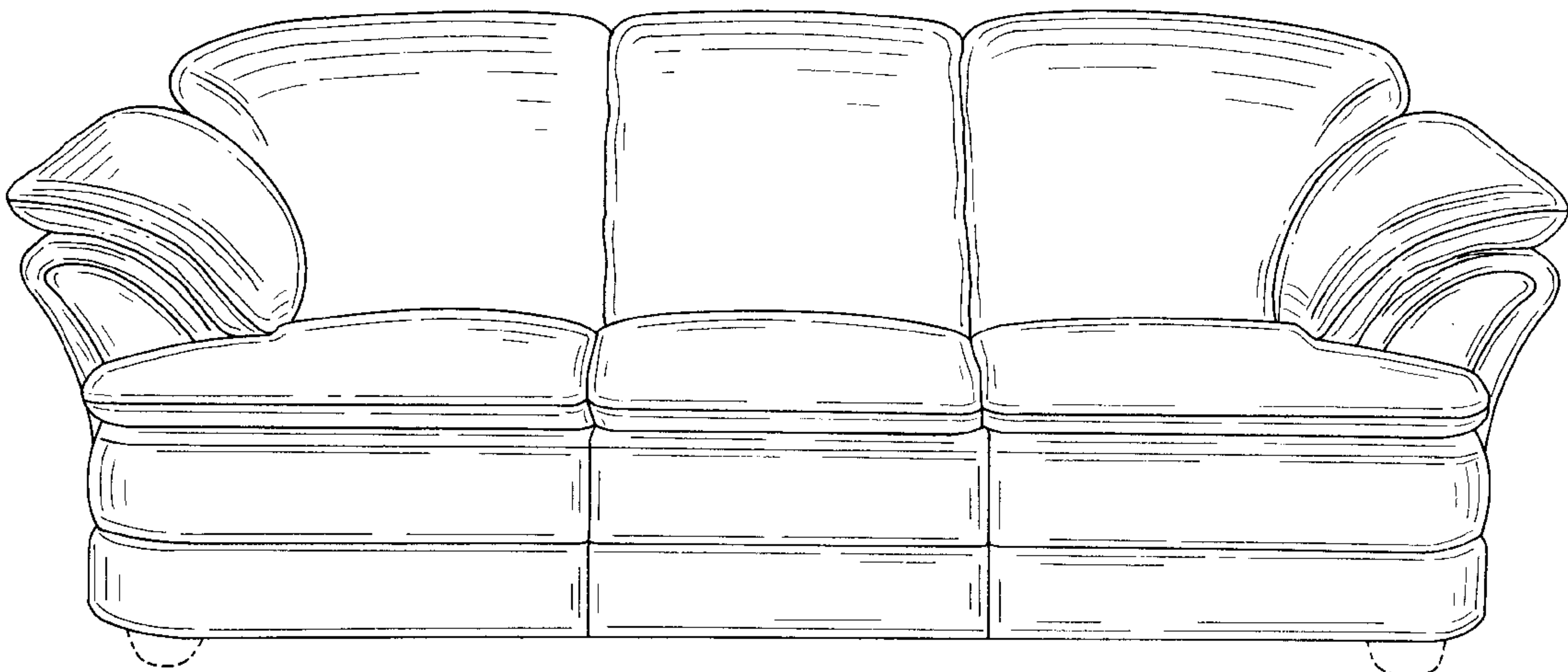

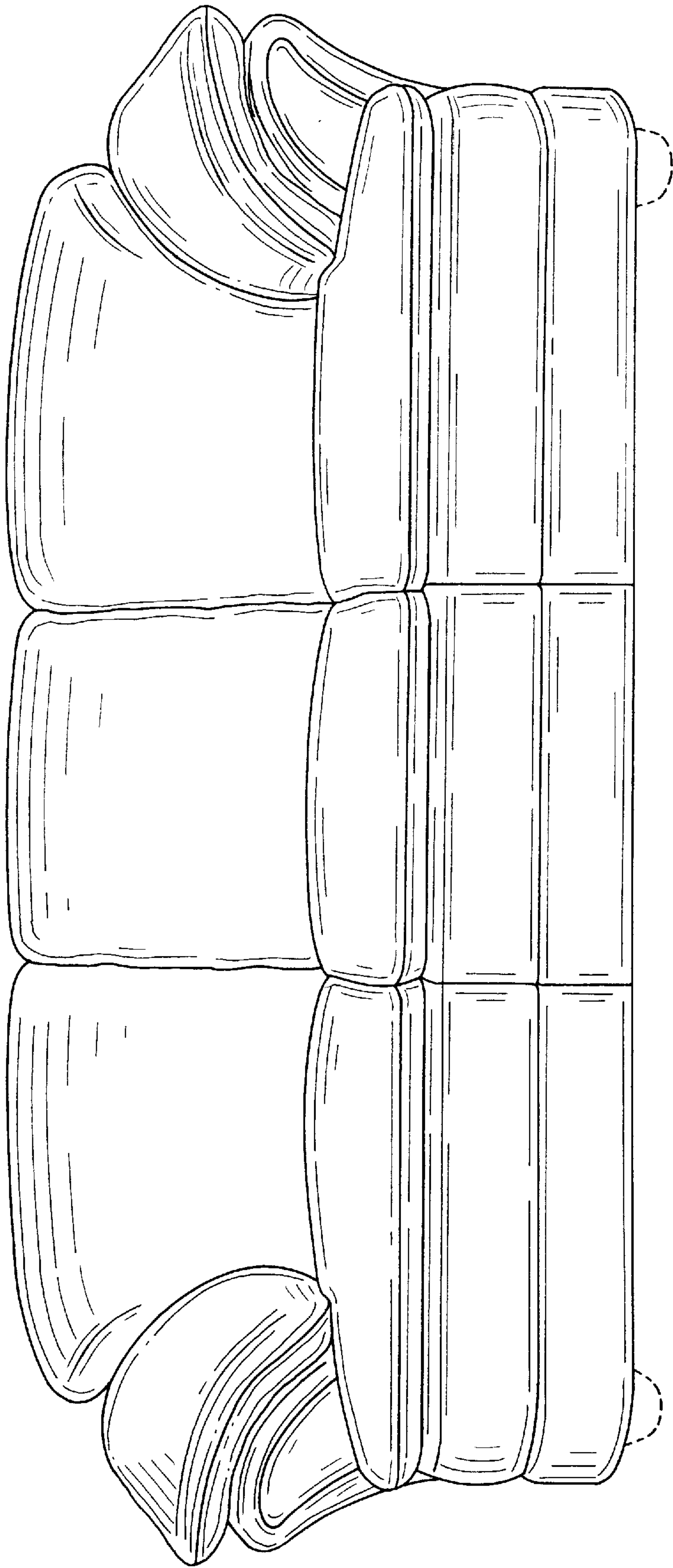

FIG. 1.

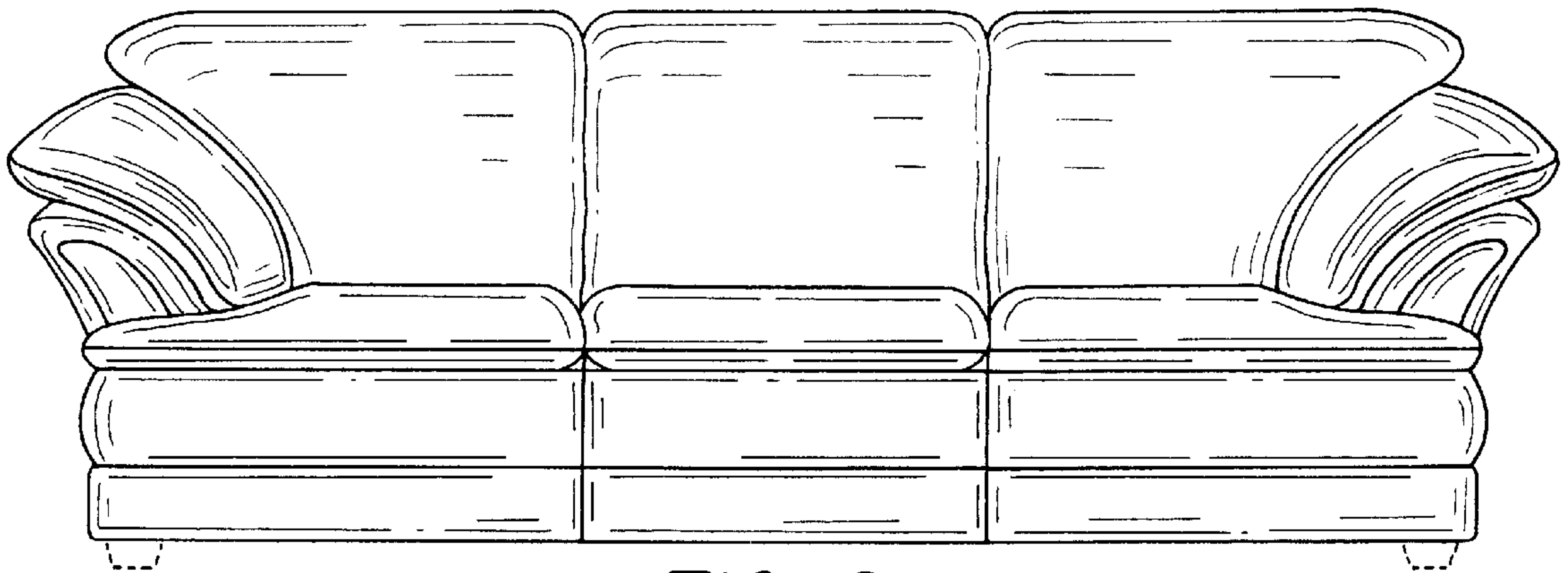

FIG. 2.

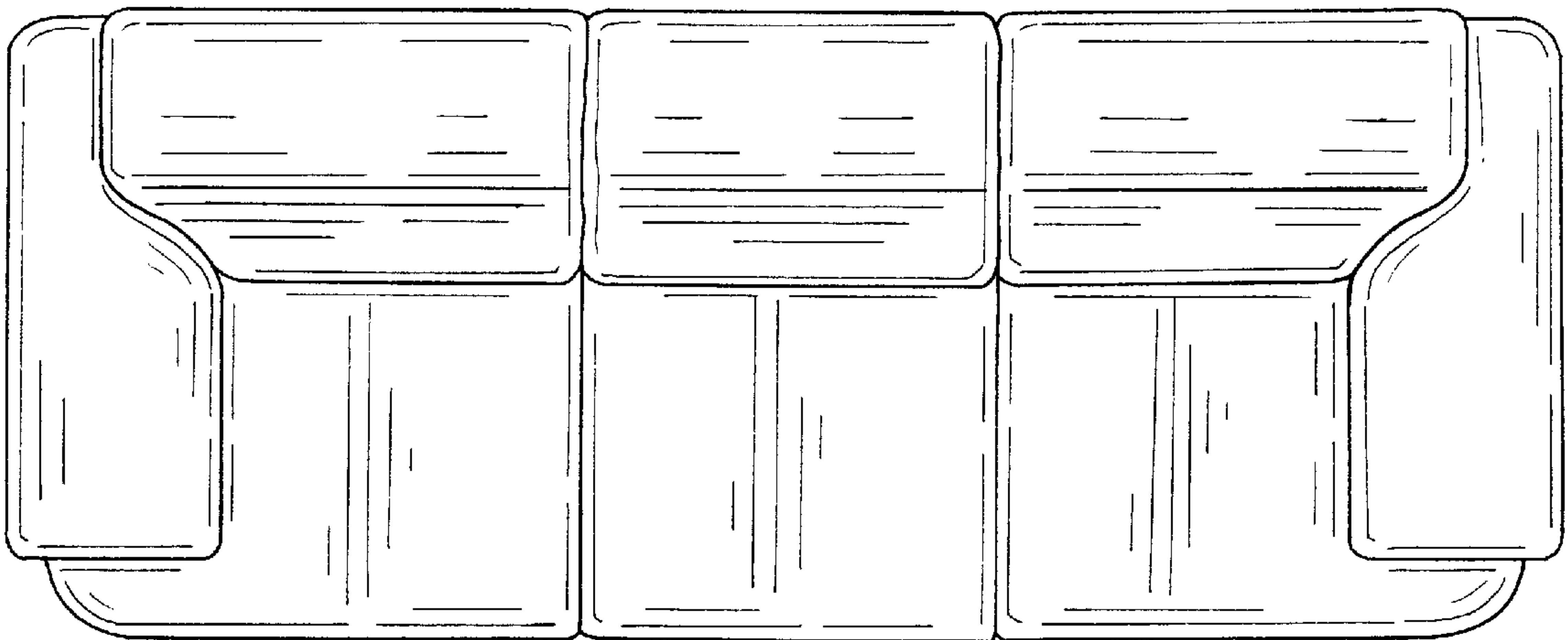

FIG. 3.

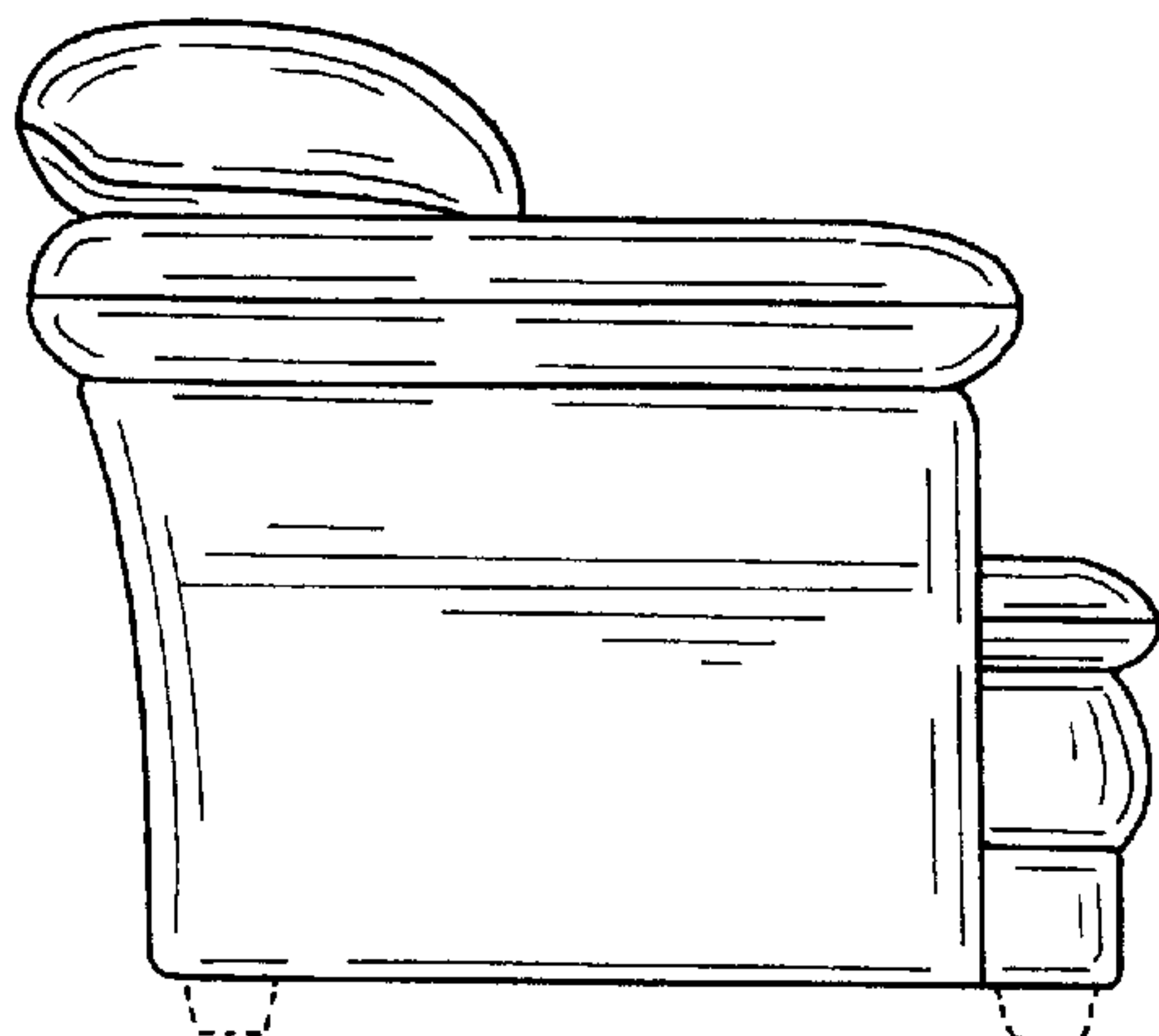

FIG. 4.

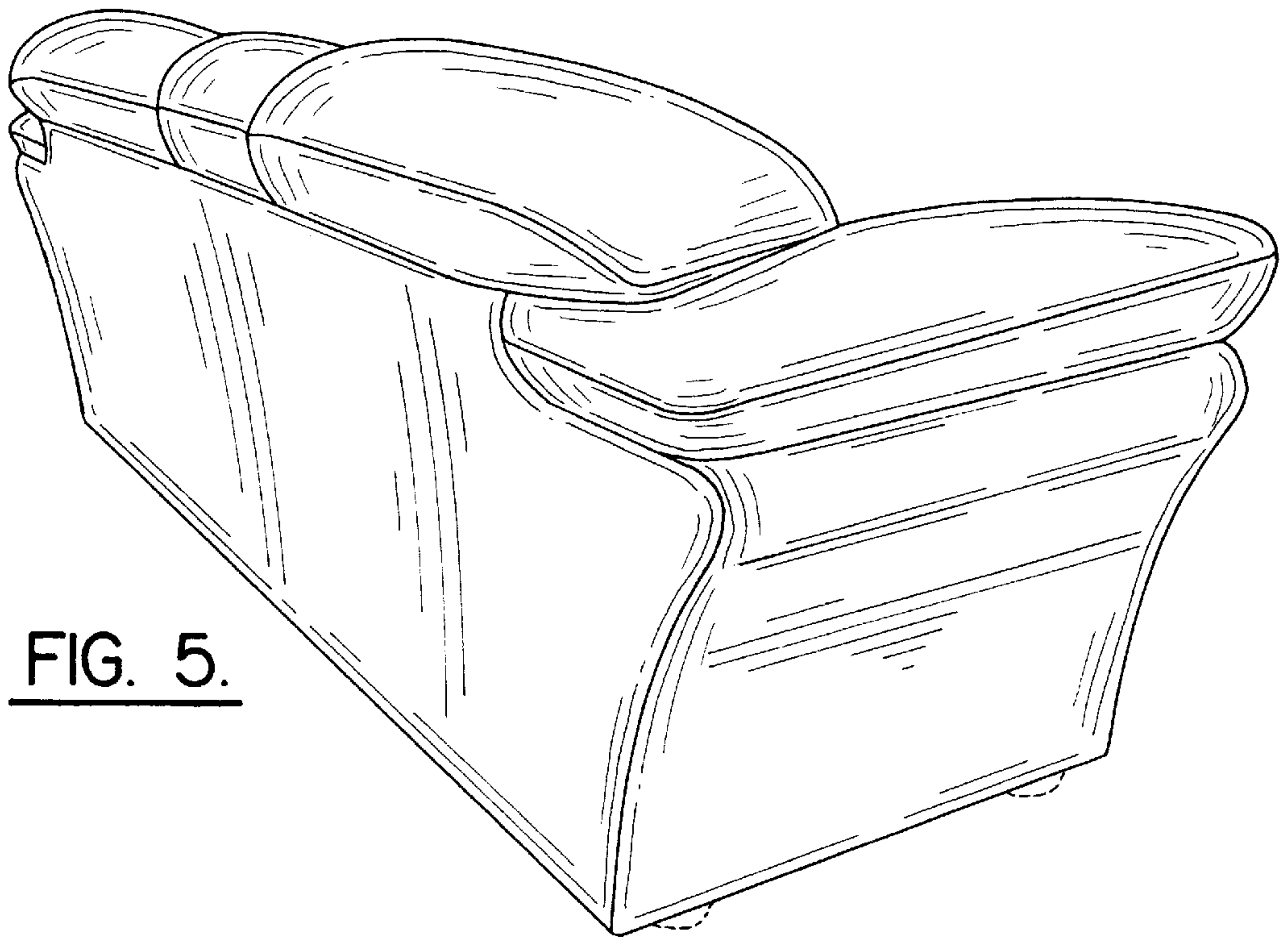

FIG. 5.

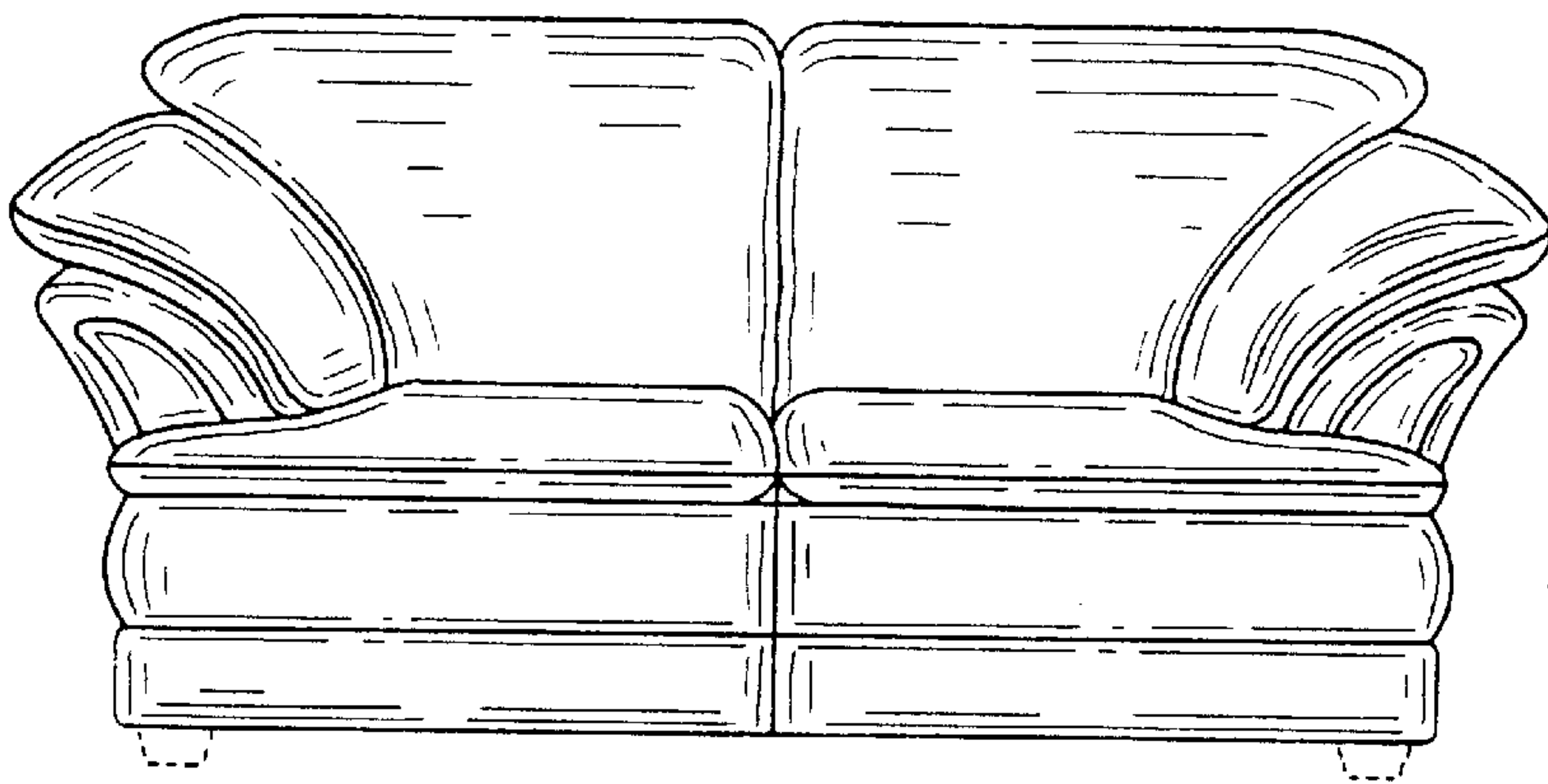

FIG. 6.

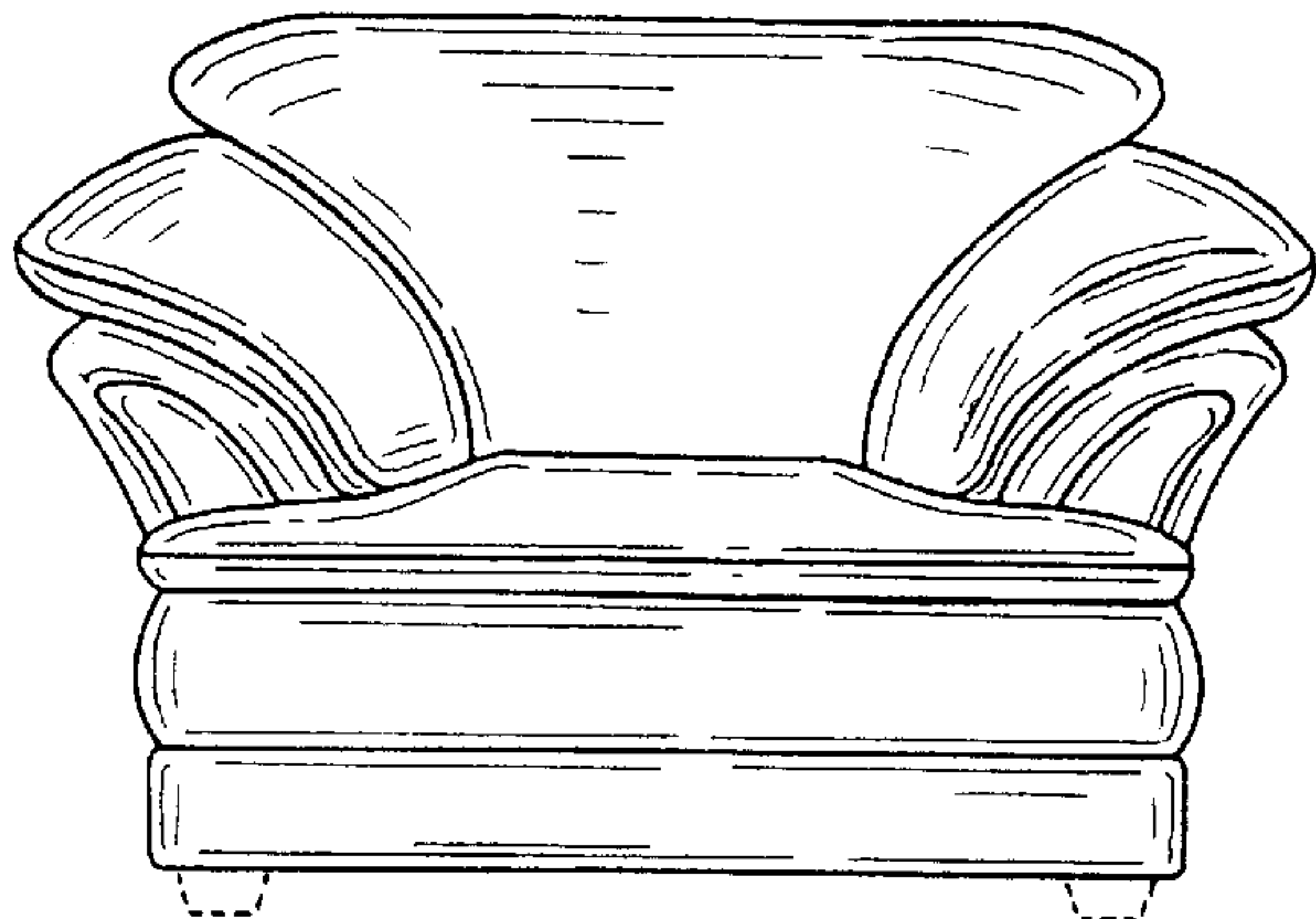

FIG. 7.

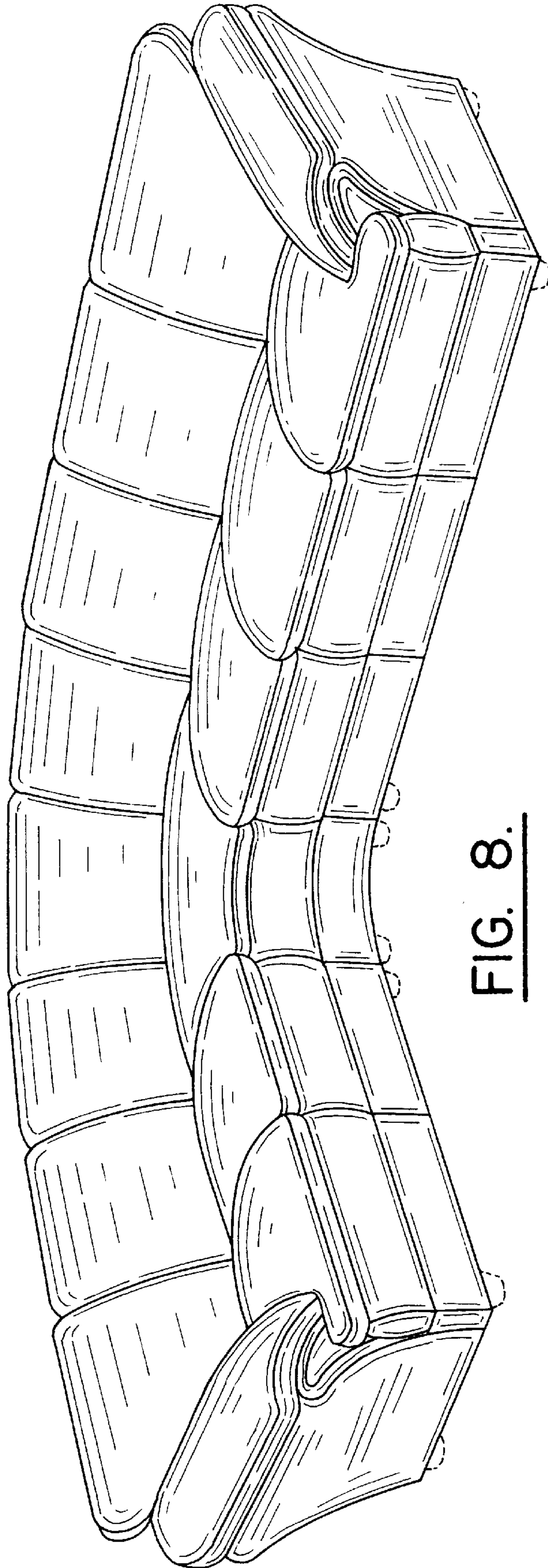

FIG. 8.

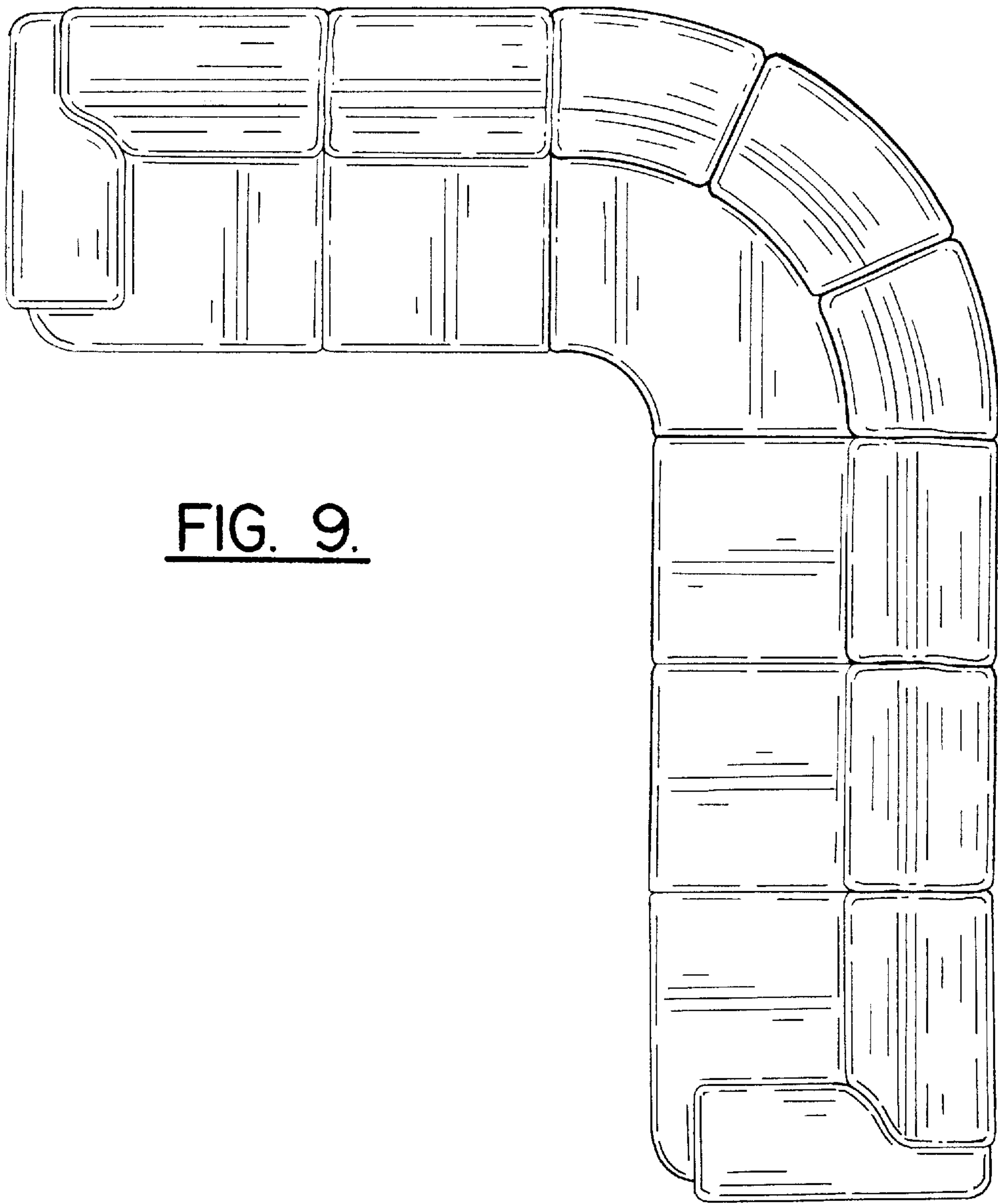

FIG. 9.

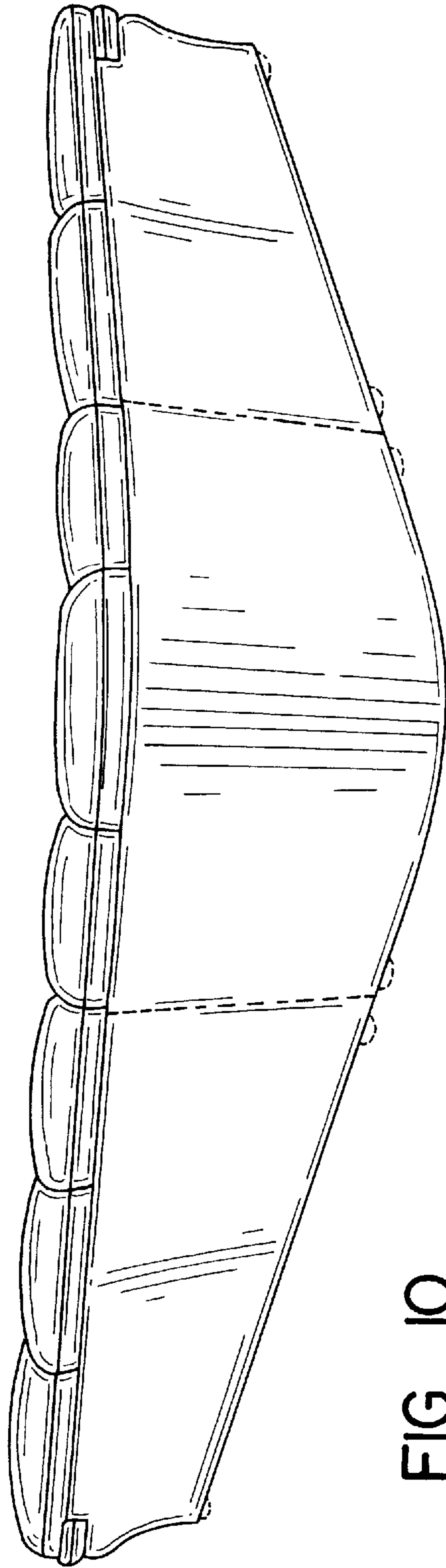

FIG. 10.