



US00D401406S

# United States Patent [19]

Alves et al.

[11] **Patent Number: Des. 401,406**

[45] **Date of Patent: \*\*Nov. 24, 1998**

[54] **PERSONAL ITEMS TRANSPORT CASE**

D. 382,900 8/1997 Wyant ..... D3/303 X  
D. 383,492 9/1997 Siemon et al. .... D3/303 X

[75] Inventors: **Roger J. Alves**, Simi Valley; **Kasidy W. Alves**, Oxnard, both of Calif.

*Primary Examiner*—Doris V. Coles  
*Assistant Examiner*—Catherine R. Oliver  
*Attorney, Agent, or Firm*—William W. Haefliger

[73] Assignee: **Scosche Industries, Inc.**, Oxnard, Calif.

[\*\*] Term: **14 Years**

### [57] CLAIM

[21] Appl. No.: **69,513**

The ornamental design for personal items transport case, as shown and described.

[22] Filed: **Apr. 22, 1997**

### DESCRIPTION

[51] **LOC (6) Cl.** ..... **03-01**

FIG. 1 is a front elevational view of personal items transport case showing my new design;

[52] **U.S. Cl.** ..... **D3/215**

FIG. 2 is a right side elevational view thereof;

[58] **Field of Search** ..... D3/253, 303, 301,  
D3/900, 901, 232, 276, 285, 289, 201,  
205, 203; 150/147; 190/900, 901, 902,  
903, 115; 206/581, 424; D19/26, 27, 28

FIG. 3 is a left side elevational view thereof;

FIG. 4 is a rear elevational view thereof;

FIG. 5 is a top plan view thereof;

FIG. 6 is a bottom plan view thereof;

### [56] References Cited

#### U.S. PATENT DOCUMENTS

D. 116,977 10/1939 Bellau ..... D3/901 X  
D. 346,692 5/1994 Bromell ..... D3/901 X  
D. 352,604 11/1994 Johnson ..... D3/303  
D. 359,163 6/1995 Summerfield et al. .... D3/205

FIG. 7 is a front elevational view, with the case shown in an open position;

FIG. 8 is a front elevational view, with the case shown in an open position and the anterior flap shown folded; and,

FIG. 9 is a perspective view showing the interior of the case.

**1 Claim, 3 Drawing Sheets**

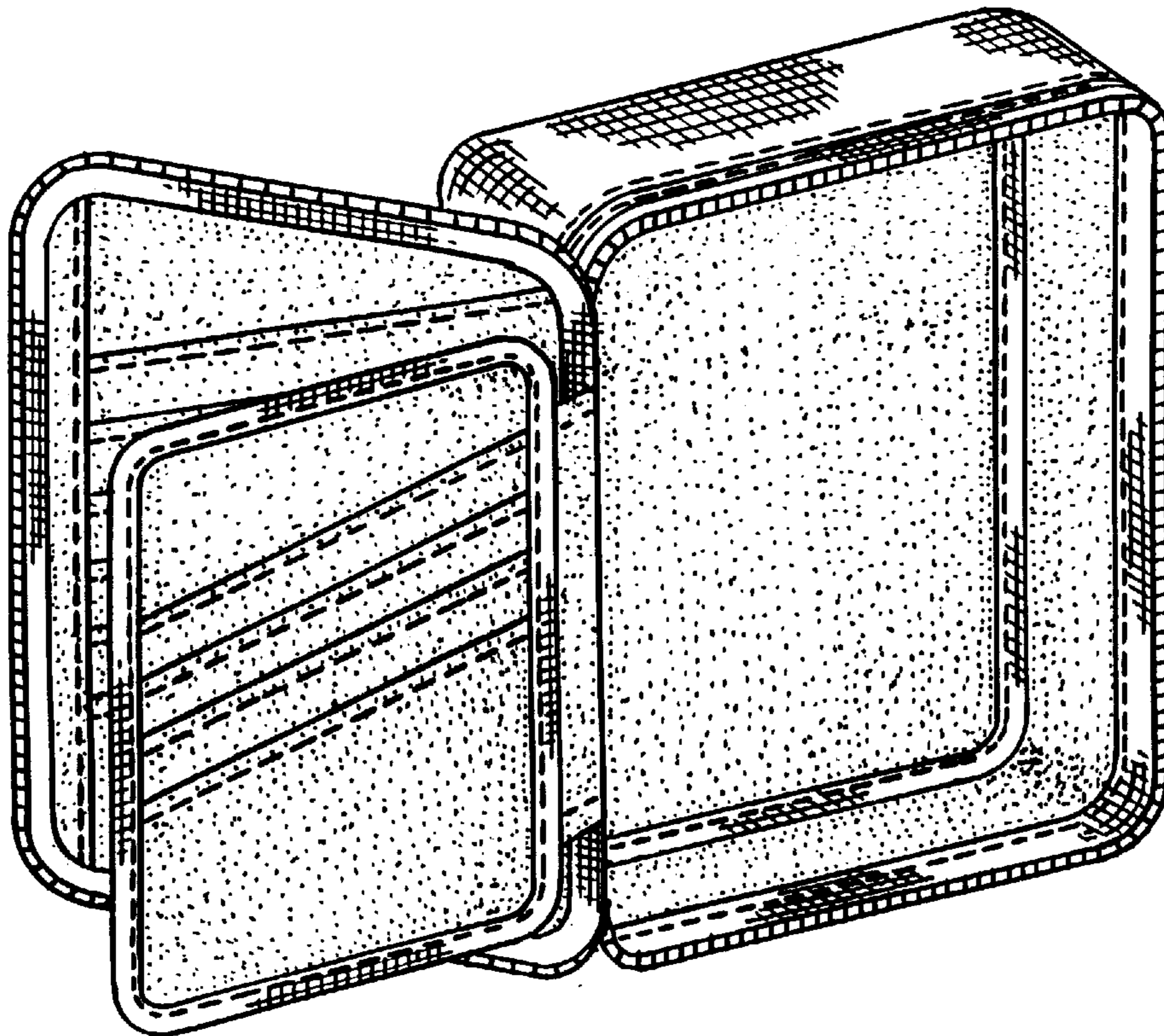

FIG. 1.

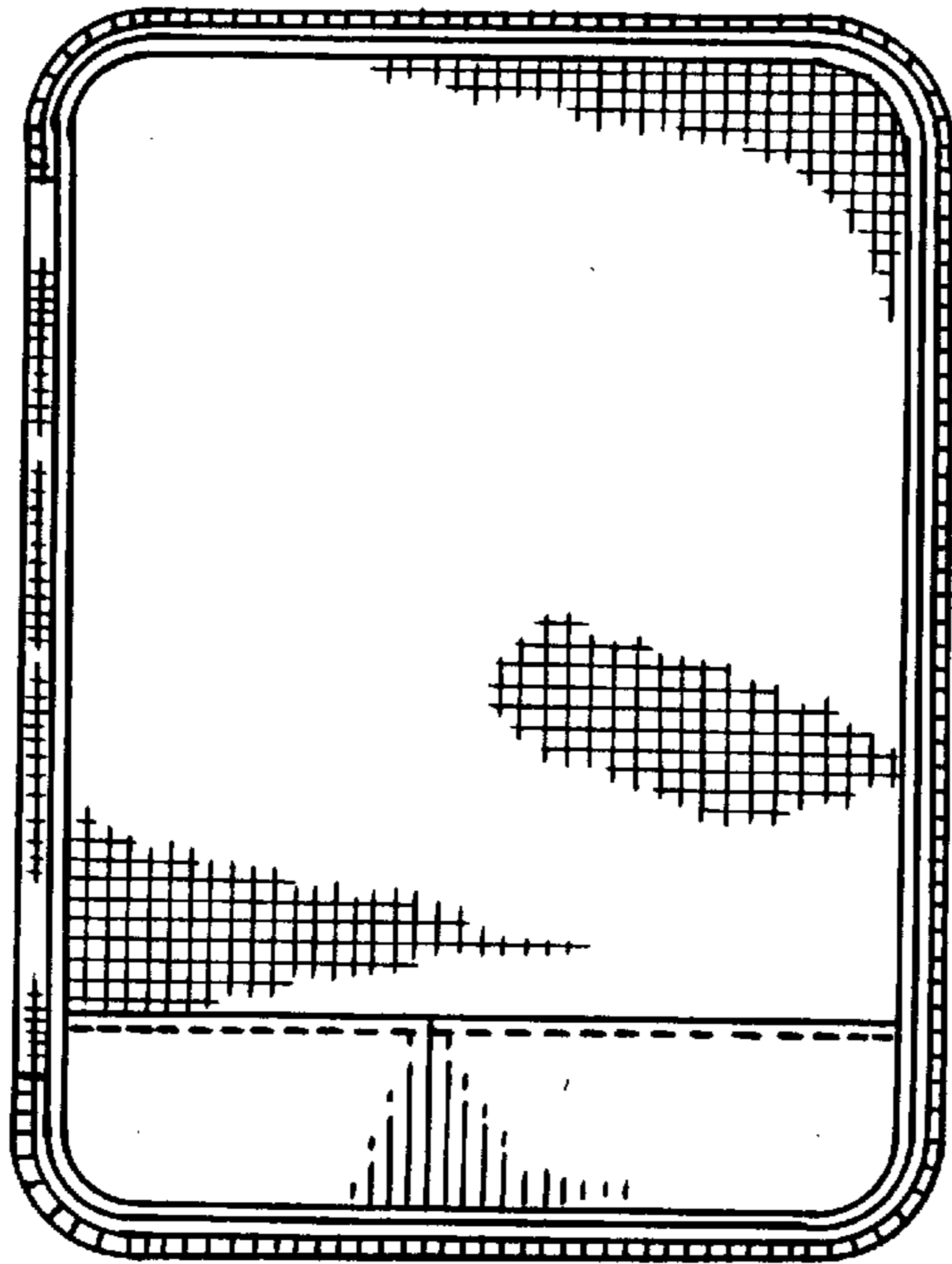

FIG. 2.

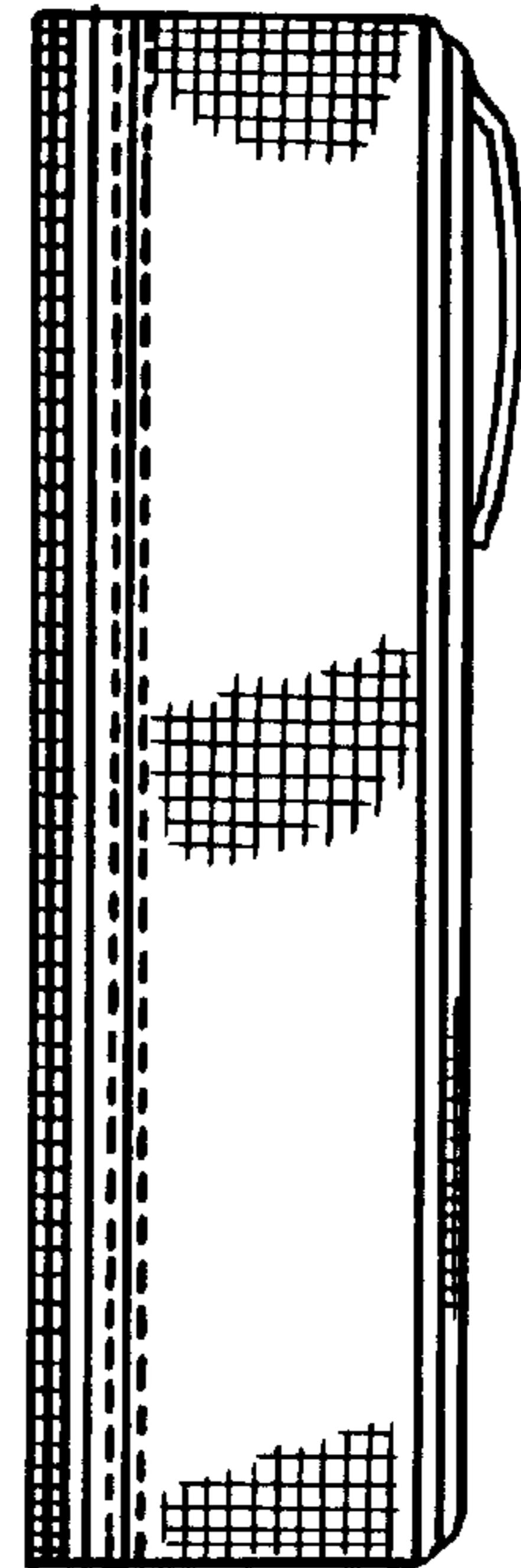

FIG. 4.

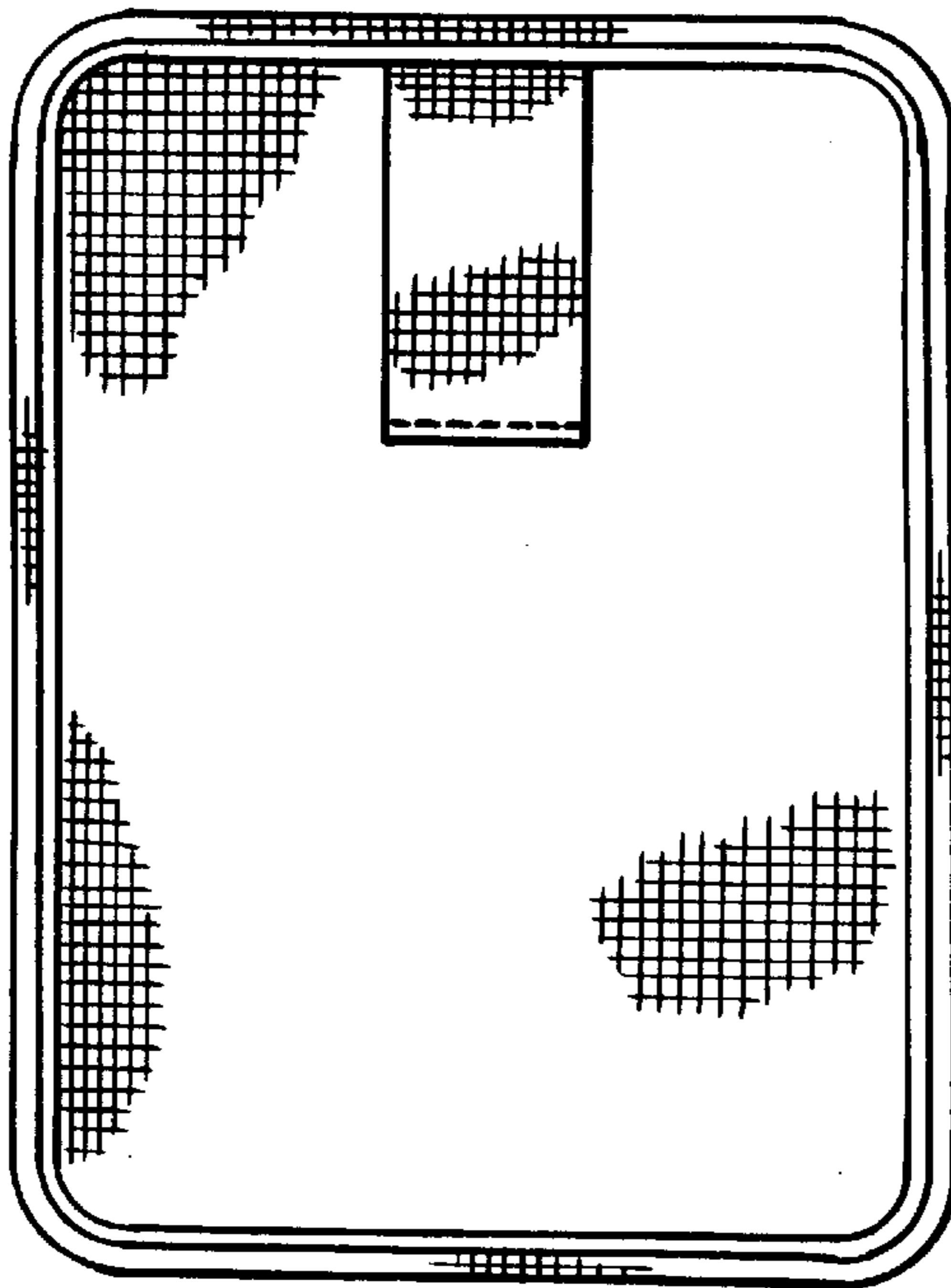

FIG. 3.

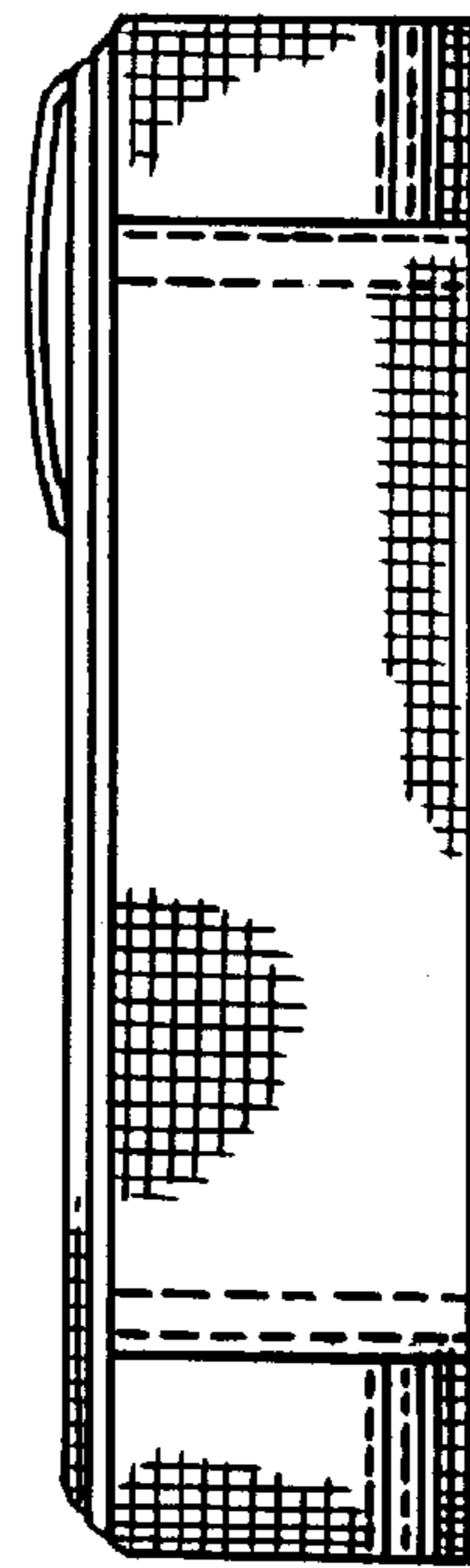

FIG. 5.

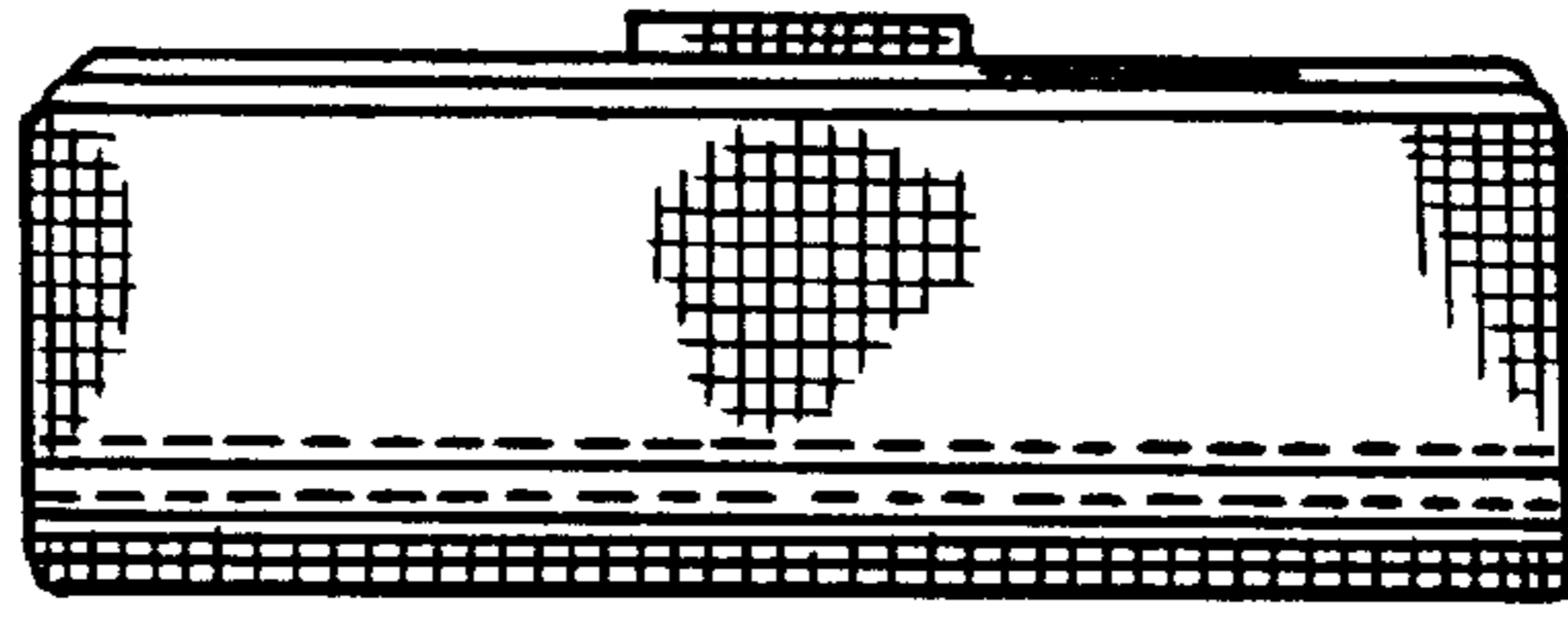

FIG. 6.

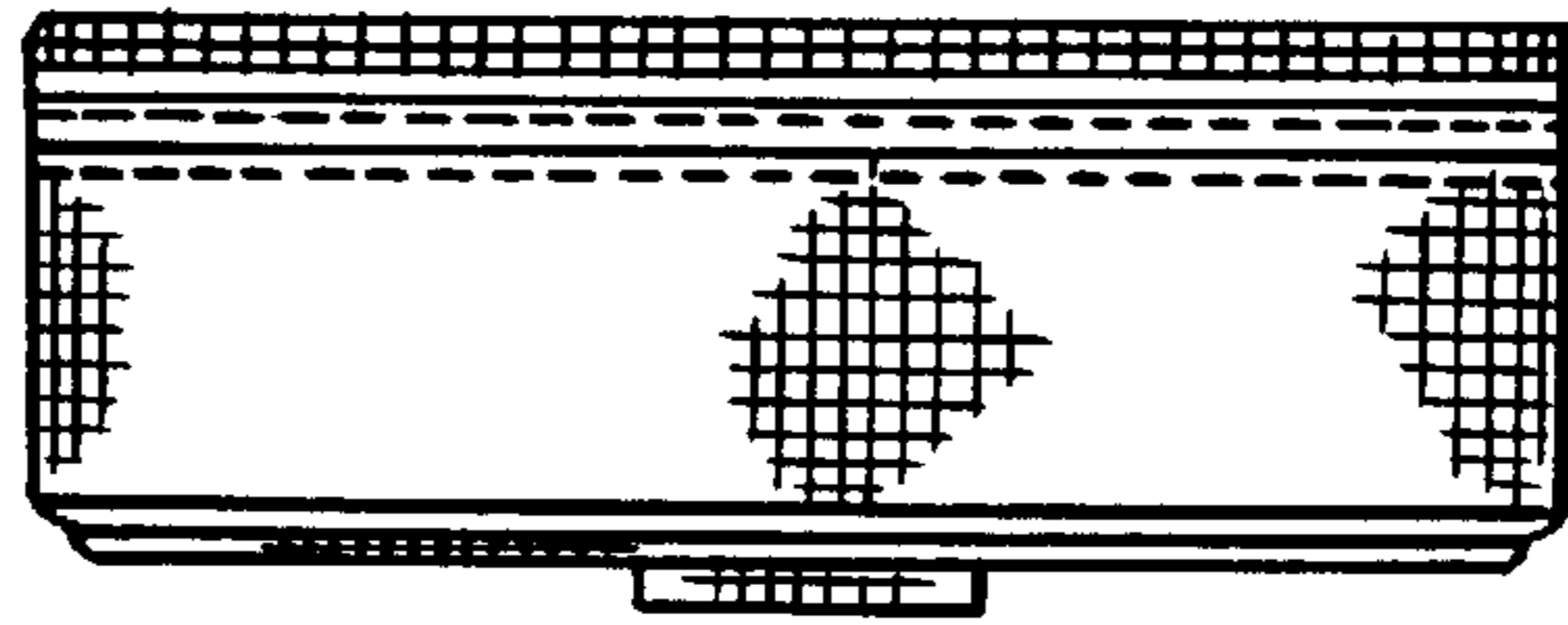

FIG. 7.

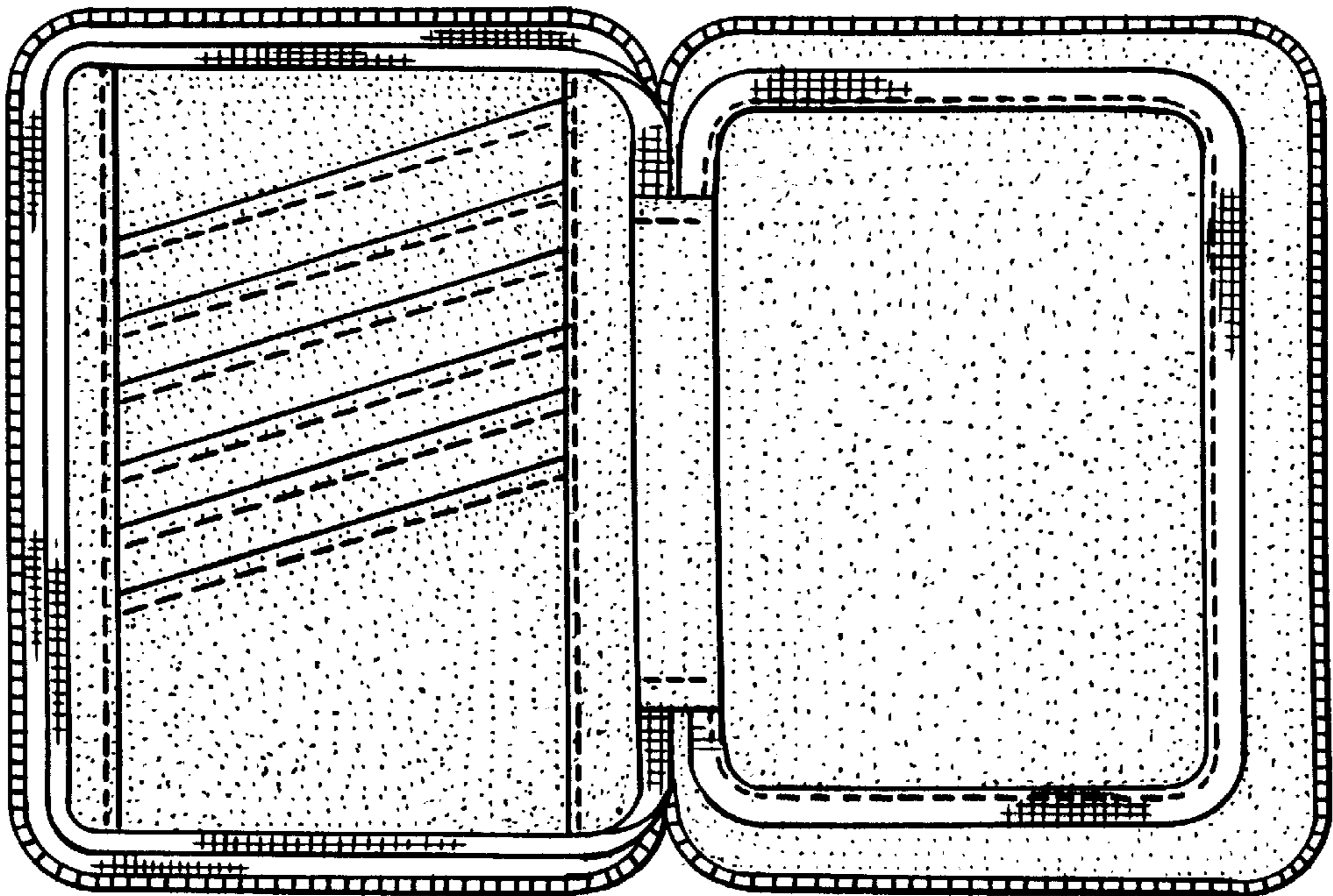



FIG. 8.

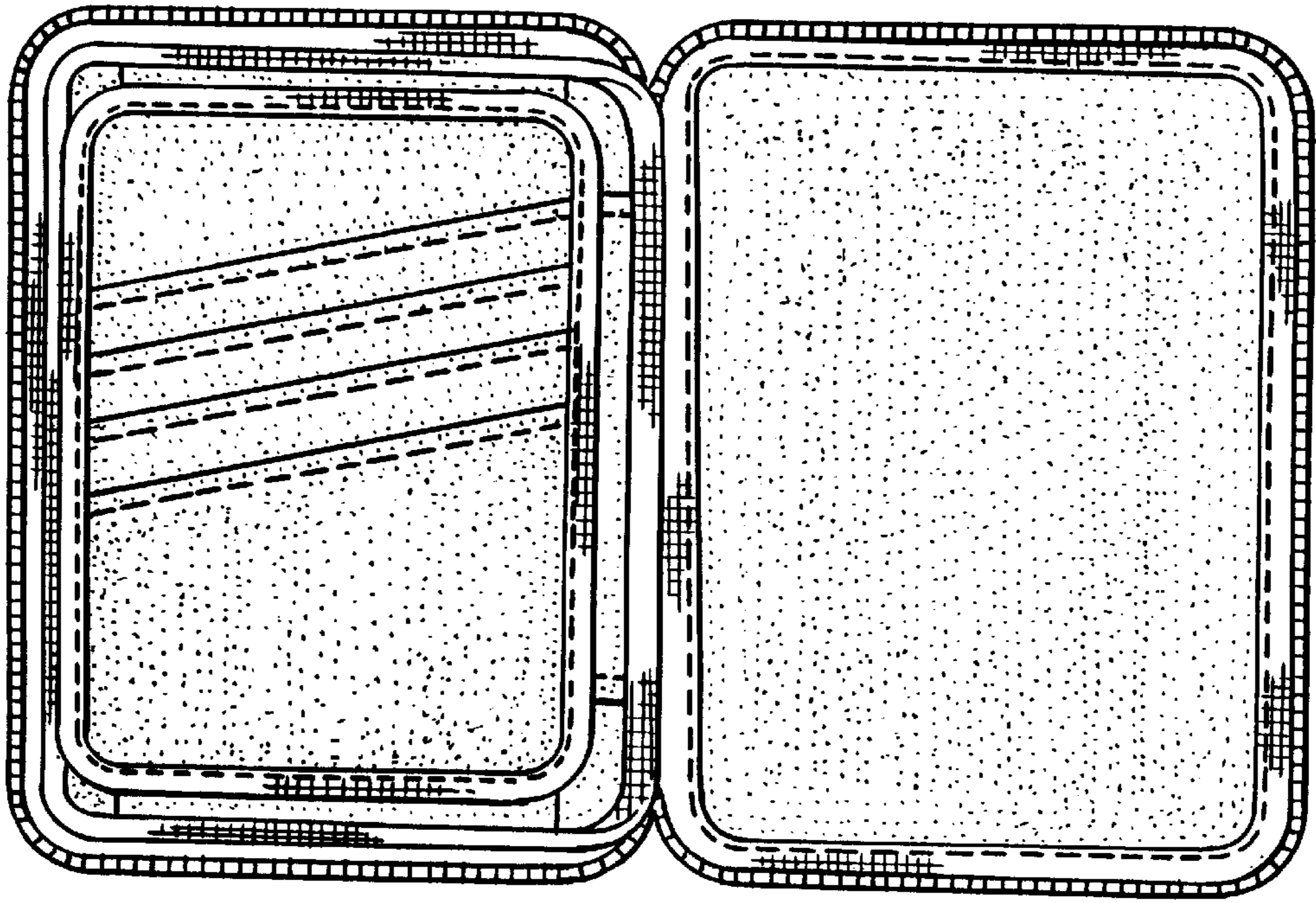

FIG. 9.

