



US00D401236S

United States Patent [19] Fong

[11] **Patent Number: Des. 401,236**

[45] **Date of Patent: **Nov. 17, 1998**

- [54] **RADIO INCORPORATED WITH STATIONERY ORGANIZER**
- [75] Inventor: **Tat-yin Fong**, Shatin, Hong Kong
- [73] Assignee: **Roundup International Ltd.**, Hong Kong, Hong Kong
- [**] Term: **14 Years**
- [21] Appl. No.: **80,512**
- [22] Filed: **Dec. 11, 1997**
- [51] **LOC (6) Cl.** **14-01**
- [52] **U.S. Cl.** **D14/168; D19/78**
- [58] **Field of Search** **D10/2, 15; D14/149, D14/150, 168, 170, 171, 188, 193-198, 299; D19/75, 78; 455/344, 347, 350, 351**

- [56] **References Cited**
- U.S. PATENT DOCUMENTS**
- D. 258,889 4/1981 Hayashi D10/2 X
- D. 280,402 9/1985 Brown D10/2 X
- D. 321,516 11/1991 Powell D10/2 X
- D. 369,600 5/1996 Zeitman D14/150 X

D. 382,007 8/1997 Peersmann D10/2 X

Primary Examiner—Ted Shooman
Assistant Examiner—Nanda Bondade
Attorney, Agent, or Firm—Samuels, Gauthier, Stevens & Reppert

[57] CLAIM

The ornamental design for a “radio incorporated with stationery organizer”, as shown and described.

DESCRIPTION

FIG. 1 is the front perspective view showing my new design; FIG. 2 is the front perspective view showing the parts in alternative position thereof; FIG. 3 is the front view thereof; FIG. 4 is the left-hand view thereof; FIG. 5 is the right-hand view thereof; FIG. 6 is the rear view thereof; FIG. 7 is the top view thereof; and, FIG. 8 is the bottom view thereof. The undisclosed views of the parts in alternative position shown in FIG. 2, form no part of the claimed design.

1 Claim, 6 Drawing Sheets

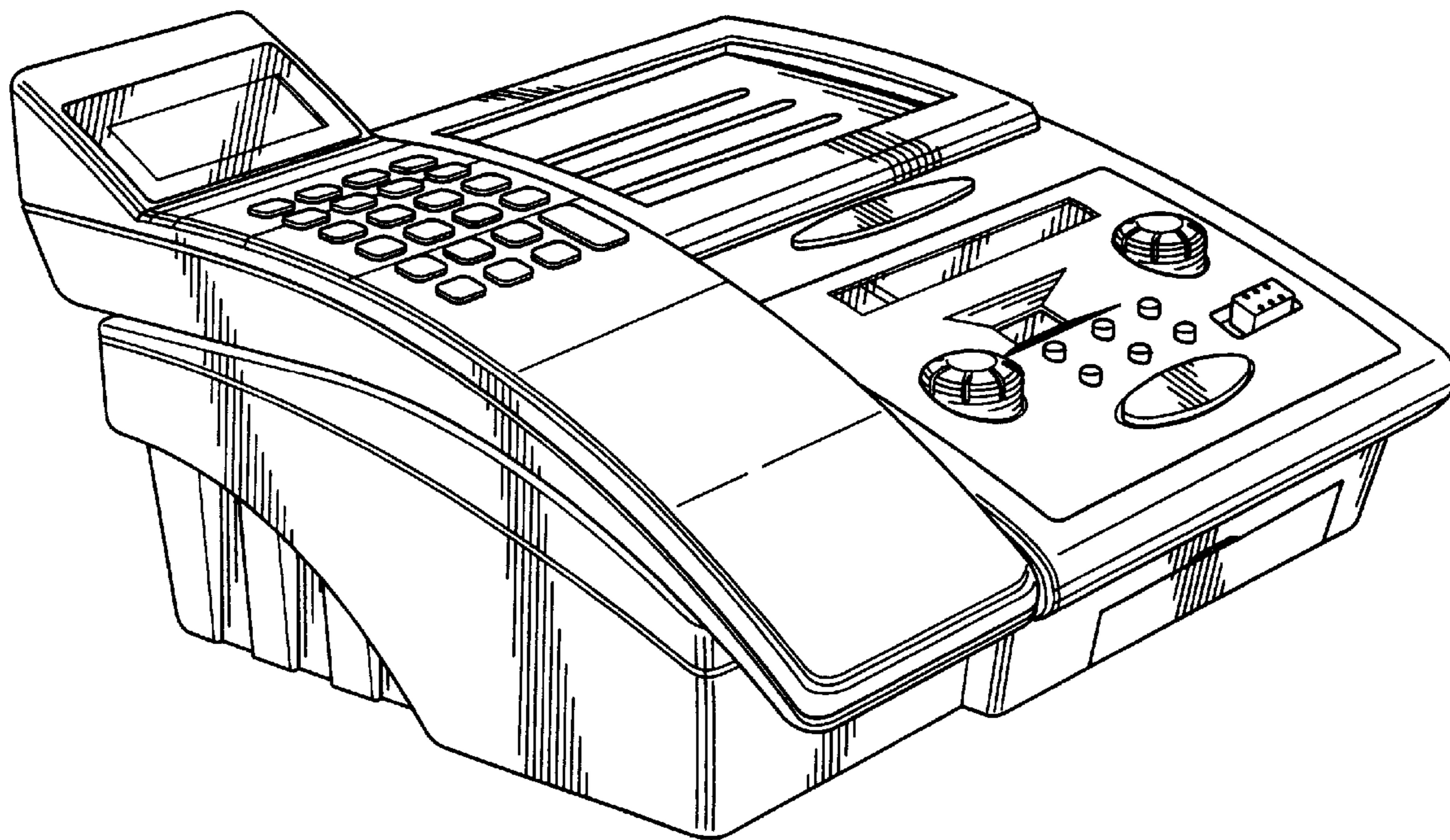

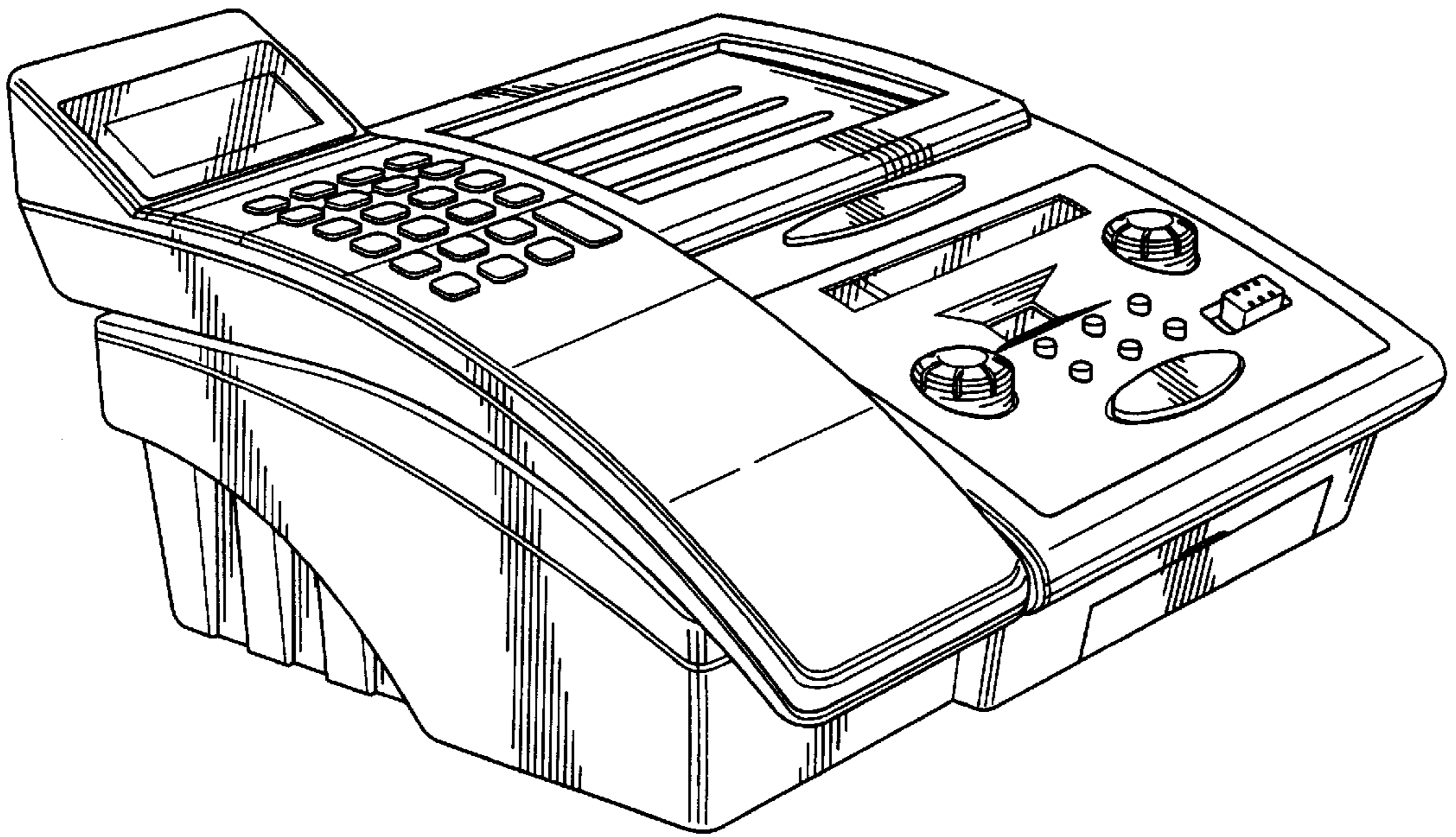

FIG. 1

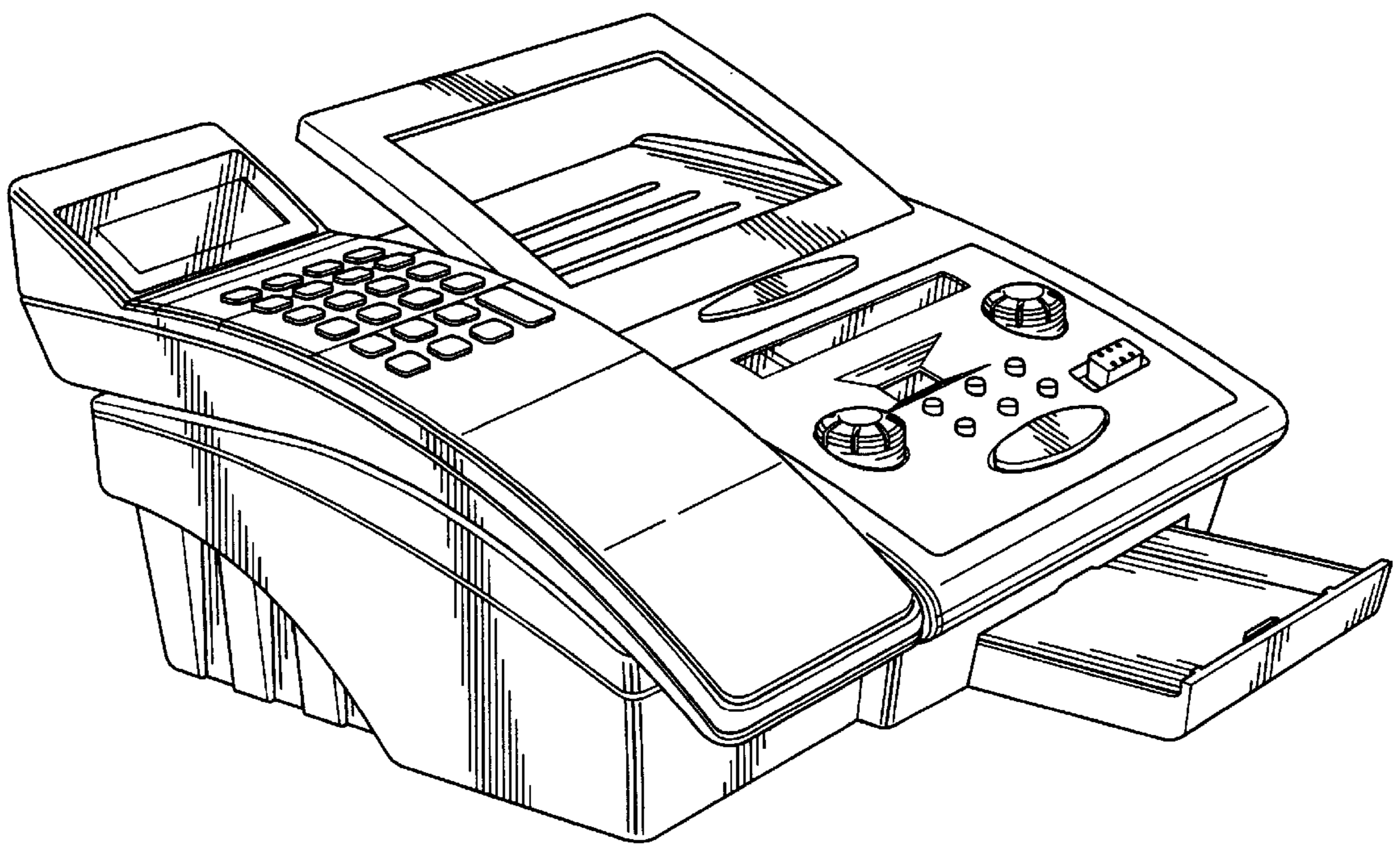

FIG. 2

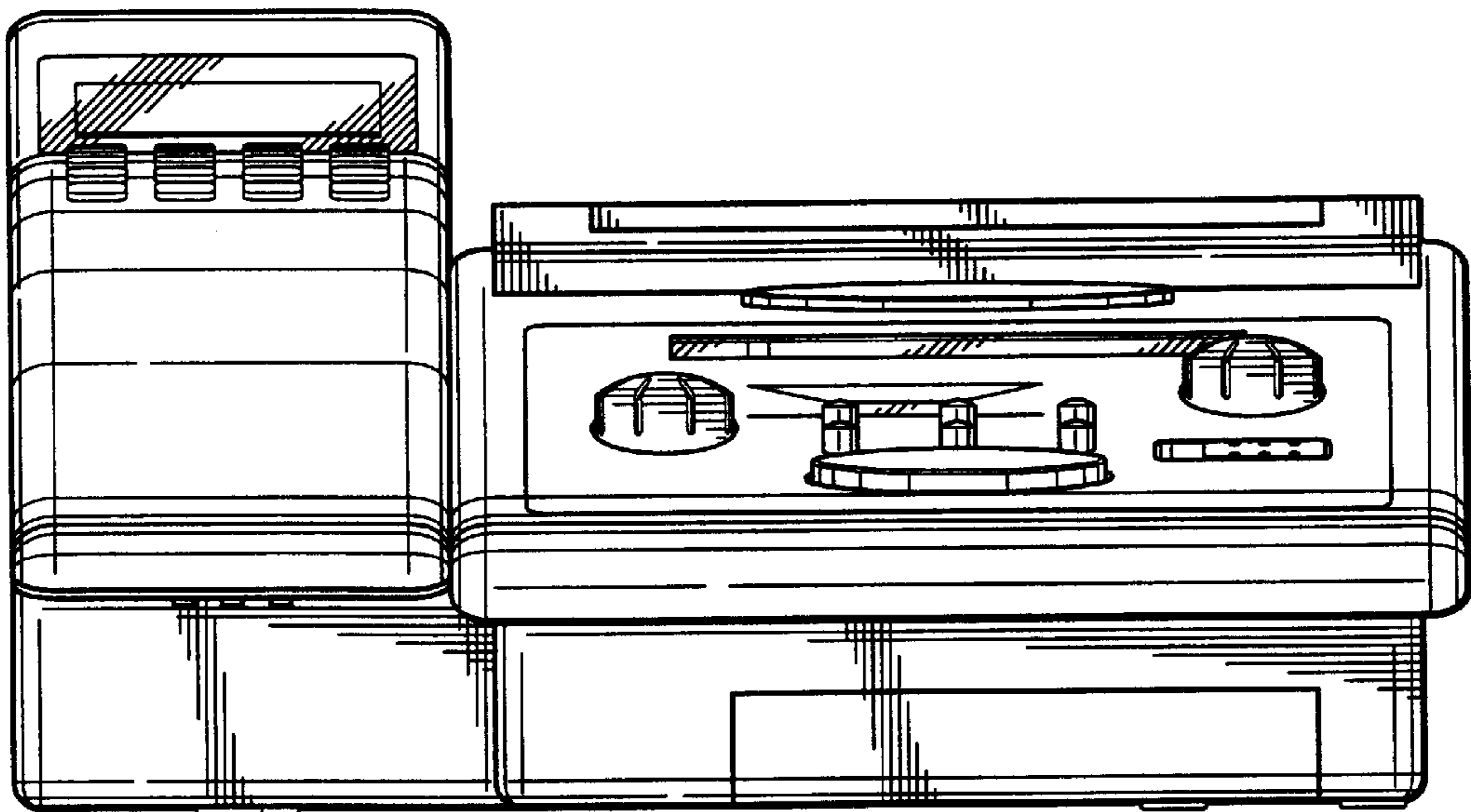

FIG. 3

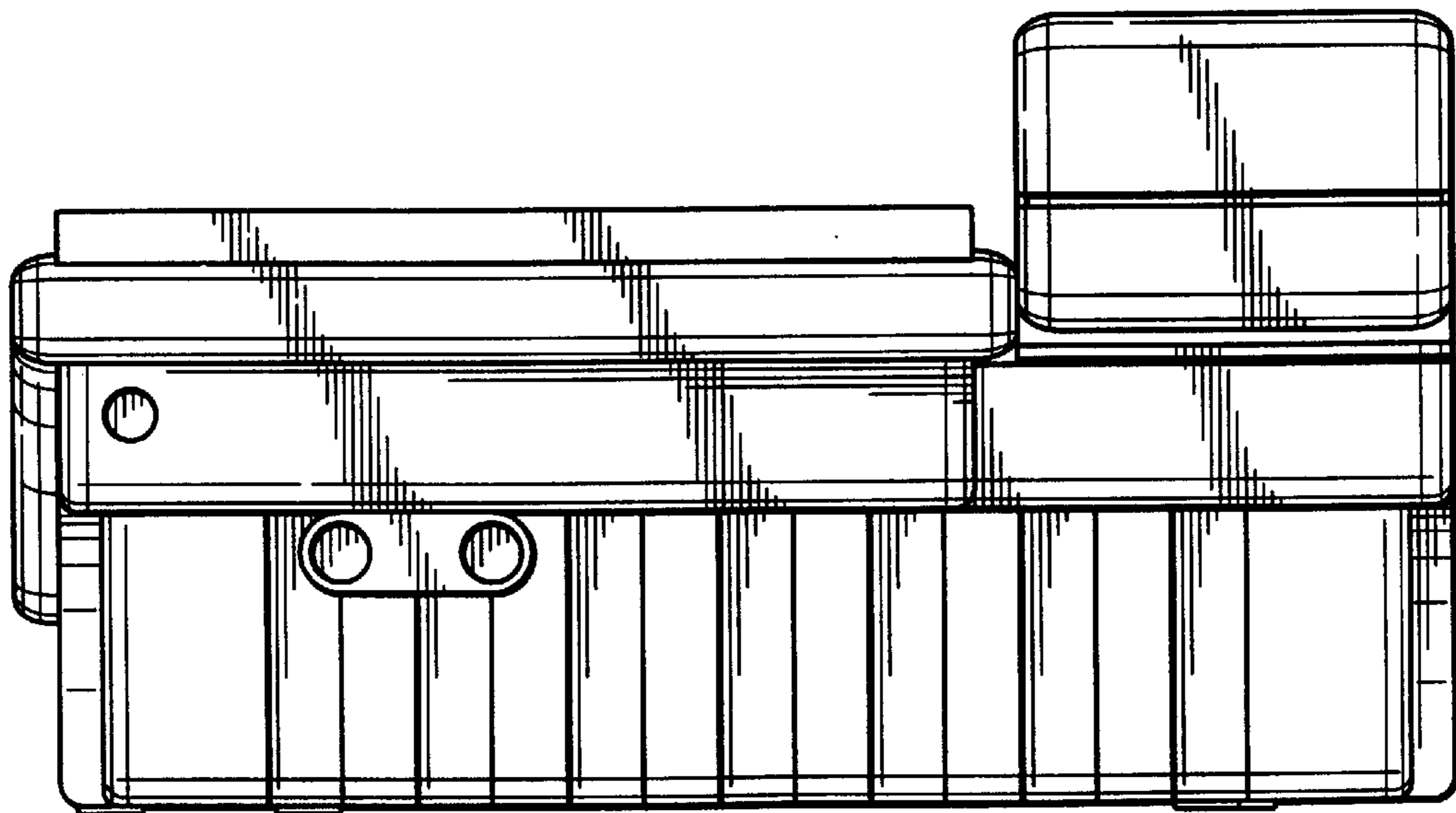

FIG. 6

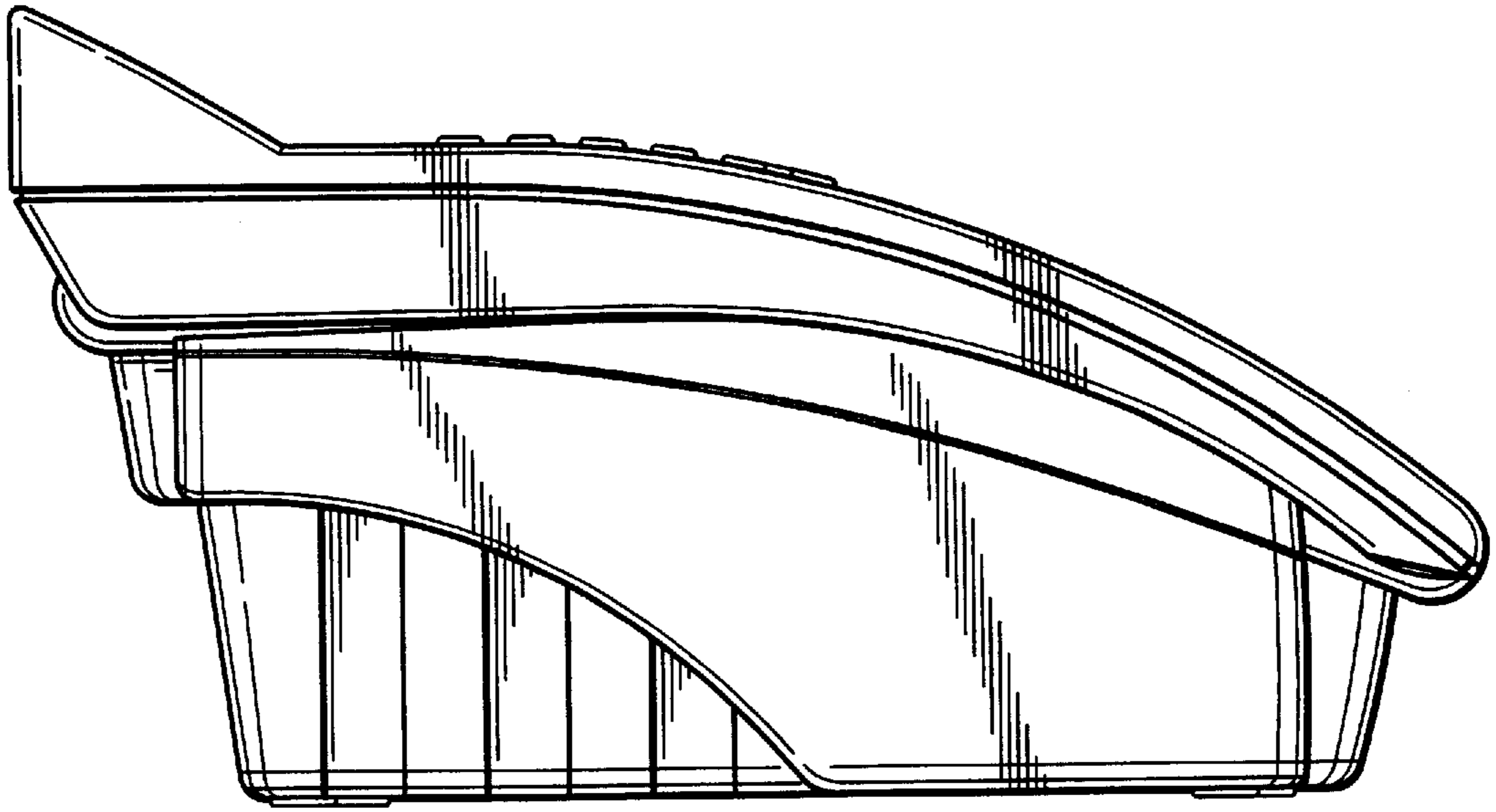

FIG. 4

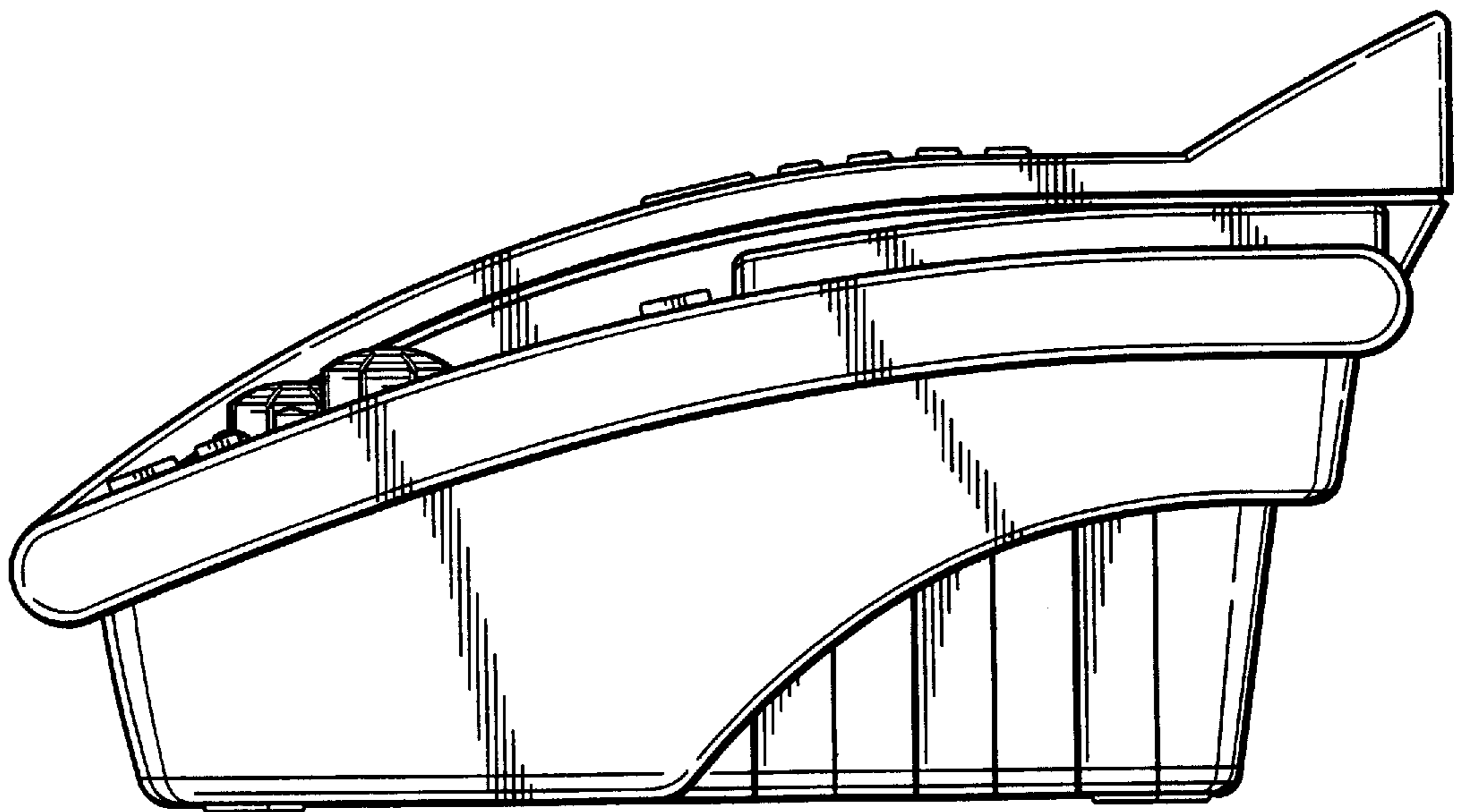

FIG. 5

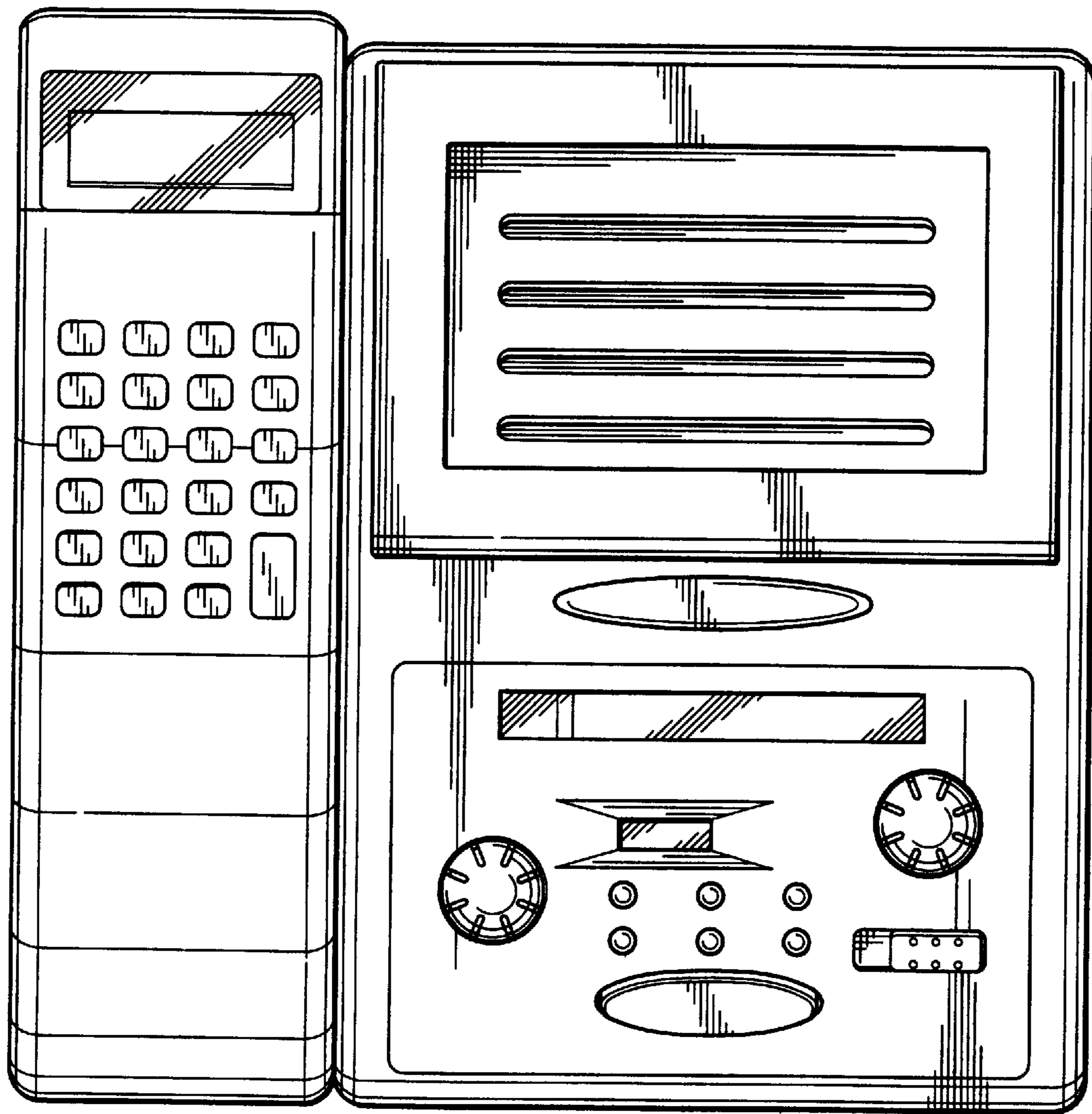

FIG. 7

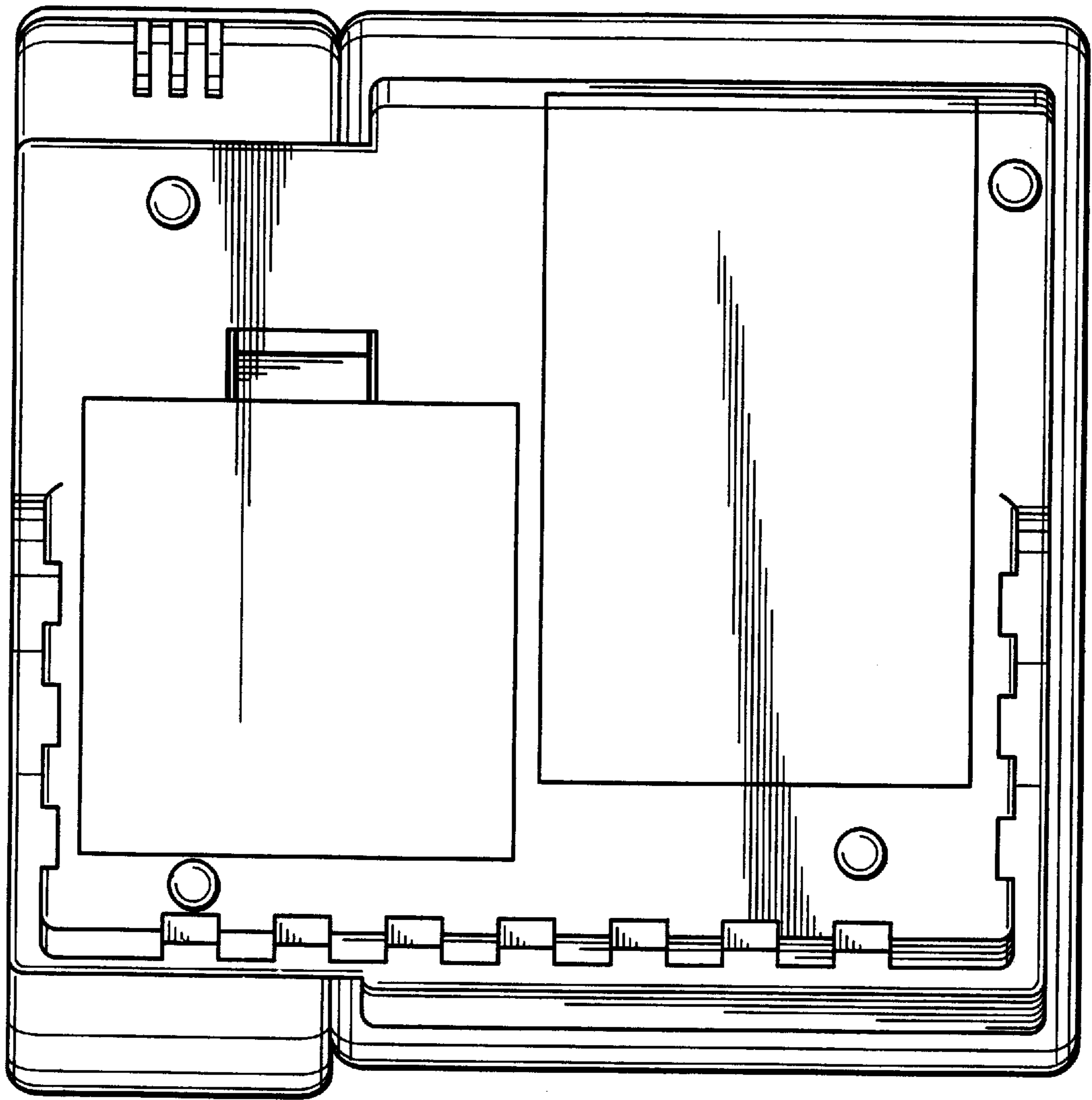

FIG. 8

UNITED STATES PATENT AND TRADEMARK OFFICE
CERTIFICATE OF CORRECTION

PATENT NO. : Des. 401,236
DATED : November 17, 1998
INVENTOR(S) : Tat-yin Fong

It is certified that error appears in the above-identified patent and that said Letters Patent is hereby corrected as shown below:

Title page, item [73] Assignee: Line 7, delete "Hong Kong"
(second occurrence).

In the Description, line 5, delete "lef-hand" and add -- left-hand --;
and
line 11, delete "clailmed" and add -- claimed --.

Signed and Sealed this
Sixth Day of April, 1999



Q. TODD DICKINSON

Attest:

Attesting Officer

Acting Commissioner of Patents and Trademarks