



US00D401184S

United States Patent [19]

[11] Patent Number: Des. 401,184

Tsukui et al.

[45] Date of Patent: **Nov. 17, 1998

[54] MOTORCYCLE

882956	11/1993	Japan .
894368	3/1994	Japan .
925470	5/1995	Japan .
925599	5/1995	Japan .
925604	5/1995	Japan .

[75] Inventors: **Hiroaki Tsukui; Tetsuya Nakazawa,**
both of Saitama, Japan

[73] Assignee: **Honda Giken Kogyo Kabushiki**
Kaisha, Tokyo, Japan

OTHER PUBLICATIONS

[**] Term: **14 Years**

Cycle World, The Shiver and Cagiva N1 motorcycles, pp. 24 & 25 Mar. 1996.

[21] Appl. No.: **61,356**

Primary Examiner—Melody N. Brown
Attorney, Agent, or Firm—Birch, Stewart, Kolasch & Birch, LLP

[22] Filed: **Oct. 22, 1996**

[30] Foreign Application Priority Data

Apr. 22, 1996 [JP] Japan 8-11673

[51] LOC (6) Cl. **12-11**

[52] U.S. Cl. **D12/110**

[58] Field of Search D12/110; 180/219

[57] CLAIM

The ornamental design for a motorcycle, as shown and described.

[56] References Cited

U.S. PATENT DOCUMENTS

D. 333,641	3/1993	Sakaguchi et al.	D12/110
D. 336,450	6/1993	Tsukui et al.	D12/110
D. 347,411	5/1994	Horii et al.	D12/110
D. 347,808	6/1994	Heinrich et al.	D12/110
D. 350,918	9/1994	Kohama et al.	D12/110
D. 350,920	9/1994	Tsukui et al.	D12/110

FOREIGN PATENT DOCUMENTS

849356 10/1992 Japan .

DESCRIPTION

FIG. 1 is a front left perspective view of a motorcycle showing our new design;
FIG. 2 is a front right perspective view thereof;
FIG. 3 is a rear left perspective view thereof;
FIG. 4 is a rear right perspective view thereof;
FIG. 5 is a front elevational view thereof;
FIG. 6 is a rear elevational view thereof;
FIG. 7 is a right side elevational view thereof;
FIG. 8 is a left side elevational view thereof;
FIG. 9 is a top plan view thereof; and,
FIG. 10 is a bottom plan view thereof.

1 Claim, 10 Drawing Sheets

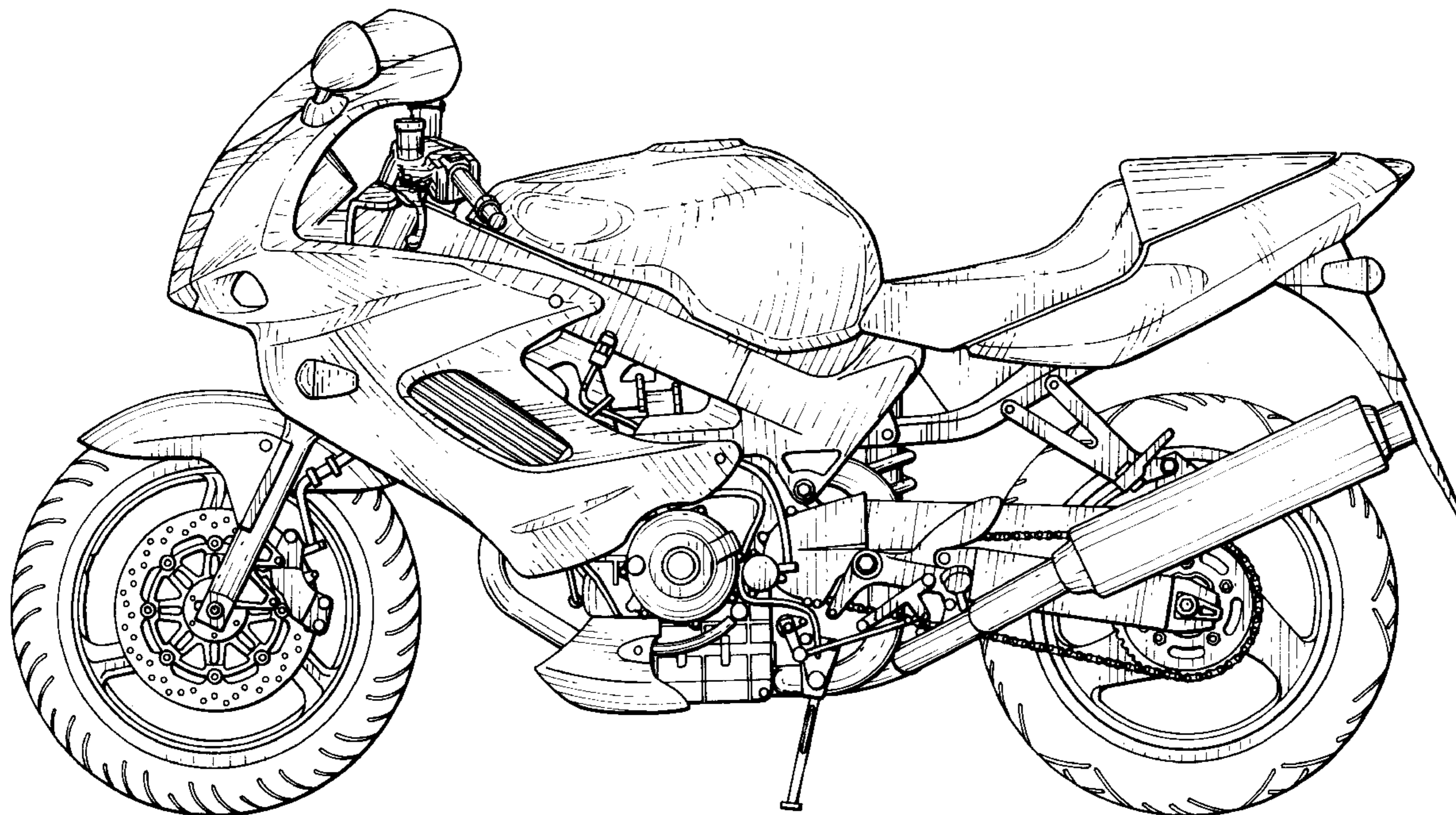

FIG. 1

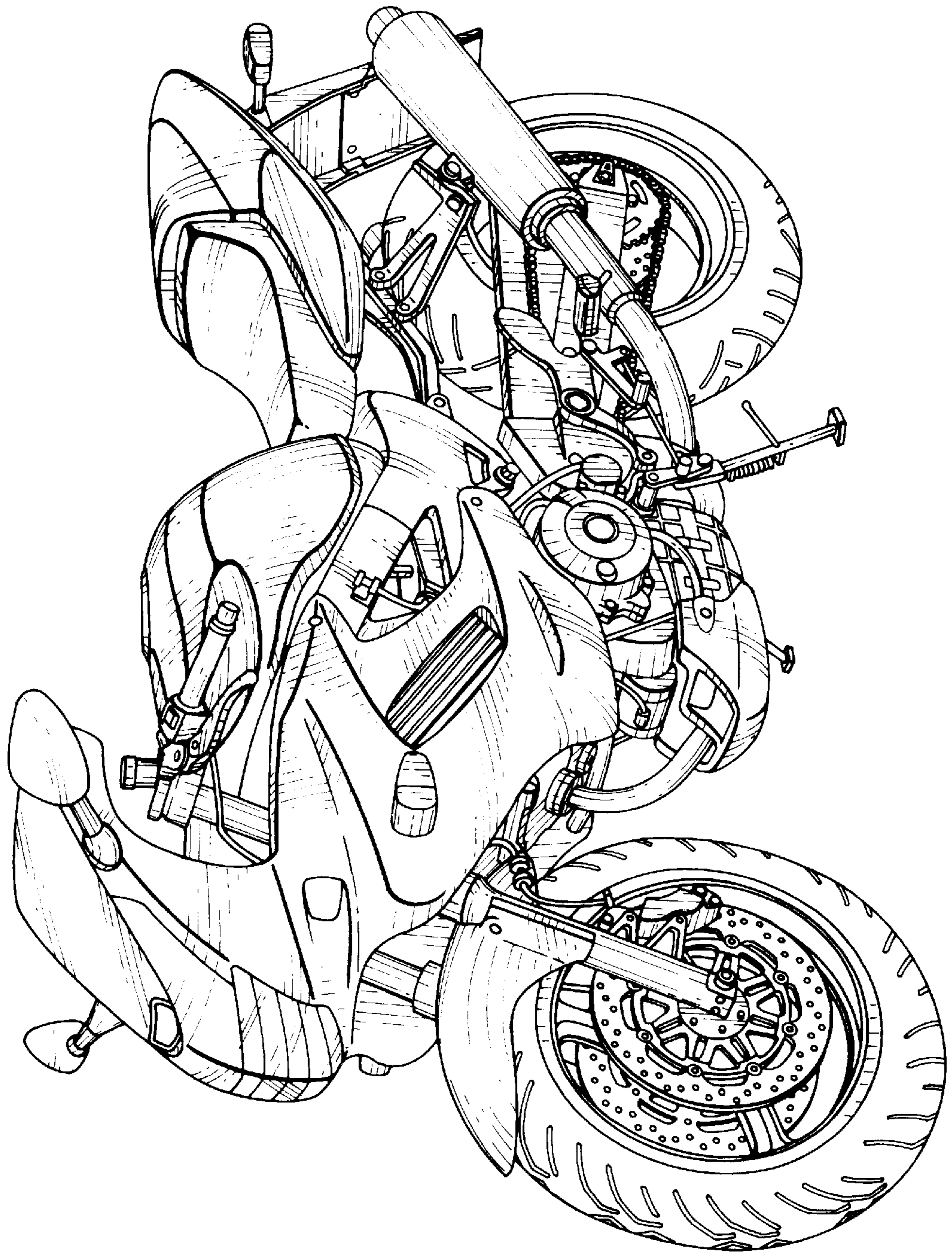

FIG. 2

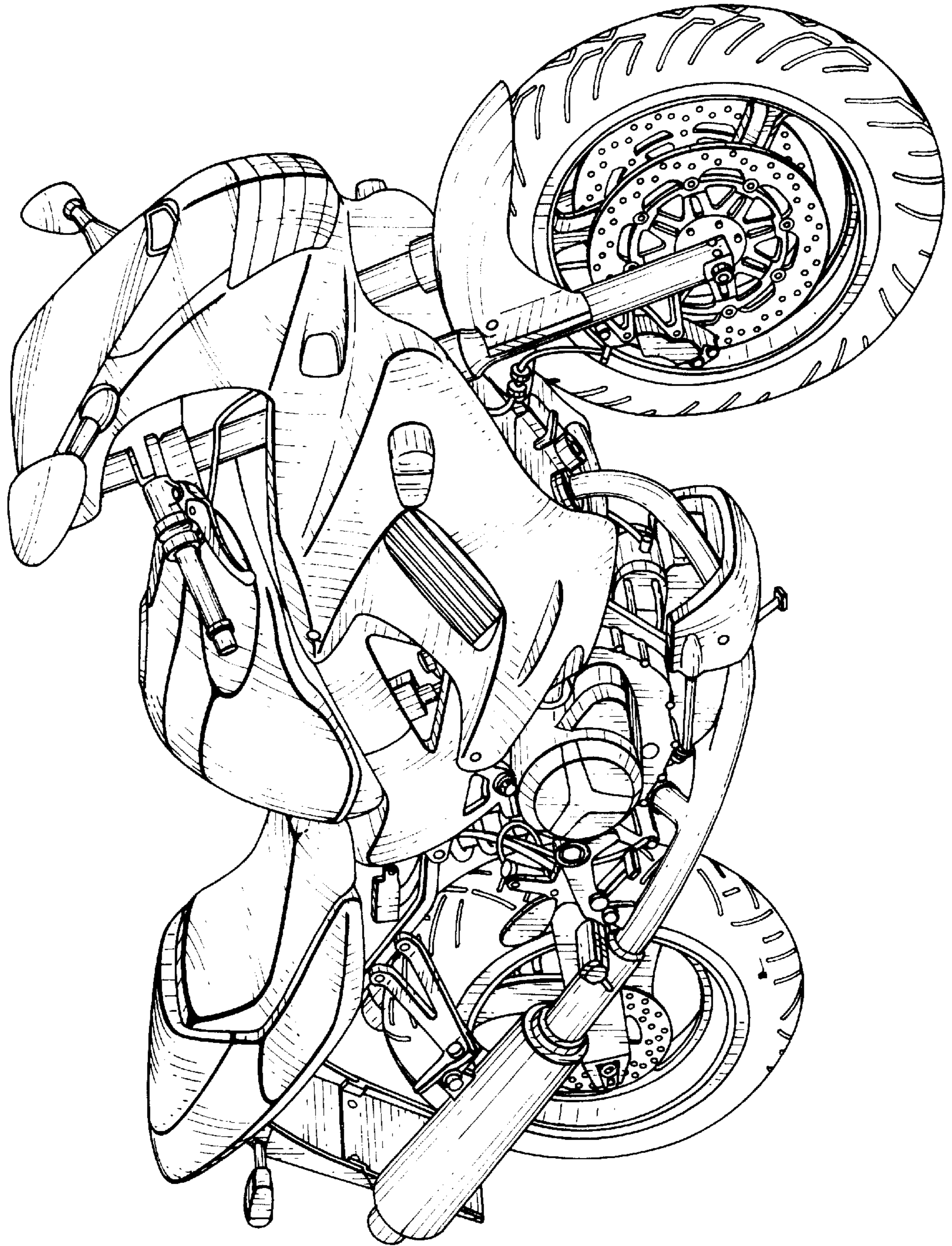

FIG. 3

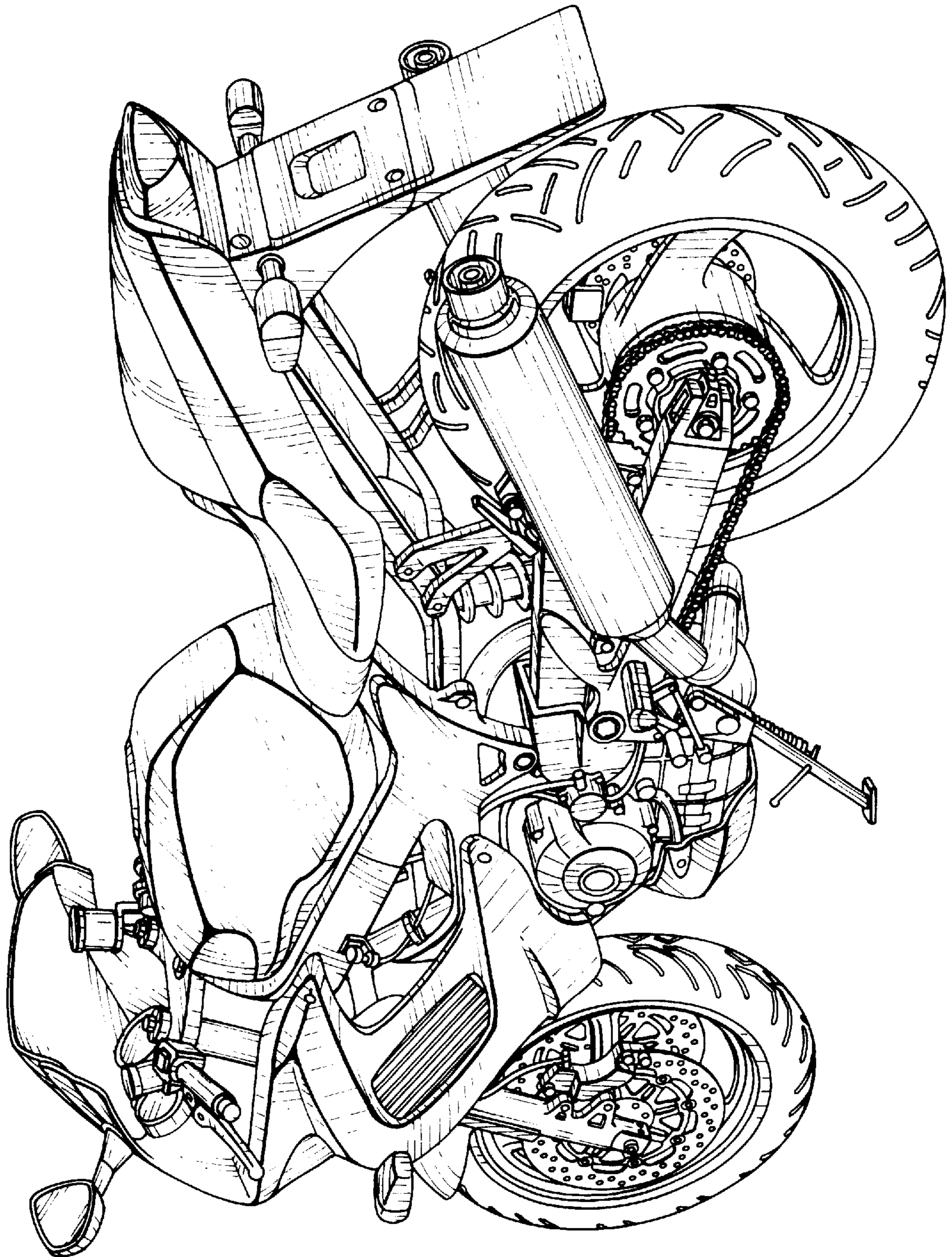

FIG. 4

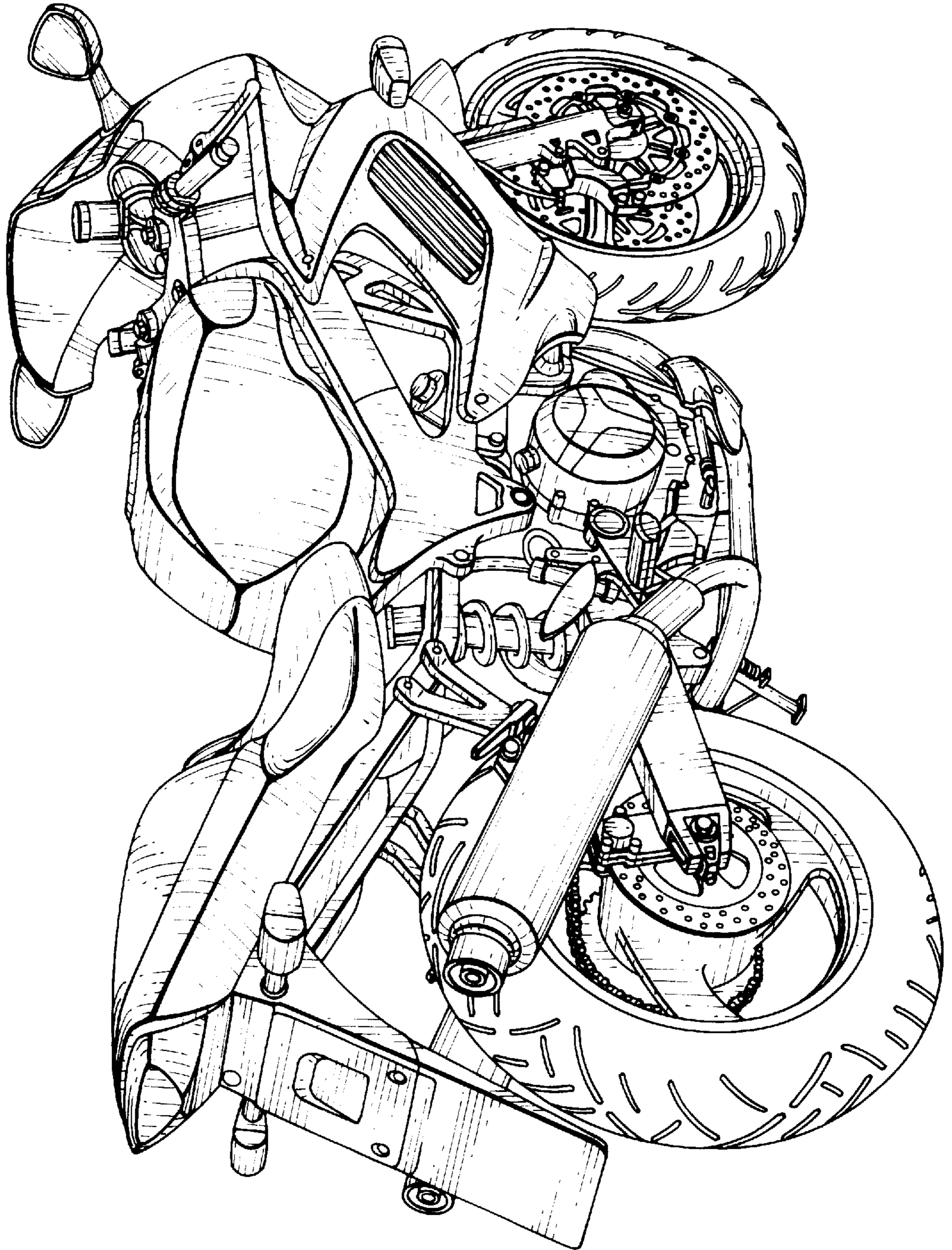

FIG. 5

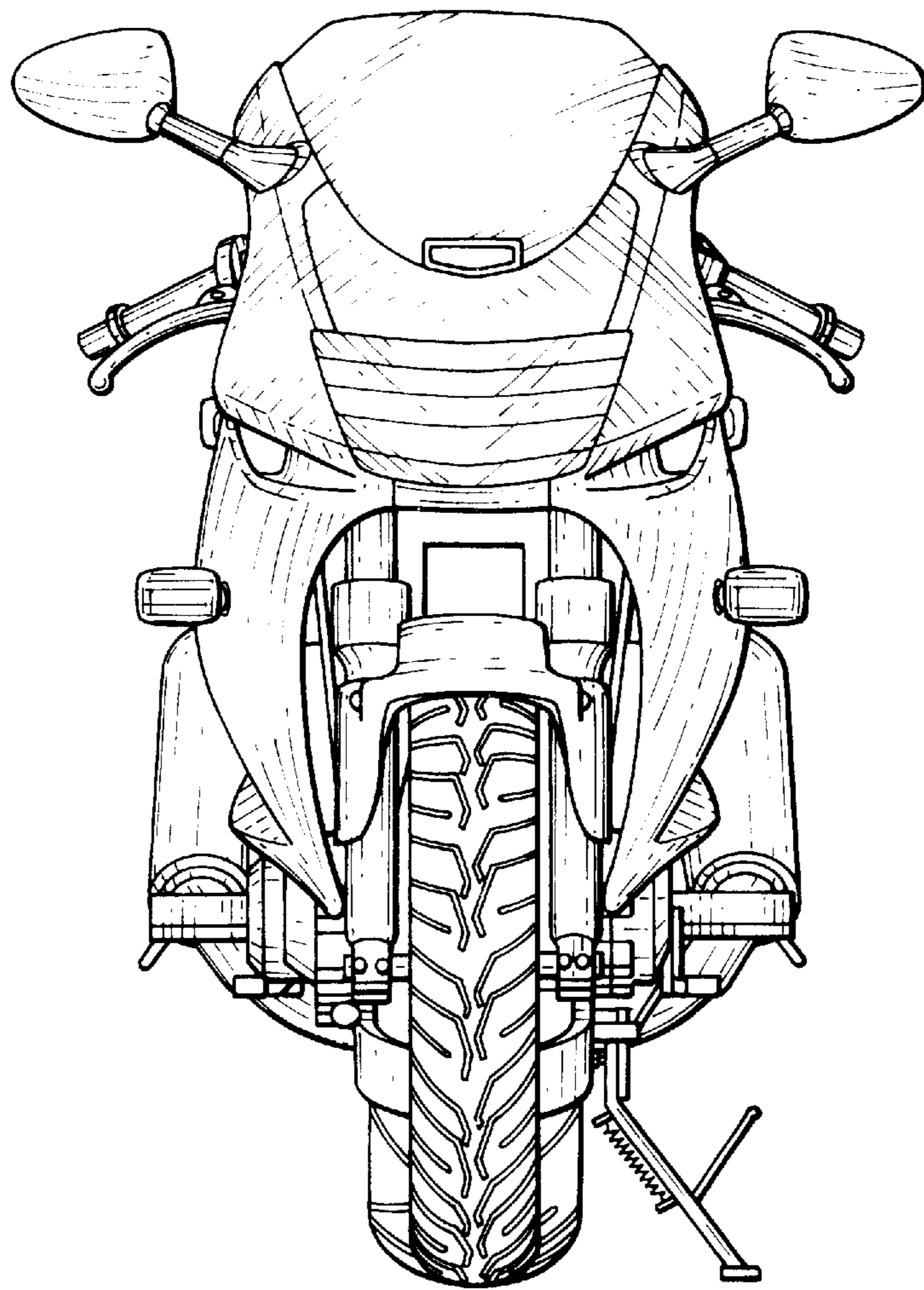

FIG. 6

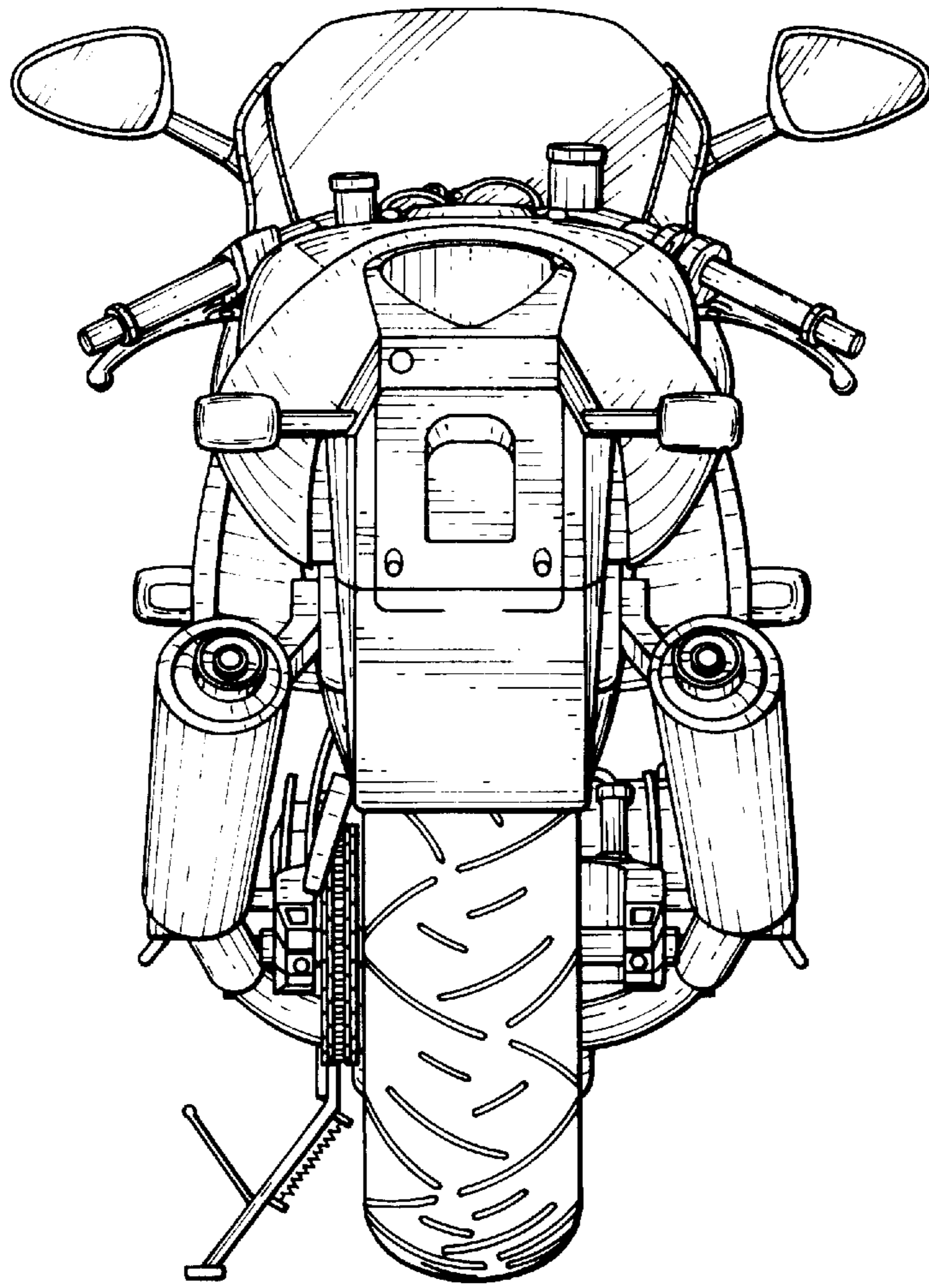

FIG. 7

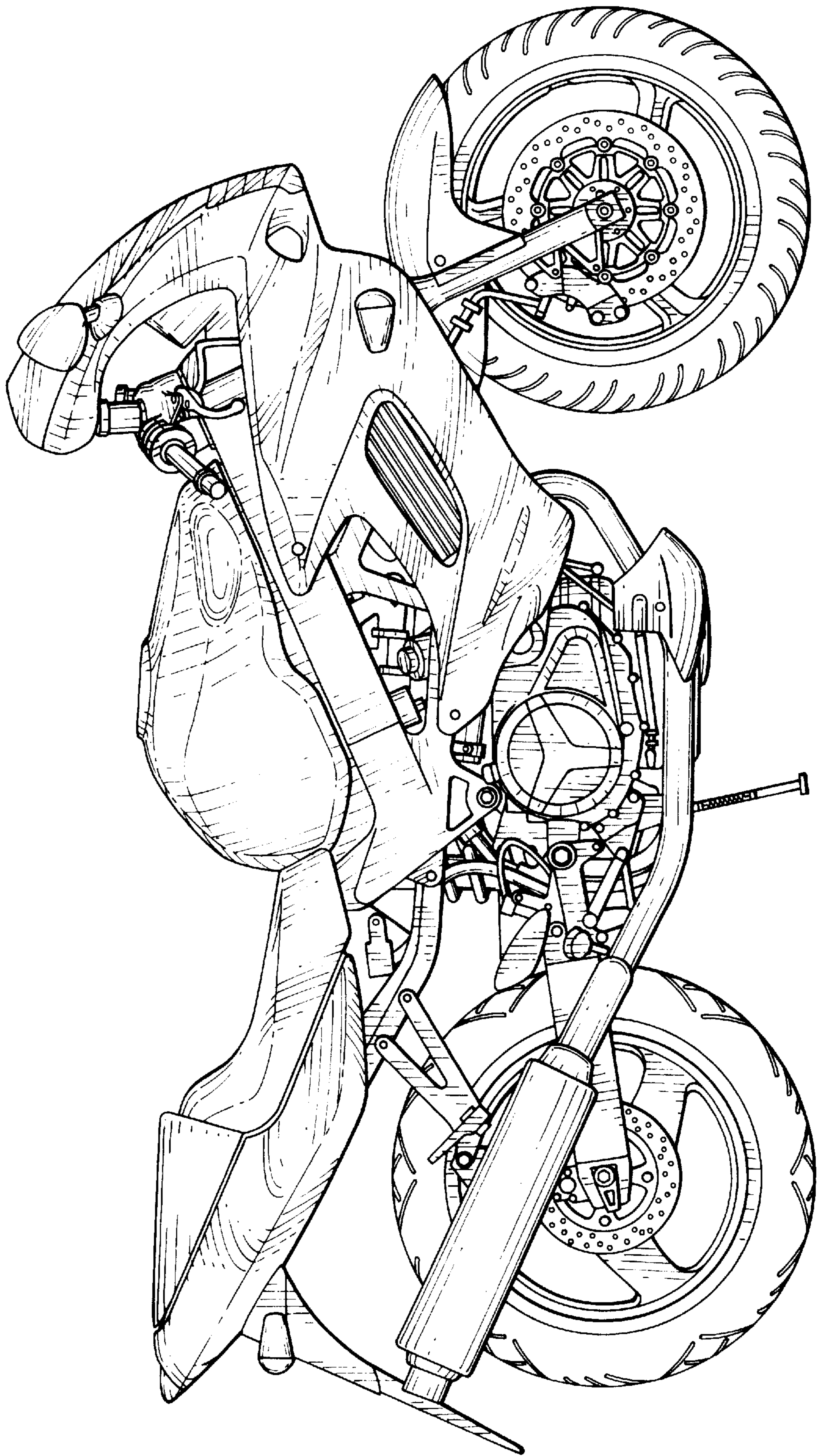

FIG. 8

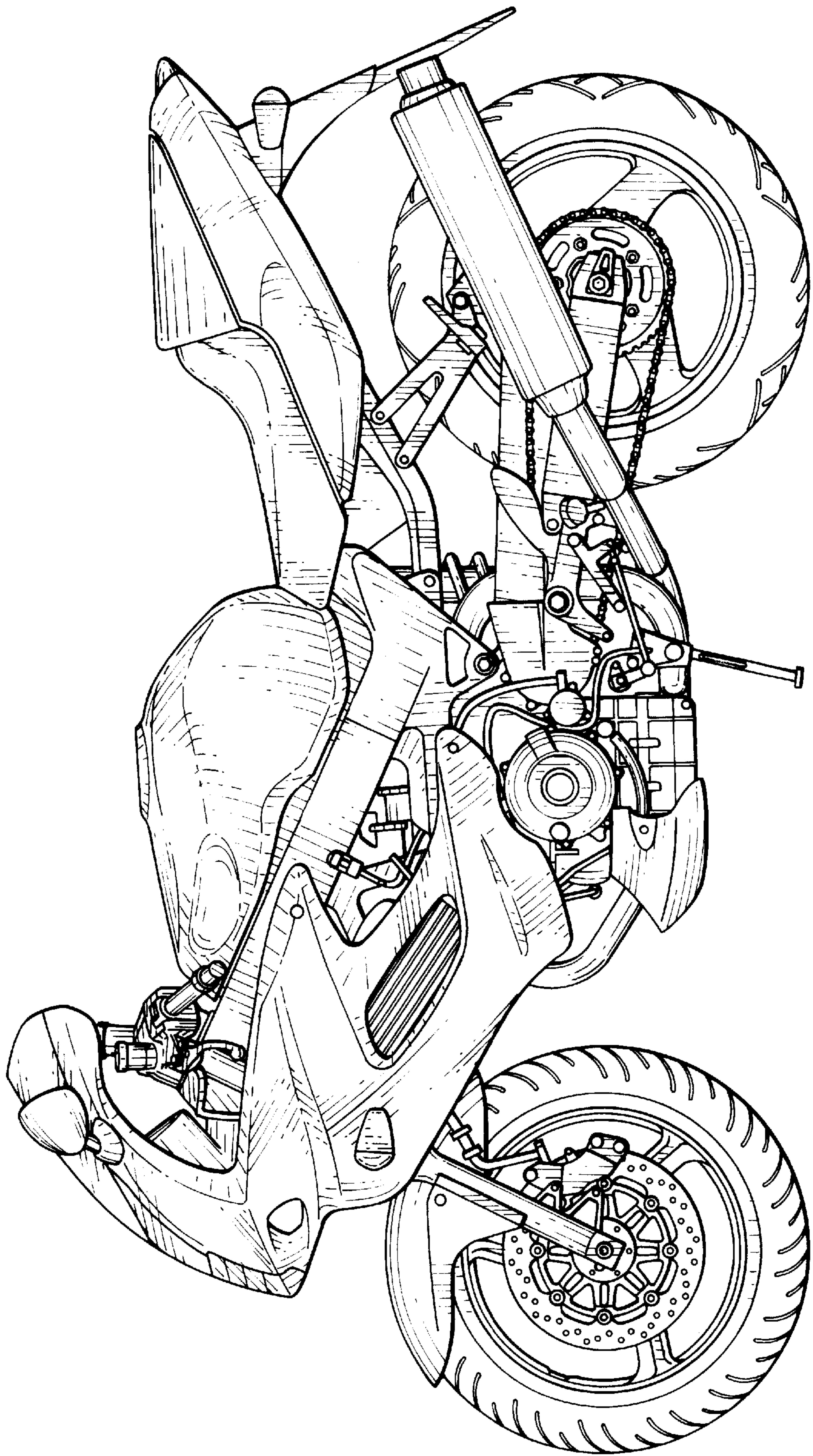
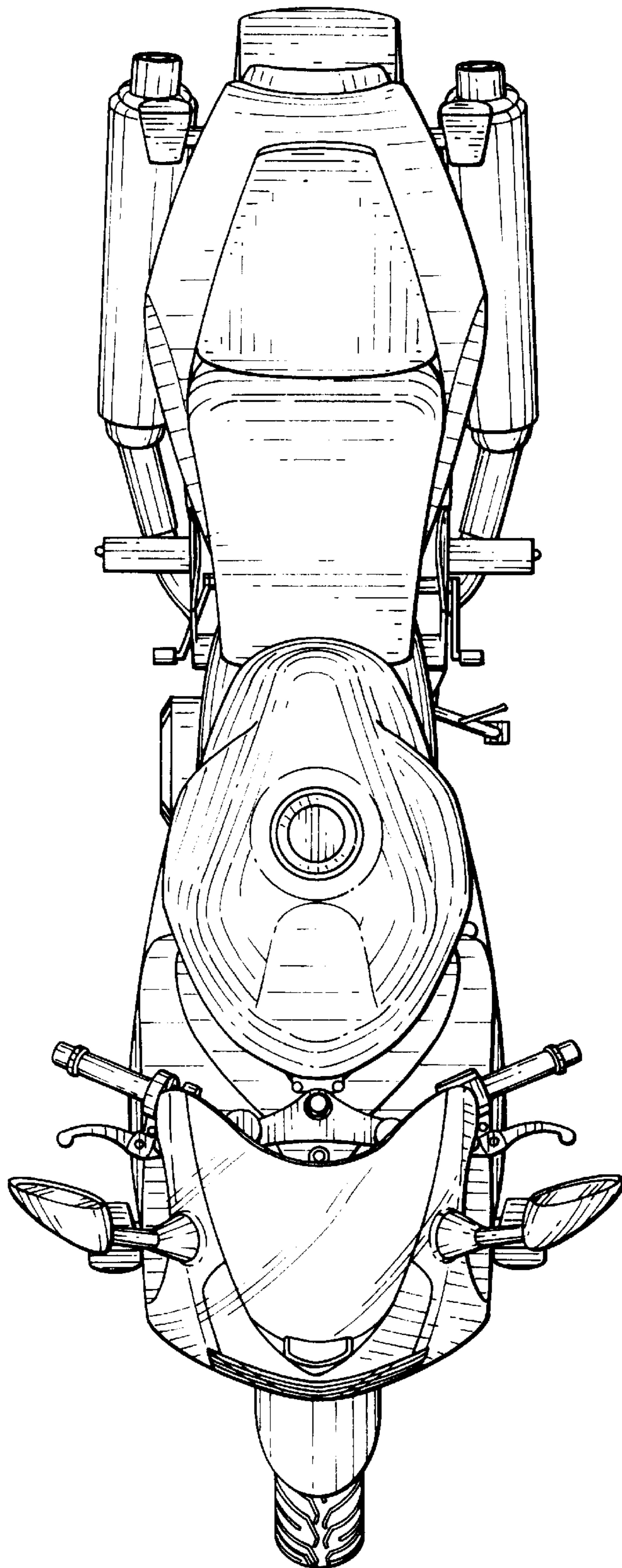

FIG. 9



F I G . 10

