



US00D401182S

United States Patent [19] Bulgari

[11] **Patent Number: Des. 401,182**

[45] **Date of Patent: **Nov. 17, 1998**

[54] **EARRING**

[75] Inventor: **Paolo Bulgari**, Rome, Italy

[73] Assignee: **Bulgari S.p.A.**, Rome, Italy

[**] Term: **14 Years**

[21] Appl. No.: **73,732**

[22] Filed: **Jul. 21, 1997**

[30] **Foreign Application Priority Data**

Apr. 21, 1997 [WO] WIPO DM/039923

[51] **LOC (6) Cl.** **11-01**

[52] **U.S. Cl.** **D11/41; D11/43; D11/76**

[58] **Field of Search** **D11/40-78; 63/20, 63/12, 4, 14.2, 3, 5.2, 33-34, 38, 21, 3.1**

[56] **References Cited**

U.S. PATENT DOCUMENTS

| | | | | |
|------------|---------|---------------|-------|--------|
| D. 20,008 | 7/1890 | Beach | | D11/77 |
| D. 38,369 | 9/1906 | Bulgari | | D11/40 |
| D. 136,600 | 11/1943 | Branfeld | | D11/76 |
| D. 176,957 | 2/1956 | Katz | | D11/76 |
| D. 181,208 | 10/1957 | Lemons et al. | | D11/76 |

| | | | | |
|------------|---------|--------------------|-------|--------|
| D. 267,241 | 12/1982 | Bulgari | | D11/75 |
| D. 274,709 | 7/1984 | Bulgari | | D11/75 |
| D. 279,082 | 6/1985 | Bulgari | | D11/76 |
| D. 293,899 | 1/1988 | Bulgari | | D11/75 |
| D. 313,202 | 12/1990 | Bulgari | | D11/42 |
| D. 383,700 | 9/1997 | Bulgari | | D11/43 |
| 1,412,731 | 4/1922 | Wormser | | 63/3.1 |
| 5,505,061 | 4/1996 | Fleury, Jr. et al. | | D11/43 |
| 5,577,396 | 11/1996 | Cannon | | 63/12 |

Primary Examiner—Cathy Anne MacCormac
Attorney, Agent, or Firm—Barnes, Kisselle, Raisch, Choate, Whittemore & Hulbert, PC

[57] **CLAIM**

The ornamental design for an earring, as disclosed and shown.

DESCRIPTION

FIG. 1 is a front view;
FIG. 2 is a left side view;
FIG. 3 is a rear view;
FIG. 4 is a right side view;
FIG. 5 is a bottom view;
FIG. 6 is a top view; and,
FIG. 7 is a perspective view.

1 Claim, 1 Drawing Sheet



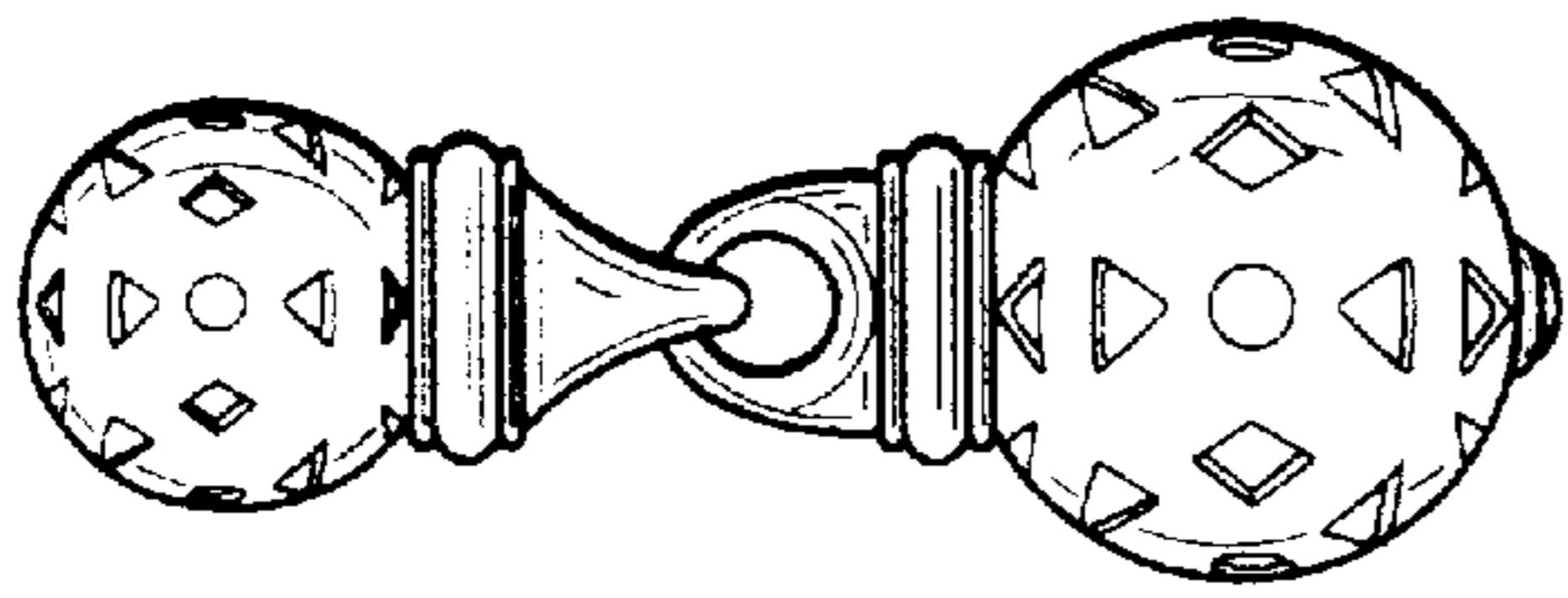

FIG. 1

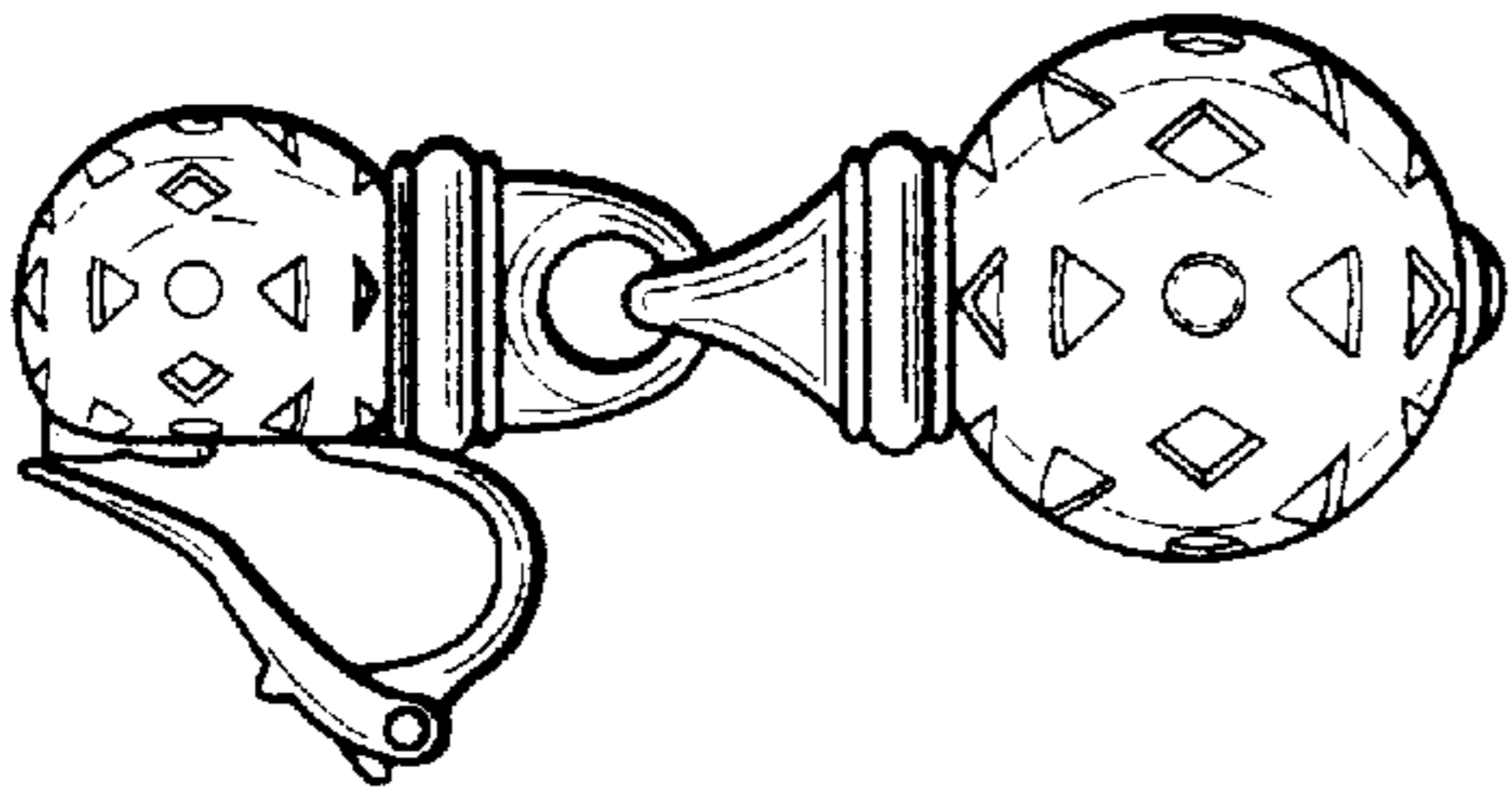

FIG. 2

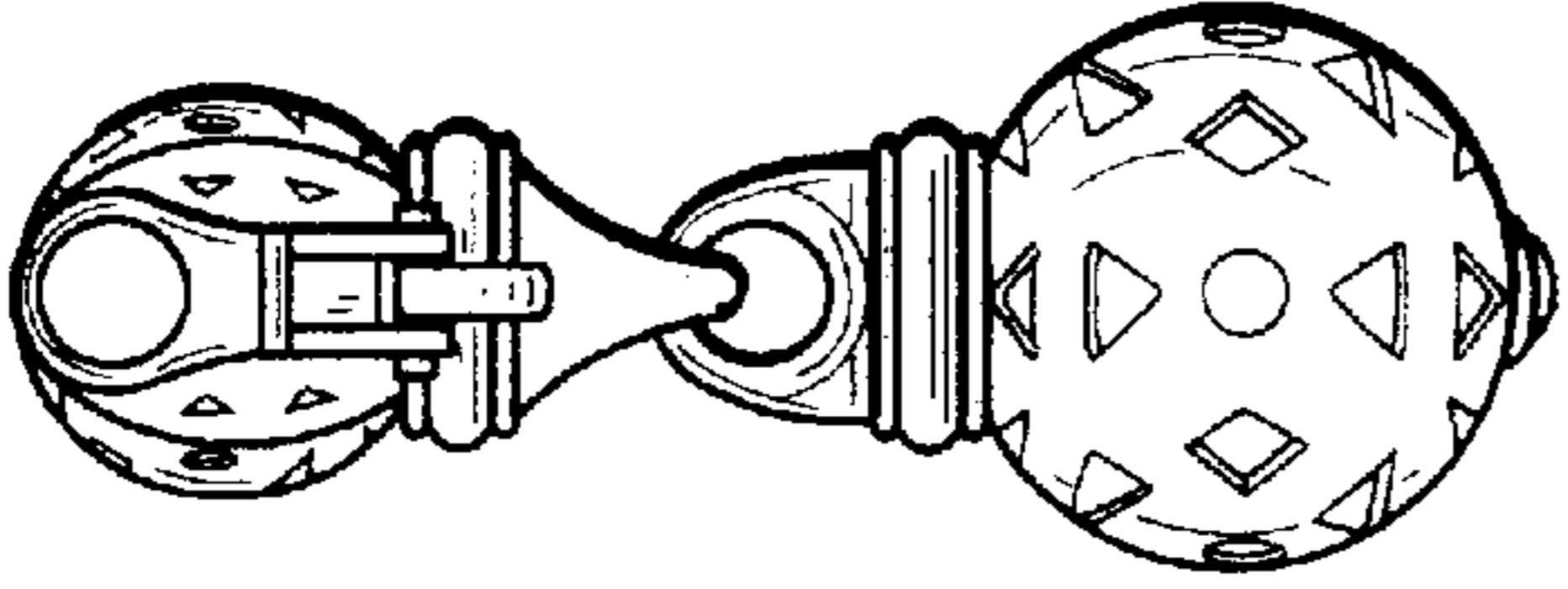

FIG. 3

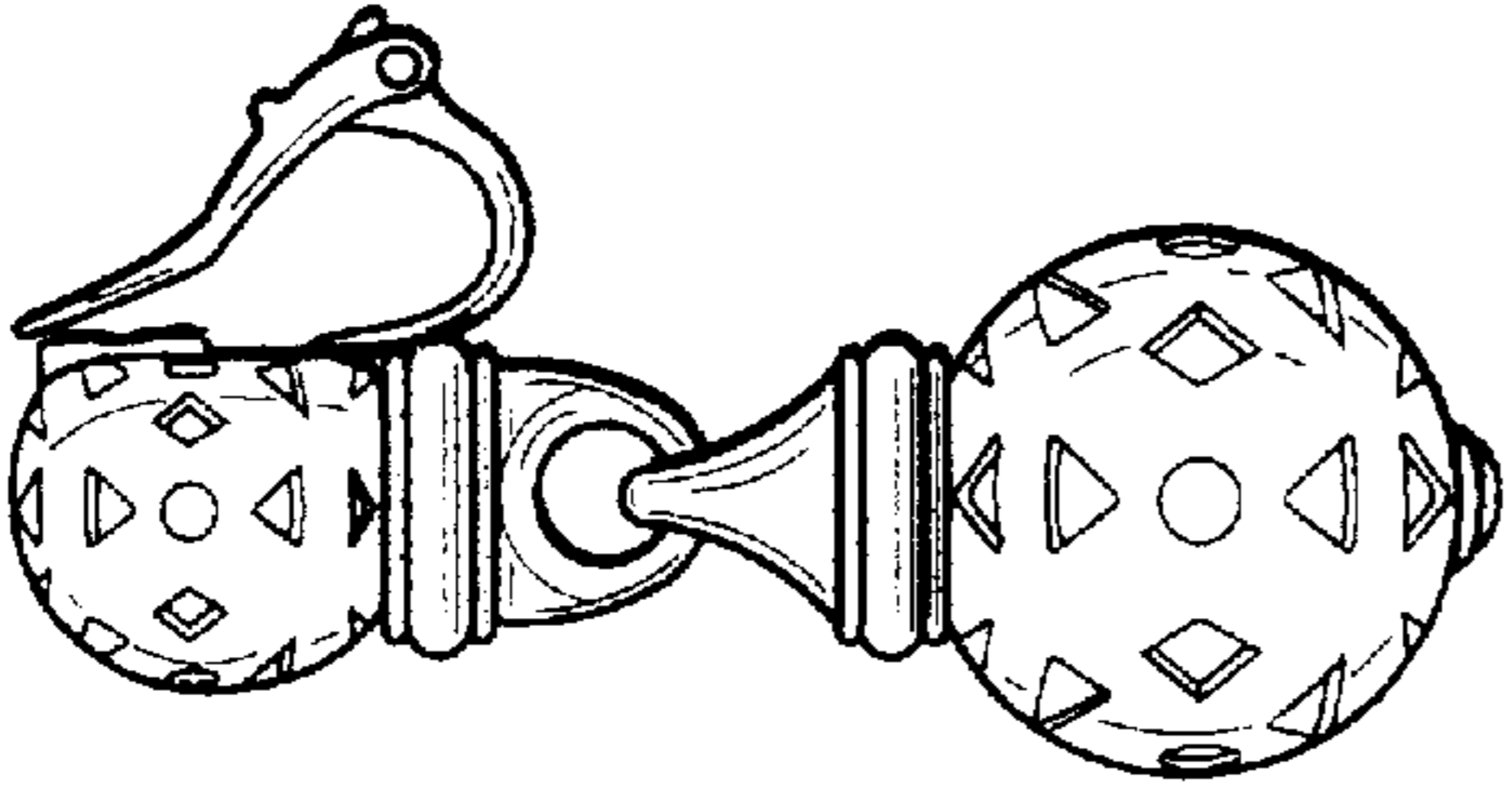

FIG. 4

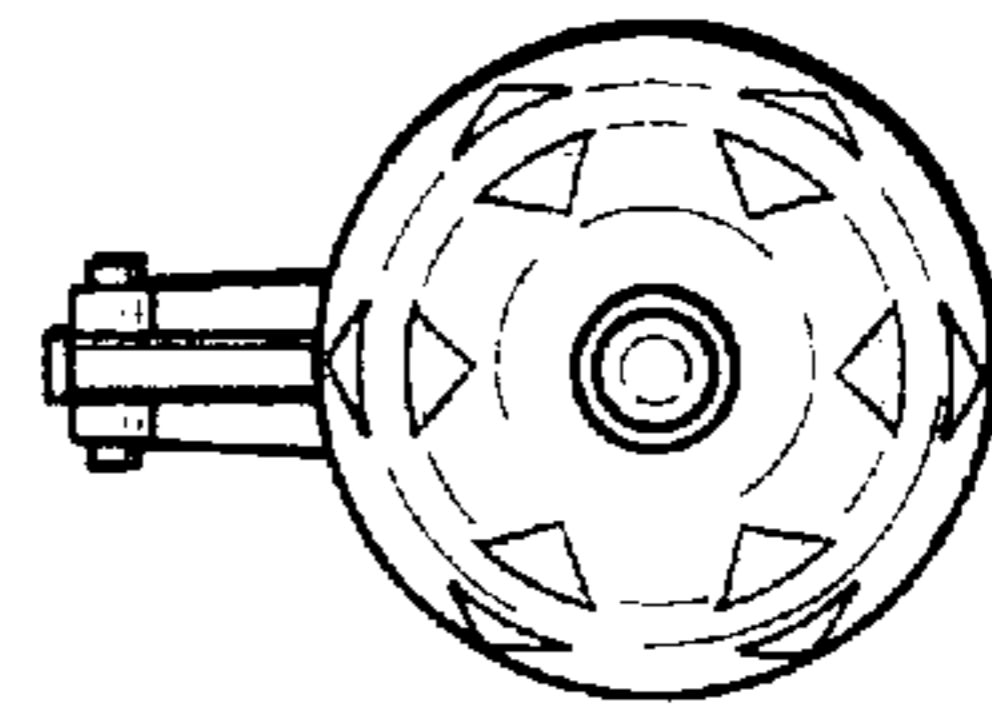

FIG. 5

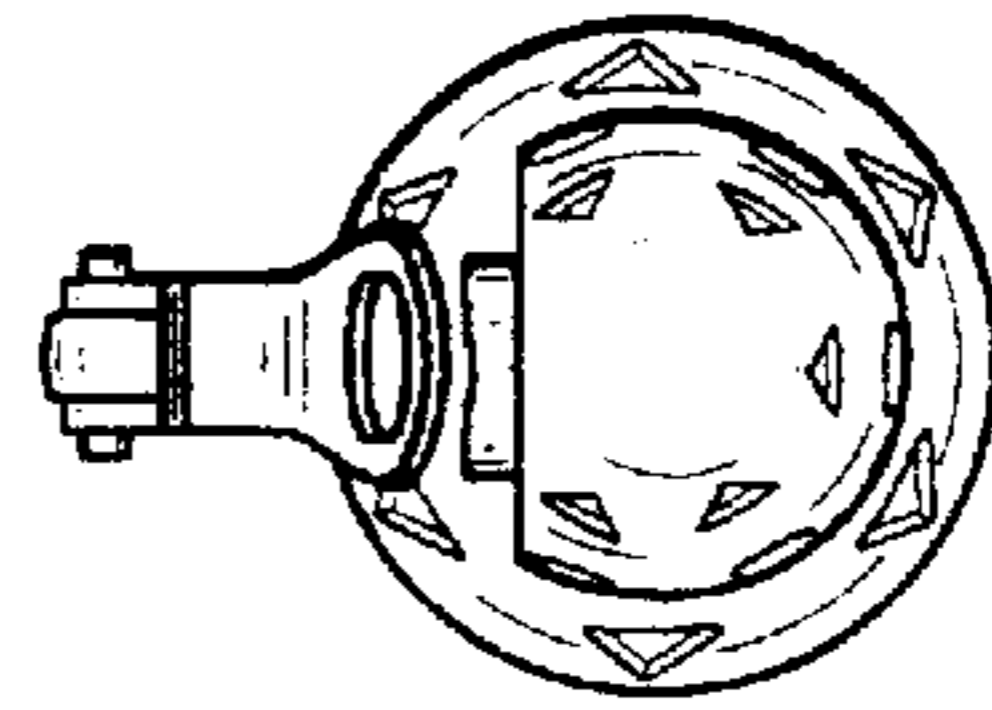

FIG. 6

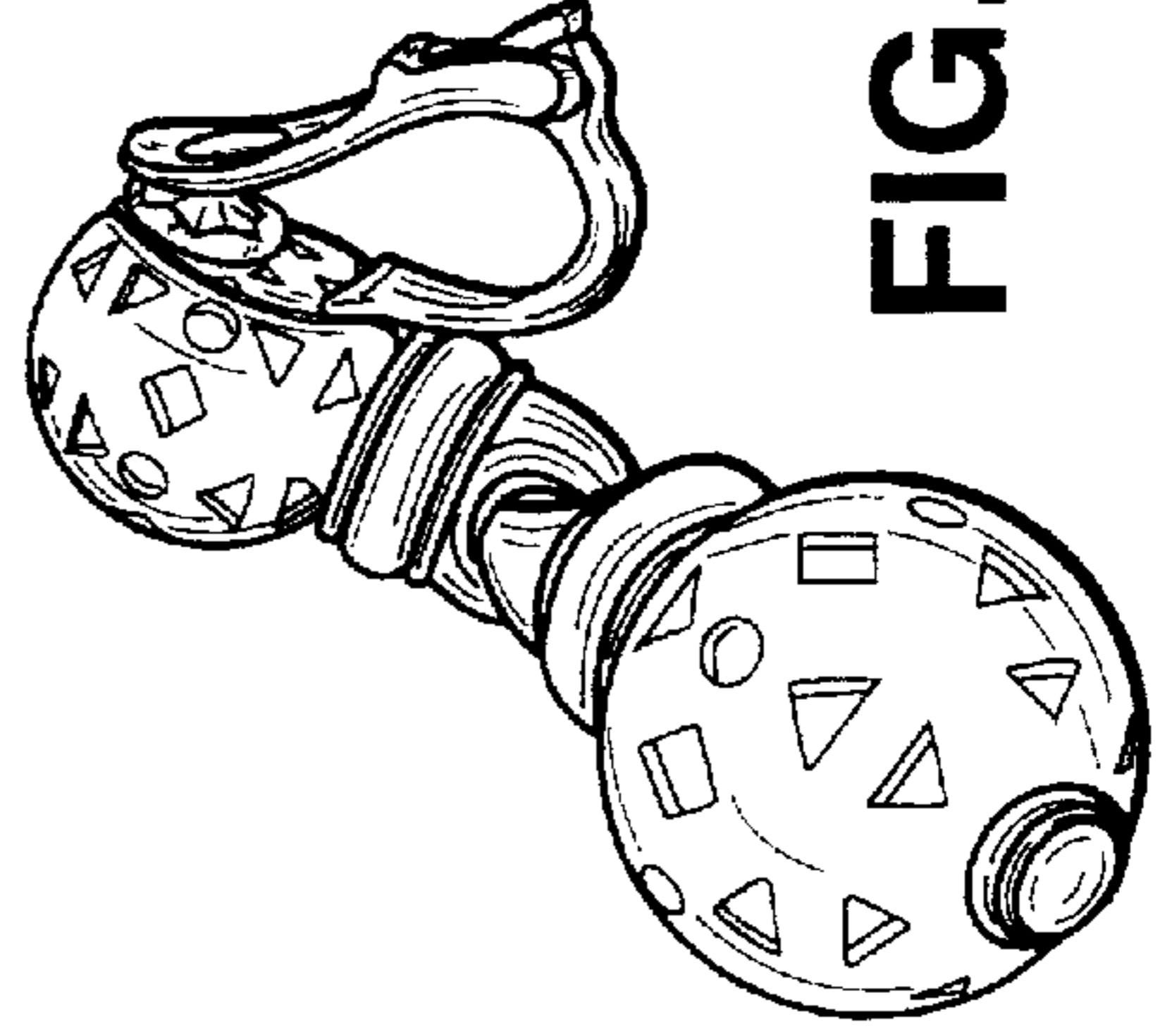

FIG. 7