



US00D401131S

# United States Patent [19]

Miyamoto et al.

[11] Patent Number: **Des. 401,131**

[45] Date of Patent: **\*\*Nov. 17, 1998**

[54] **ELECTRIC TAPE TRIMMING DEVICE**

[75] Inventors: **Masafumi Miyamoto**, Ishikawa-ken;  
**Kenji Watanabe**, Tokyo; **Takanobu Kameda**, Tokyo; **Tomoyuki Shimmura**, Tokyo, all of Japan

[73] Assignee: **King Jim Co., Ltd.**, Tokyo, Japan

[\*\*] Term: **14 Years**

[21] Appl. No.: **63,218**

[22] Filed: **Dec. 2, 1996**

[30] **Foreign Application Priority Data**

Aug. 9, 1996 [JP] Japan ..... 8-23835

[51] **LOC (6) Cl.** ..... **08-03**

[52] **U.S. Cl.** ..... **D8/98; D19/68; D19/65; D15/127**

[58] **Field of Search** ..... D19/65, 67, 68, D19/69, 72, 95, 99, 100; 225/6, 7, 19, 24, 25, 34, 45, 56, 65, 77, 89, 93; 83/39, 438, 440, 442, 298, 337; D8/98, 70.1

[56] **References Cited**

**U.S. PATENT DOCUMENTS**

- D. 144,687 5/1946 Briskin ..... D8/70.1
- D. 154,715 8/1949 Sigoda ..... D15/138
- D. 157,105 1/1950 Unsinger ..... D8/98
- D. 217,801 6/1970 Johnston et al. .... D8/98
- D. 232,056 7/1974 Kondo ..... D19/68

- D. 308,386 6/1990 Munson et al. .... D15/127
- D. 321,907 11/1991 Matsuno ..... D19/65 X
- 4,213,363 7/1980 Granger ..... 83/298
- 4,404,880 9/1983 DeLuca ..... 83/337 X
- 5,562,008 10/1996 Lordo ..... 83/39

**OTHER PUBLICATIONS**

Catalog sheet showing device of the present invention, published by King Jim Co., Ltd., Tokyo, Japan, Aug. 12, 1996.

*Primary Examiner*—Martie K. Holtje  
*Attorney, Agent, or Firm*—Frishauf, Holtz, Goodman, Langer & Chick

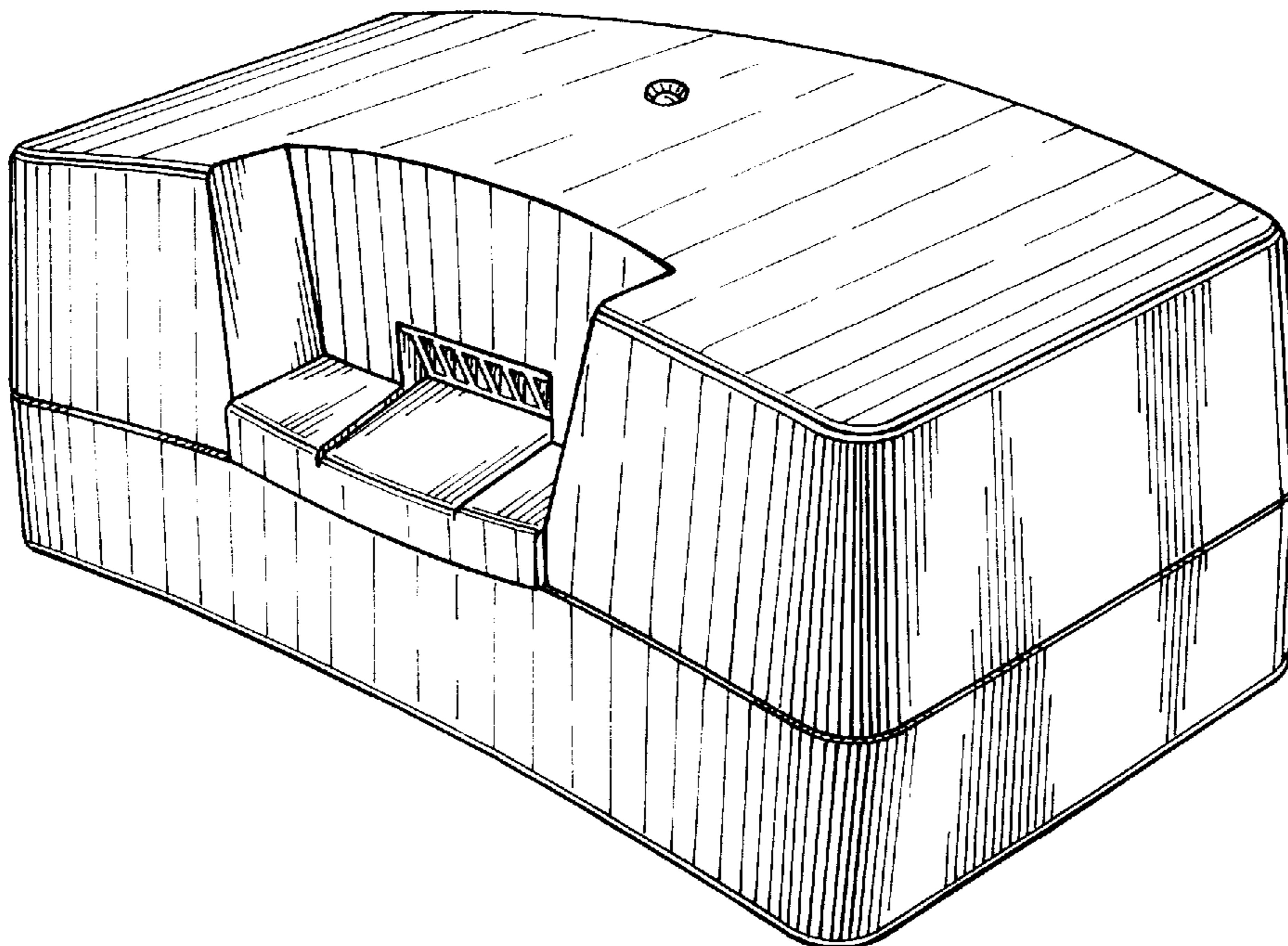
[57] **CLAIM**

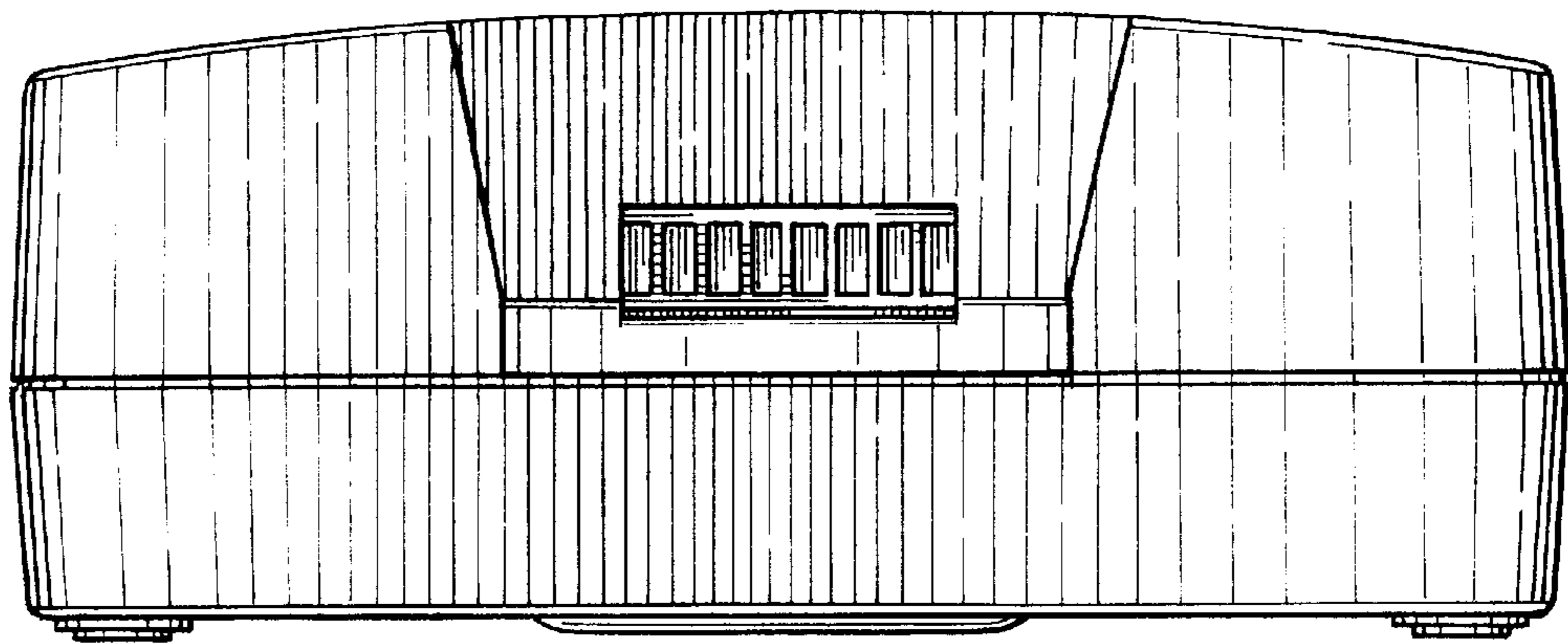
The ornamental design for an electric tape trimming device, as shown.

**DESCRIPTION**

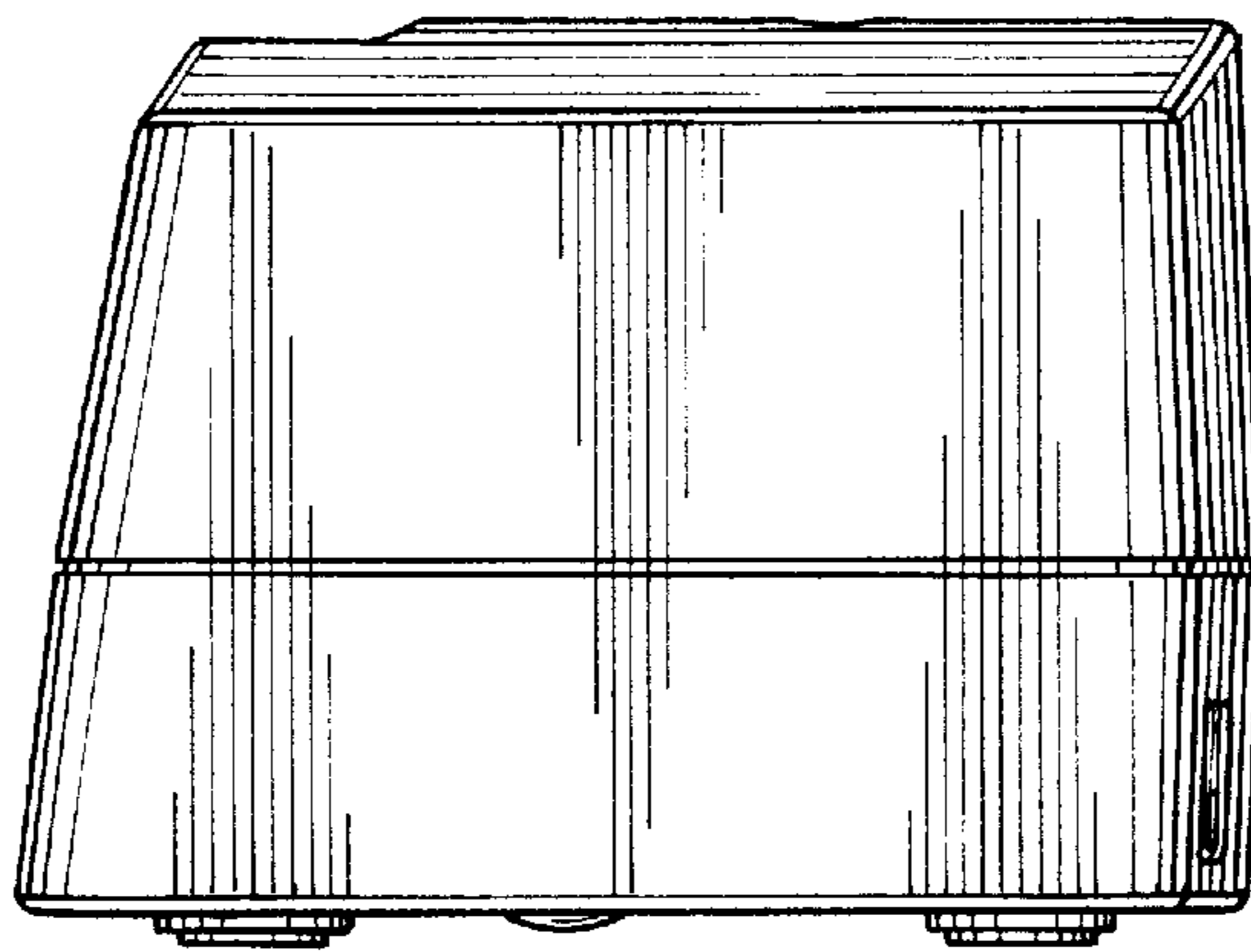
FIG. 1 is a front elevational view of an electric tape trimming device showing our new design; FIG. 2 is a right side view thereof; FIG. 3 is a top plan view thereof; FIG. 4 is a rear elevational view thereof; FIG. 5 is a left side view thereof; FIG. 6 is a bottom plan view thereof; FIG. 7 is a top, front and right side perspective view thereof; and, FIG. 8 is a bottom, front and right side perspective view thereof.

**1 Claim, 3 Drawing Sheets**

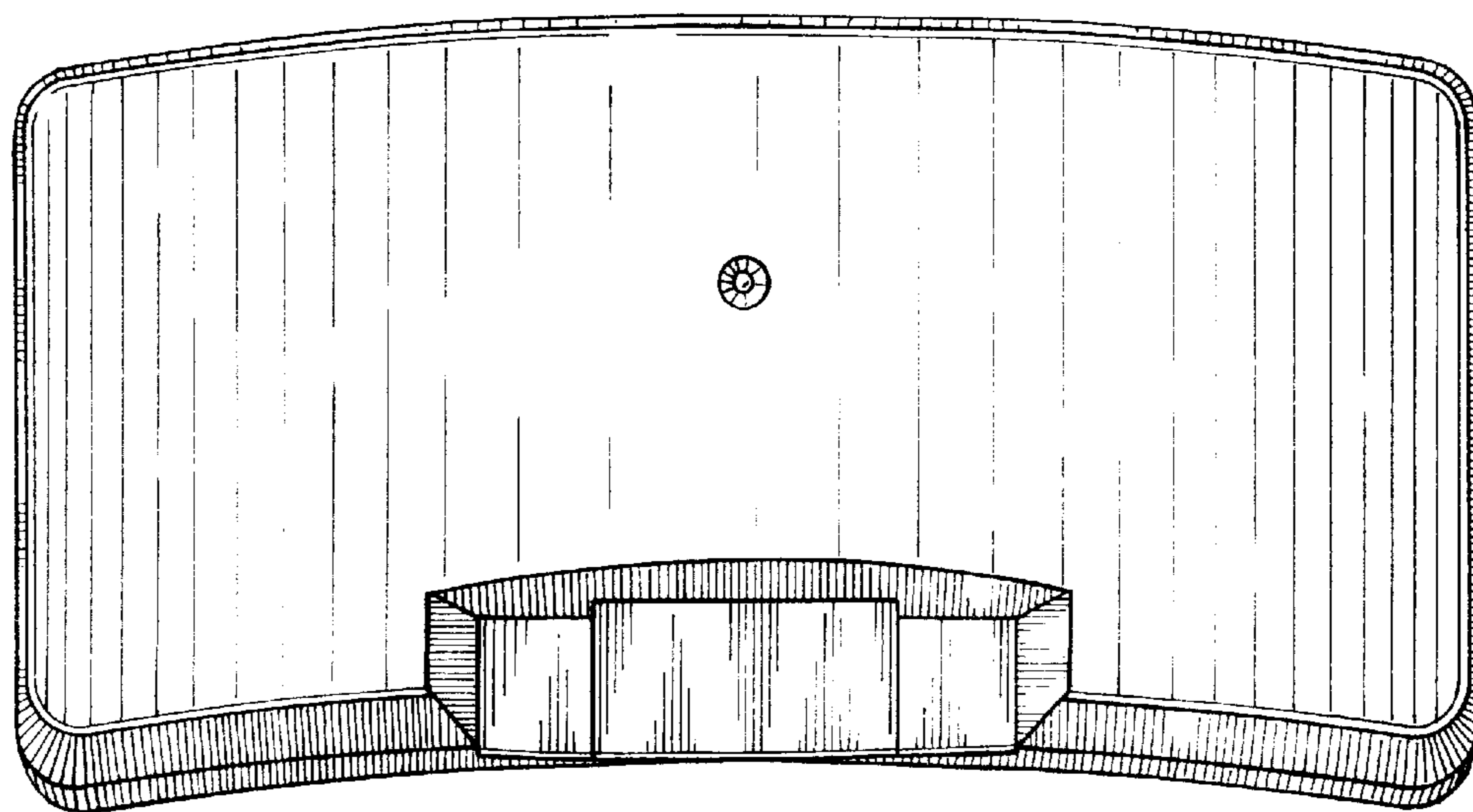




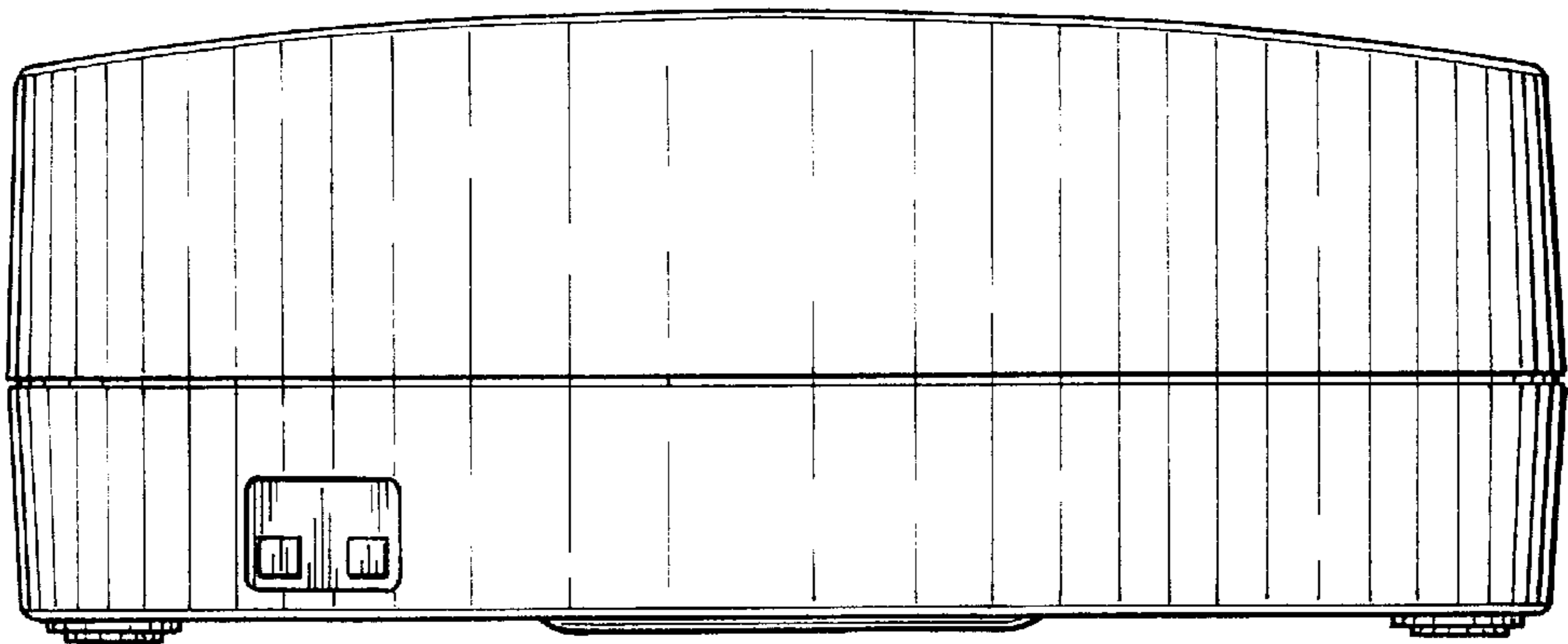
*Fig. 1*



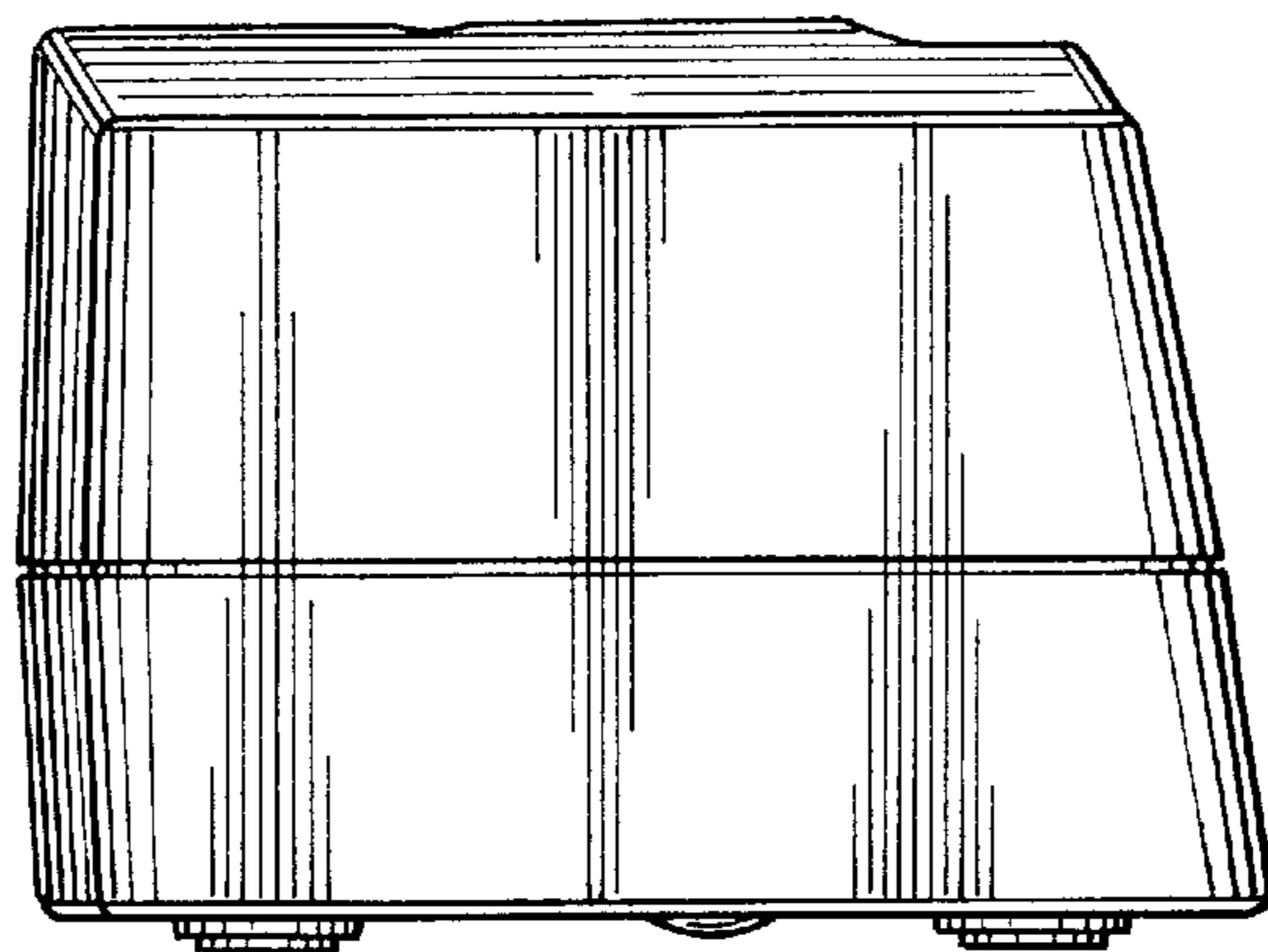
*Fig. 2*



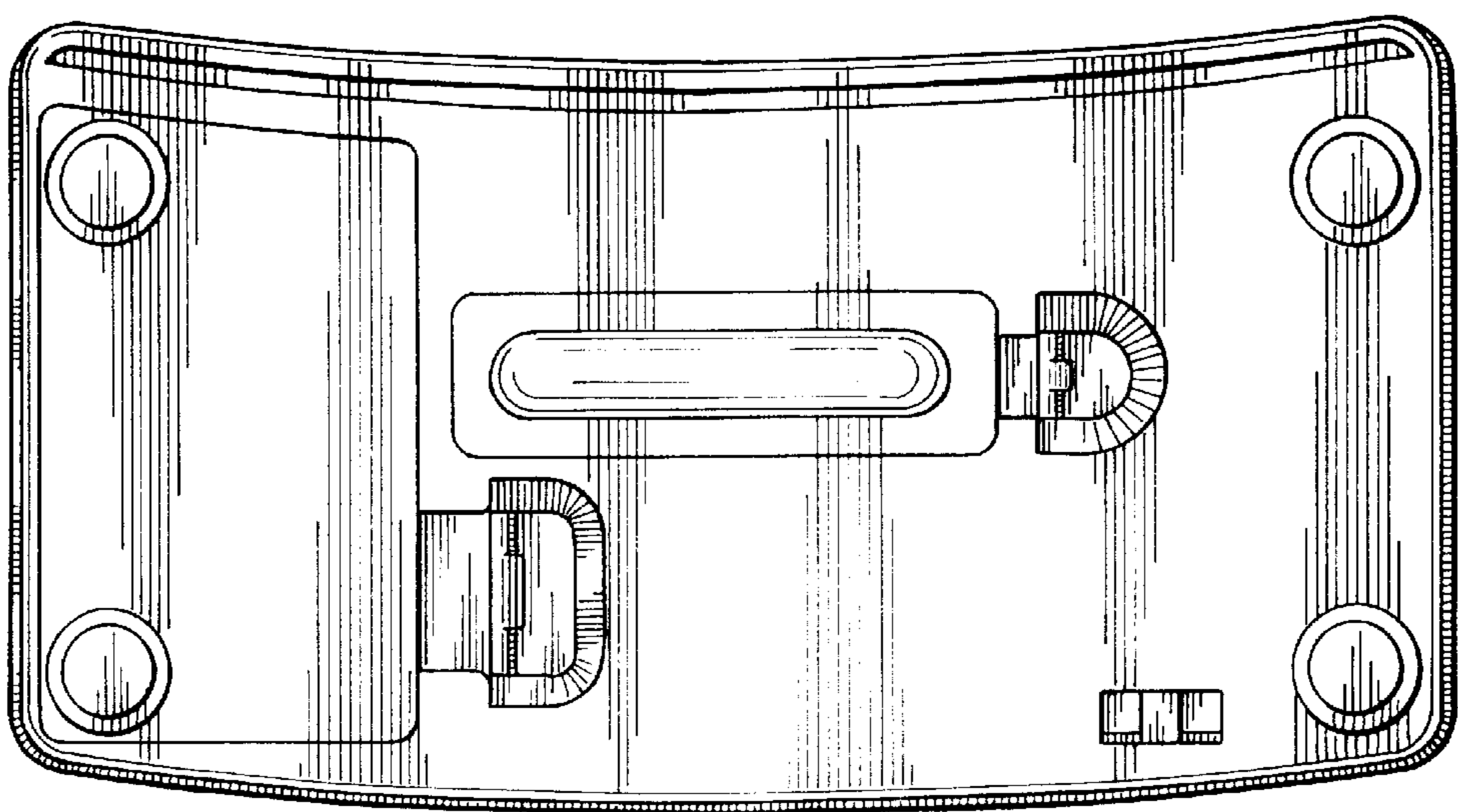
*Fig. 3*



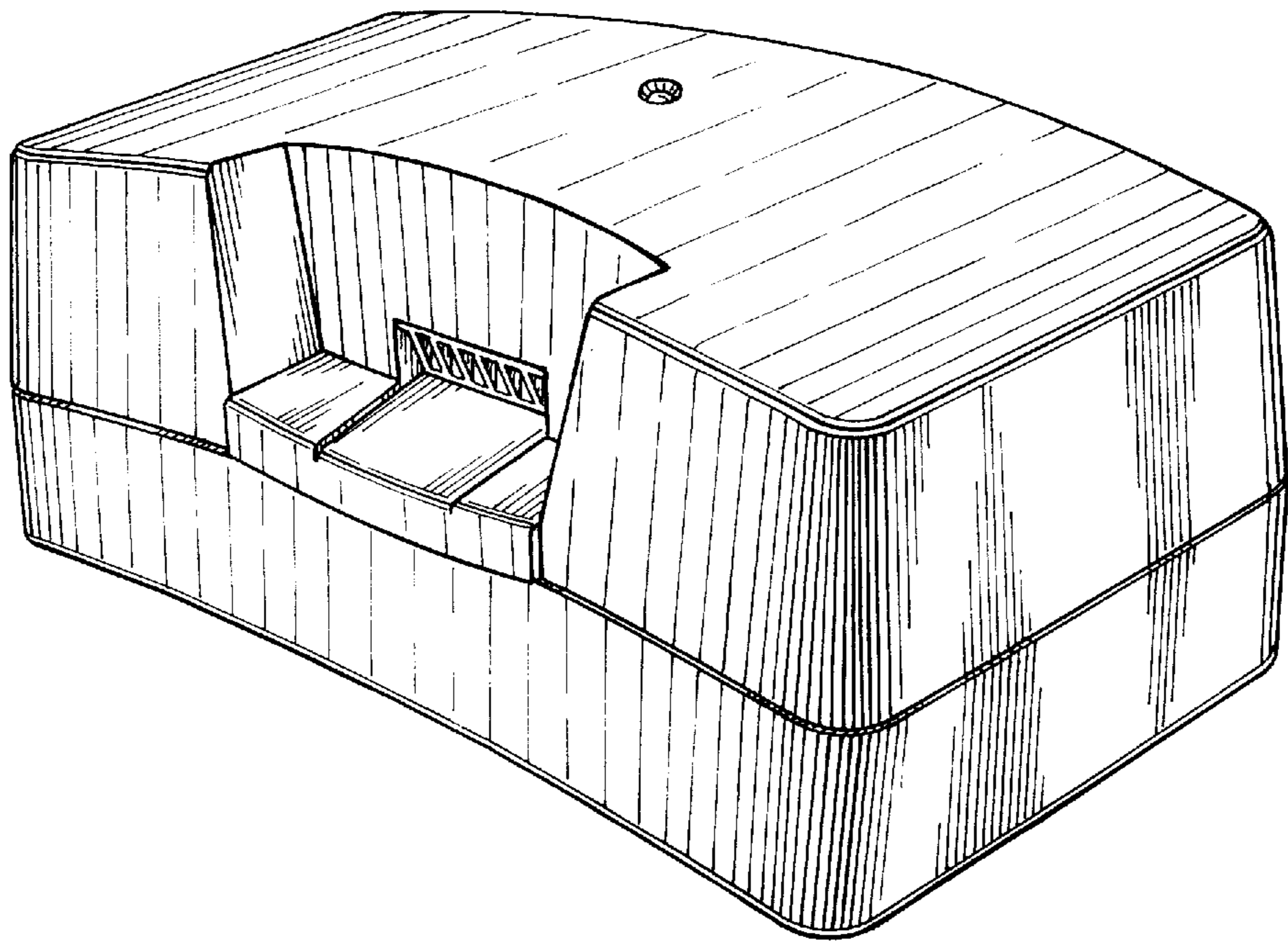
*Fig. 4*



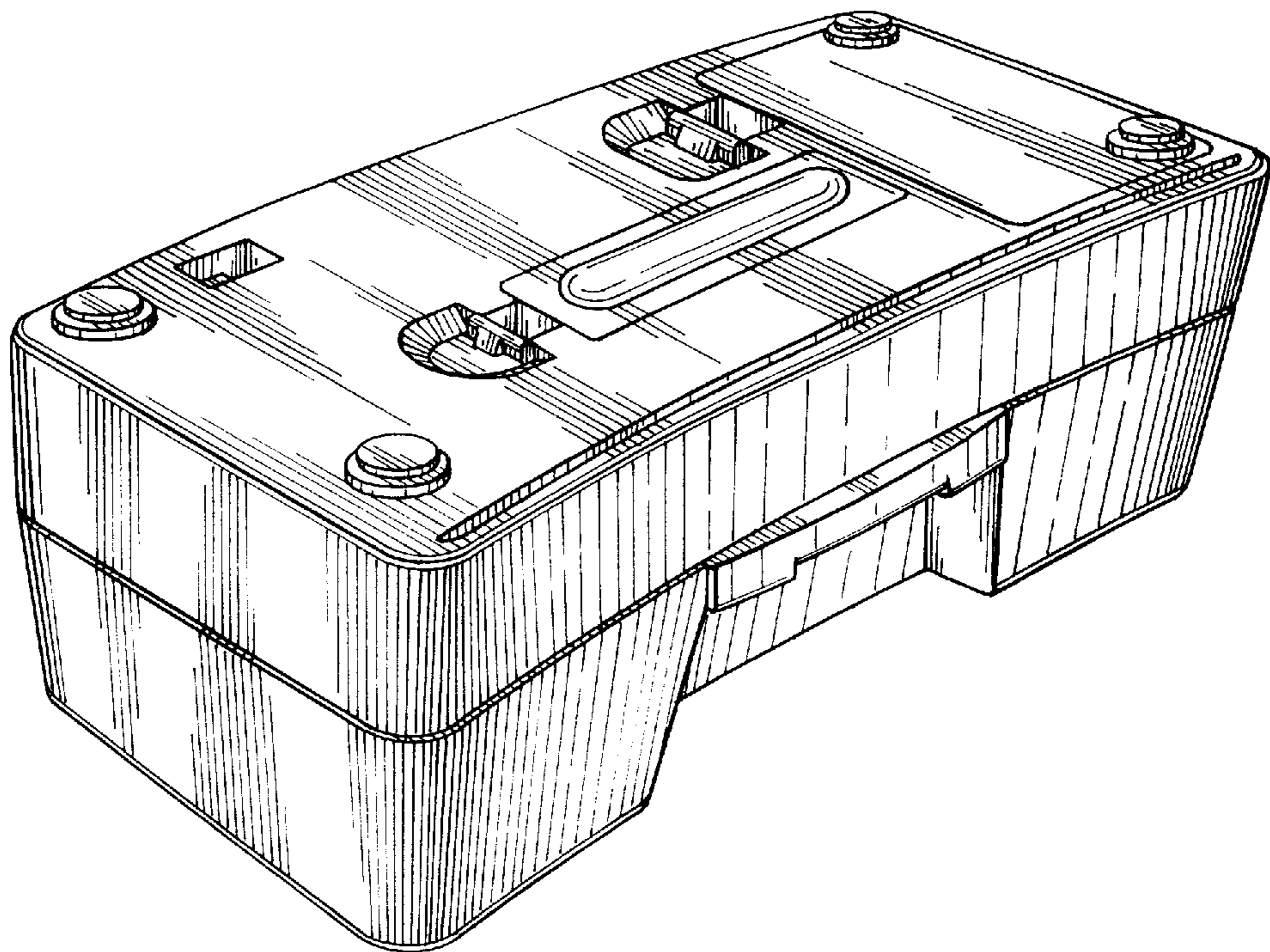
*Fig. 5*



*Fig. 6*



*Fig. 7*



*Fig. 8*