



US00D401022S

United States Patent [19] Mondigo

[11] **Patent Number: Des. 401,022**

[45] **Date of Patent: **Nov. 10, 1998**

[54] **POWER HEAD FOR CLEANING MACHINE**

[75] Inventor: **Jesse V. Mondigo**, Aurora, Ill.

[73] Assignee: **Minuteman International, Inc.**,
Addison, Ill.

[**] Term: **14 Years**

[21] Appl. No.: **61,176**

[22] Filed: **Oct. 17, 1996**

[51] **LOC (6) Cl. 15-05**

[52] **U.S. Cl. D32/31; D32/32; D32/34**

[58] **Field of Search D32/31-34; 15/320,
15/321, 322, 415.1, 416, 418-422.1**

[56] **References Cited**

U.S. PATENT DOCUMENTS

D. 232,298	8/1974	Jones	D32/32
D. 242,211	11/1976	Parise	D32/32
D. 246,523	11/1977	Bartlett	D32/32
D. 255,359	6/1980	Bartlett	D32/32
D. 264,139	4/1982	Pearman, Jr.	D32/32
D. 289,336	4/1987	Fitzwater	D32/32

D. 335,942	5/1993	Furcron	D32/32
D. 347,504	5/1994	Furcron et al.	D32/33
D. 353,918	12/1994	Bruno et al.	D32/32
3,962,745	6/1976	Collier	D32/32
4,825,501	5/1989	Ashby et al.	D32/32

Primary Examiner—Ruth McInroy
Attorney, Agent, or Firm—Emrich & Dithmar

[57] **CLAIM**

The ornamental design for a power head for cleaning machine, as shown and described.

DESCRIPTION

FIG. 1 is an upper, frontal perspective view of a power head for a cleaning machine showing my new design; FIG. 2 is a left side view thereof; FIG. 3 is a right side view thereof; FIG. 4 is a top plan view thereof; FIG. 5 is a front elevation view thereof; FIG. 6 is a rear elevation view thereof; and, FIG. 7 is a bottom plan view thereof, the brush shown in broken lines is for illustrative purposes only and forms no part of the claimed design.

1 Claim, 7 Drawing Sheets

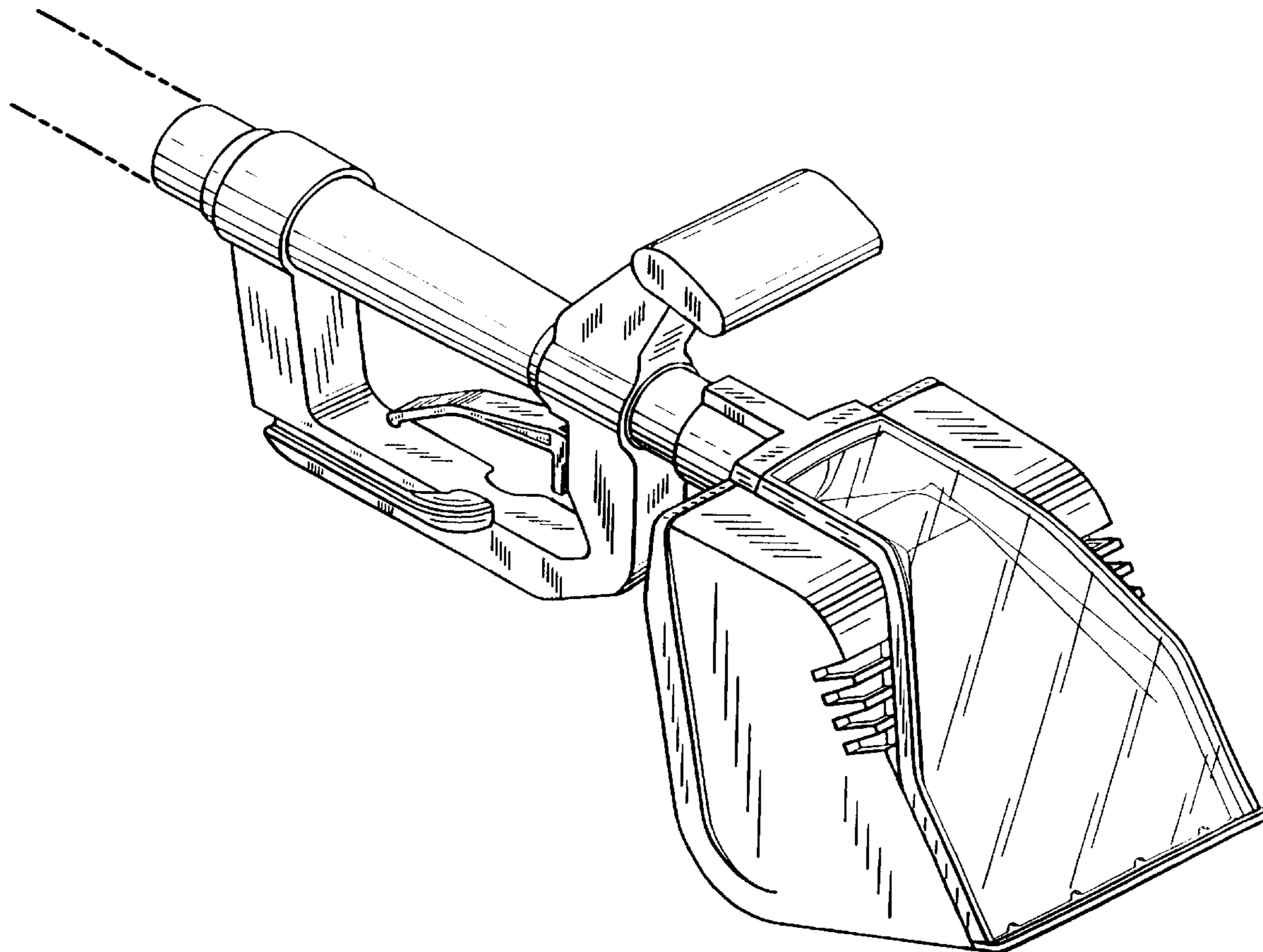

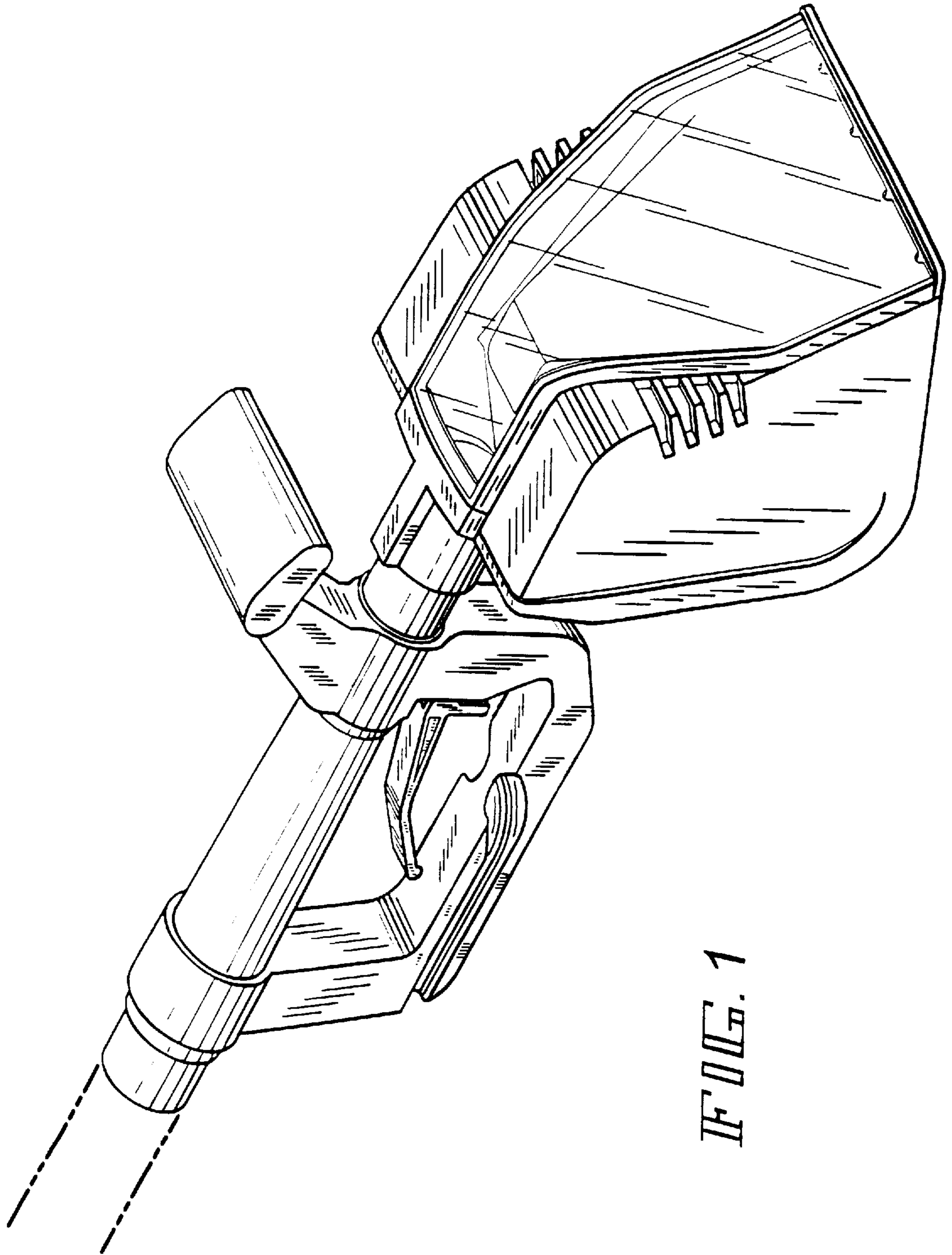

FIG. 1

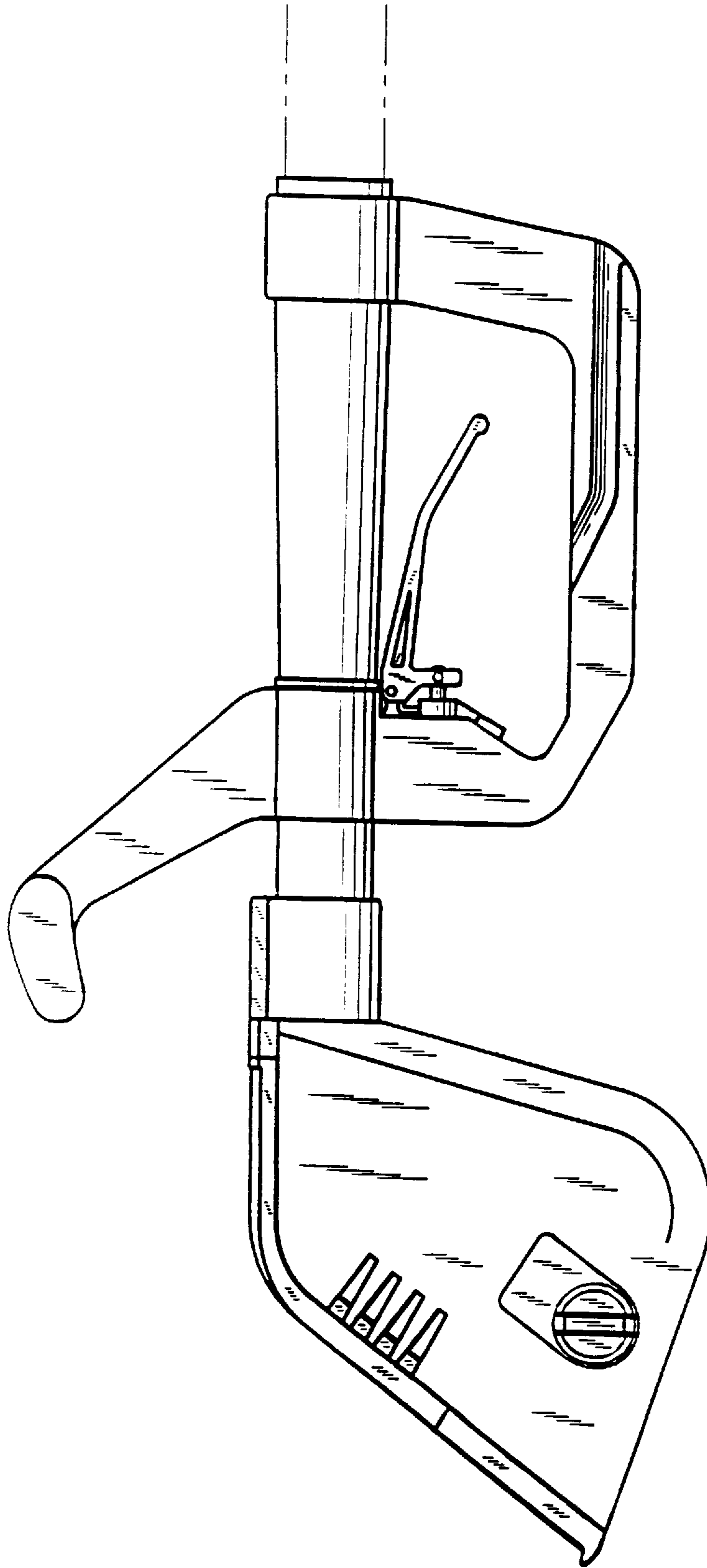

FIG. 2

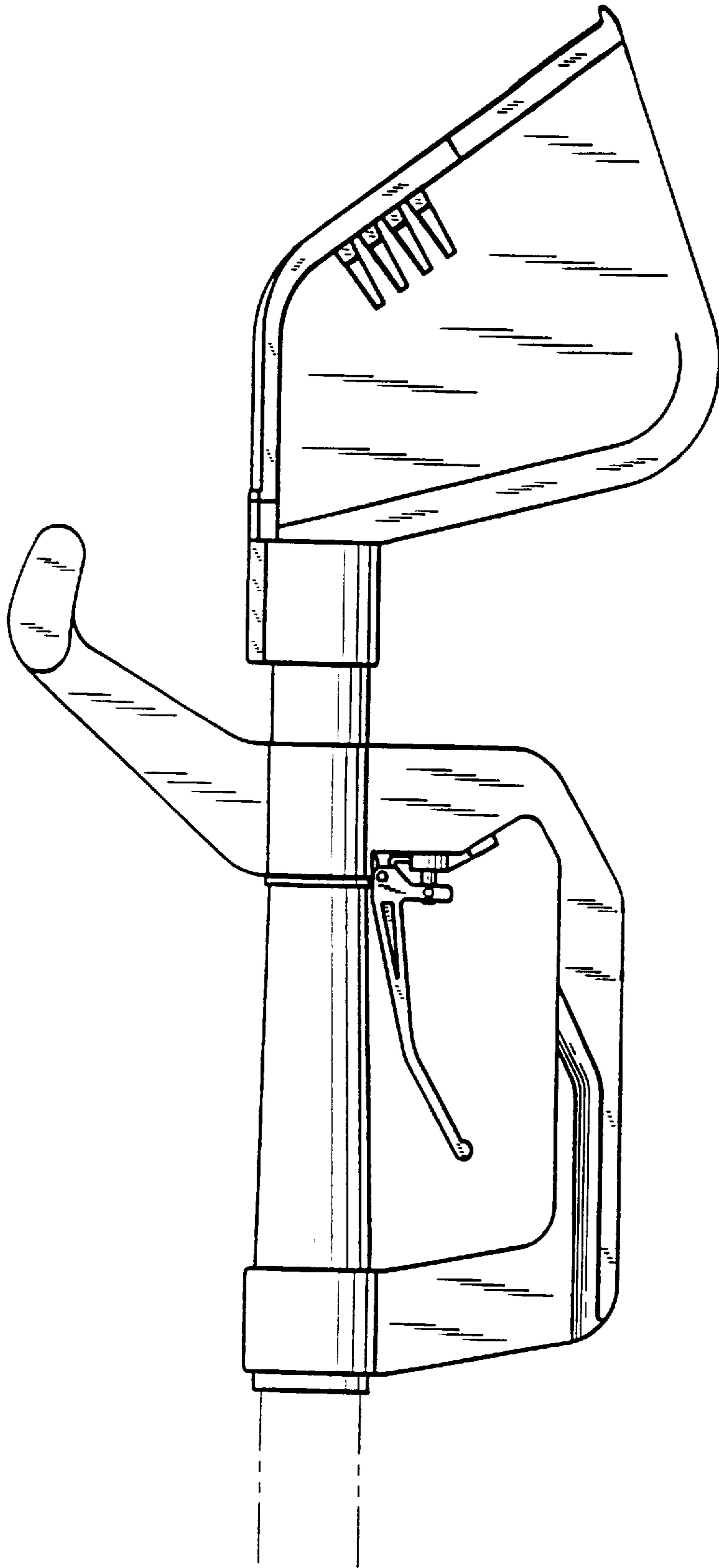

FIG. 3

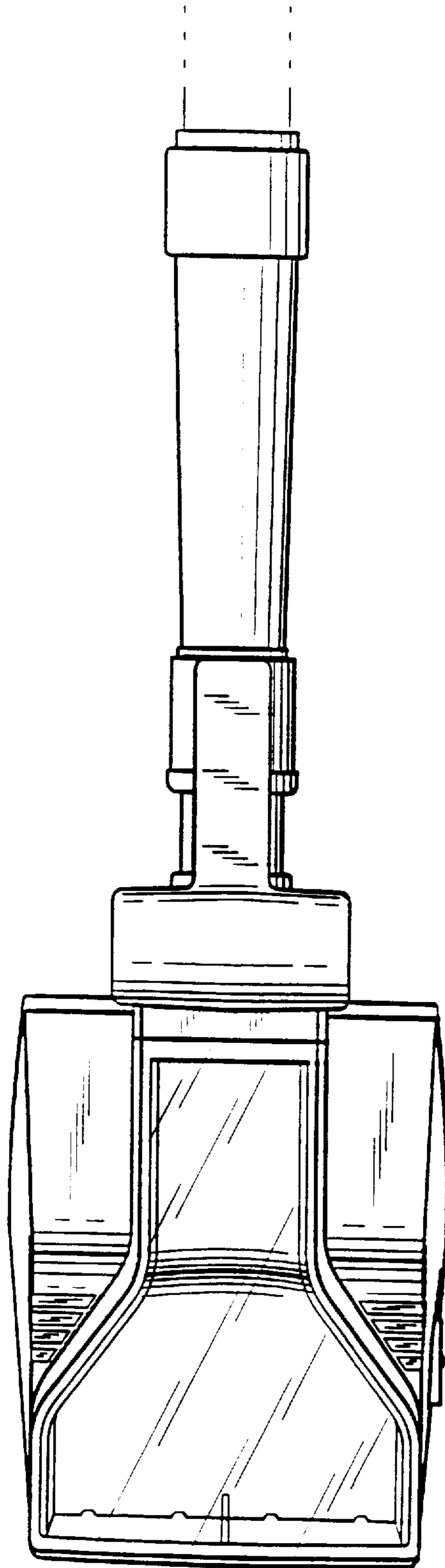

FIG. 4

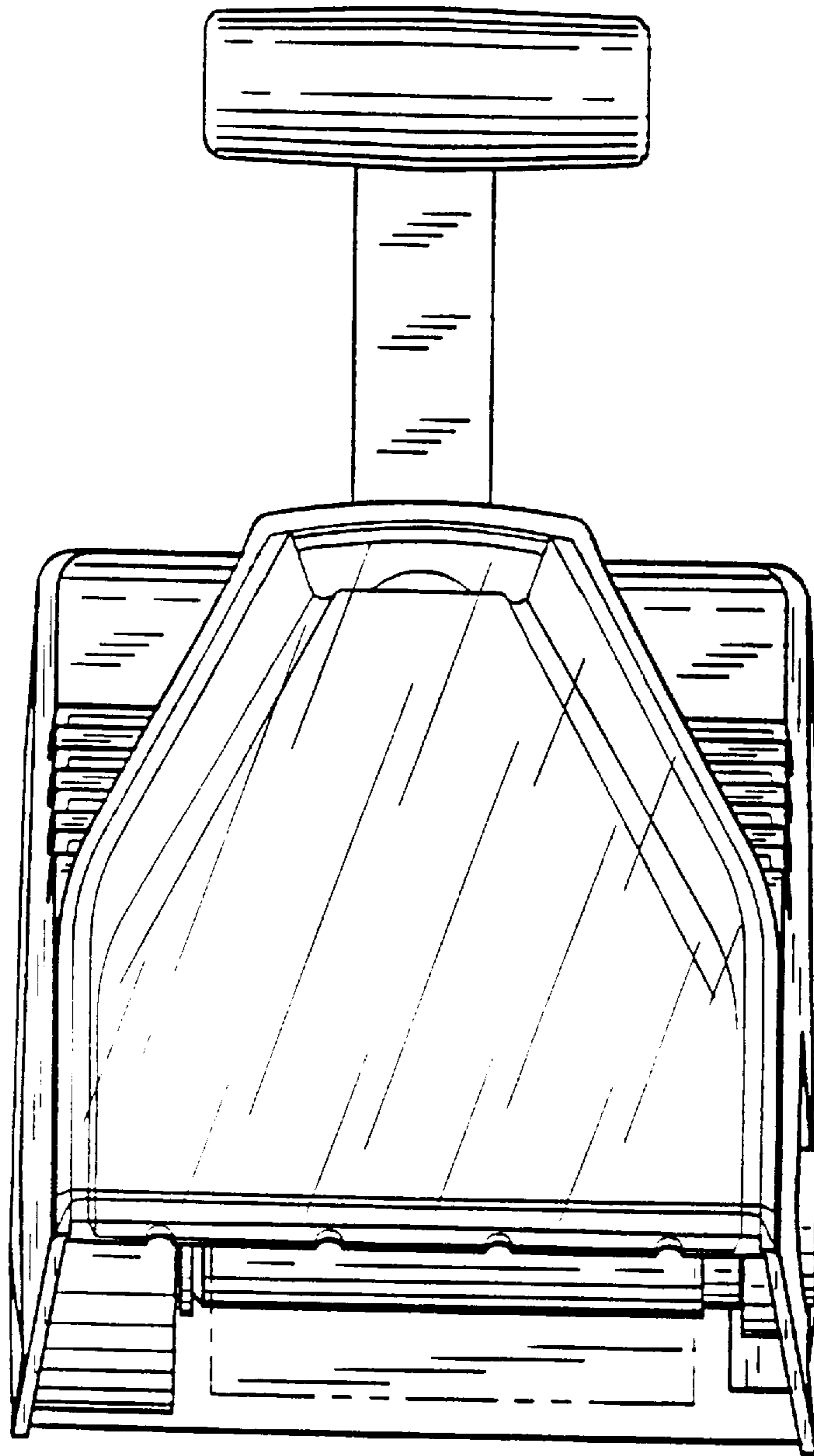

FIG. 5

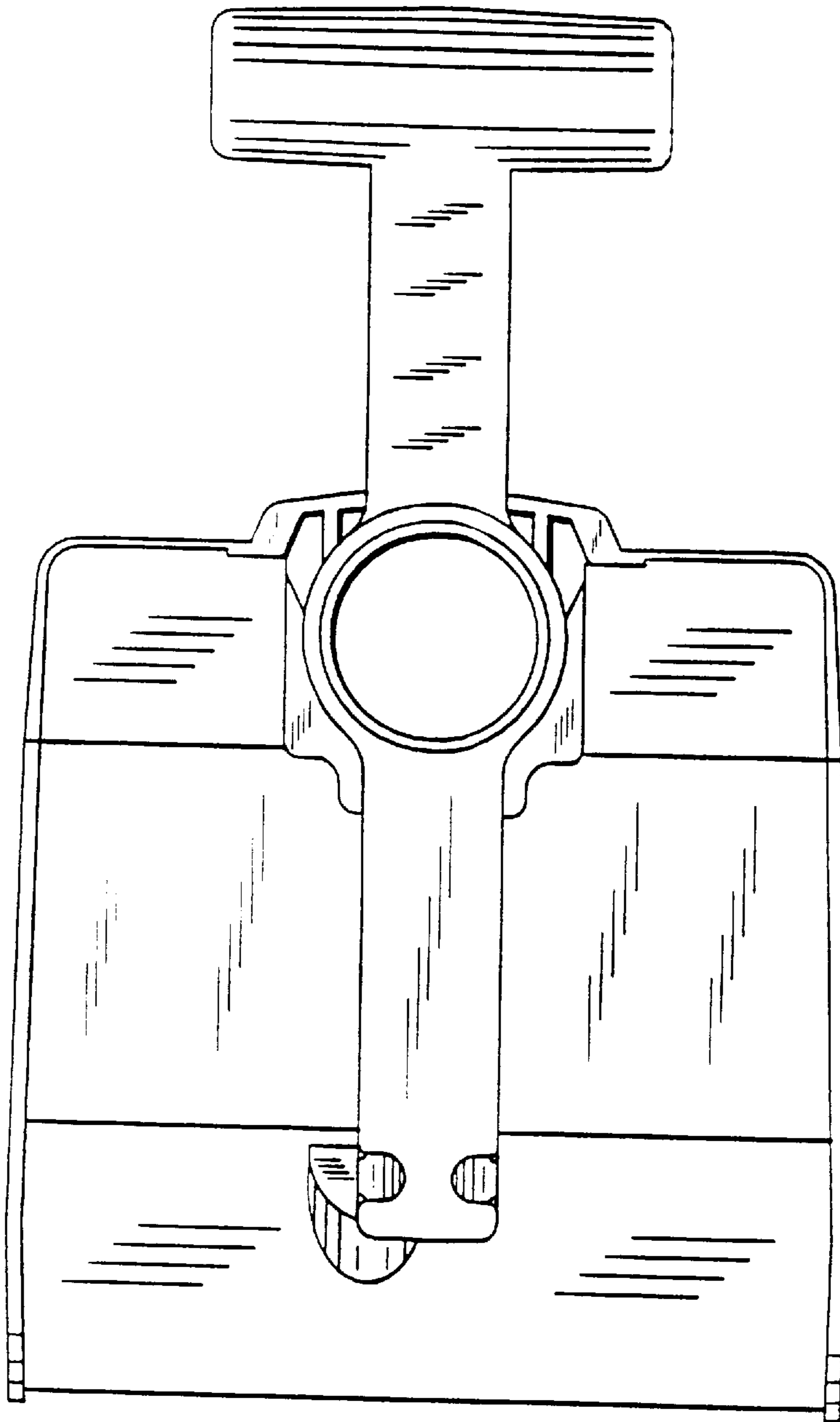

FIG. 6

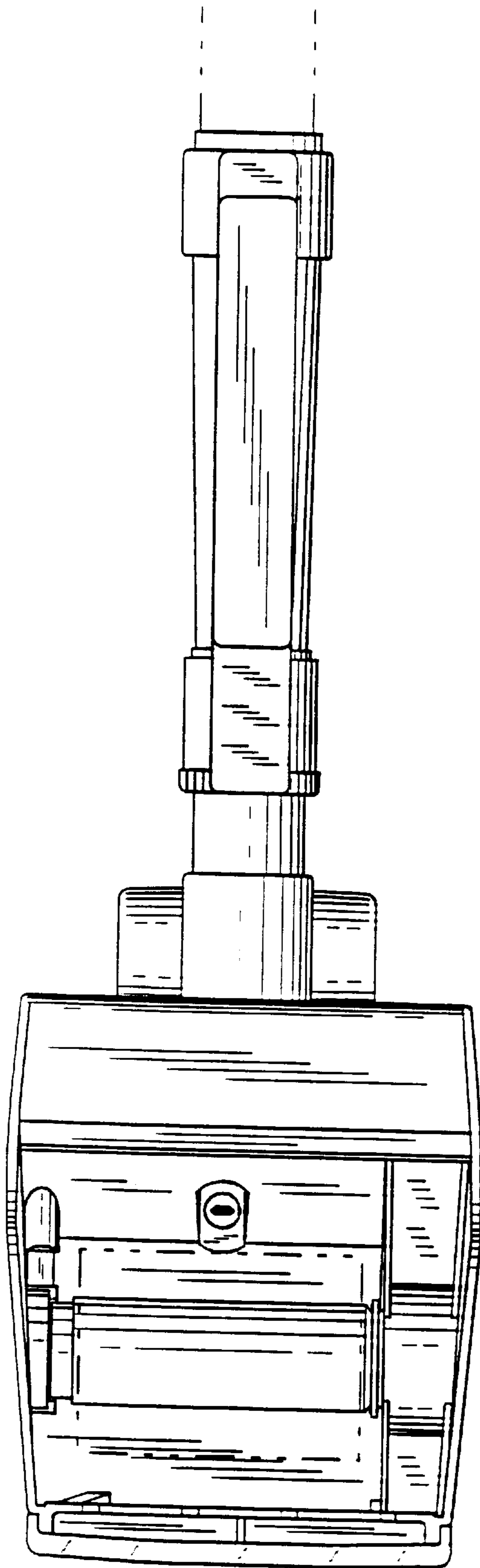

FIG. 7