



US00D401015S

United States Patent [19]

Sussman

[11] **Patent Number: Des. 401,015**

[45] **Date of Patent: **Nov. 10, 1998**

[54] **FINGERNAIL POLISHING ORGANIZER**

[76] Inventor: **Robert Sussman**, 10120 Vestal Ct.,
Coral Springs, Fla. 33071

[**] Term: **14 Years**

[21] Appl. No.: **78,589**

[22] Filed: **Oct. 28, 1997**

[51] **LOC (6) Cl. 28-03**

[52] **U.S. Cl. D28/61; D6/467; D19/75;**
D19/76; D19/77

[58] **Field of Search D28/61, 73; D3/205,**
D3/313, 901; D6/449, 466-469, 471, 473-476;
D19/75, 77, 92, 95; 132/73, 73.5, 75, 286,
314; 206/581, 823, 371-373, 557, 558,
565, 214; 220/500, 553-555; 211/10, 11,
50, 55, 71, 72, 24, 126.1, 126.16

[56] **References Cited**

U.S. PATENT DOCUMENTS

D. 117,278	10/1939	Kayton	D6/473
D. 210,989	5/1968	Huncovsky	D3/313
D. 241,683	9/1976	Mark	D3/313 X
D. 252,409	7/1979	Rose et al.	D3/901 X
D. 273,810	5/1984	Zinbarg	D28/61
D. 301,590	6/1989	Foran et al.	D19/77

D. 354,310	1/1995	Crist et al.	D19/75
D. 367,948	3/1996	Hsu	D28/73
D. 373,445	9/1996	Wright-Godley	D28/61
D. 385,920	11/1997	Tisbo	D19/75
D. 387,498	12/1997	Sussman	D28/73

OTHER PUBLICATIONS

“Hong Kong Enterprise” Mar. 1986, p. 237—Cosmetic Organizer, Item No. D-18.

Primary Examiner—Ted Shooman

Assistant Examiner—C. Tuttle

Attorney, Agent, or Firm—Myron Amer PC

[57] **CLAIM**

The ornamental design for a fingernail polishing organizer, as shown and described.

DESCRIPTION

FIG. 1 is a perspective view, in reduced scale, of a fingernail polishing organizer showing my new design;
FIG. 2 is a plan view thereof;
FIG. 3 is a front elevational view thereof;
FIG. 4 is a right side elevational view thereof;
FIG. 5 is a bottom view thereof;
FIG. 6 is a rear view thereof; and,
FIG. 7 is a left side elevation view thereof.

1 Claim, 2 Drawing Sheets

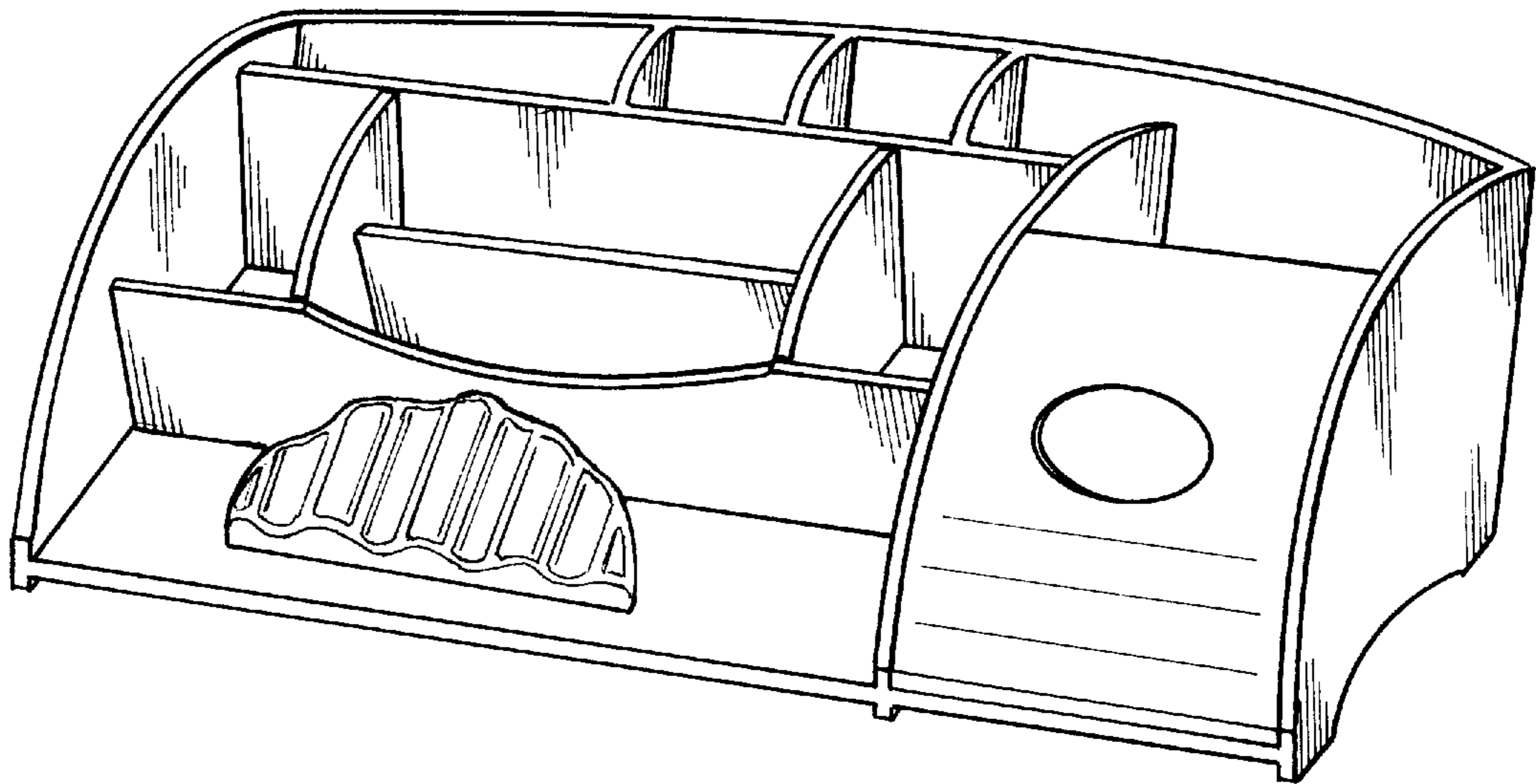

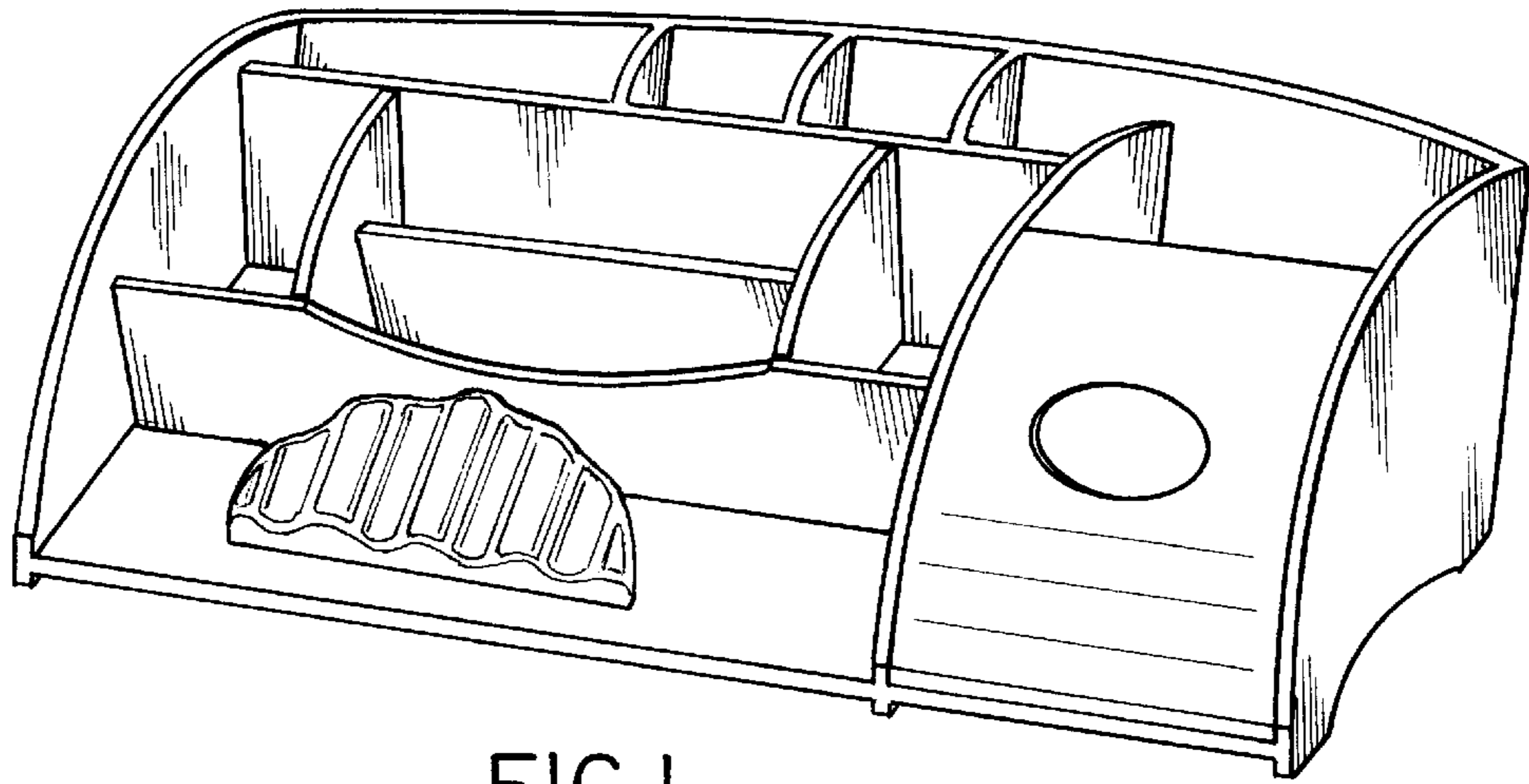

FIG. 1

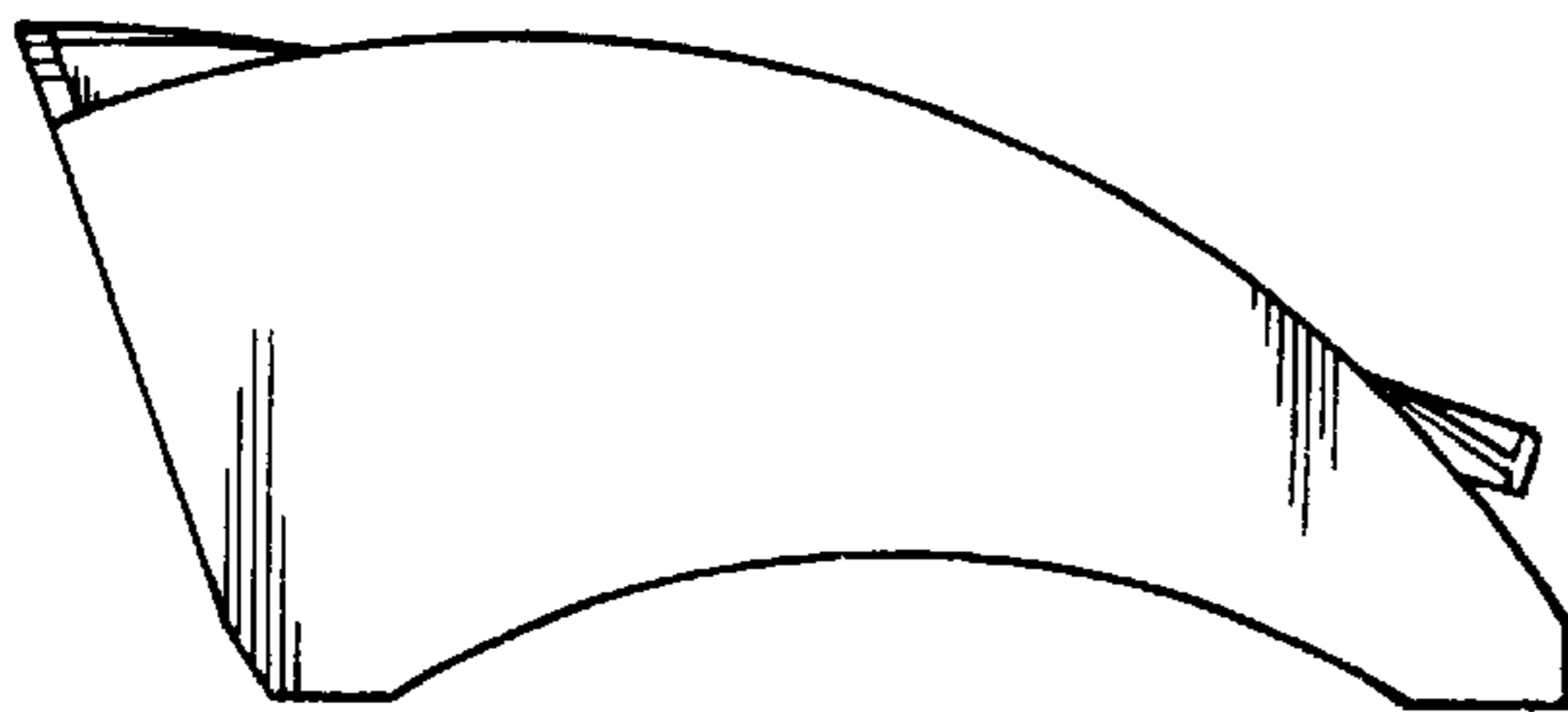

FIG. 7

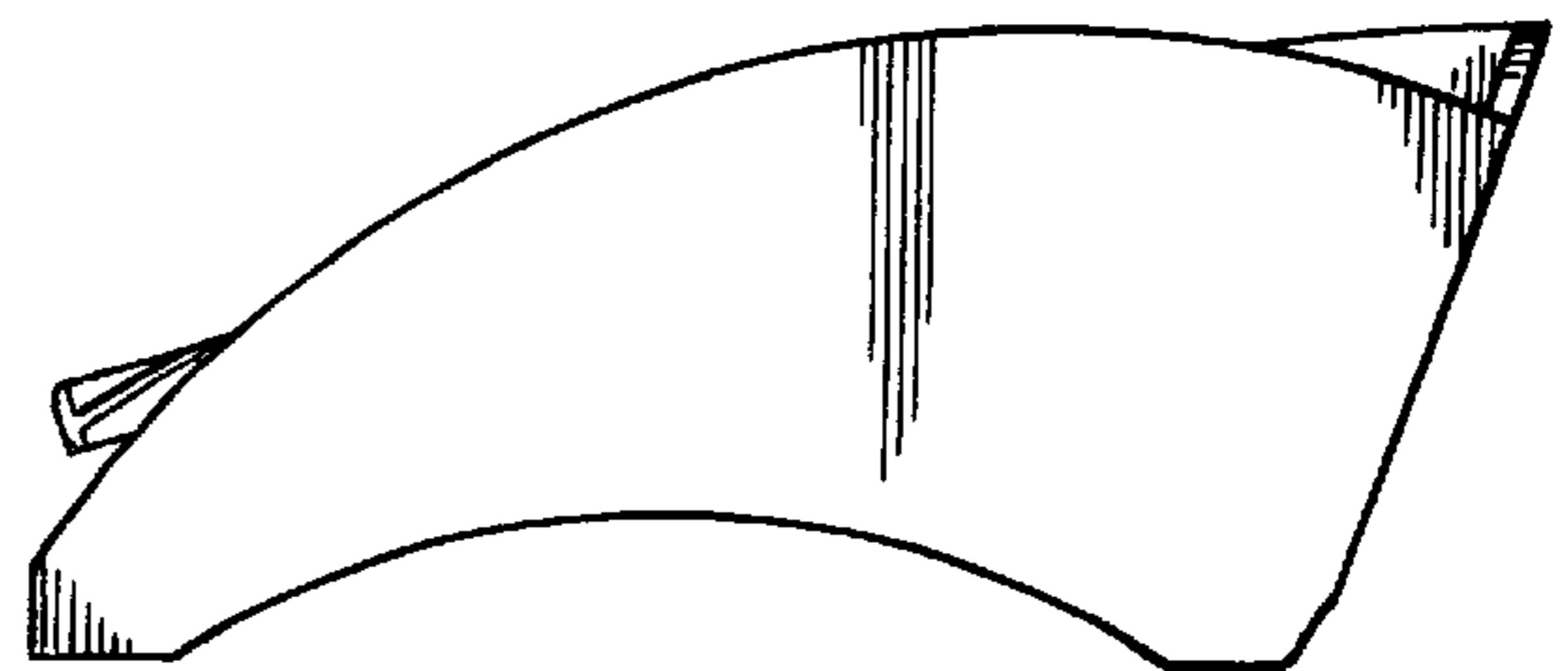

FIG. 4

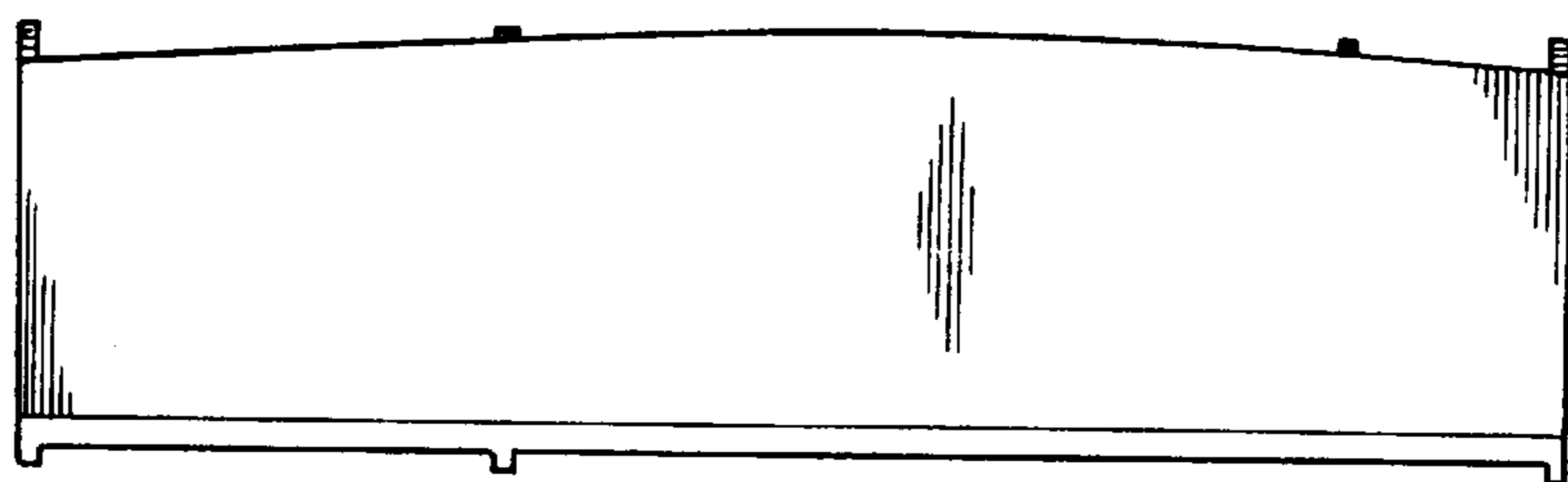

FIG. 6

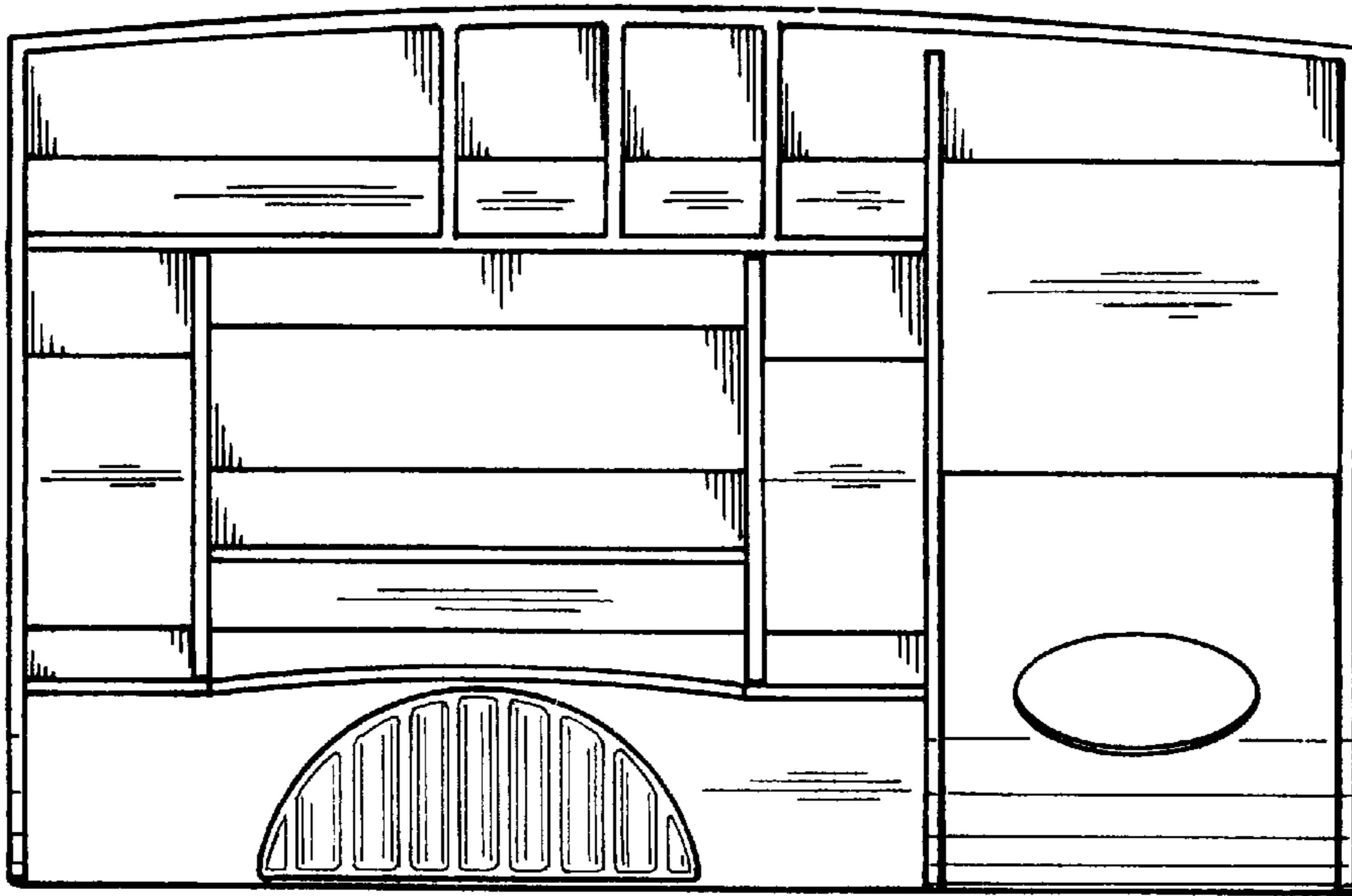

FIG. 2

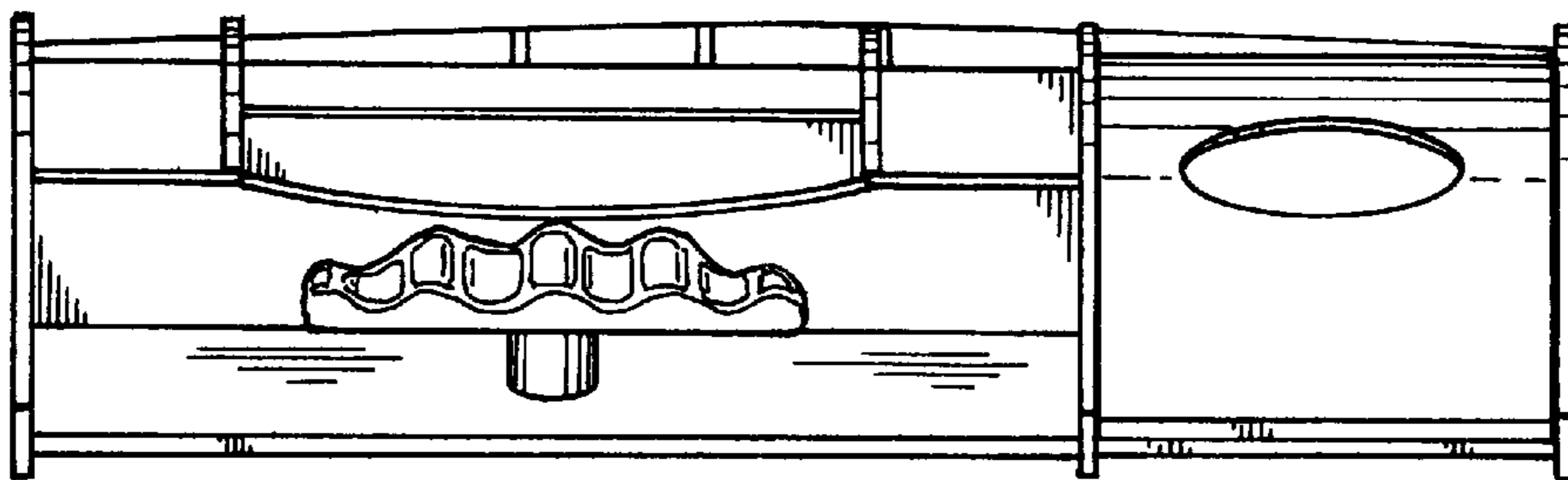

FIG. 3

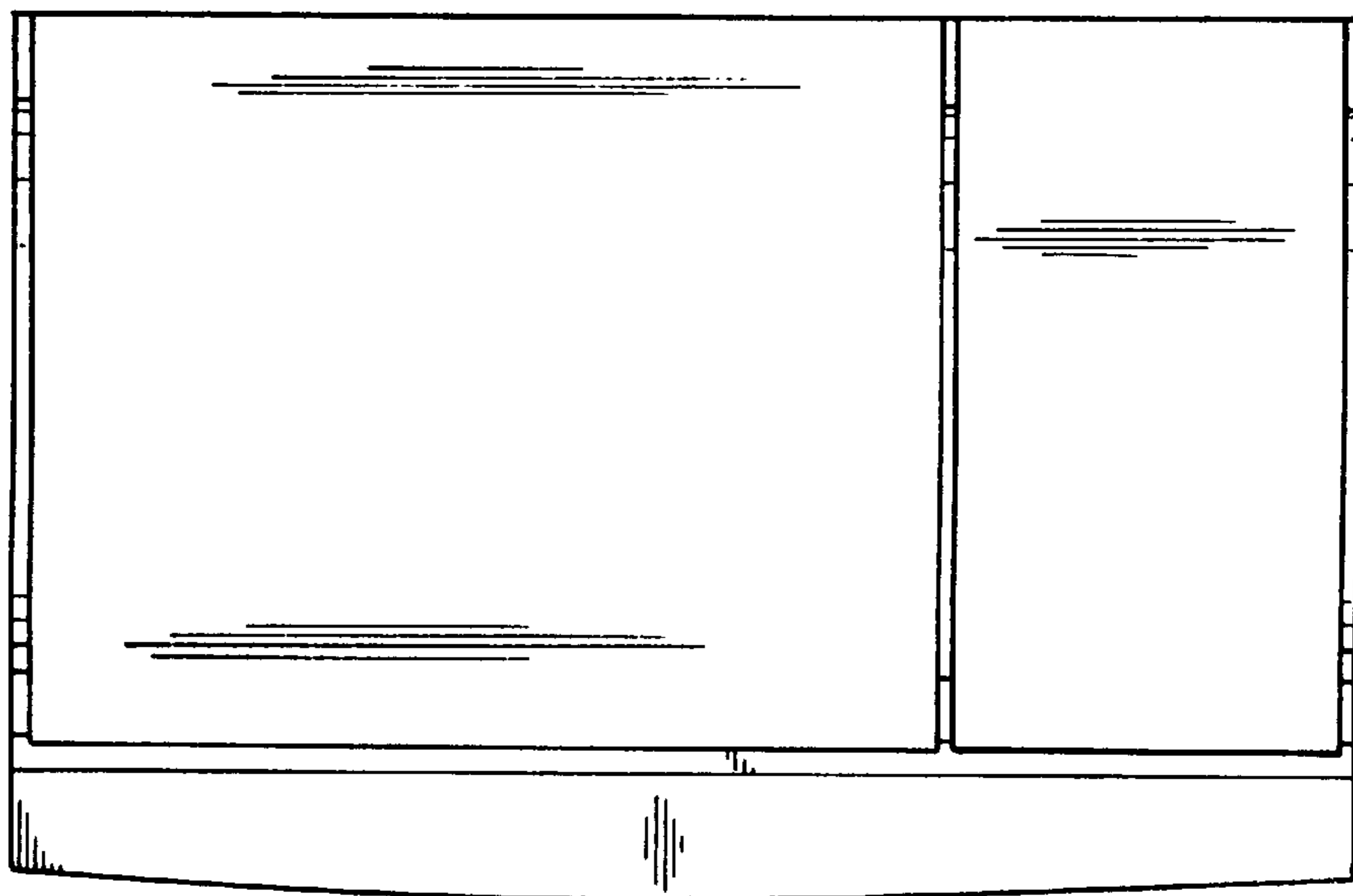

FIG. 5