



US00D401005S

United States Patent [19]

Ludbrook et al.

[11] **Patent Number: Des. 401,005**

[45] **Date of Patent: **Nov. 10, 1998**

[54] **HAT ATTACHABLE FLASHLIGHT HOLDER**

[75] Inventors: **Greg Ludbrook, Fenton; Joe Wimsatt, St. Louis, both of Mo.**

[73] Assignee: **Koller-Craft Plastic Products, Inc., Fenton, Mo.**

[**] Term: **14 Years**

[21] Appl. No.: **69,204**

[22] Filed: **Apr. 11, 1997**

[51] **LOC (6) Cl. 26-99**

[52] **U.S. Cl. D26/138; D2/395**

[58] **Field of Search D8/394-396; D26/138; 24/115 R, 115 H; 248/62**

[56] **References Cited**

U.S. PATENT DOCUMENTS

- D. 281,393 11/1985 Karnhag D8/373
- D. 293,206 12/1987 Beaty D8/395

- 1,858,284 5/1932 Schwartz 24/115 R X
- 2,973,537 3/1961 Simpson 24/115 X
- 4,973,014 11/1990 Daigle 248/62

Primary Examiner—Holly Baynham
Attorney, Agent, or Firm—Kevin L. Klug

[57] **CLAIM**

The ornamental design for a hat attachable flashlight holder, as shown and described.

DESCRIPTION

FIG. 1 is a perspective view of a hat attachable flashlight holder showing our novel design; FIG. 2 is a right side view thereof; FIG. 3 is a rear side view thereof which is symmetric with the front side plan view; FIG. 4 is a left side view thereof; FIG. 5 is a top side plan view thereof; and, FIG. 6 is a bottom plan view thereof which is symmetric.

1 Claim, 4 Drawing Sheets

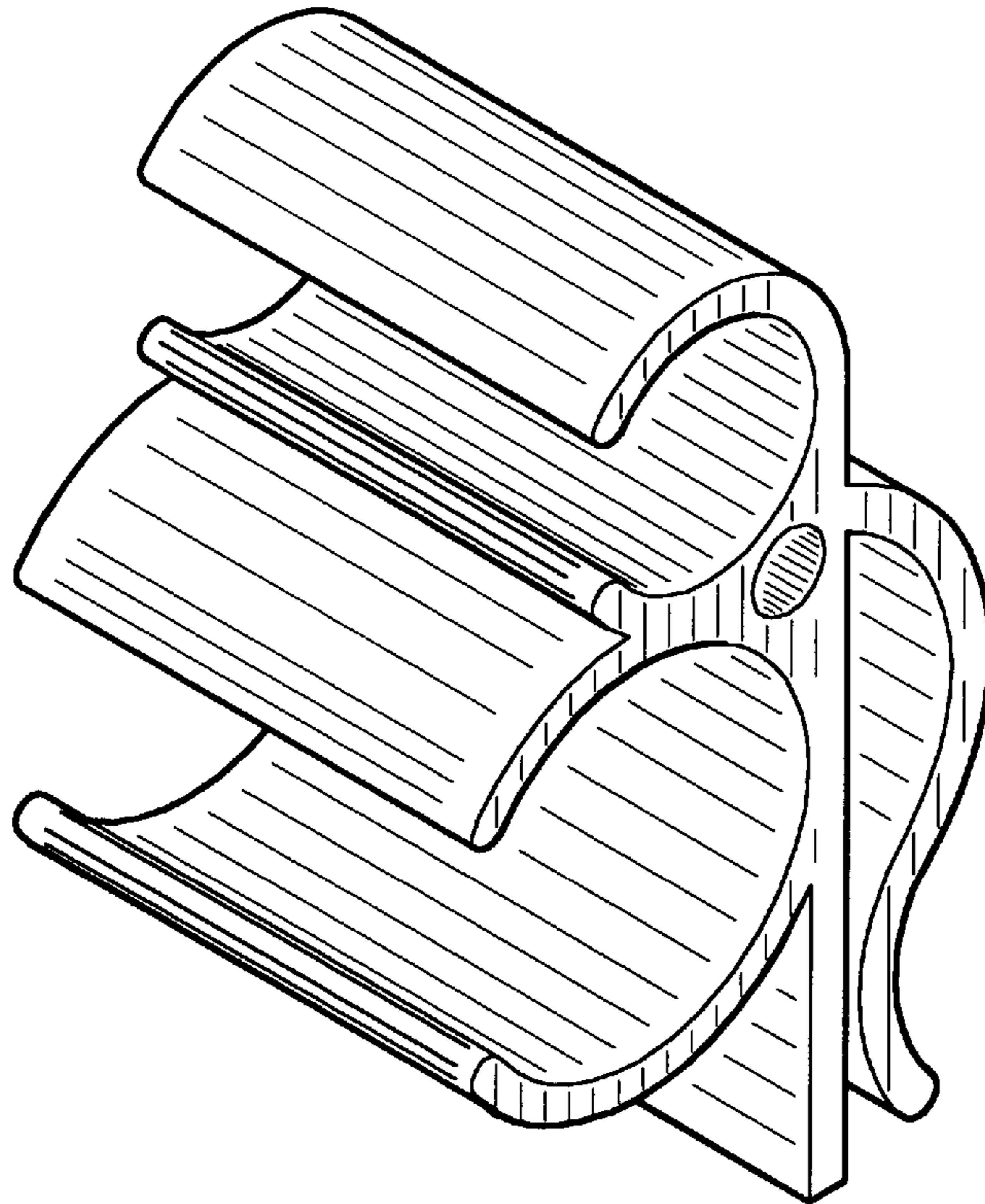

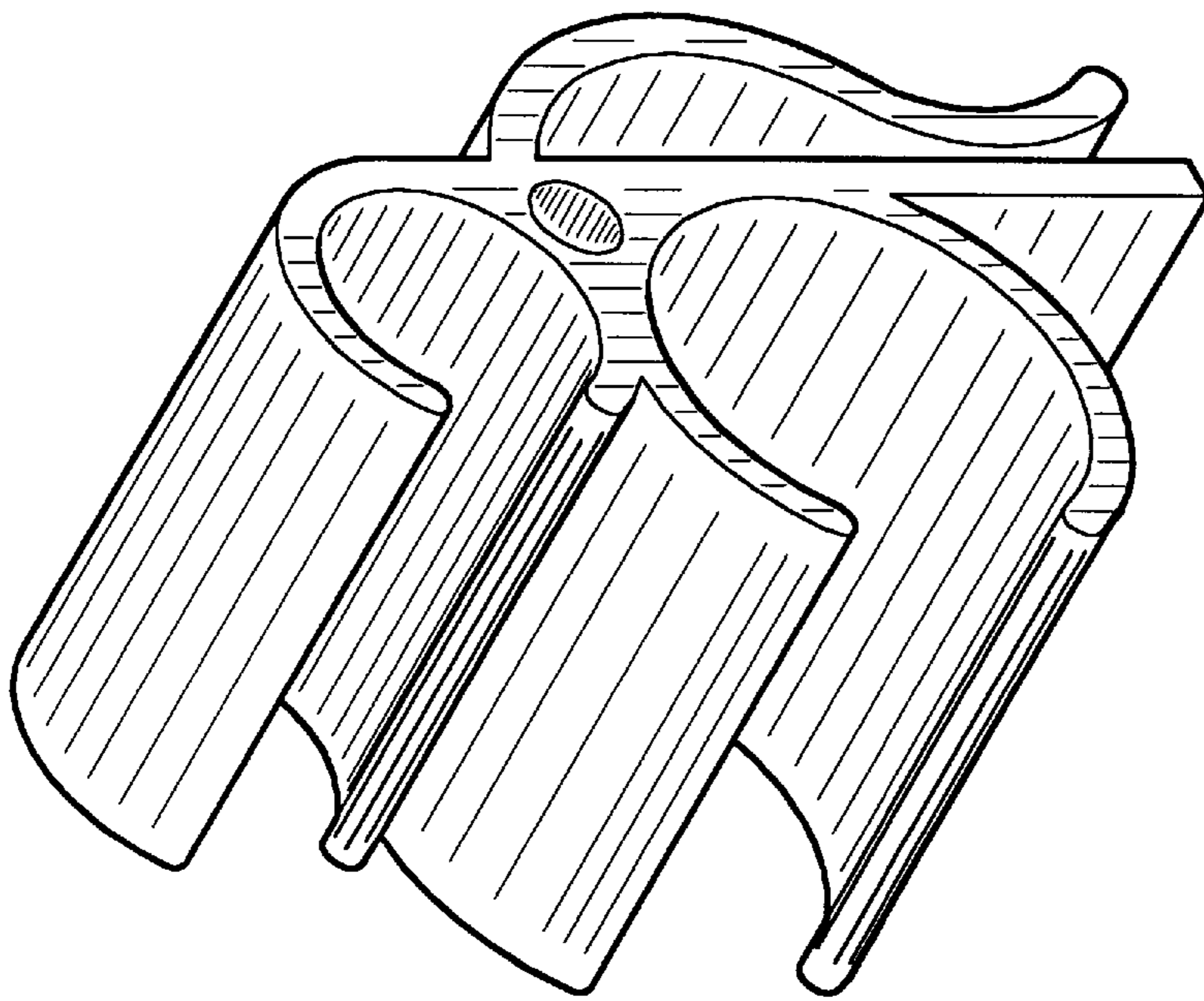

Figure 1

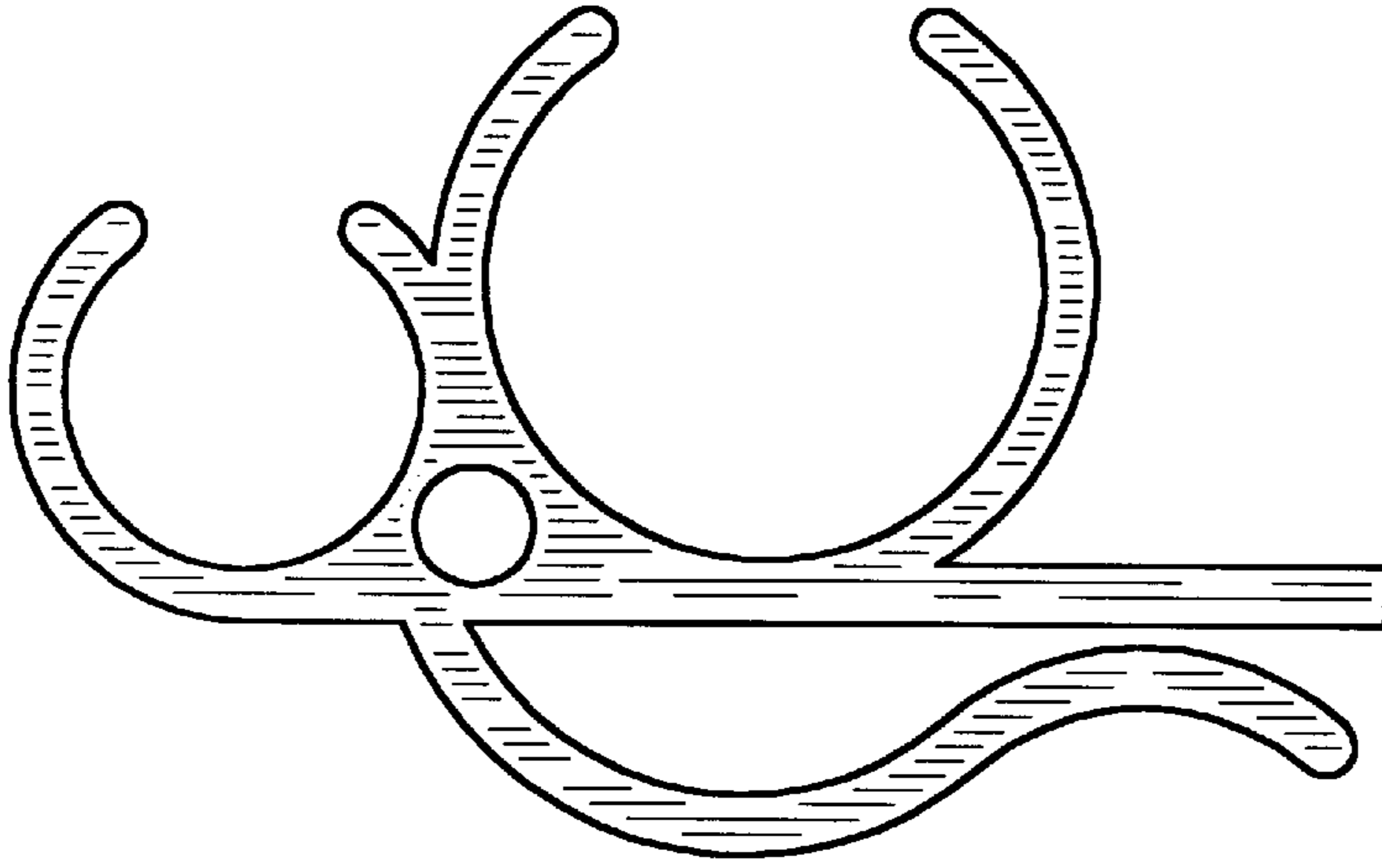

Figure 3

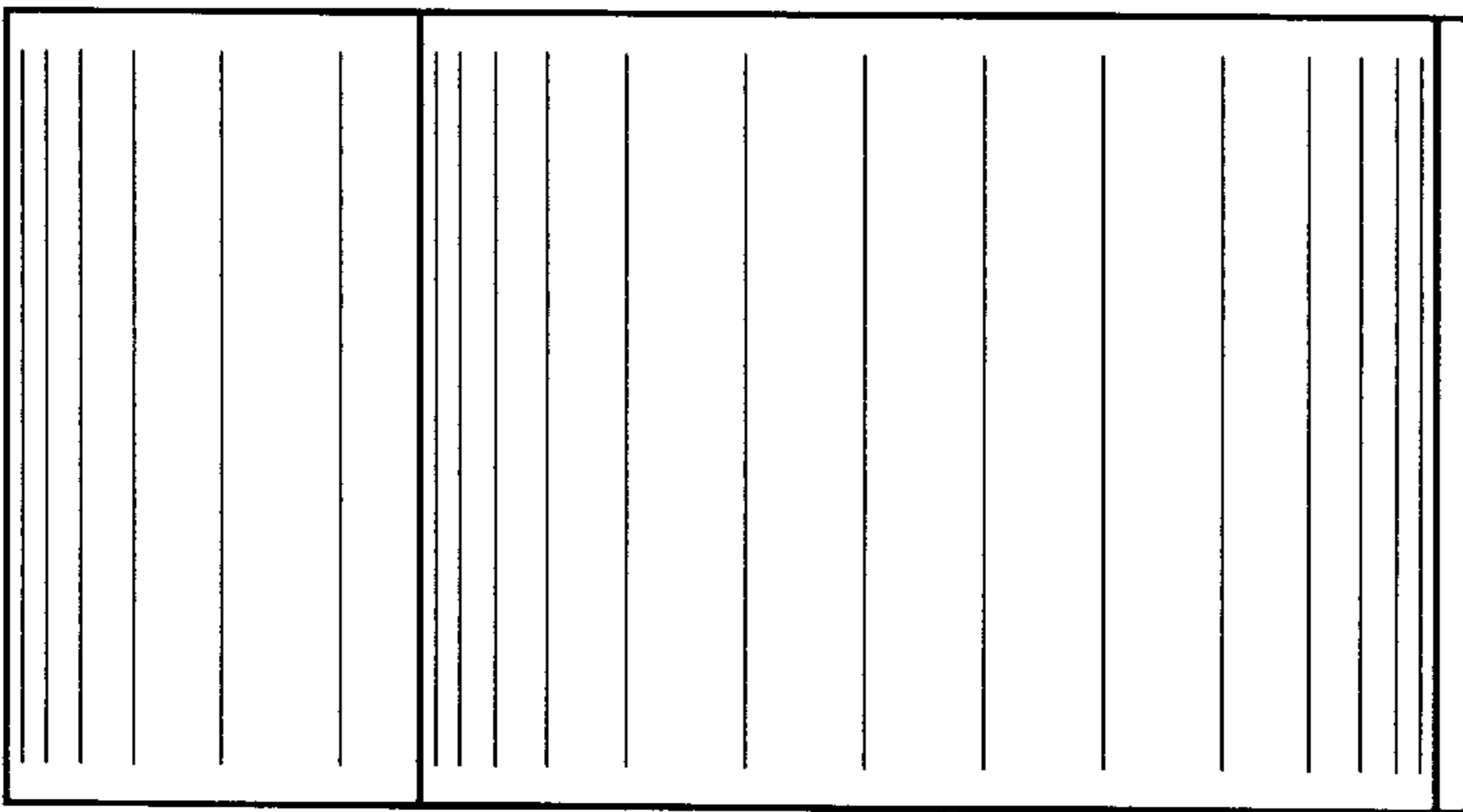

Figure 2

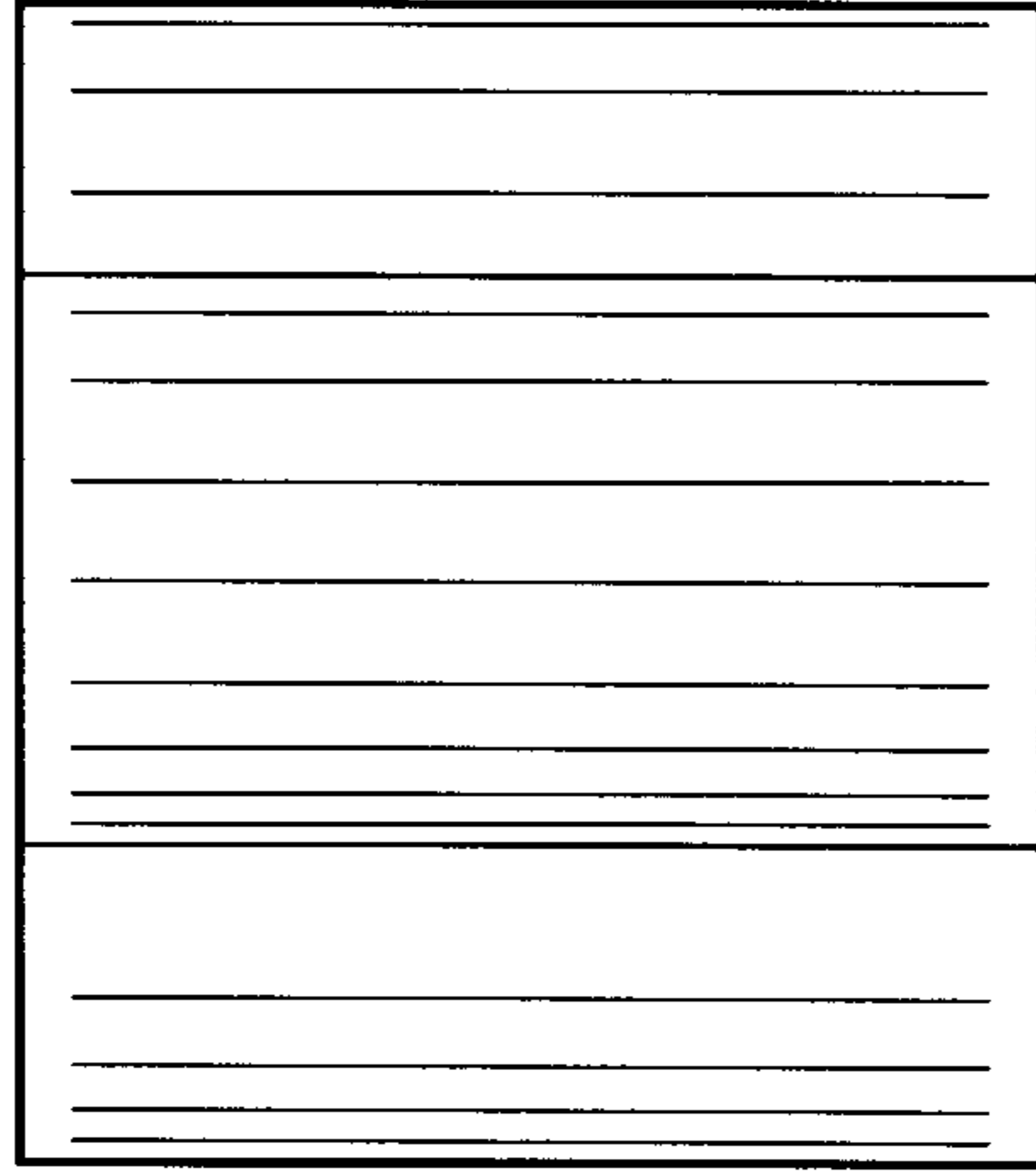

Figure 5

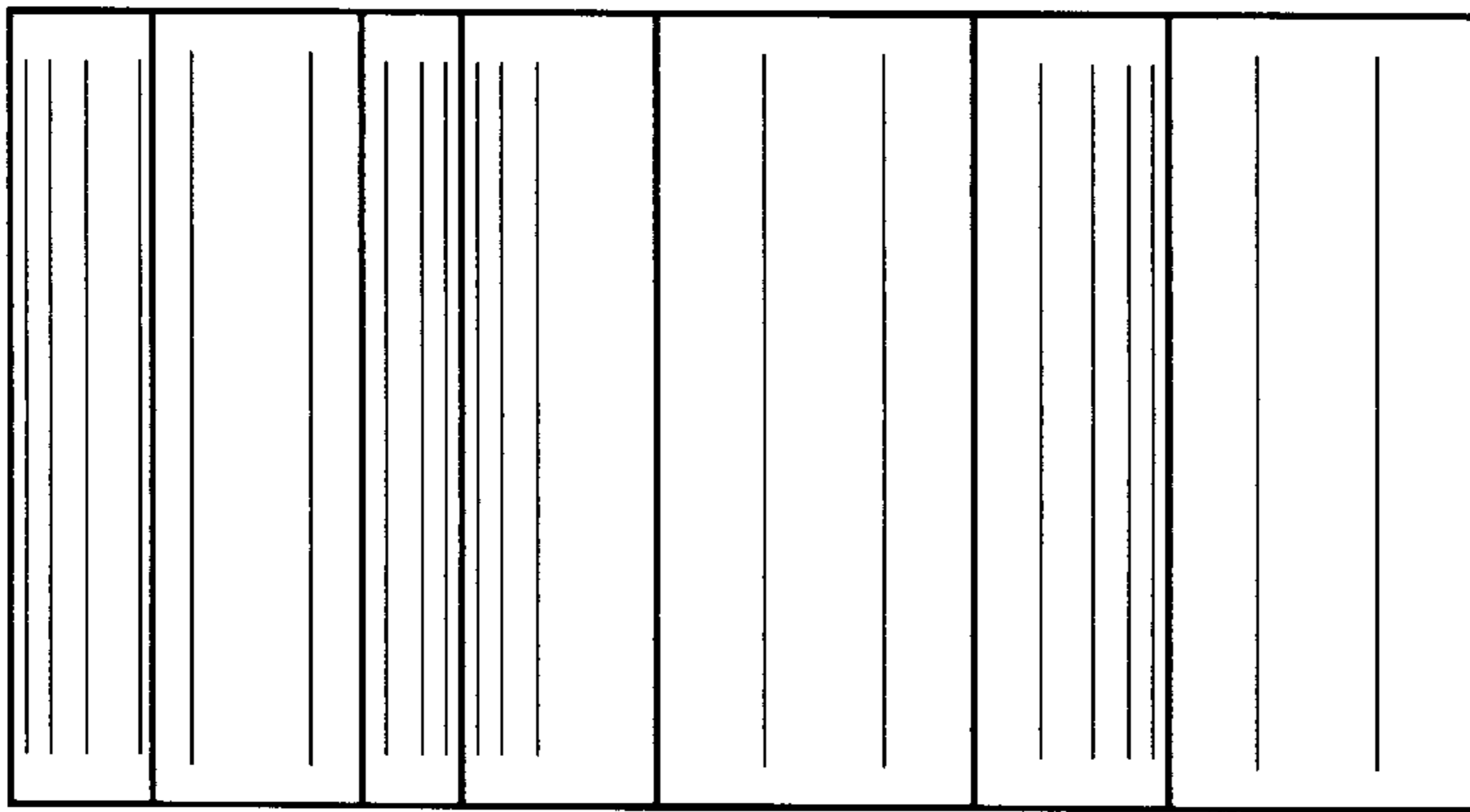

Figure 4

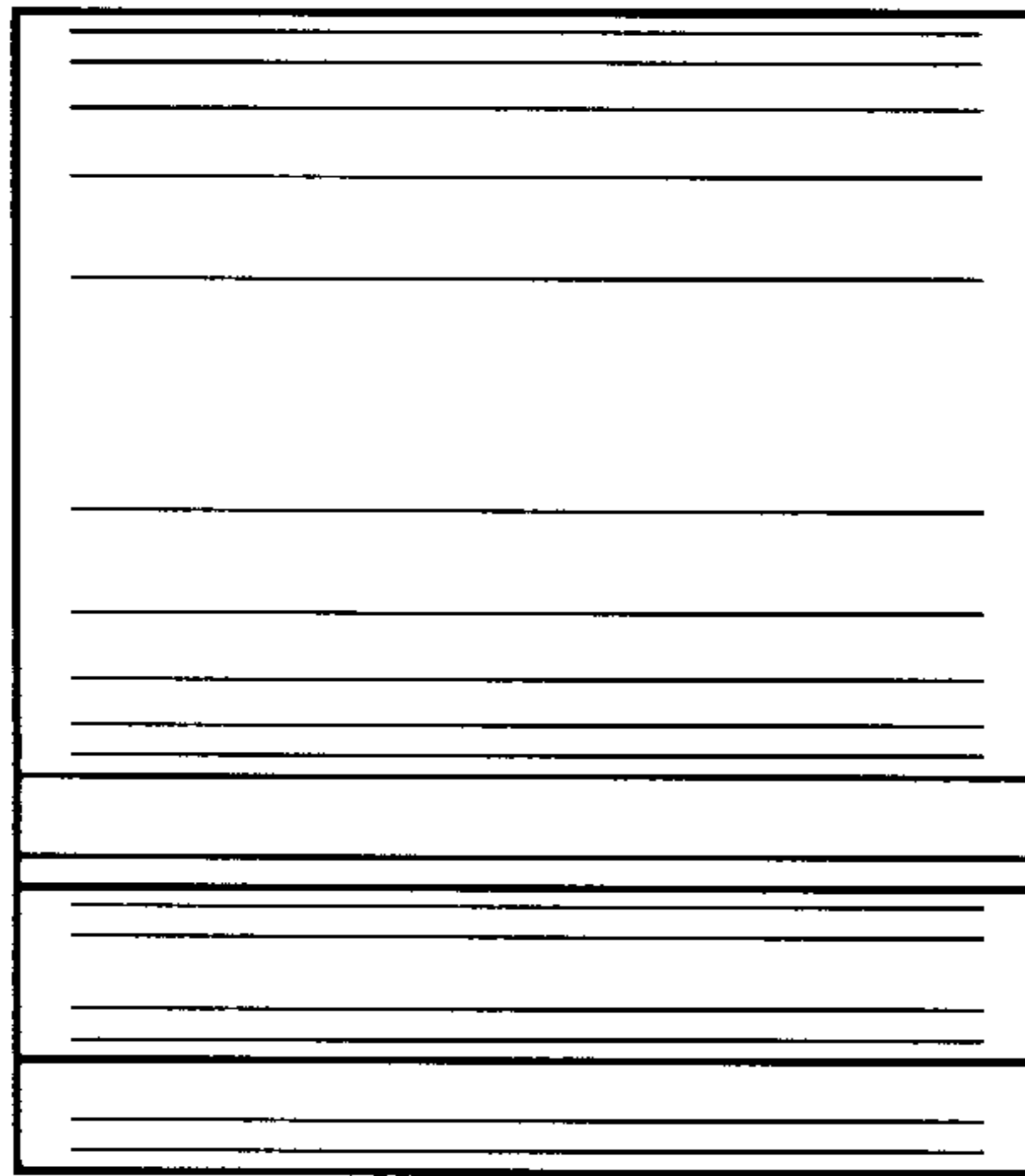

Figure 6