



US00D400993S

# United States Patent [19] Adjeleian

[11] **Patent Number: Des. 400,993**

[45] **Date of Patent: \*\*Nov. 10, 1998**

[54] **DETACHABLE DOCUMENT HOLDER FOR A FLASHLIGHT**

4,739,457 4/1988 Orr .  
5,448,457 9/1995 Ajeleian .

[76] Inventor: **Michael Adjeleian**, 9 York Street,  
Ottawa, Ontario, Canada, K1N 5S7

[\*\*] Term: **14 Years**

[21] Appl. No.: **71,488**

[22] Filed: **May 30, 1997**

[51] **LOC (6) Cl.** ..... **26-02**

[52] **U.S. Cl.** ..... **D26/38**

[58] **Field of Search** ..... D19/90, 91, 99,  
D19/100; D26/38, 49; 362/157, 158, 102,  
109, 110, 120, 183-208

[56] **References Cited**

**U.S. PATENT DOCUMENTS**

D. 318,337	7/1991	Taylor et al.	.....	D26/38
D. 322,681	12/1991	Yuen	.....	D26/38
D. 342,280	12/1993	Revis	.....	D26/38
D. 359,744	6/1995	Peaney et al.	.....	D26/38
2,685,638	8/1954	Littrell .		
2,779,865	1/1957	Hermeyer .		
3,309,514	3/1967	Levy .		

**FOREIGN PATENT DOCUMENTS**

300947 10/1917 Germany .  
287015 3/1928 United Kingdom .

*Primary Examiner*—Marcus A. Jackson  
*Attorney, Agent, or Firm*—Bruce Jacobs; Diderico Van Eyl

[57] **CLAIM**

I claim the ornamental design for the detachable document holder for a flashlight, as shown and described.

**DESCRIPTION**

FIG. 1 is a perspective view of a detachable document holder for a flashlight showing my new design, with the broken line showing for illustrative purposes only and forming no part of the claimed design;  
FIG. 2 is a side elevational view thereof; with the opposite side being a mirror image;  
FIG. 3 is a rear elevational view thereof;  
FIG. 4 is a top plan view thereof;  
FIG. 5 is a front elevational view thereof; and,  
FIG. 6 is a bottom plan view thereof.

**1 Claim, 2 Drawing Sheets**

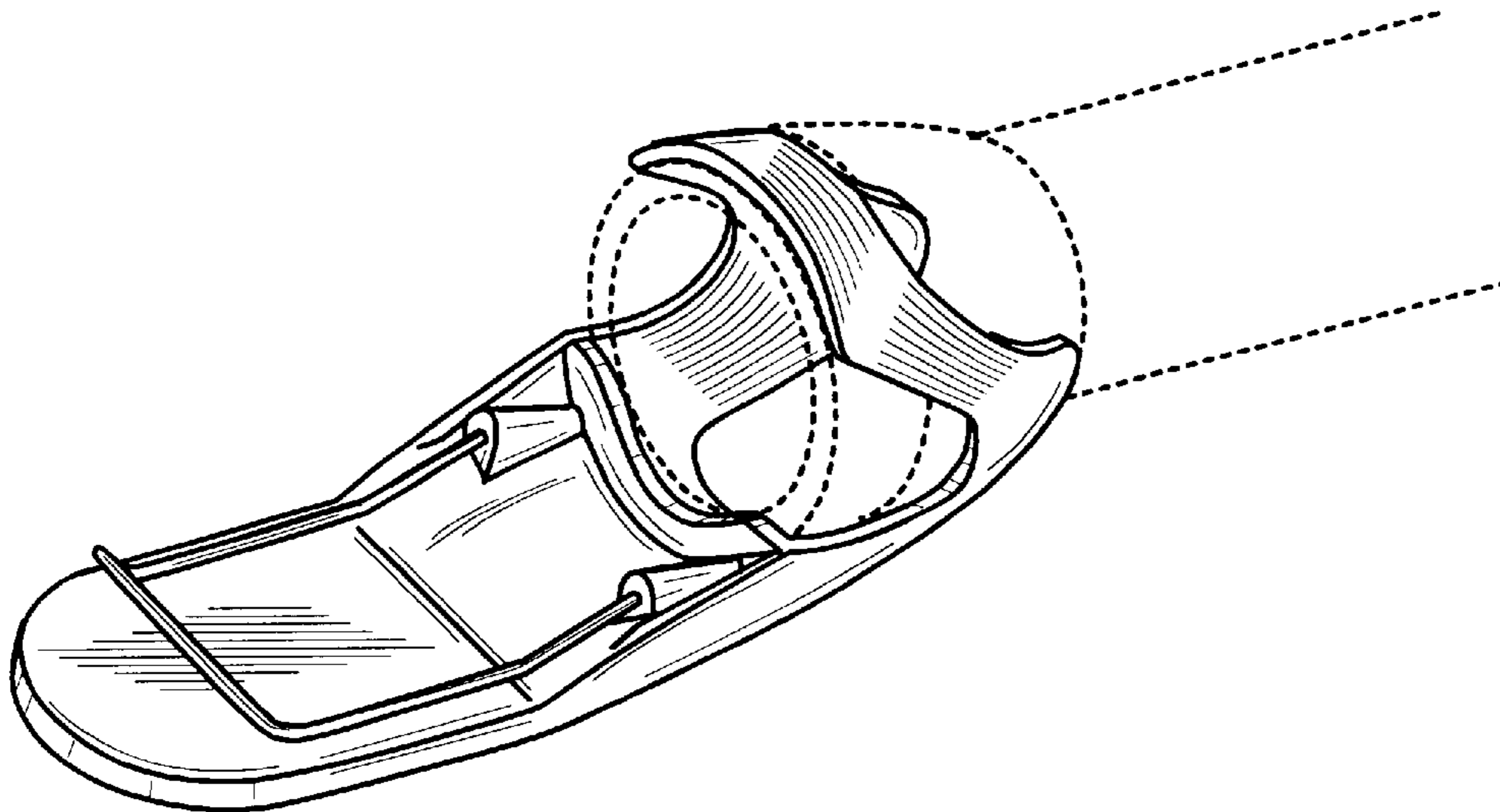

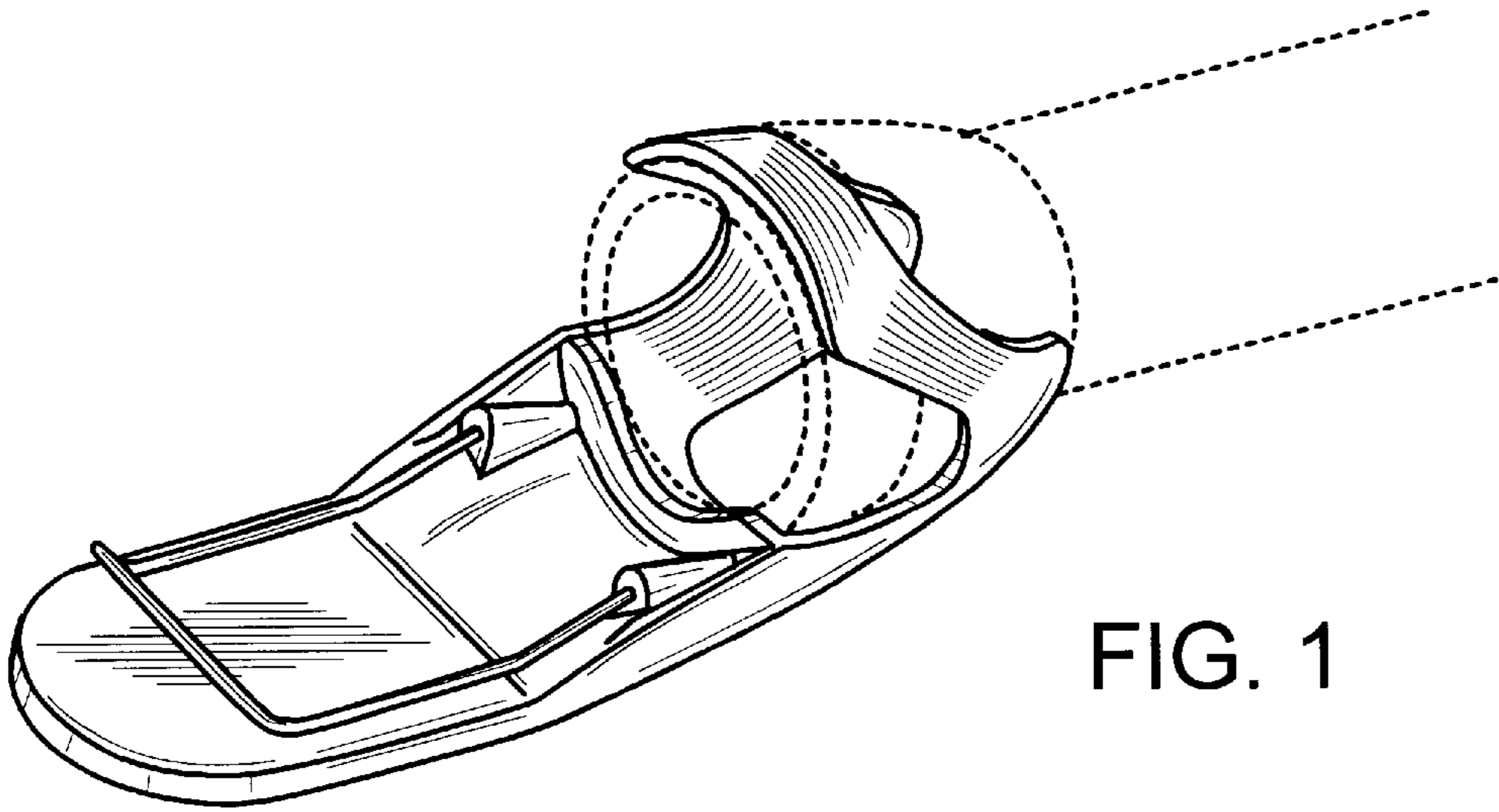

FIG. 1

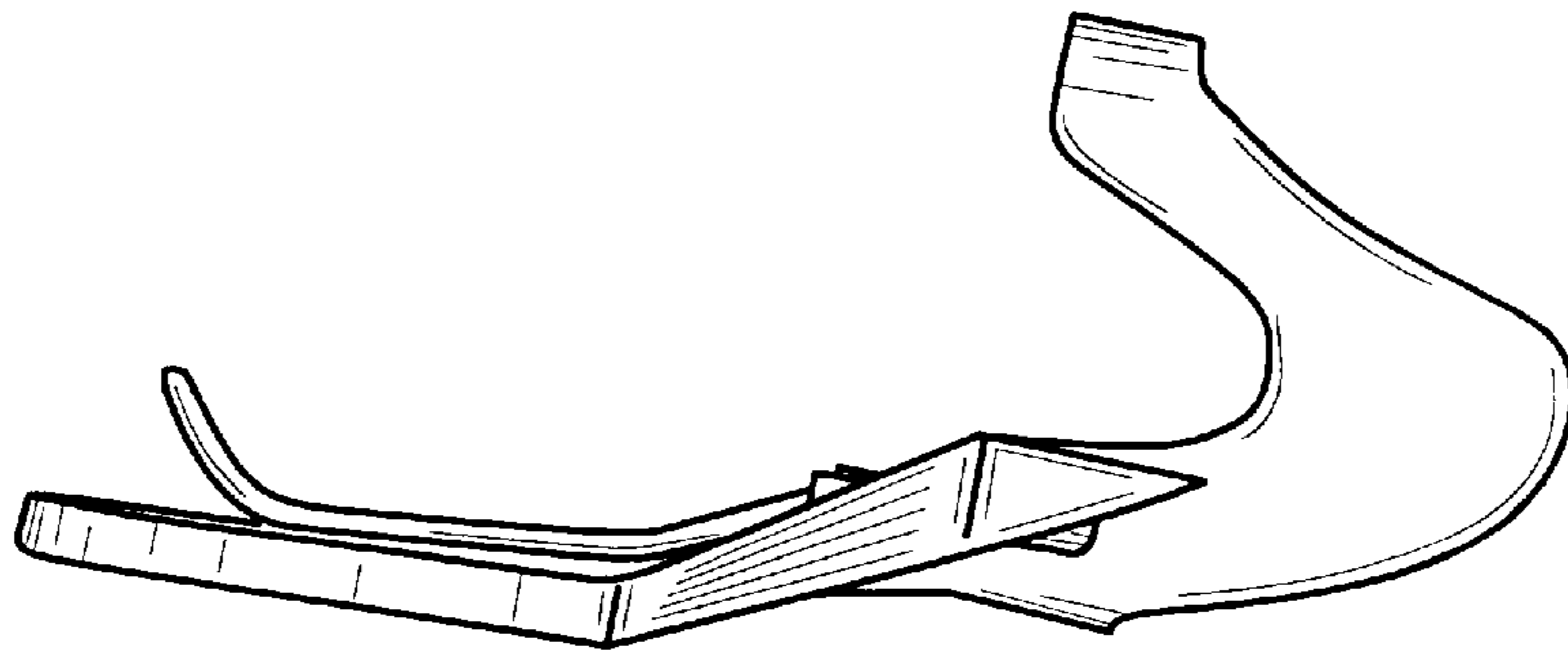

FIG. 2

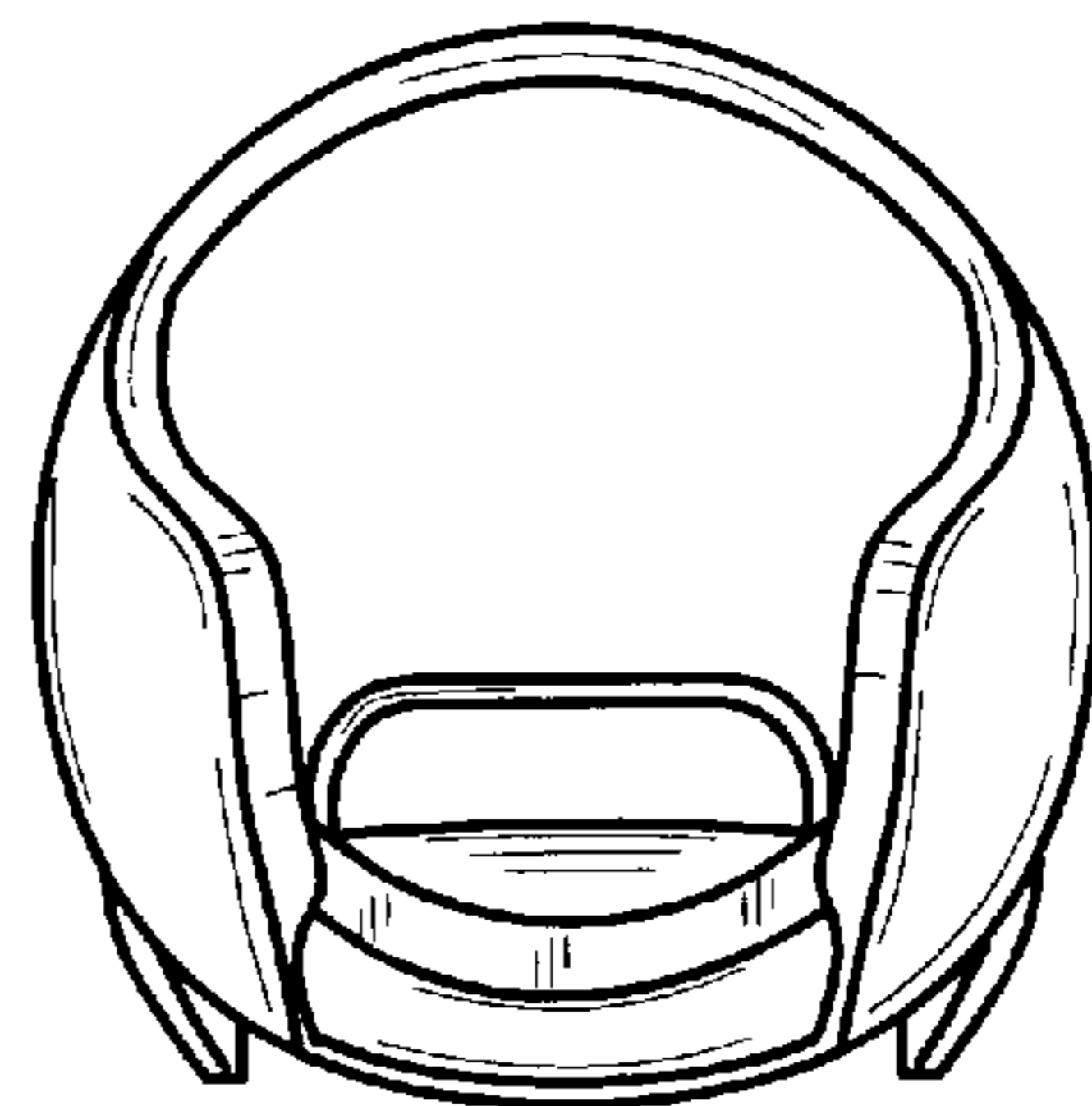

FIG. 3

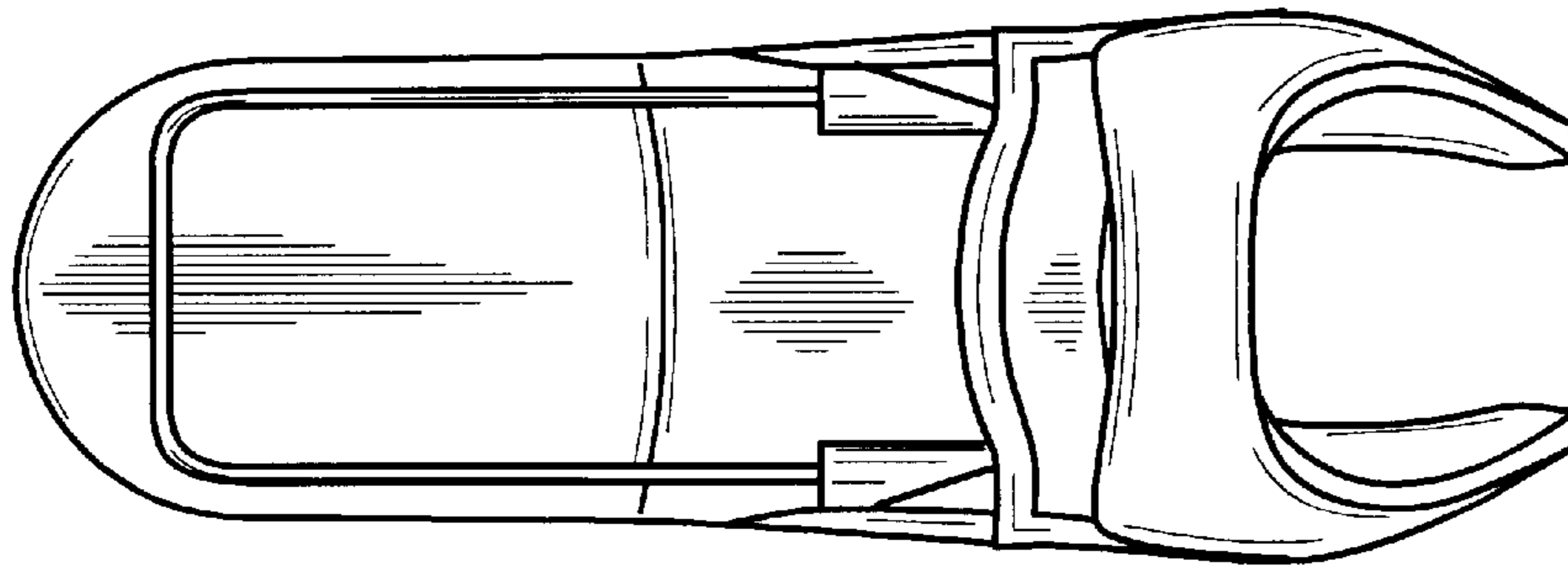

FIG. 4

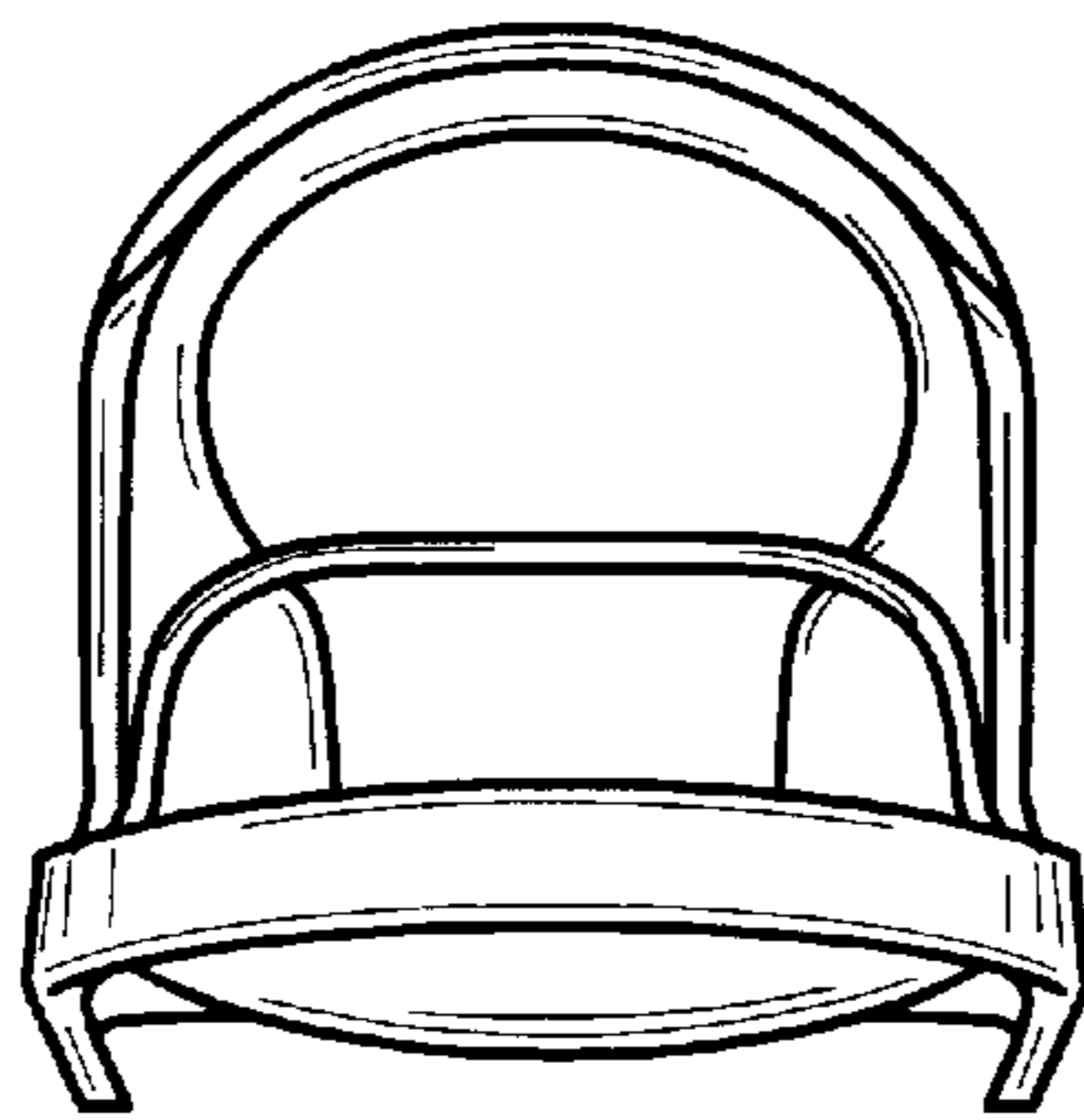

FIG. 5

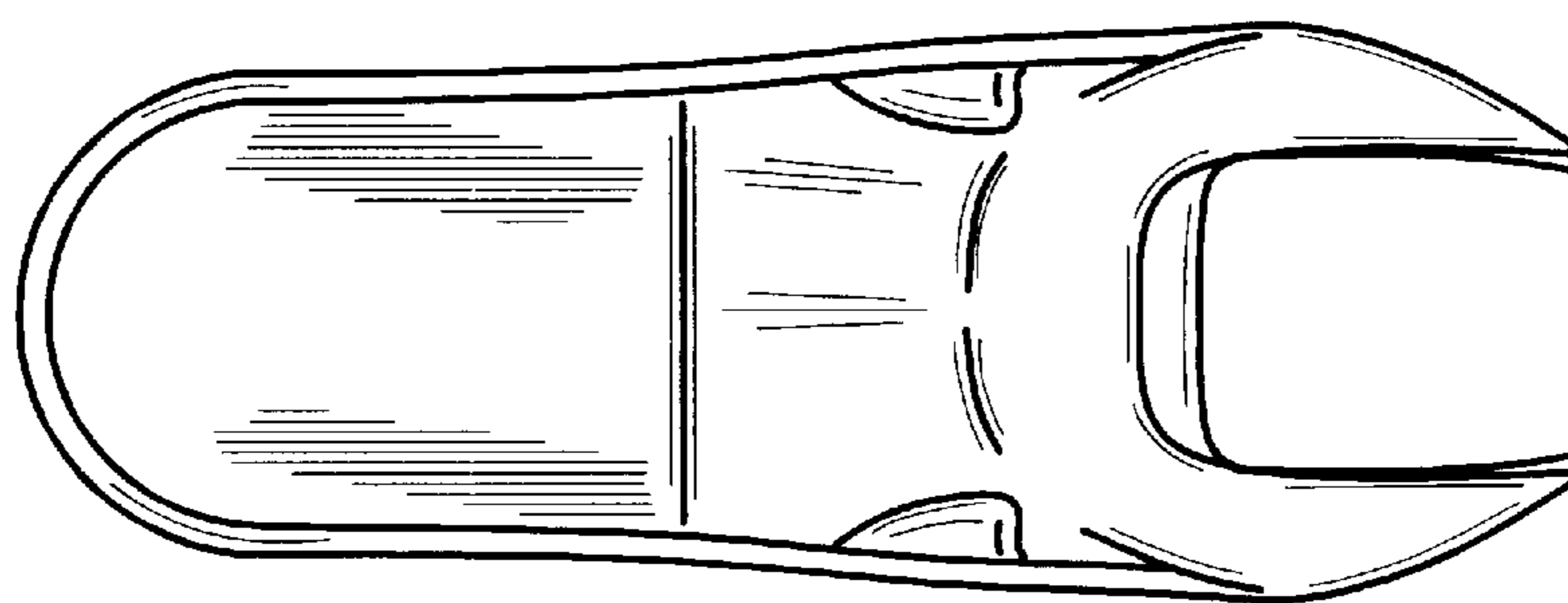

FIG. 6