



US00D400942S

**United States Patent** [19]  
**Billings**

[11] **Patent Number: Des. 400,942**

[45] **Date of Patent: \*\*Nov. 10, 1998**

[54] **OVERSIZED Mallet Putter Head**

D. 384,124 9/1997 Lamanna ..... D21/219  
5,683,397 11/1997 Rife ..... 473/350

[76] Inventor: **David P. Billings**, 12021 Plano Rd.,  
Suite 175, Dallas, Tex. 75243

*Primary Examiner*—Sandra L. Morris  
*Assistant Examiner*—Mitchell I. Siegel  
*Attorney, Agent, or Firm*—David H. Judson

[\*\*] Term: **14 Years**

[21] Appl. No.: **70,442**

[57] **CLAIM**

[22] Filed: **May 8, 1997**

The ornamental design for an oversized mallet putter head,  
as shown and described.

[51] **LOC (6) Cl.** ..... **21-02**

**DESCRIPTION**

[52] **U.S. Cl.** ..... **D21/219**

[58] **Field of Search** ..... D21/217-219;  
473/324, 340, 341, 350

FIG. 1 is a perspective view of the oversized mallet putter head;  
FIG. 2 is a side view of the oversized mallet putter head;  
FIG. 3 is a rear view of the mallet putter head;  
FIG. 4 is a front view of the mallet putter head;  
FIG. 5 is a side view of the mallet putter head;  
FIG. 6 is a top plan view of the mallet putter head; and,  
FIG. 7 is a bottom plan view of the mallet putter head.

[56] **References Cited**

**U.S. PATENT DOCUMENTS**

D. 256,262	8/1980	Benson	.....	D21/219
D. 300,444	3/1989	Antonious	.....	D21/217
D. 350,998	9/1994	Wooten	.....	D21/217
D. 368,751	4/1996	Rife	.....	D21/219

**1 Claim, 2 Drawing Sheets**

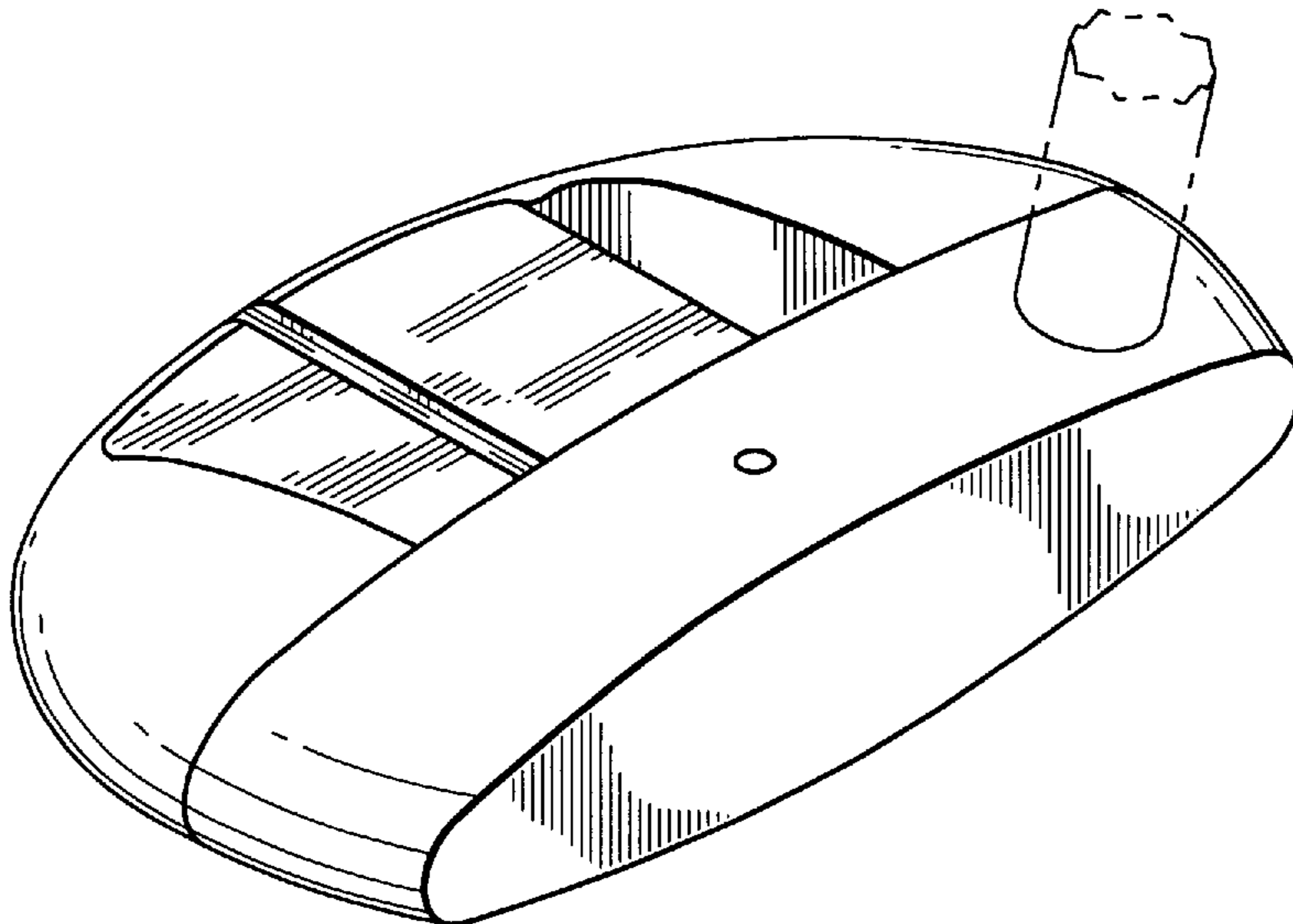

FIG. 1

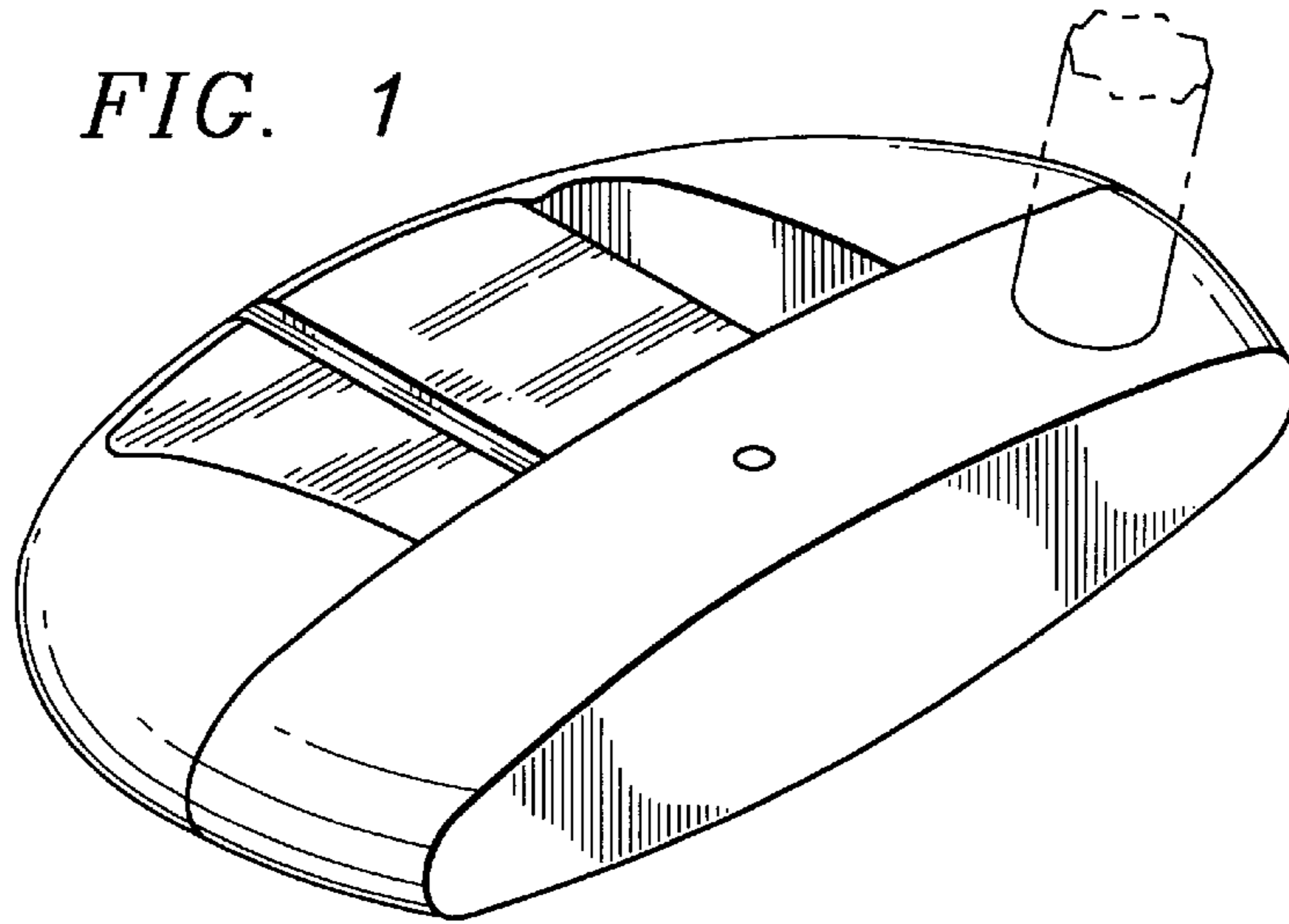

FIG. 2

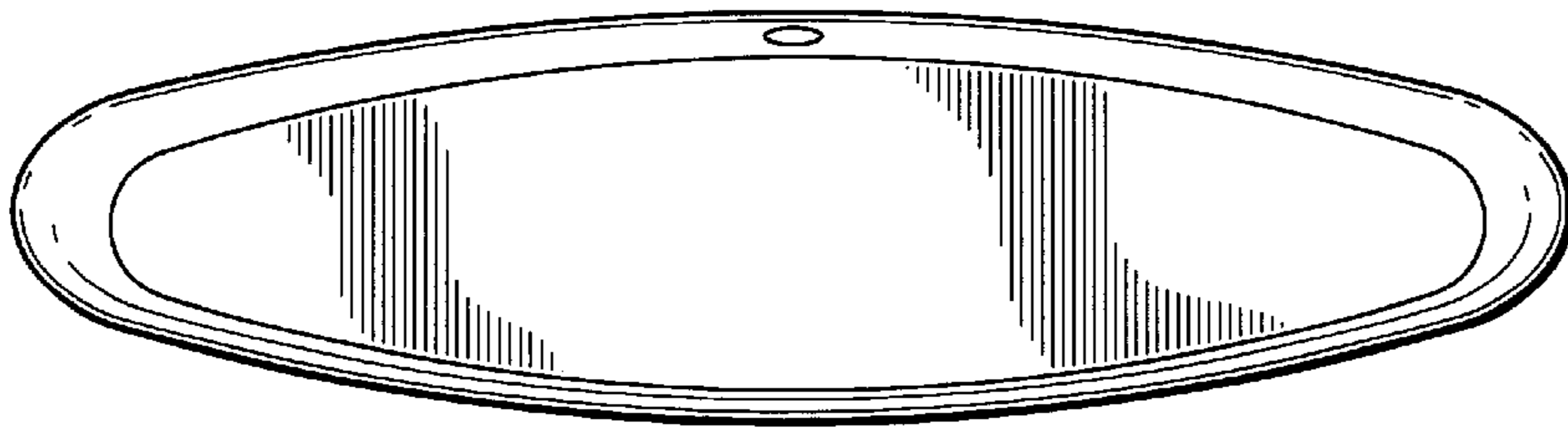

FIG. 3

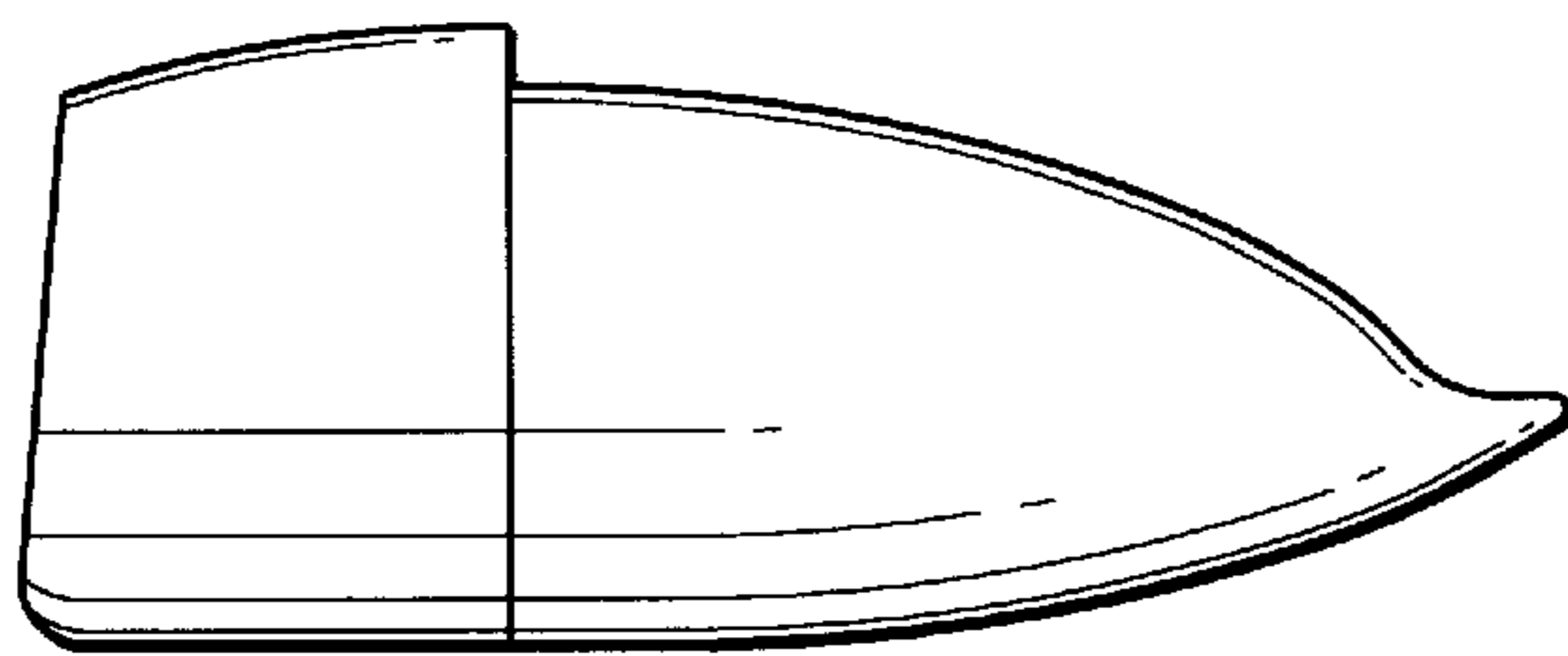
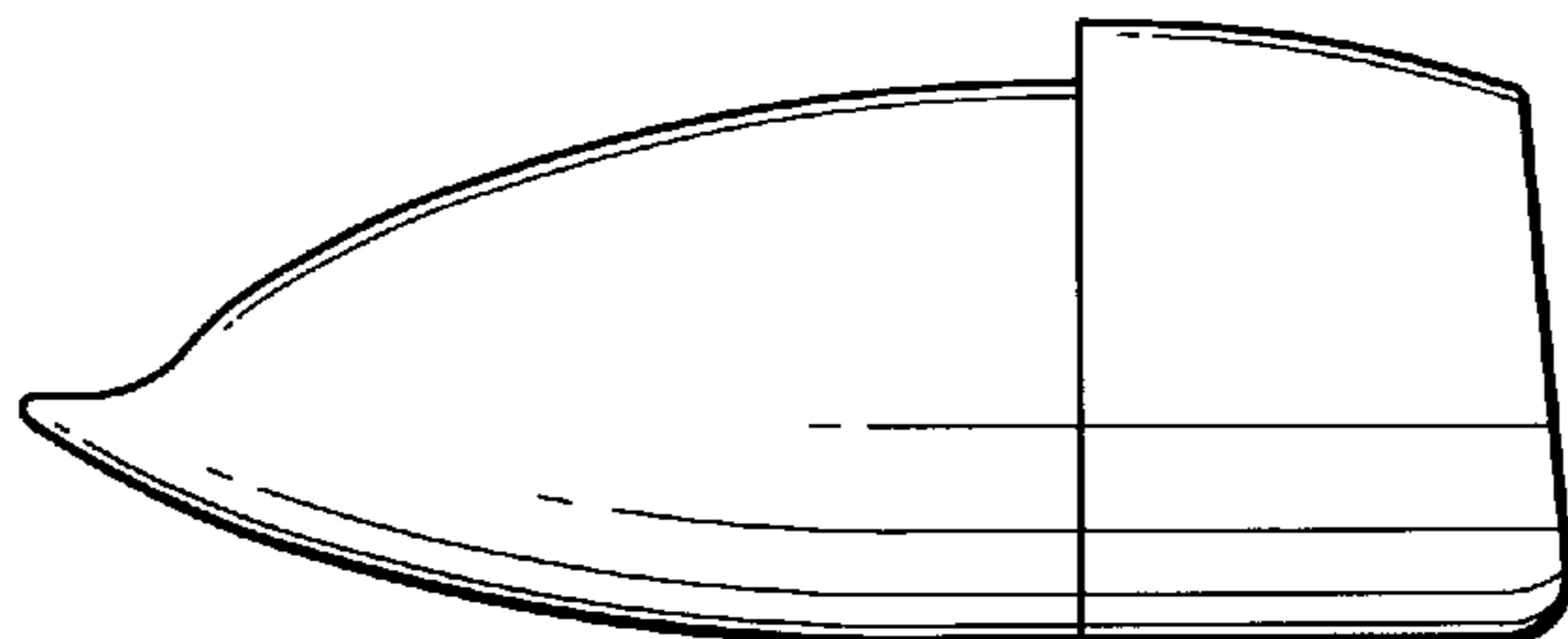

FIG. 4



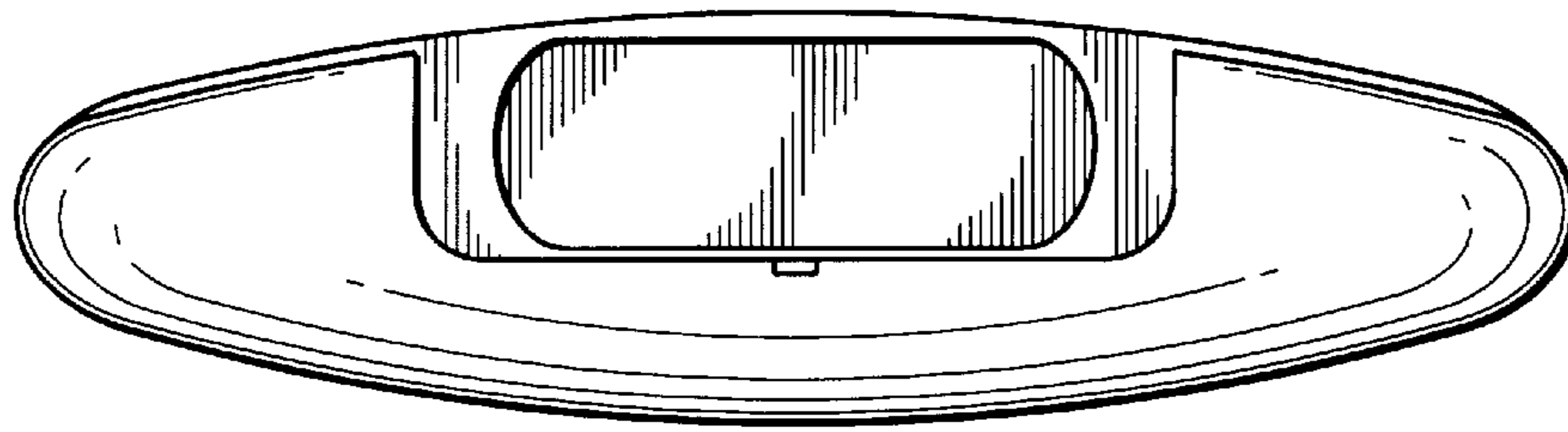

FIG. 5

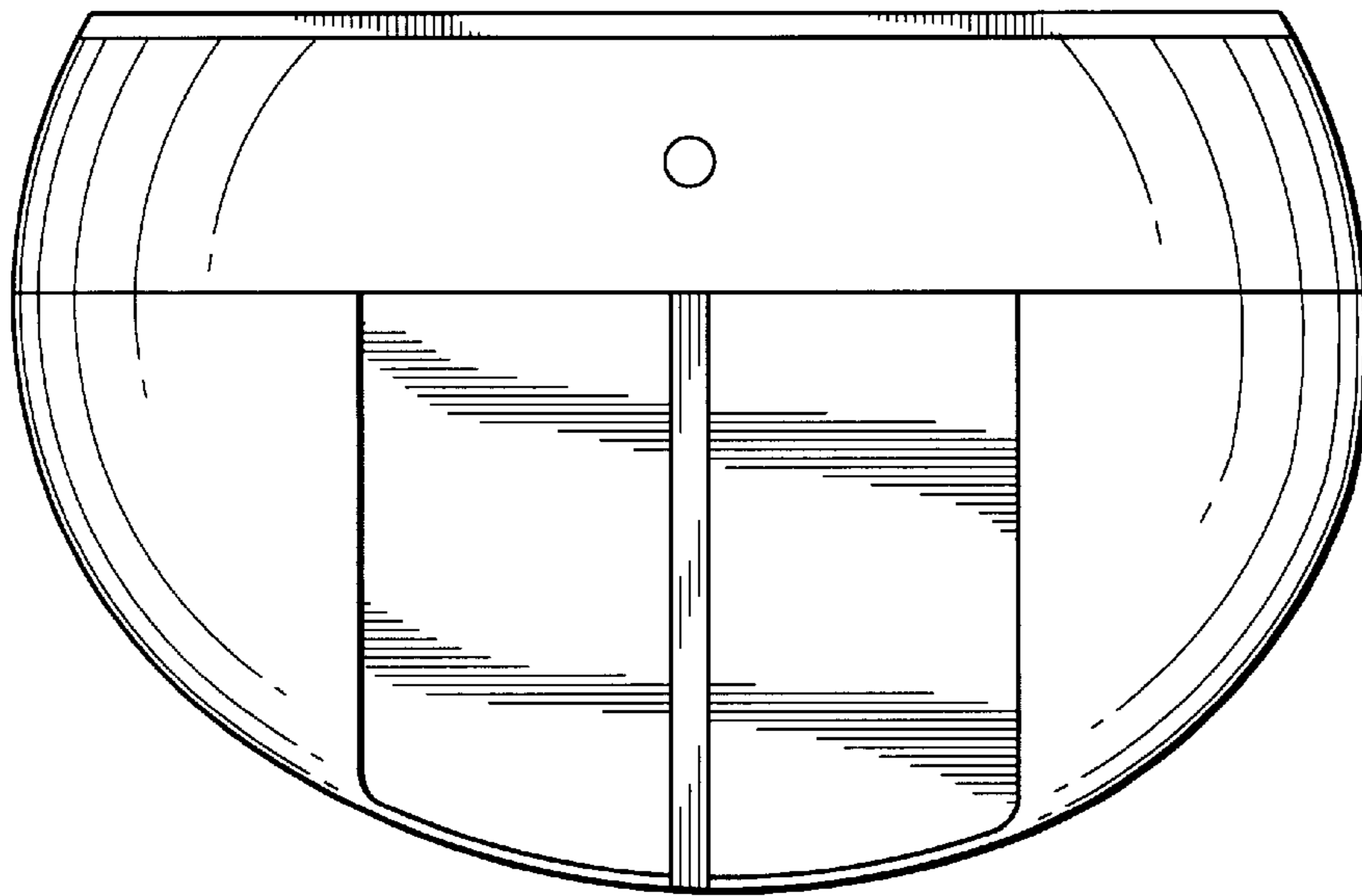

FIG. 6

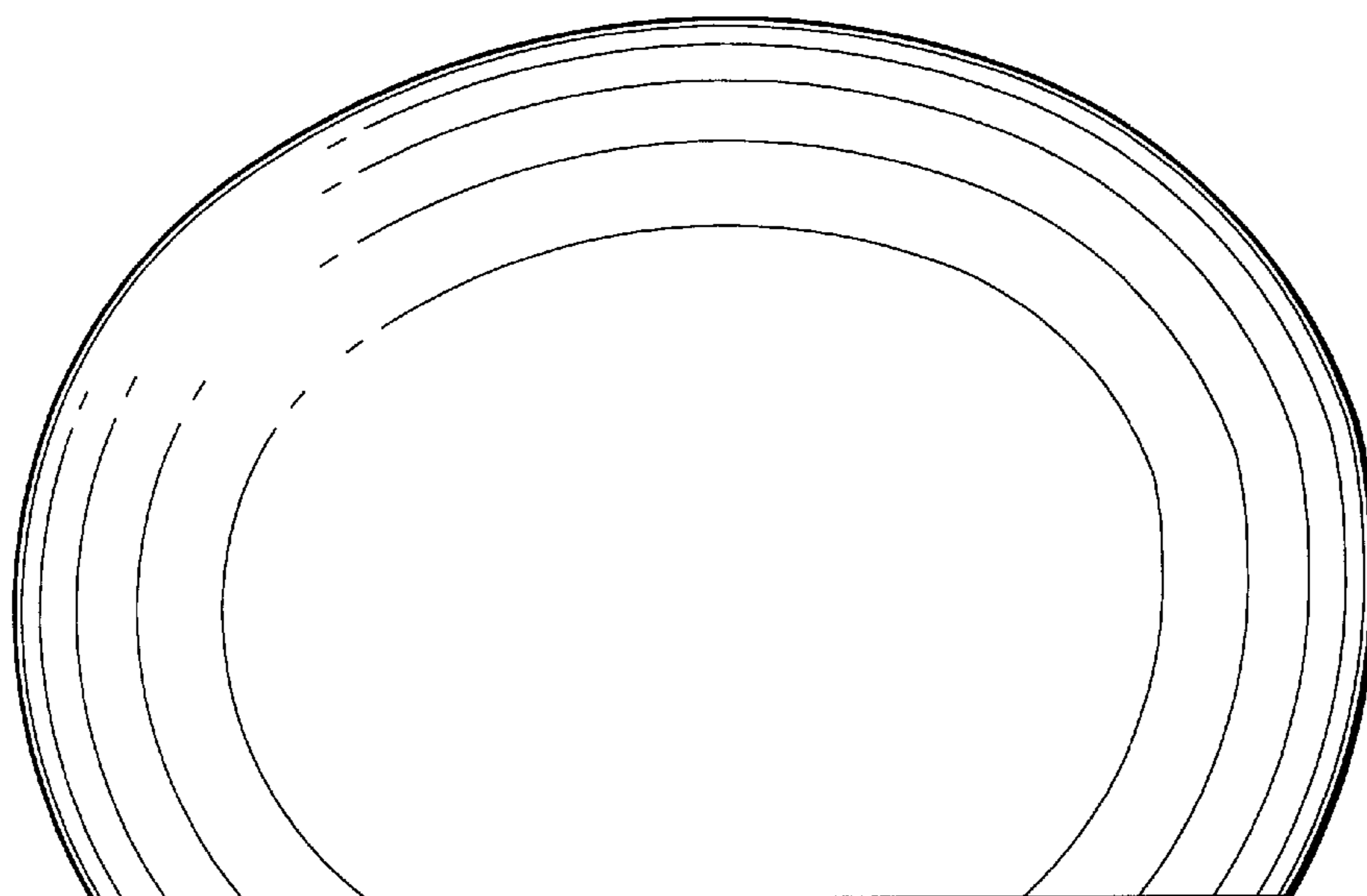

FIG. 7