



US00D400794S

# United States Patent [19]

[11] **Patent Number: Des. 400,794**

**Takeuchi et al.**

[45] **Date of Patent: \*\*Nov. 10, 1998**

[54] **BOTTLE FOR PACKAGING**

3,412,887 11/1968 Swartwood et al. .... 215/397

[75] Inventors: **Setsuyuki Takeuchi; Nobukuni Ibe,**  
both of Nagano-ken, Japan

*Primary Examiner*—Lucy Lieberman  
*Attorney, Agent, or Firm*—Weingarten, Schurgin, Gagnebin  
& Hayes LLP

[73] Assignee: **A. K. Technical Laboratory, Inc.,**  
Nagano-ken, Japan

## [57] CLAIM

[\*\*] Term: **14 Years**

The ornamental design for a bottle for packaging, as shown  
and described.

[21] Appl. No.: **73,275**

## DESCRIPTION

[22] Filed: **Jul. 17, 1997**

FIG. 1 is a top front, and right side view of our new design  
for a bottle for packaging;

[51] **LOC (6) Cl. .... 09-01**

FIG. 2 is a front view thereof;

[52] **U.S. Cl. .... D9/532; D9/570**

FIG. 3 is a top plan view thereof;

[58] **Field of Search .... D9/532, 570, 557,**  
D9/560, 531, 536, 571, 542, 573; 215/397,  
382-384

FIG. 4 is a right side elevation, the left side elevation is a  
mirror image thereto;

FIG. 5 is a bottom view thereof;

FIG. 6 is a back side view thereof;

## [56] References Cited

### U.S. PATENT DOCUMENTS

D. 268,324	3/1983	Gautier	.....	D9/570
D. 292,378	10/1987	Brandt et al.	.....	D9/557
D. 347,391	5/1994	Guertin	.....	D9/566
3,021,973	2/1962	Palme	.....	215/397
3,285,454	11/1966	Bailey	.....	215/397

FIG. 7 is a top plan view when the handle is bent; and,  
FIG. 8 is a right side view when the handle is bent.

The characteristic feature of this design resides in the  
appearance of the handle being integrally formed on the  
neck portion of the bottle and the ribs provided around the  
outer surface of the body portion of the bottle.

**1 Claim, 7 Drawing Sheets**

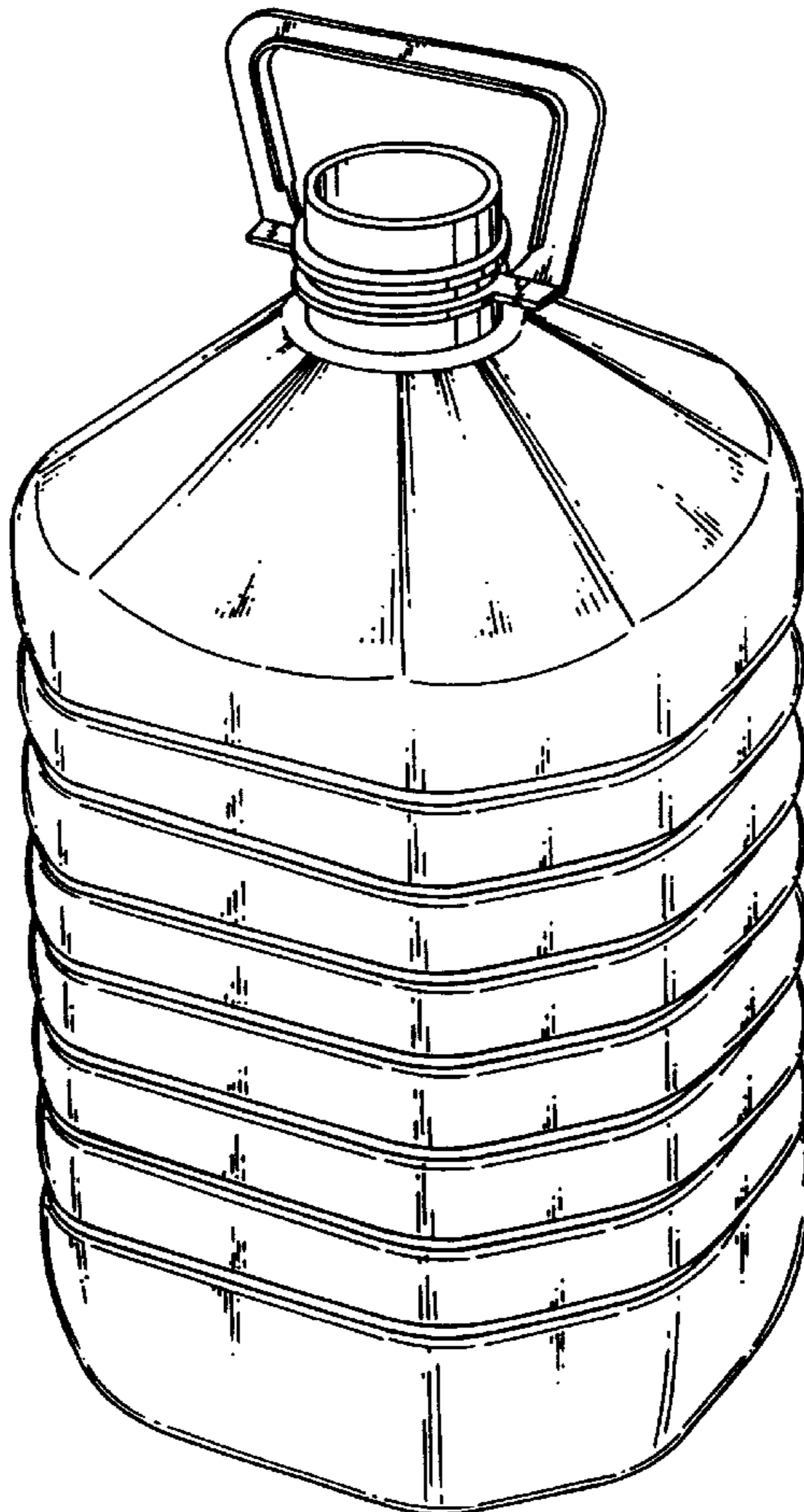

Fig.1

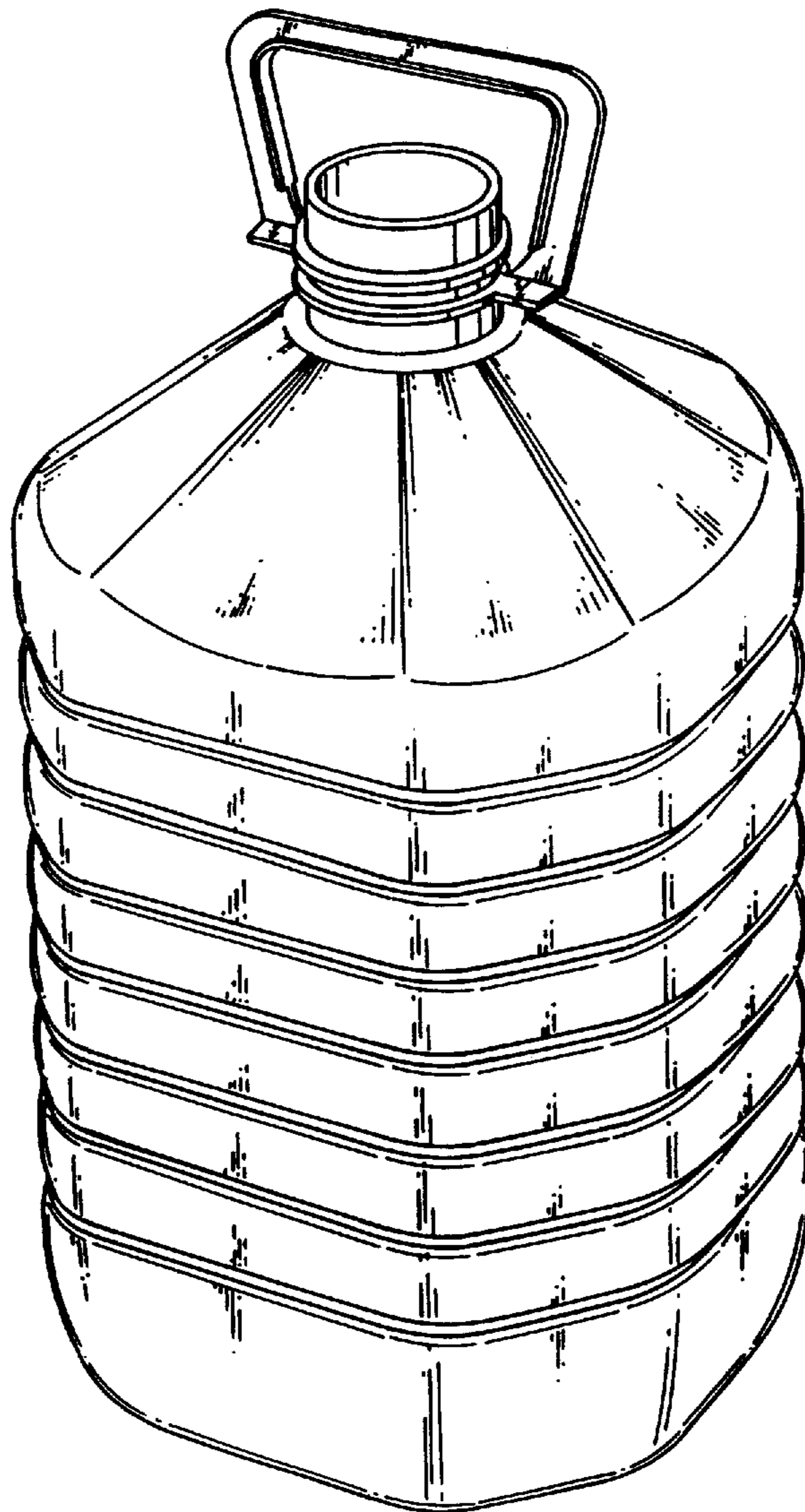

Fig.2

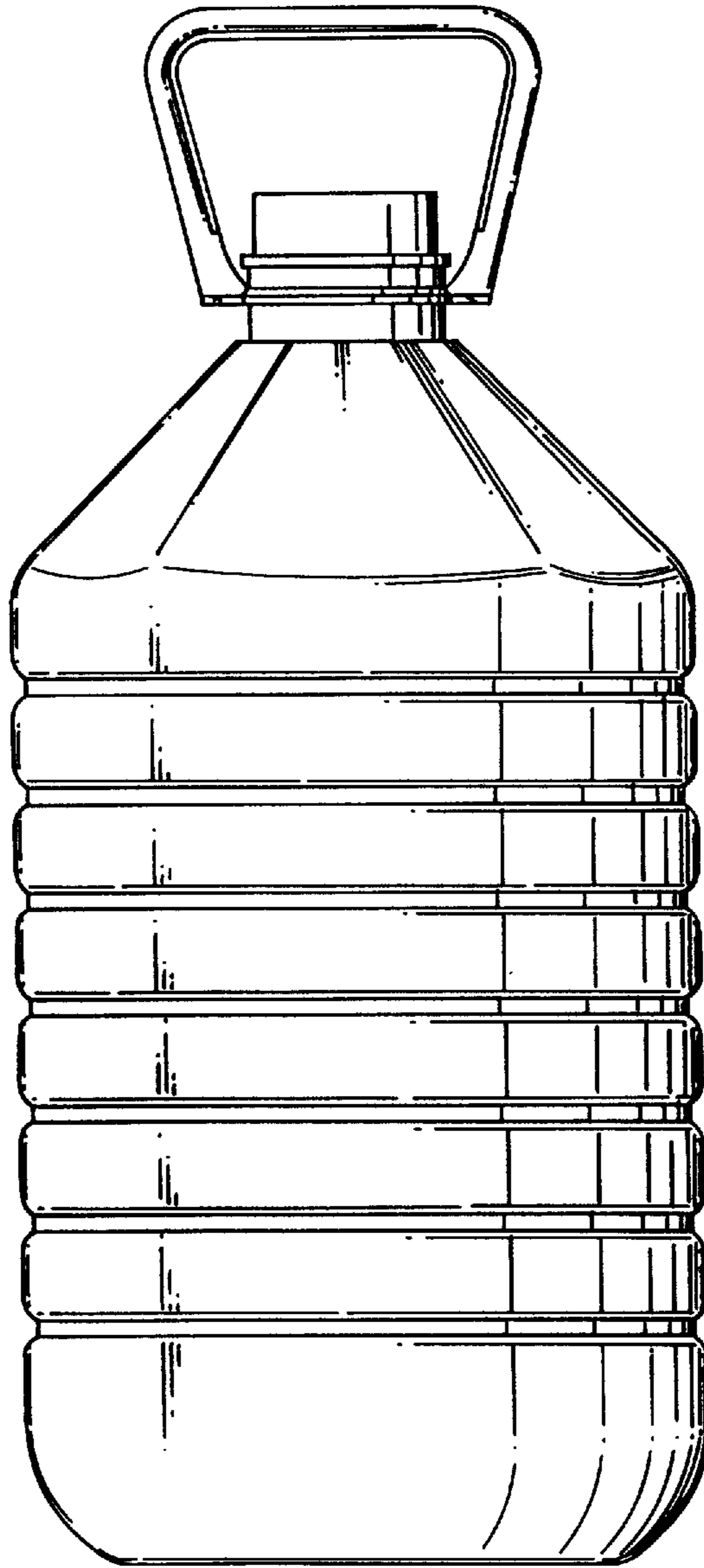

Fig.3

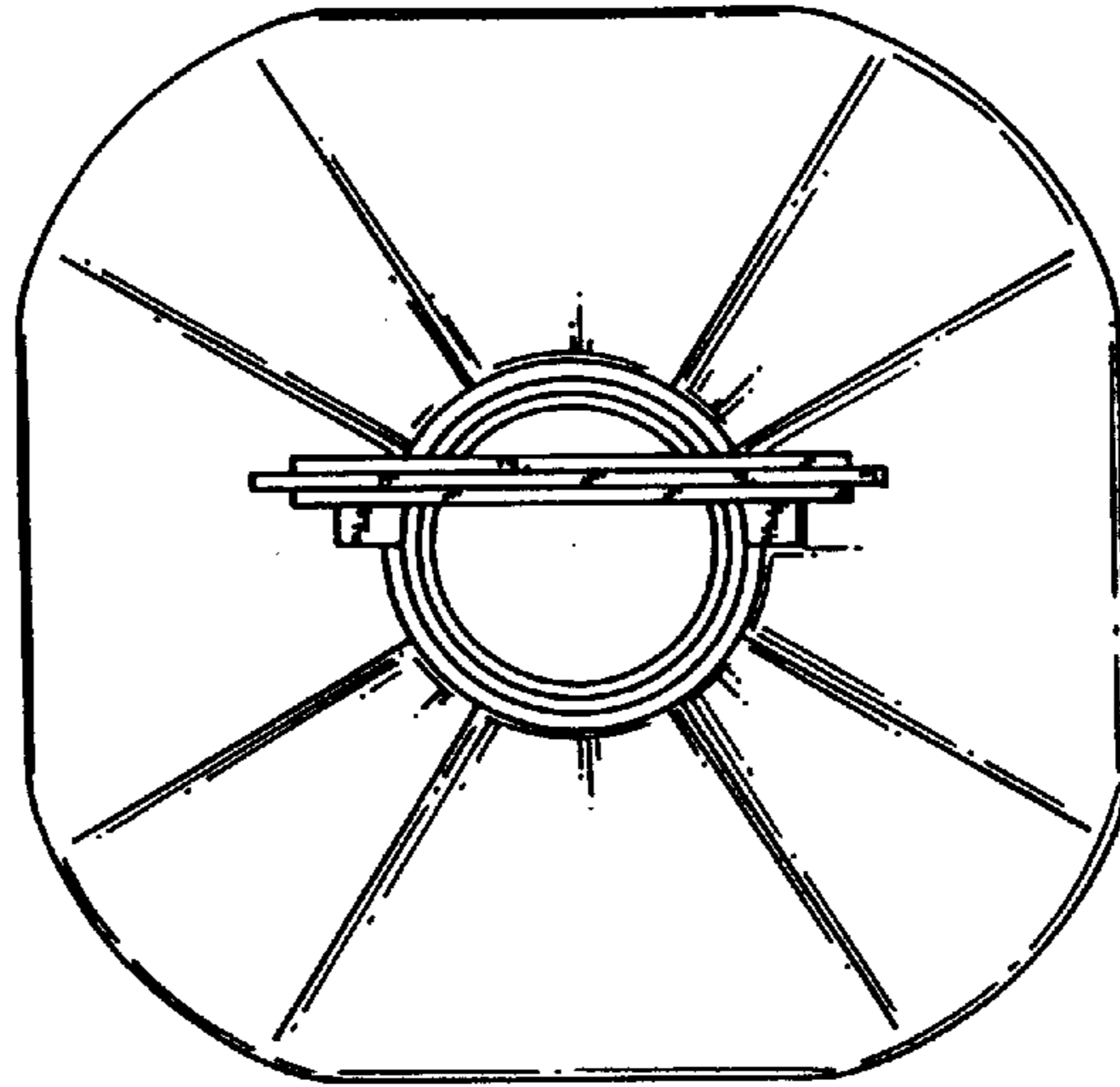

Fig.5

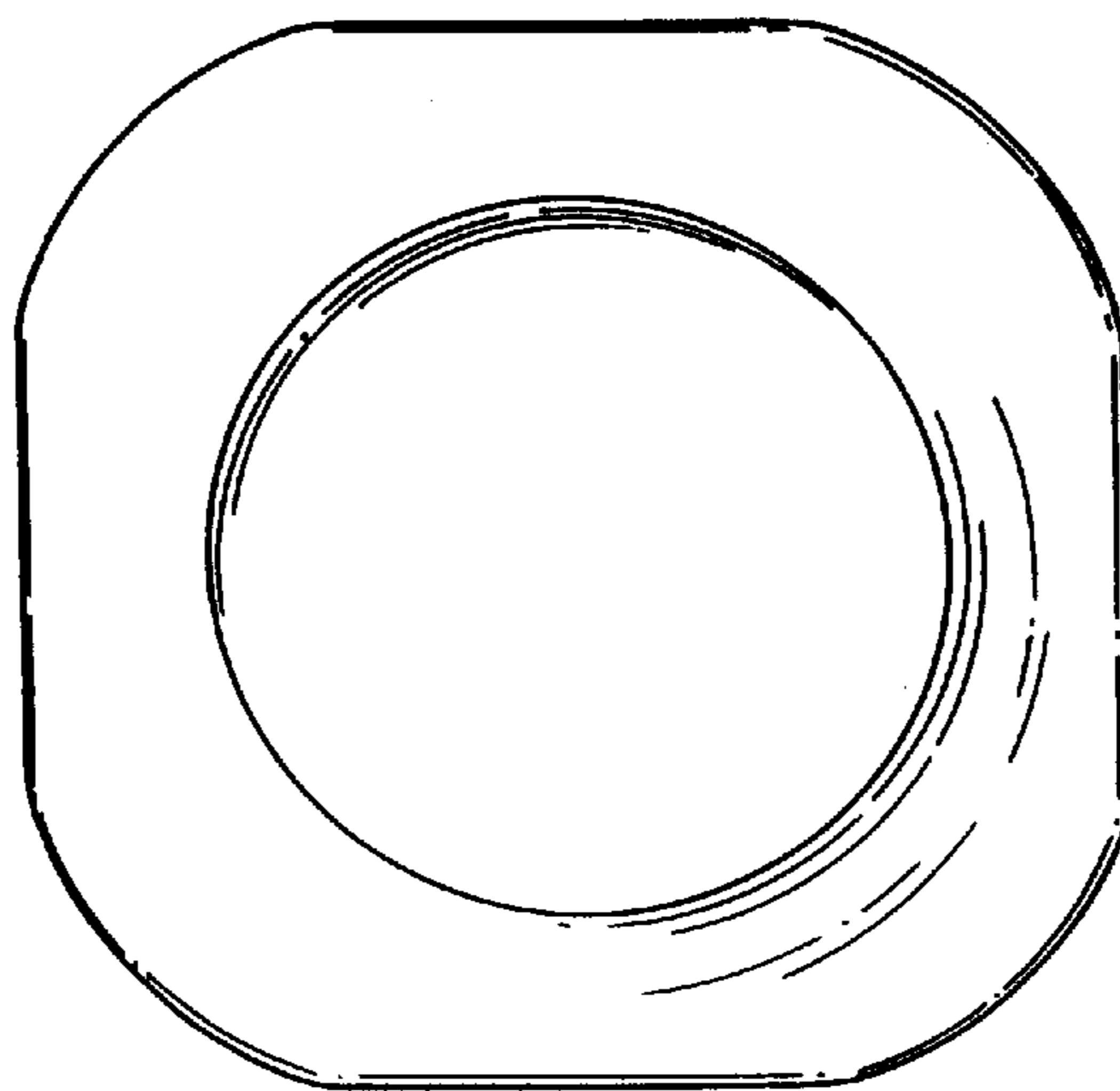

Fig.4

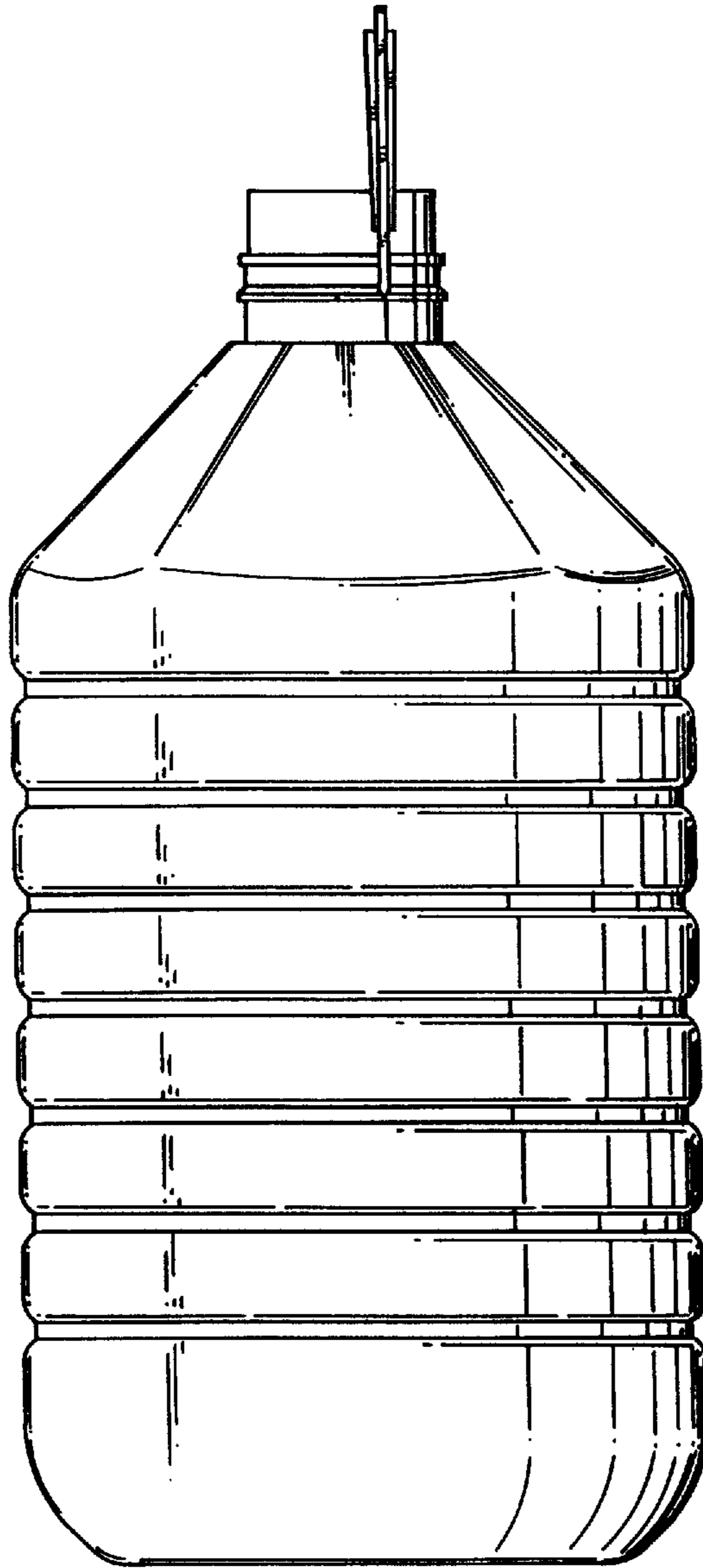

Fig.6

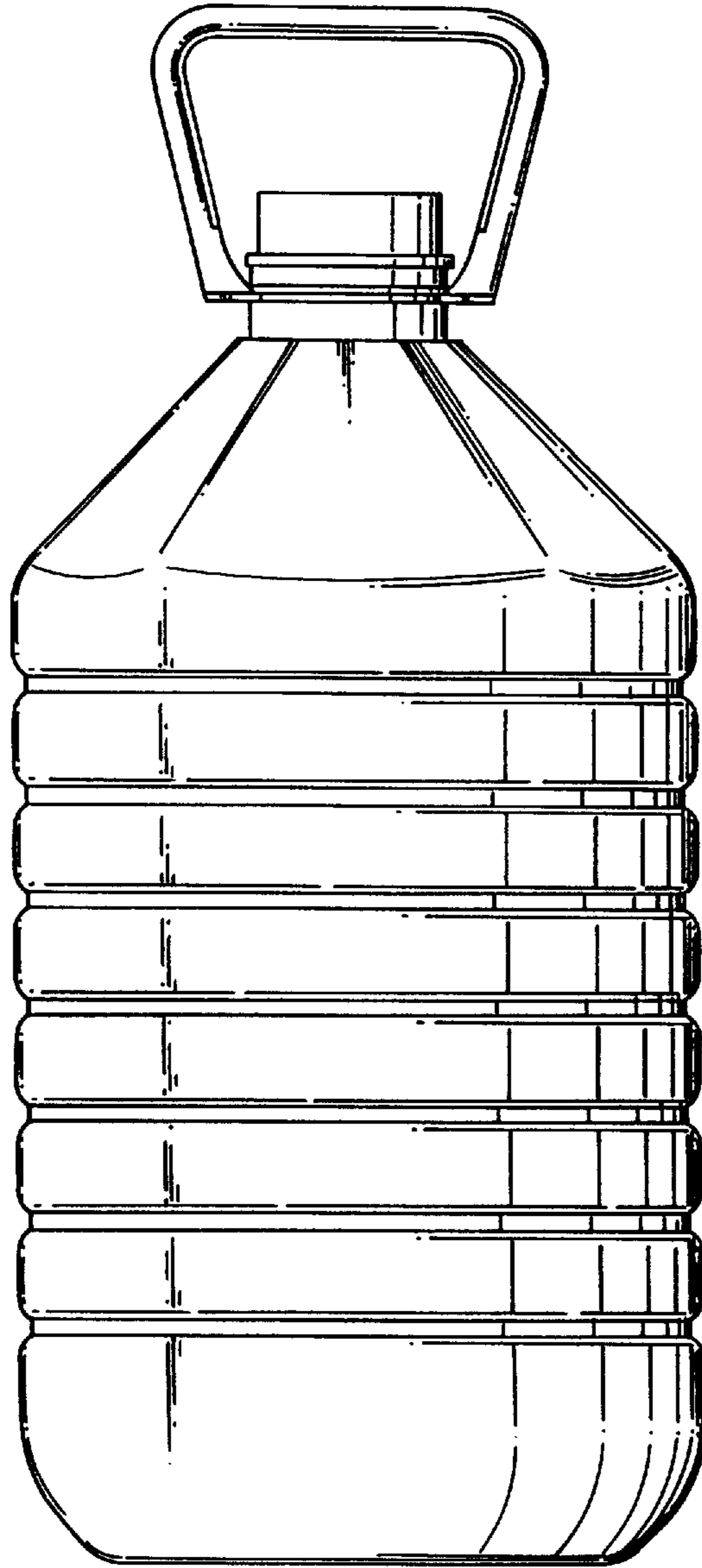



Fig. 7

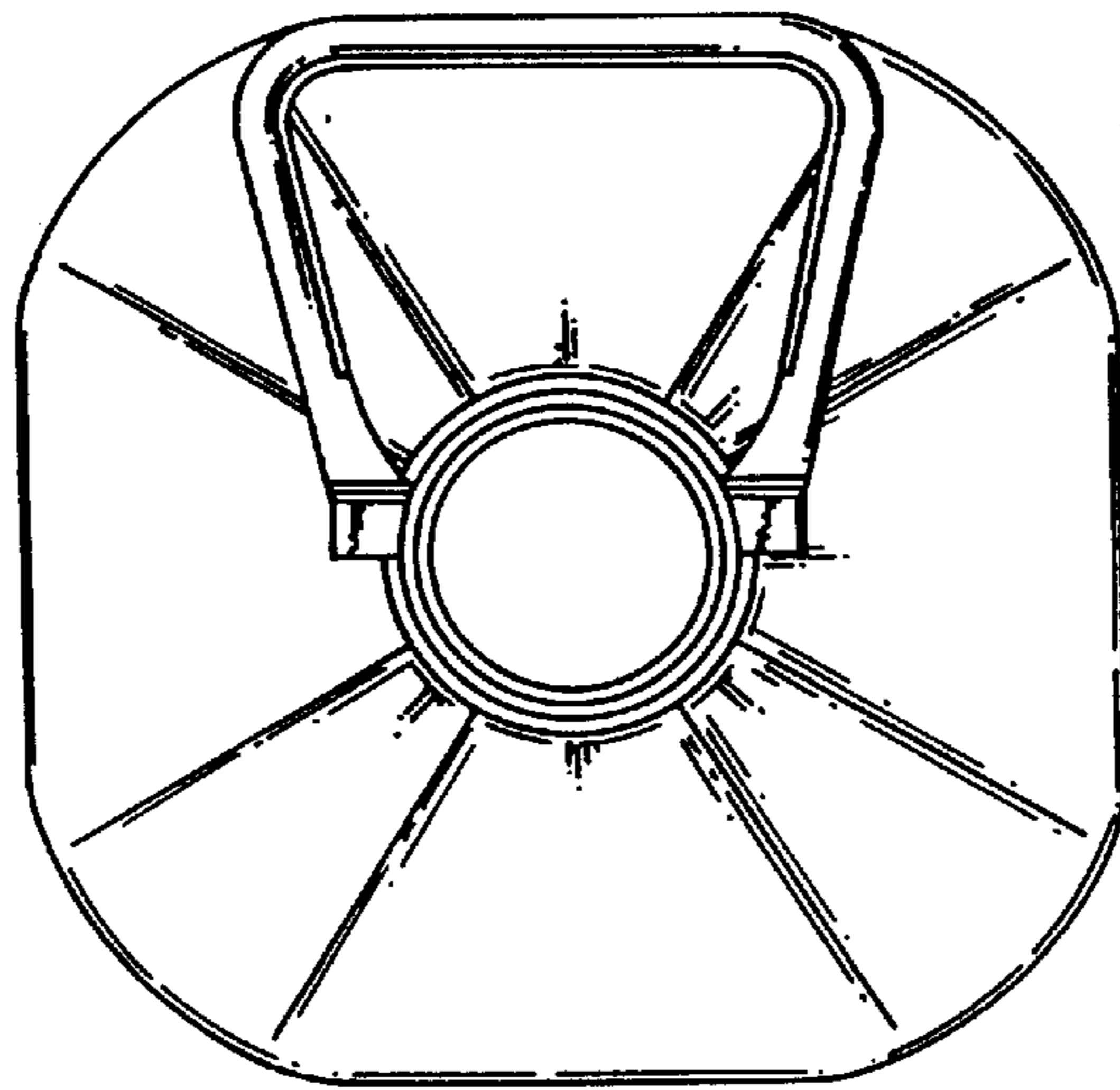
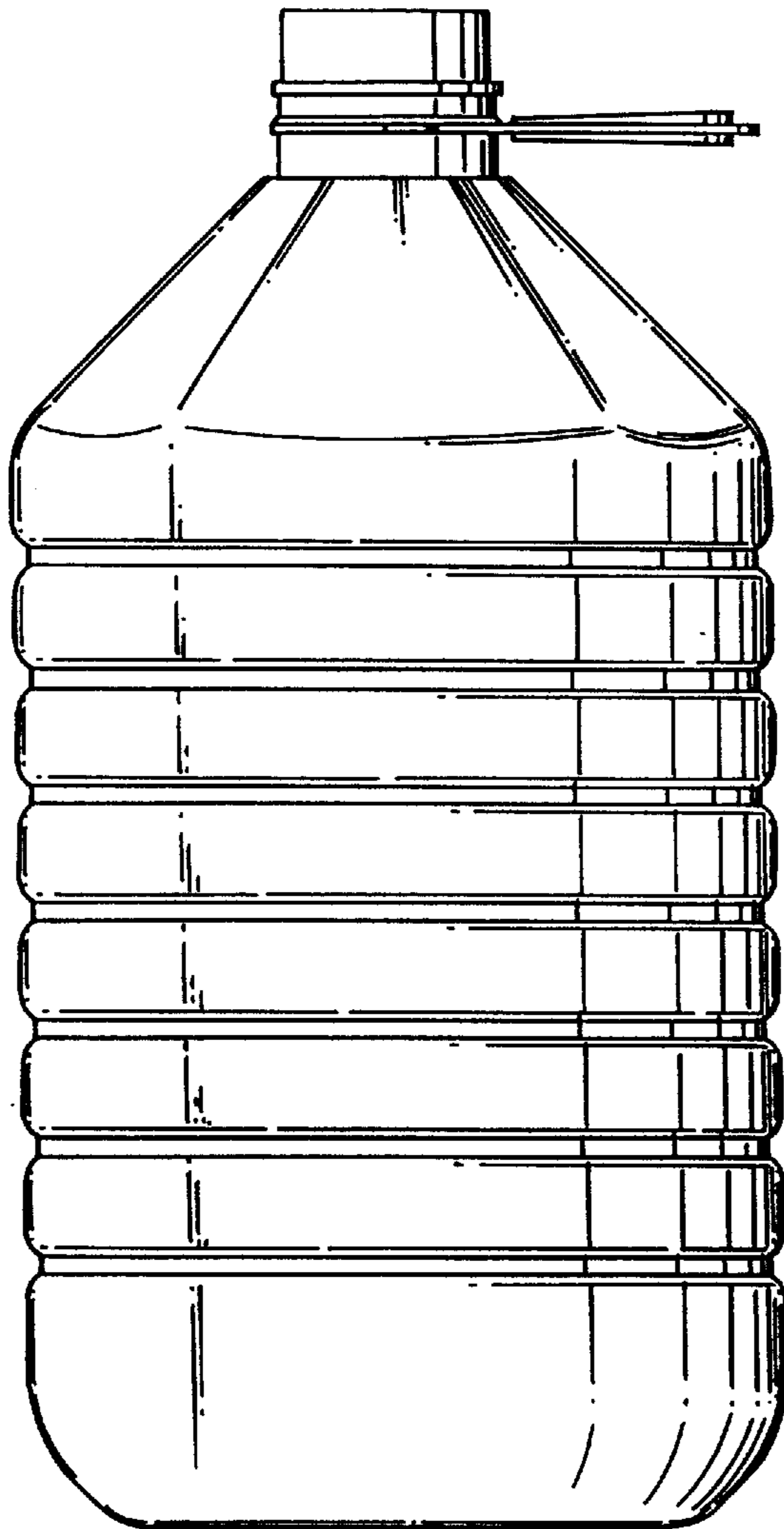

Fig. 8





UNITED STATES PATENT AND TRADEMARK OFFICE  
CERTIFICATE OF CORRECTION

PATENT NO : Des. 400,794  
DATED : November 10, 1998  
INVENTOR(S): Setsuyuki Takeuchi, et al.

It is certified that error appears in the above-identified patent and that said Letters Patent are hereby corrected as shown below:

On the title page, after item [22], insert the following:

FOREIGN APPLICATION PRIORITY DATA:  
January 20, 1997 [JP] Japan 9-1111

In the Description, line 1, "FIG. 1 is a top front, and"  
should read --FIG. 1 is a top, front, and--.

Signed and Sealed this  
Fifteenth Day of February, 2000

Attest:



Q. TODD DICKINSON

Attesting Officer

Commissioner of Patents and Trademarks