



US00D400776S

United States Patent [19]

[11] **Patent Number: Des. 400,776**

Prevot et al.

[45] **Date of Patent: **Nov. 10, 1998**

[54] **HANDLE FOR DOORS AND WINDOWS**

Primary Examiner—B. J. Bullock
Attorney, Agent, or Firm—Young & Thompson

[75] Inventors: **Gérard Prevot**, Willerwald; **Gérard Desplantes**, Sarrebourg, both of France

[57] **CLAIM**

[73] Assignee: **Ferco International Ferrures et Serrures de Batiment**, Reding, France

The ornamental design for a handle for doors and windows, as shown and described.

[**] Term: **14 Years**

DESCRIPTION

[21] Appl. No.: **72,867**

FIG. 1 is a top, front and side perspective view of a handle for doors and windows, showing our new design;

[22] Filed: **Jun. 18, 1997**

FIG. 2 is a front elevational view thereof;

[30] **Foreign Application Priority Data**

FIG. 3 is a rear elevational view thereof;

Dec. 23, 1996 [FR] France 96 7252

FIG. 4 is a side elevational view thereof from the right of FIG. 2;

[51] **LOC (6) Cl.** **08-06**

FIG. 5 is a side elevational view thereof from the left of FIG. 2;

[52] **U.S. Cl.** **D8/301; D8/308**

FIG. 6 is a top plan view thereof;

[58] **Field of Search** D8/300–302, 307, D8/308, 353, 330, 331, 336, 338; 16/110 R; 74/543, 519; 70/452

FIG. 7 is a bottom plan view thereof;

[56] **References Cited**

FIGS. 8–14 are views similar to FIGS. 1–7, respectively, but showing a second embodiment thereof;

U.S. PATENT DOCUMENTS

FIGS. 15–21 are views similar to FIGS. 1–7, respectively, but showing a third embodiment thereof;

- D. 189,524 1/1961 Savage D8/302
- D. 204,088 3/1966 Adler D8/302
- D. 213,863 4/1969 Unter D8/302
- D. 346,105 4/1994 Shaanan D8/301

FIGS. 22–28 are views similar to FIGS. 1–7, respectively, but showing a fourth embodiment thereof;

OTHER PUBLICATIONS

FIGS. 29–35 are views similar to FIGS. 1–7, respectively, but showing a fifth embodiment thereof; and,

Westlock National Brochure; inside right page; lever (upper right), Aug. 15, 1995.

FIGS. 36–42 are views similar to FIGS. 1–7, respectively, but showing a sixth embodiment thereof.

Schlage—Residential Catalog; p. 23; Saturn lever Aug. 15, 1995.

1 Claim, 42 Drawing Sheets

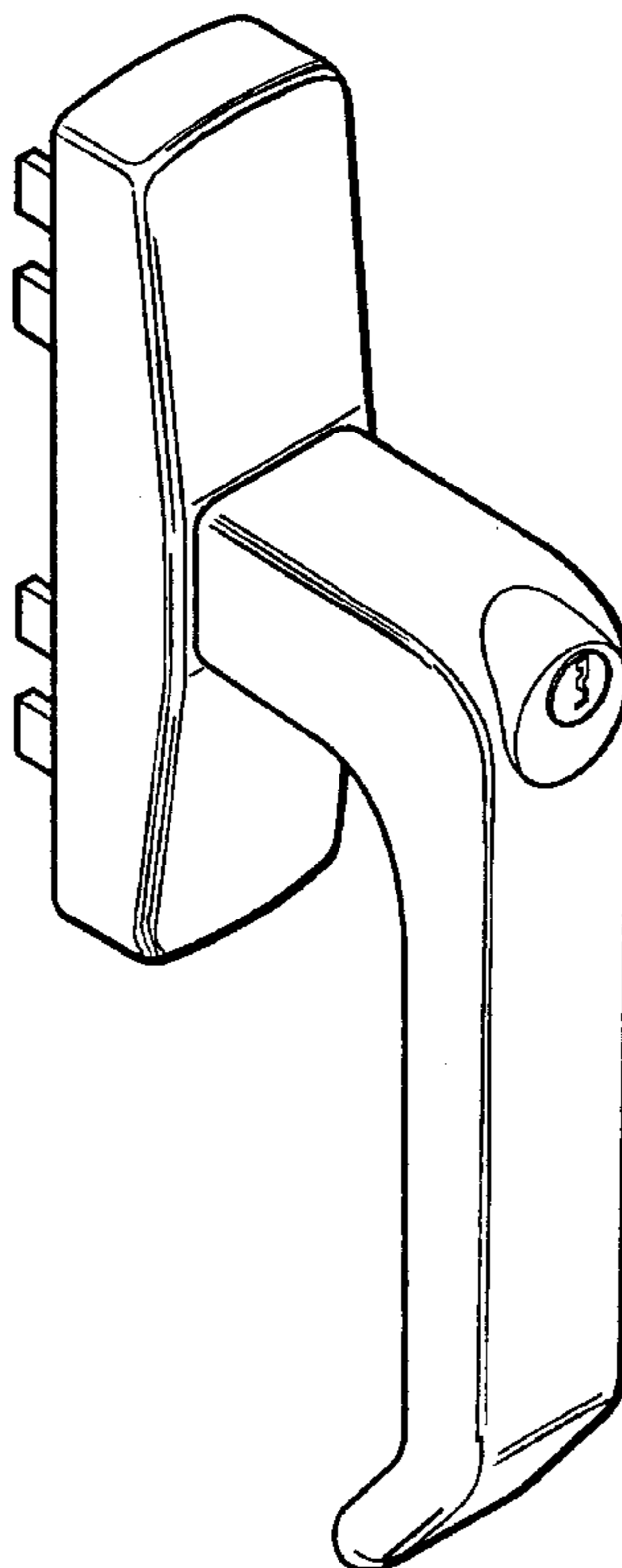

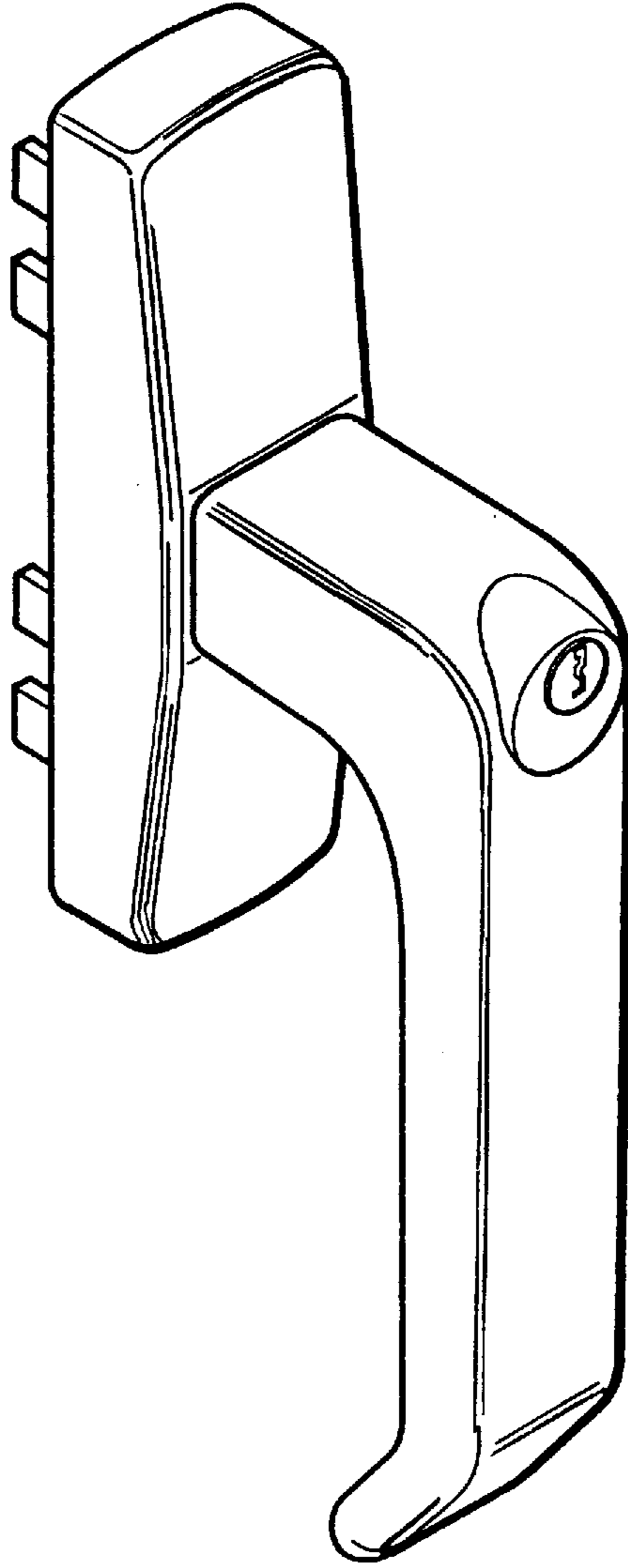

Fig. 1

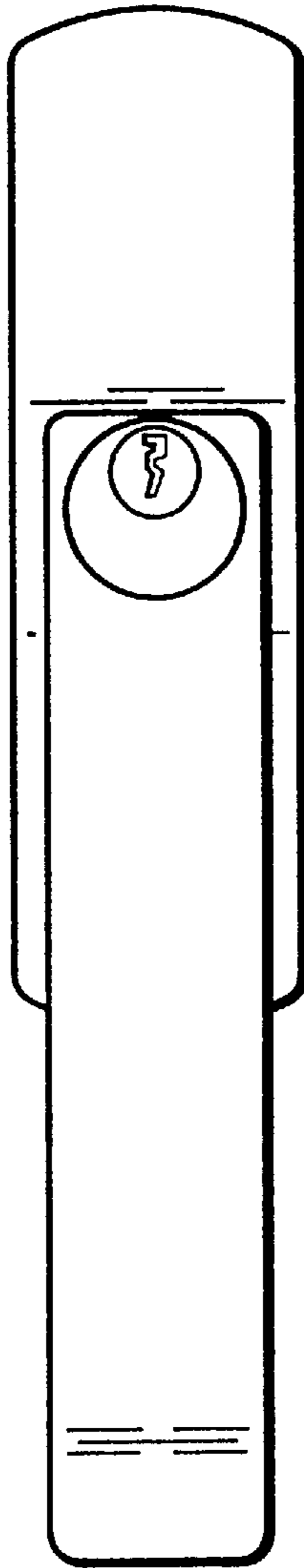

Fig. 2

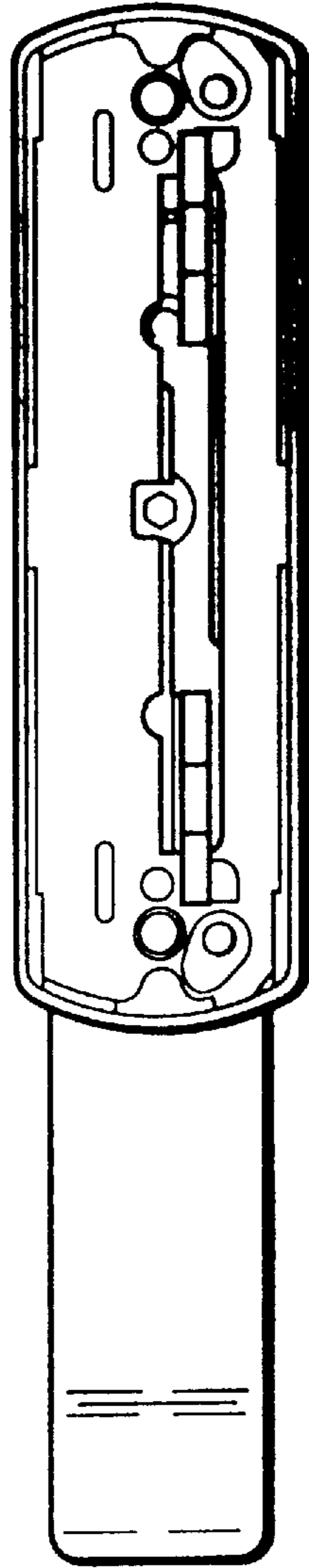

Fig. 3

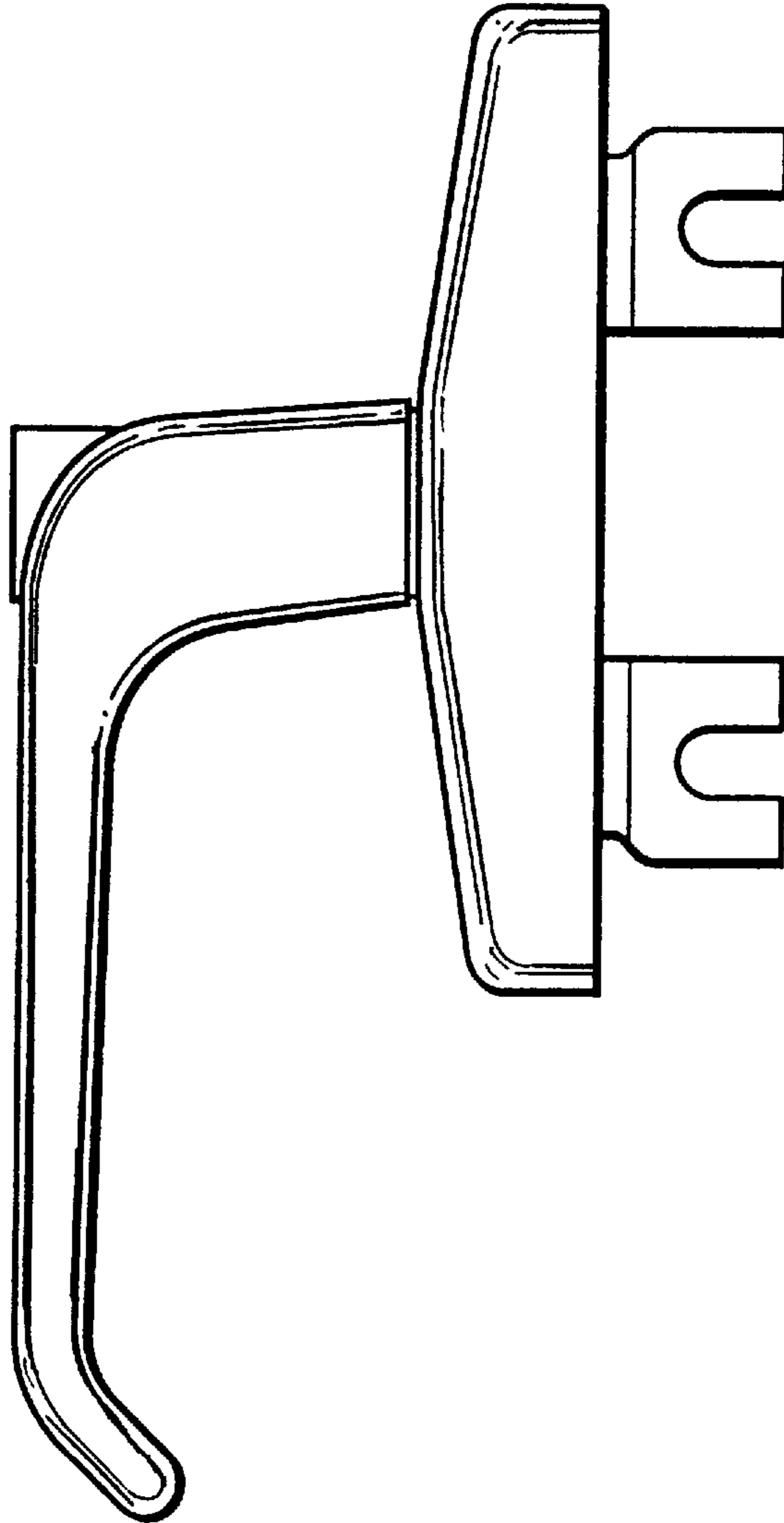

Fig. 4

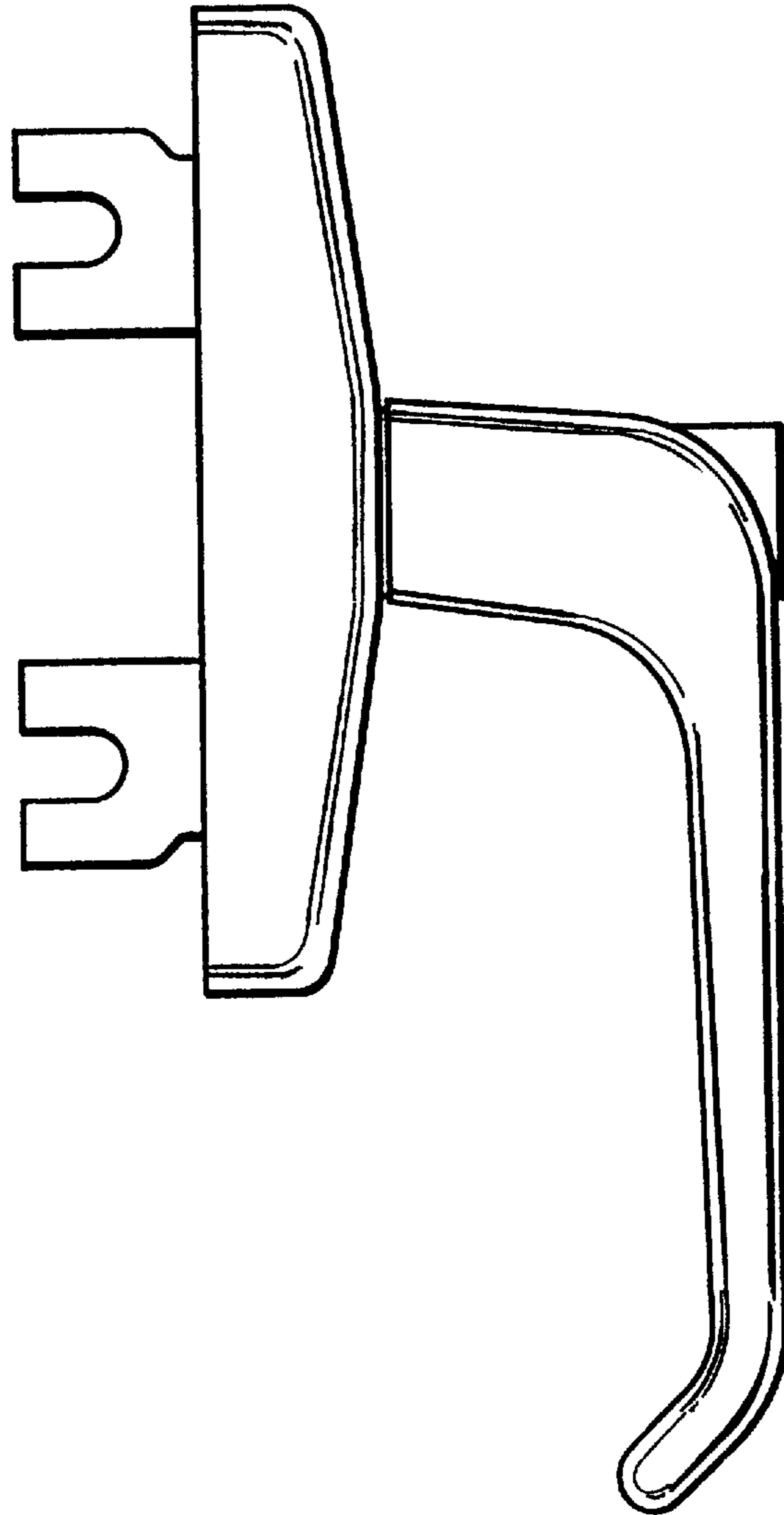

Fig. 5

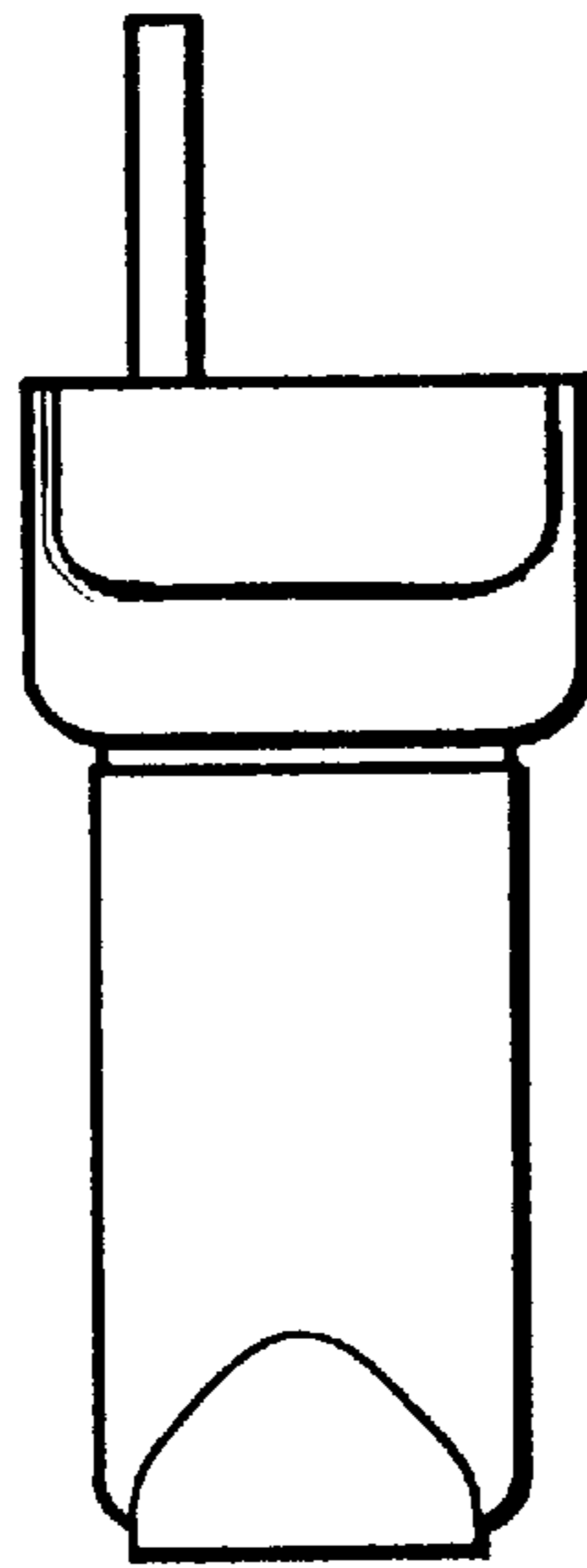

Fig. 6

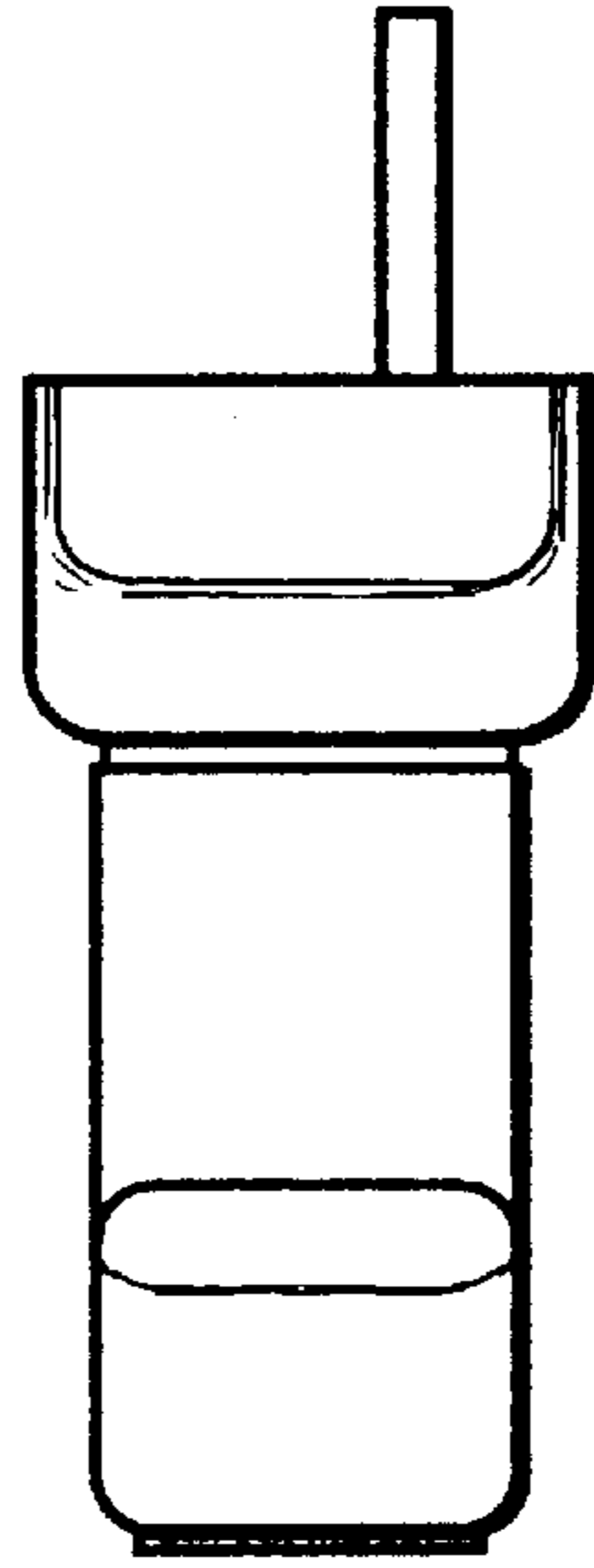

Fig. 7

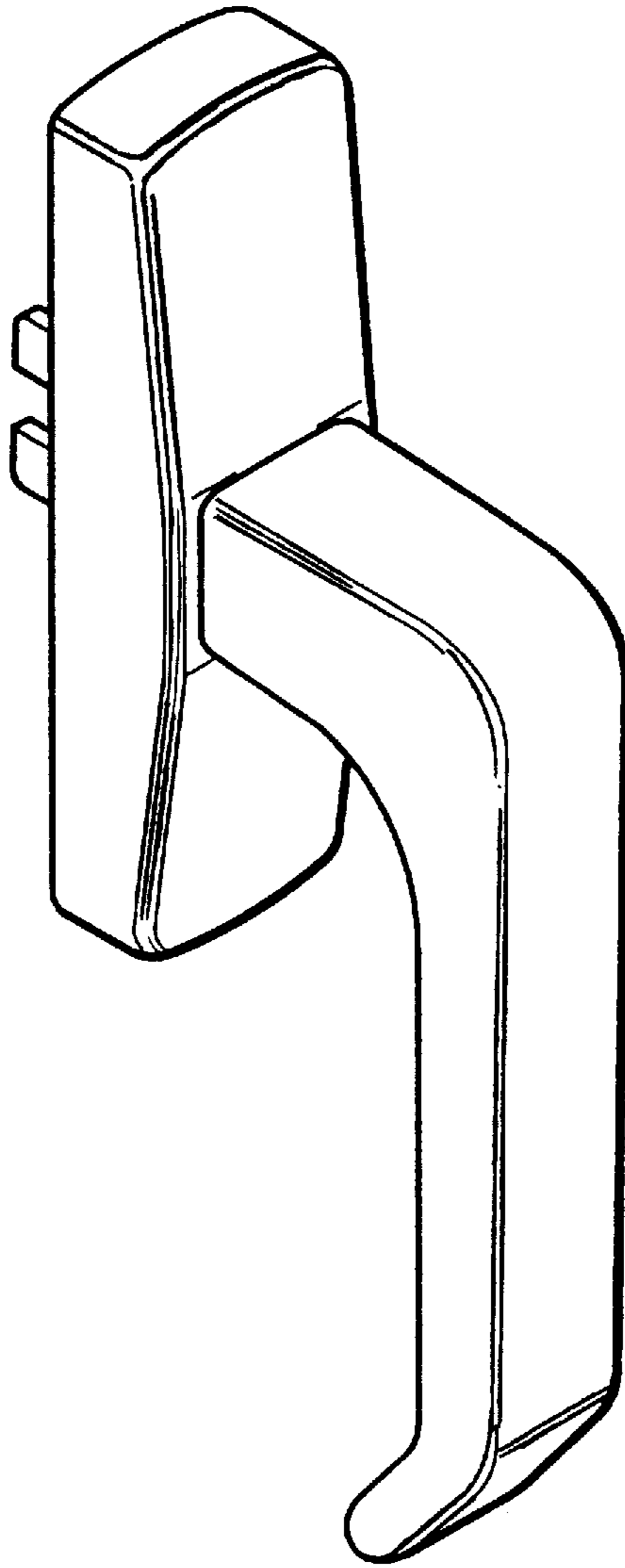

Fig. 8

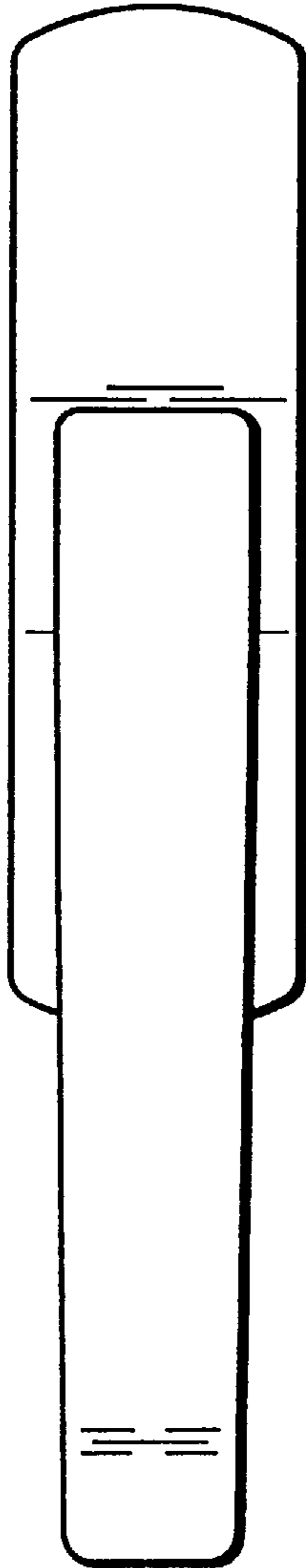

Fig. 9

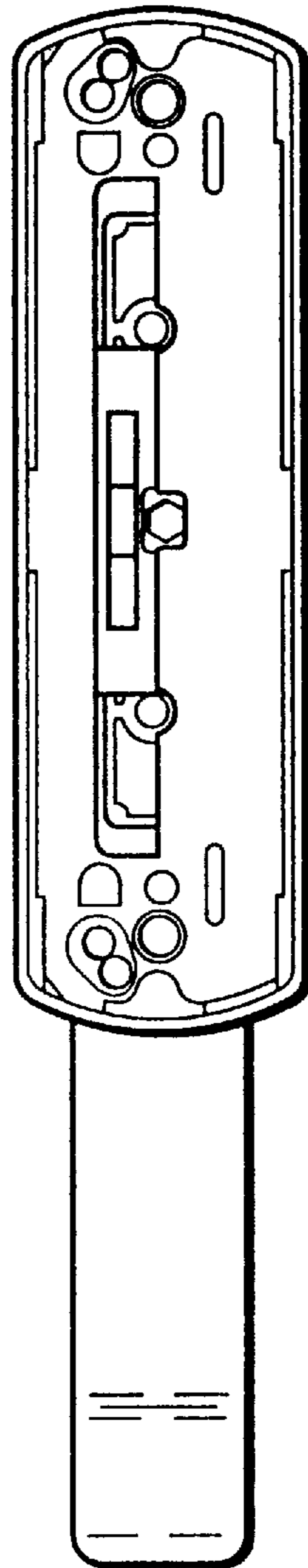

Fig. 10

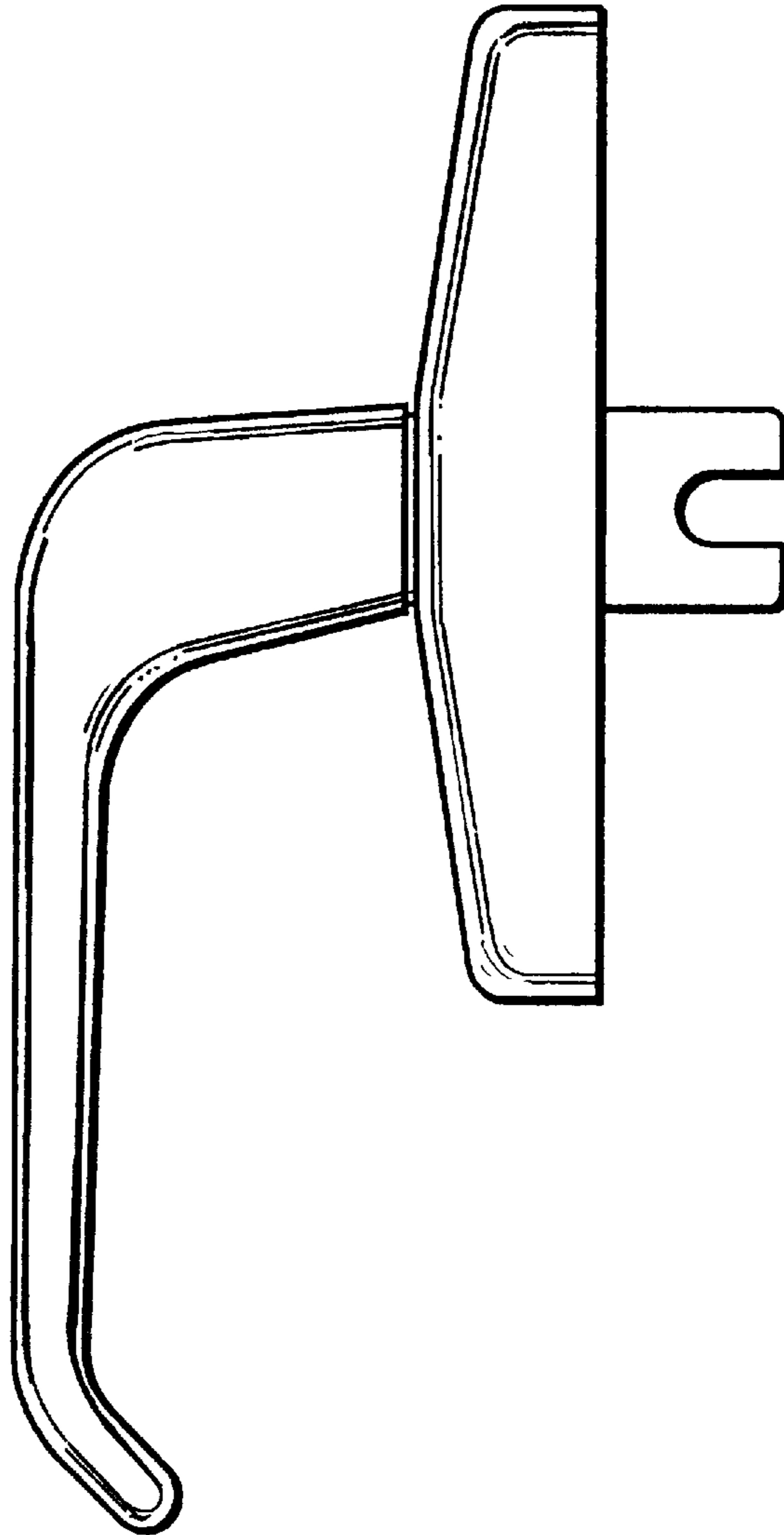

Fig. 11

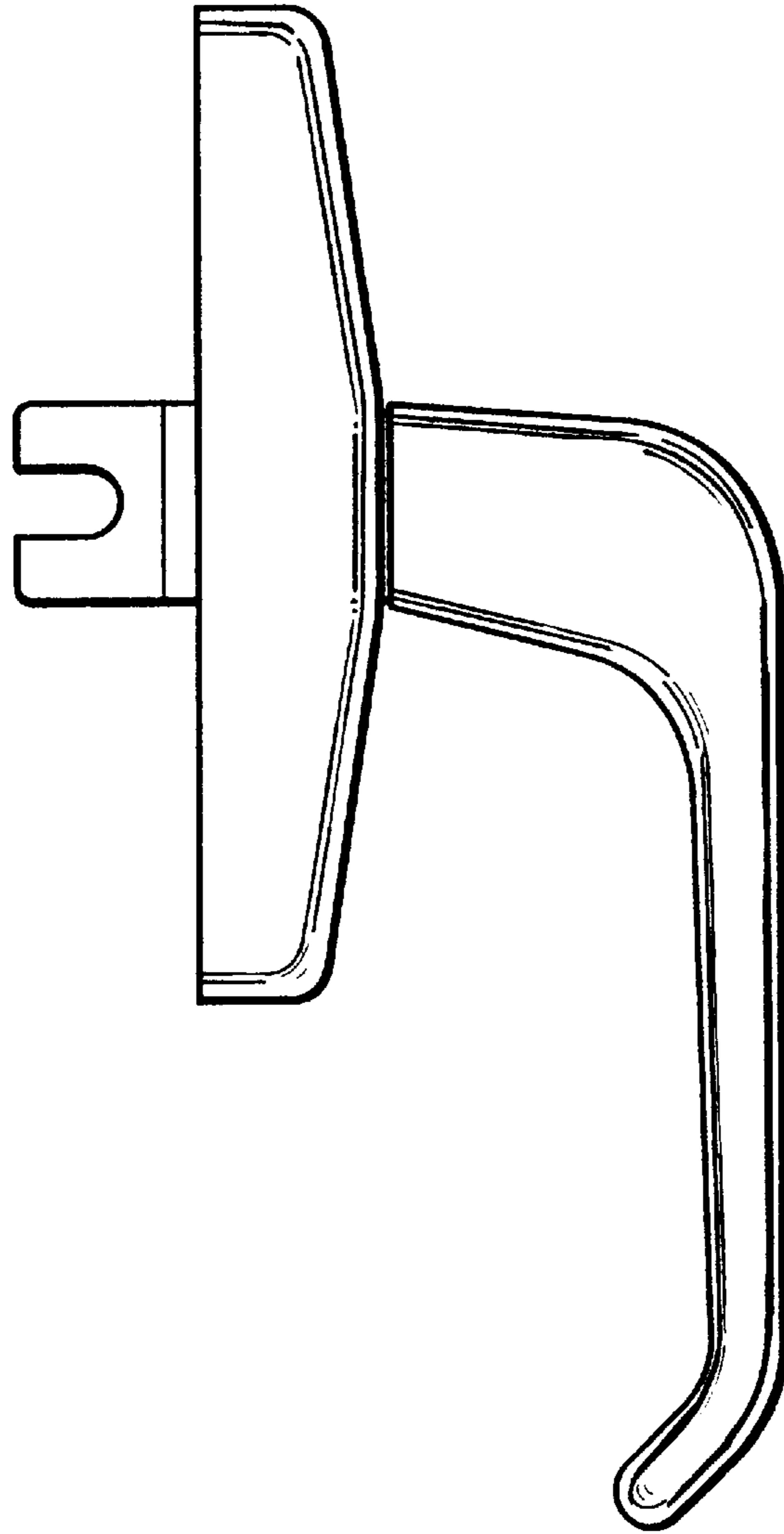

Fig. 12

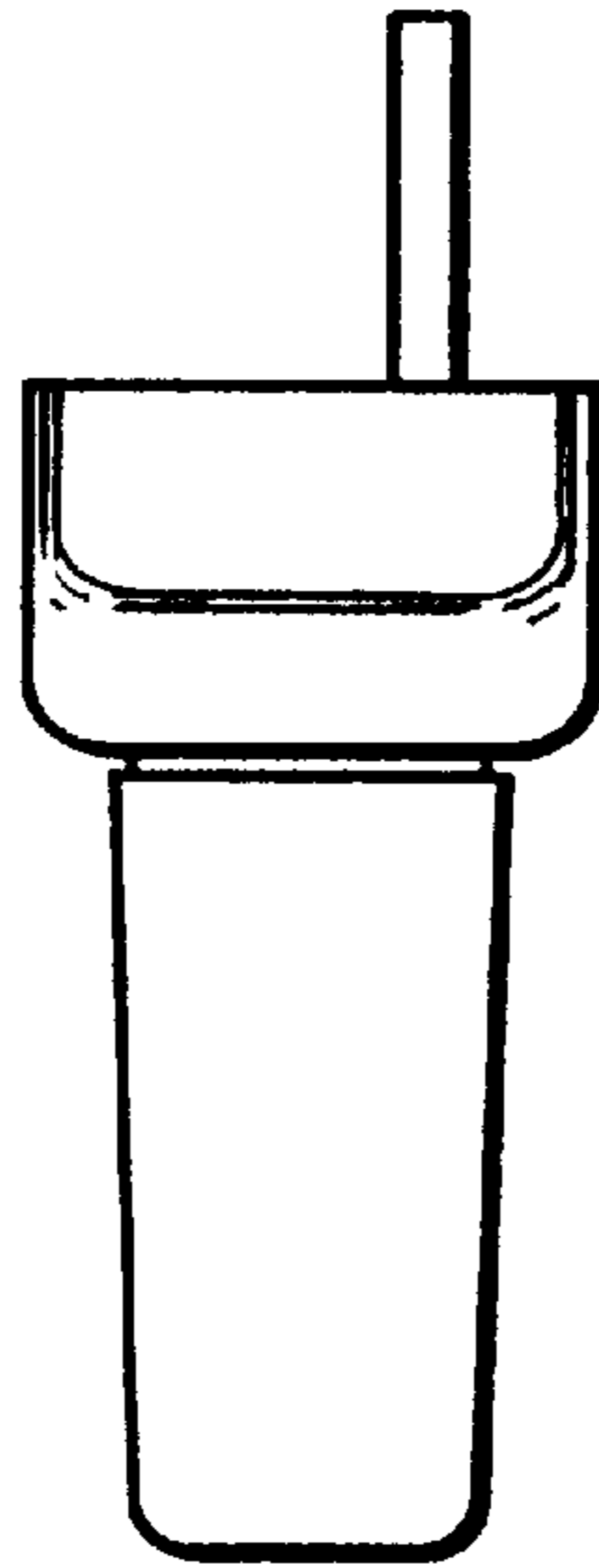

Fig. 13

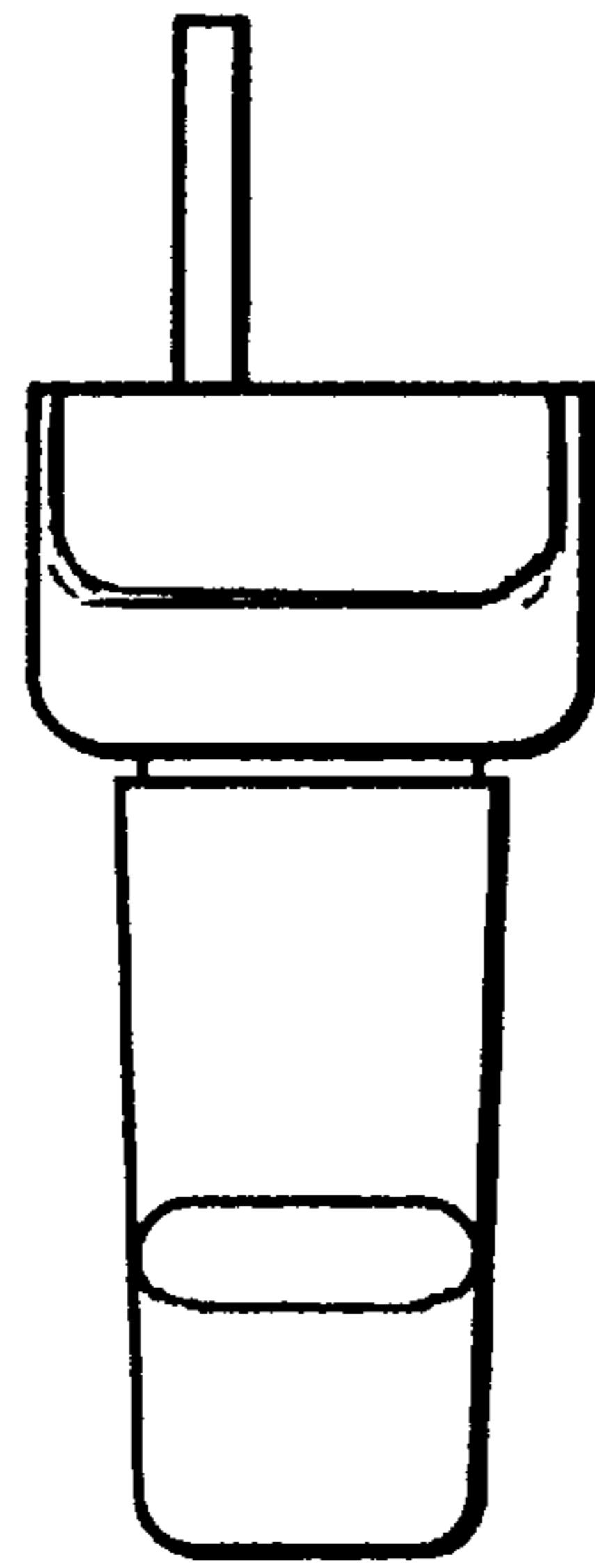

Fig. 14

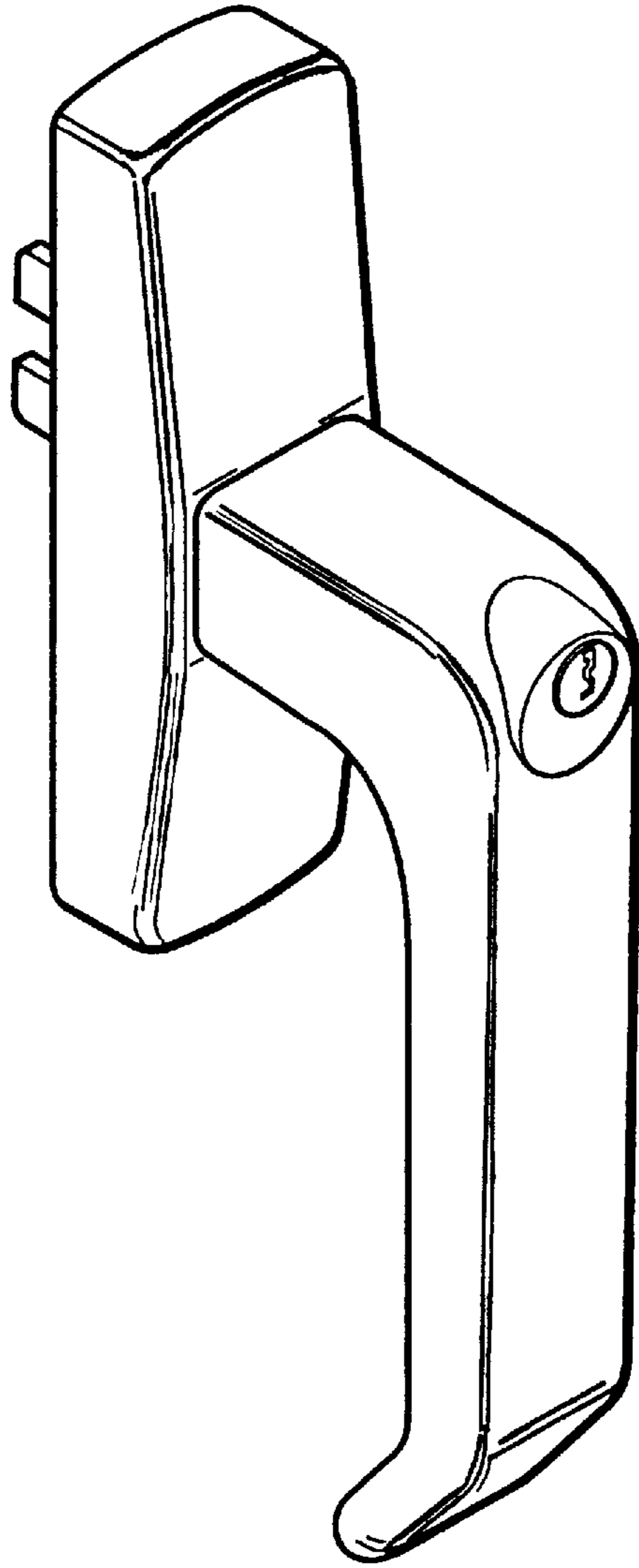

Fig. 15

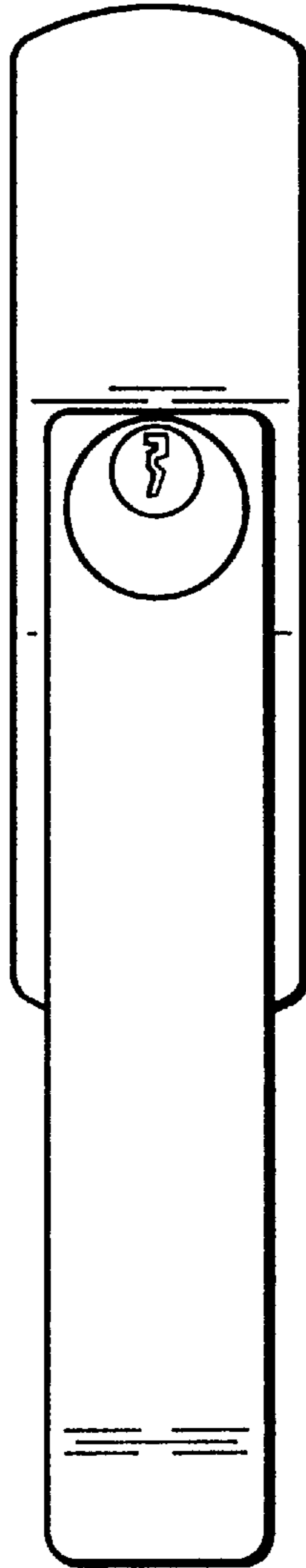

Fig. 16

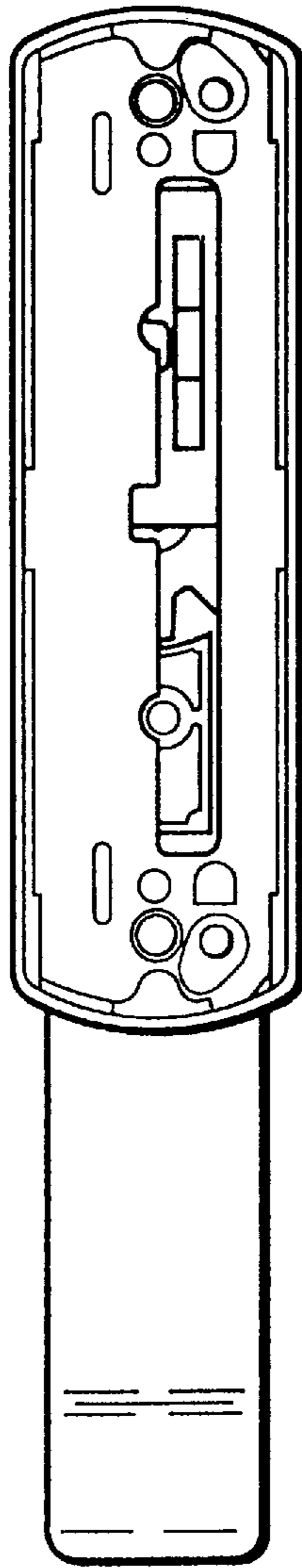

Fig. 17

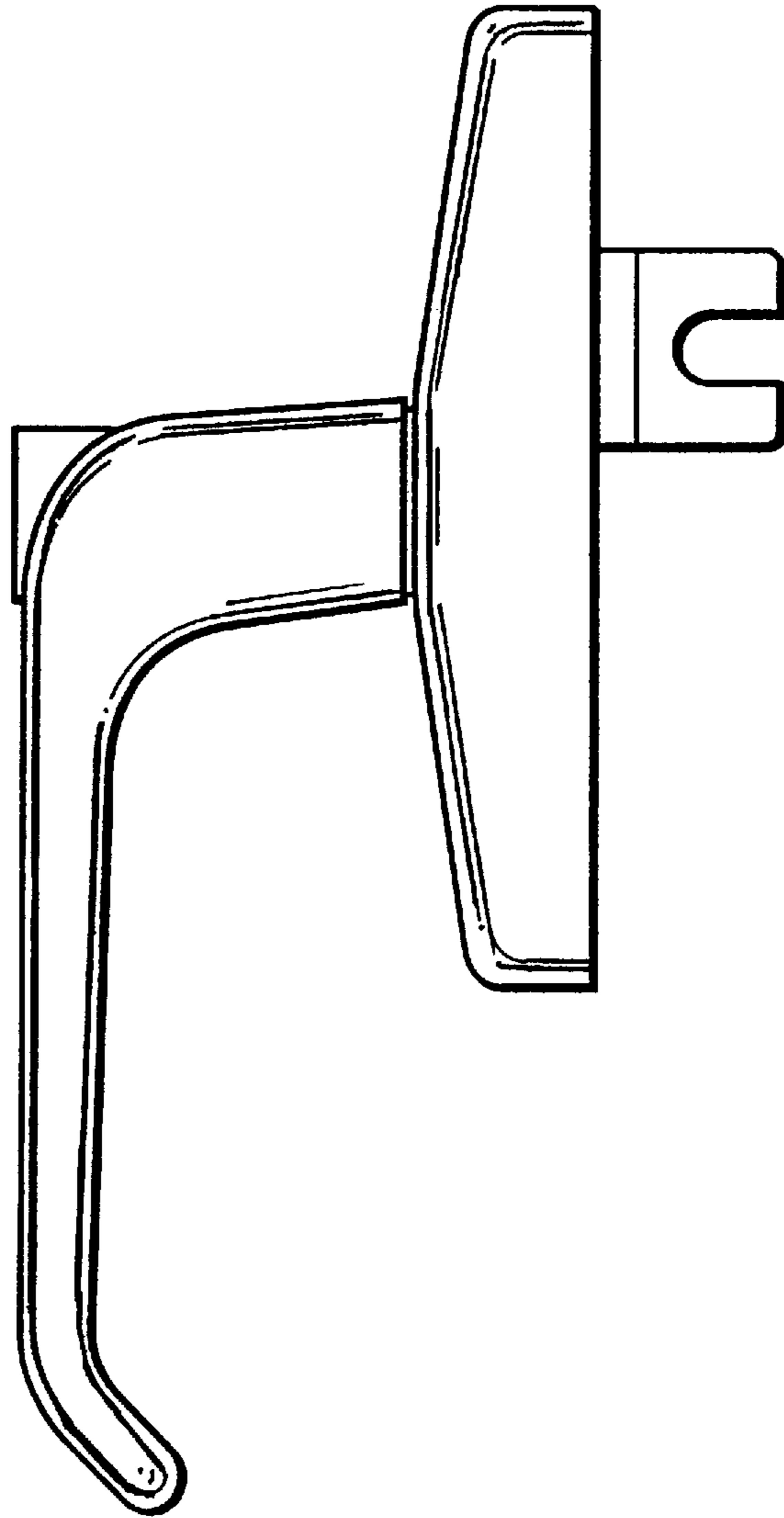

Fig. 18

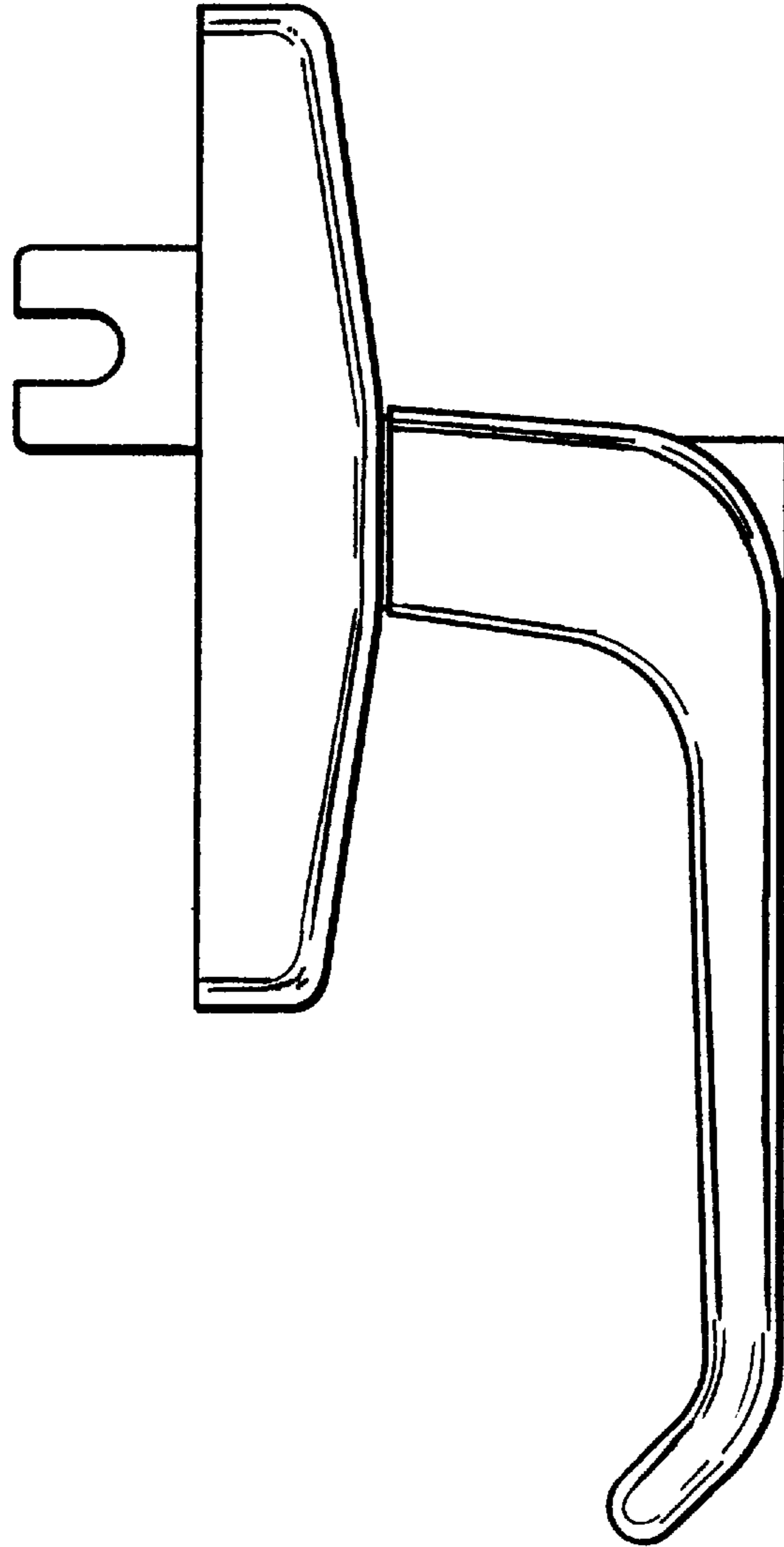

Fig. 19

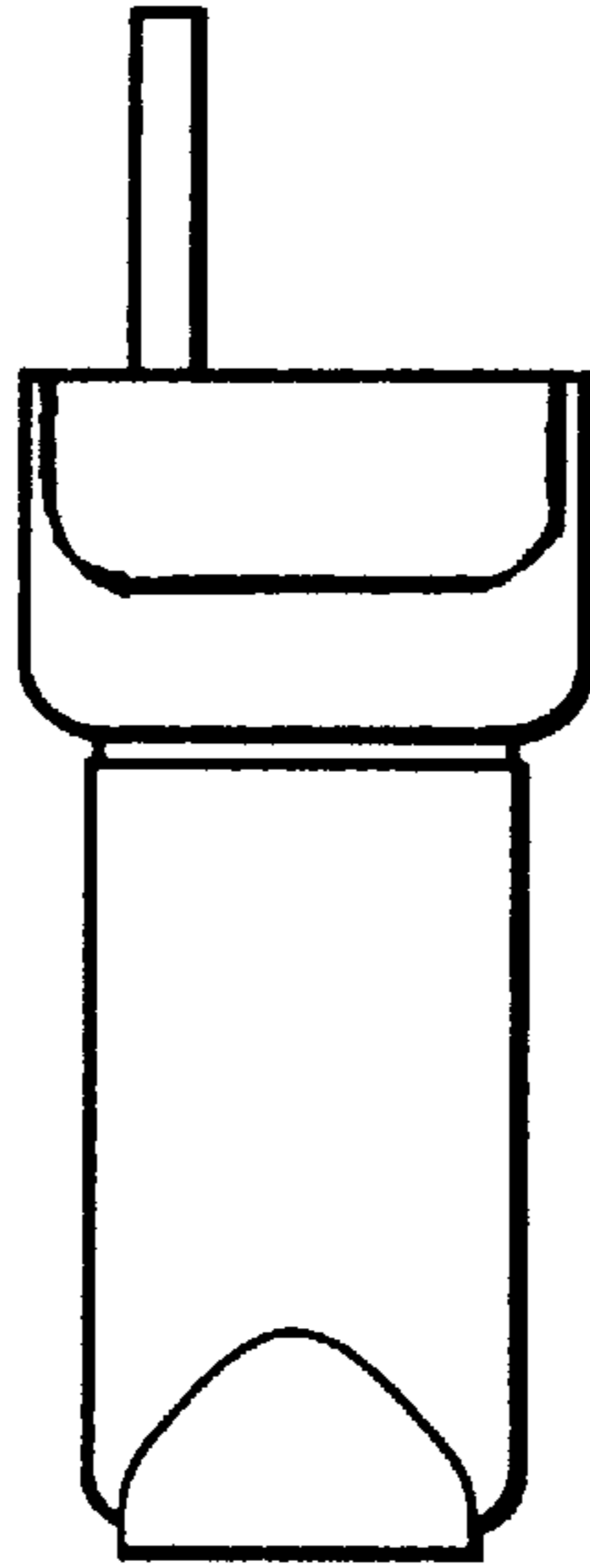

Fig. 20

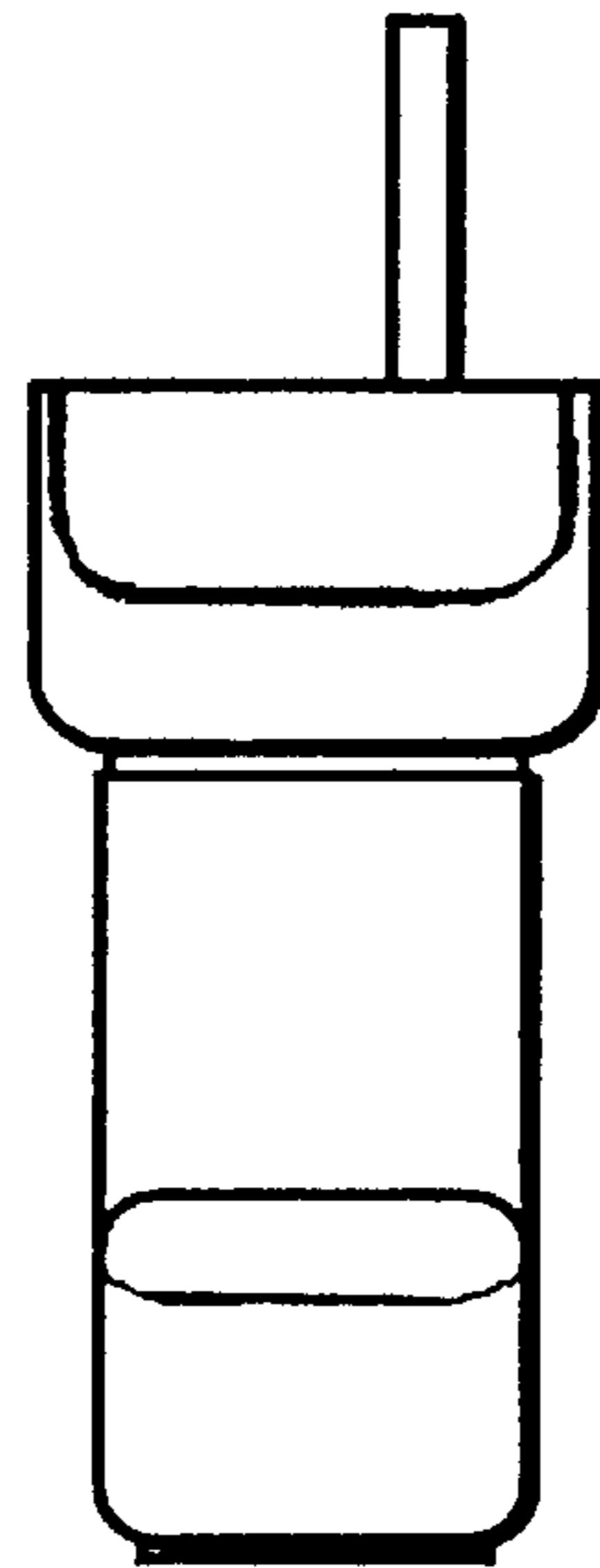

Fig. 21

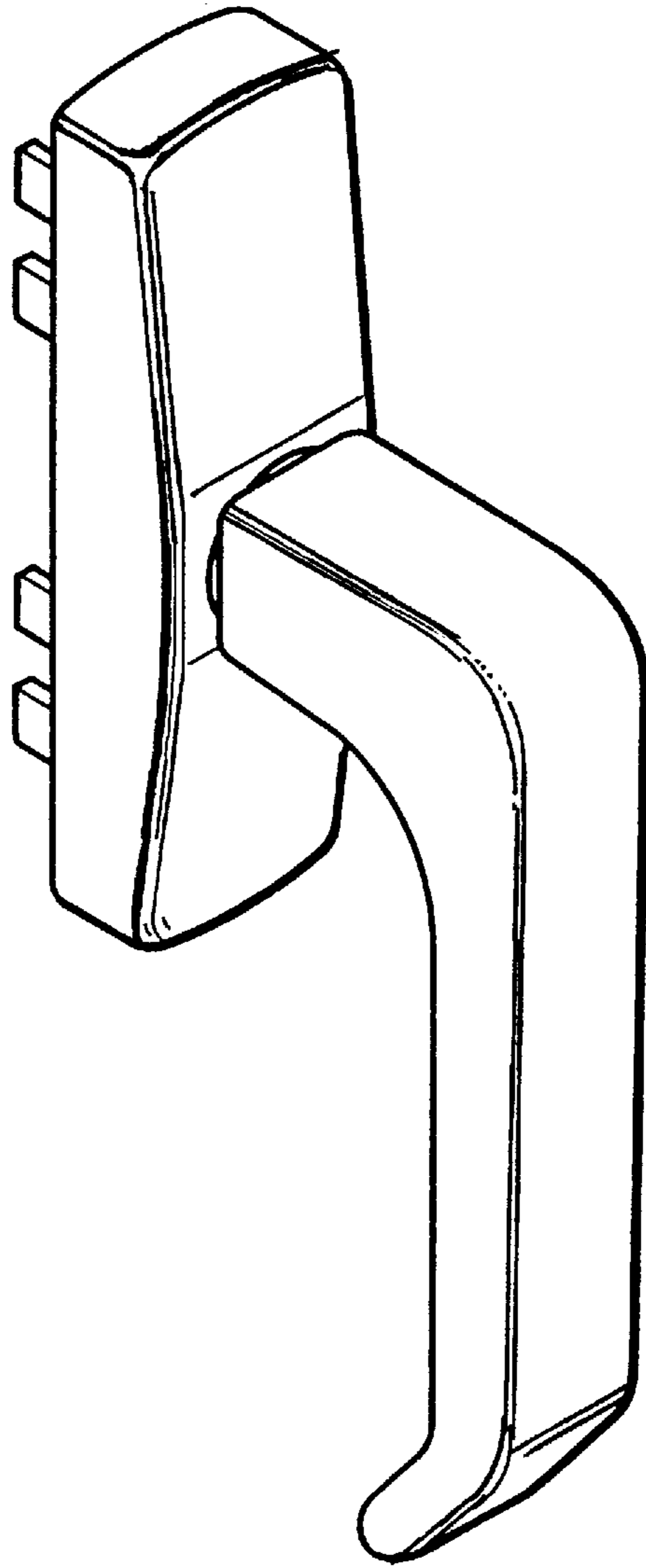

Fig. 22

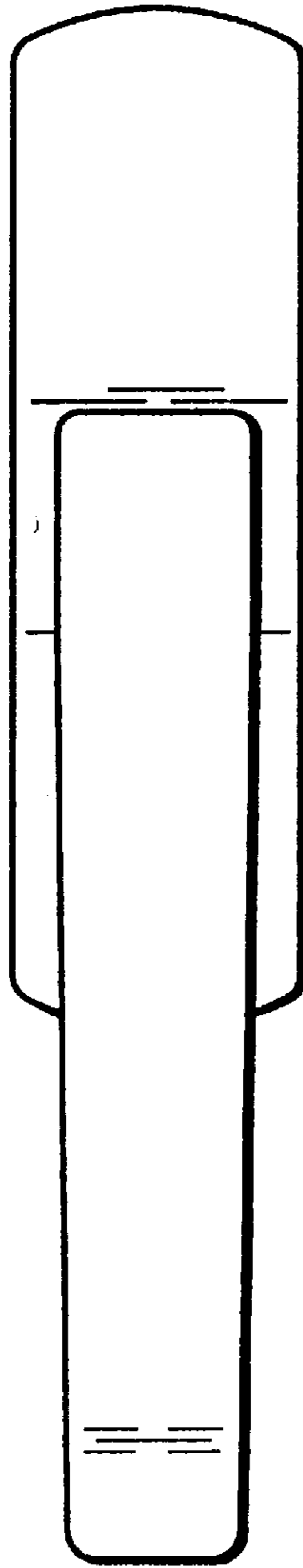

Fig. 23

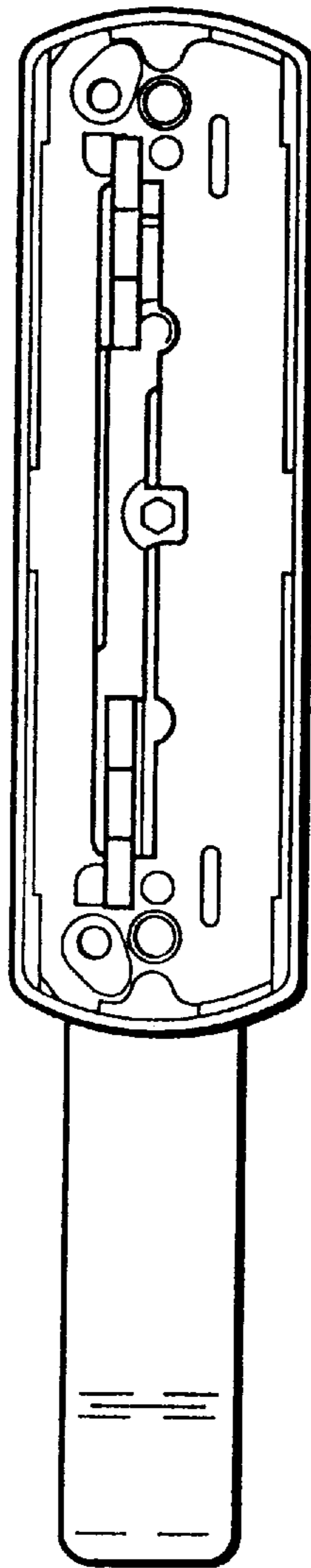

Fig. 24

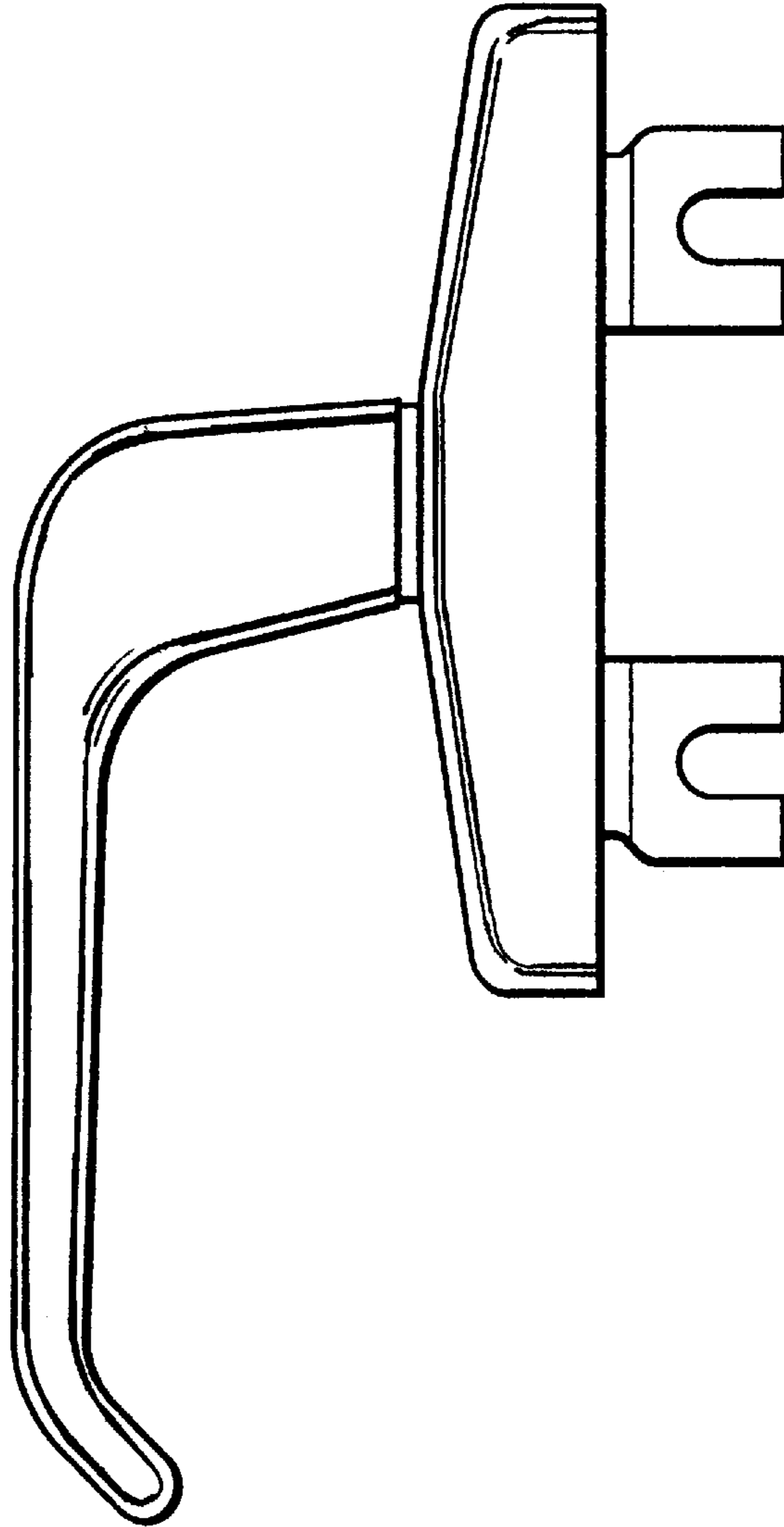

Fig. 25

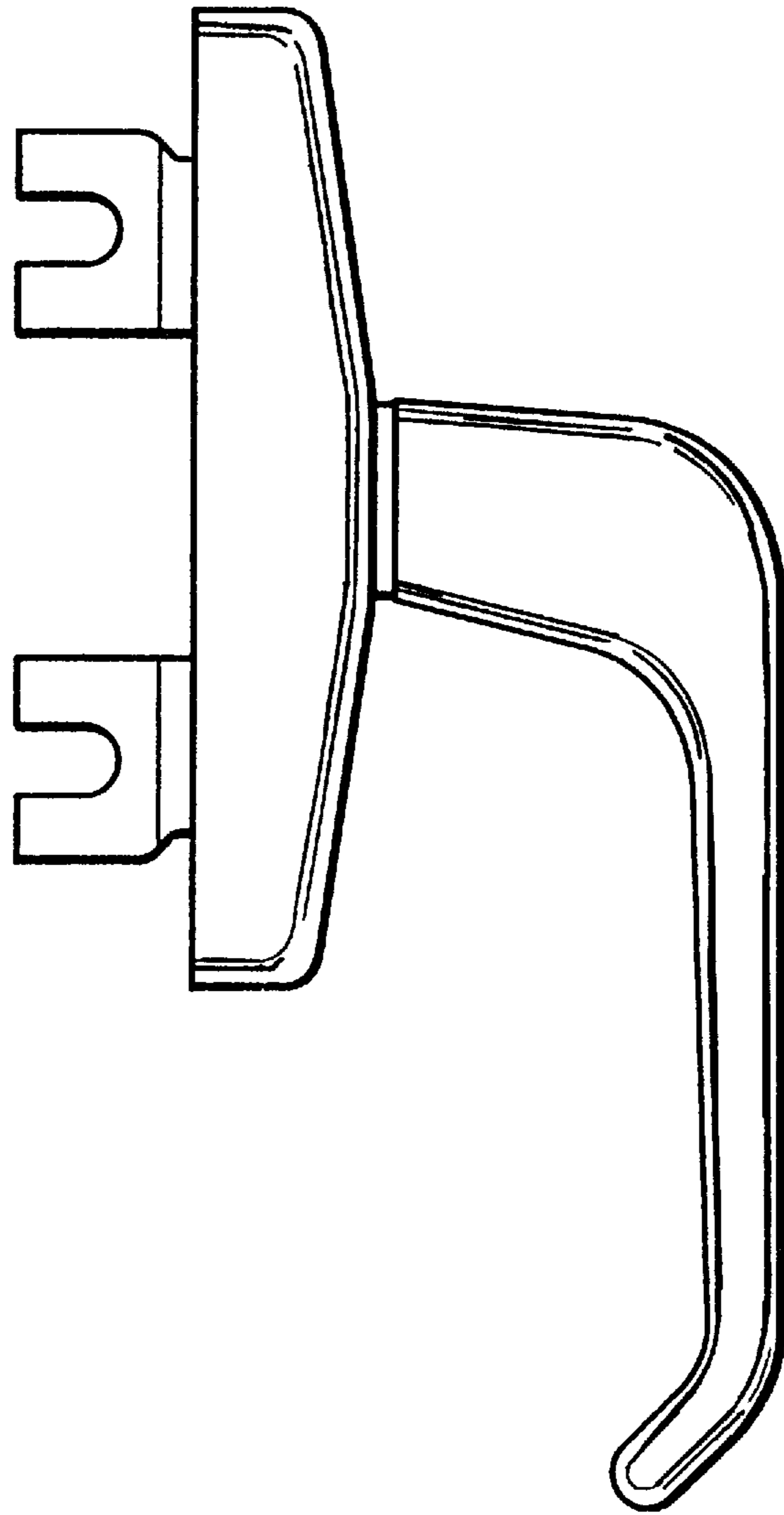

Fig. 26

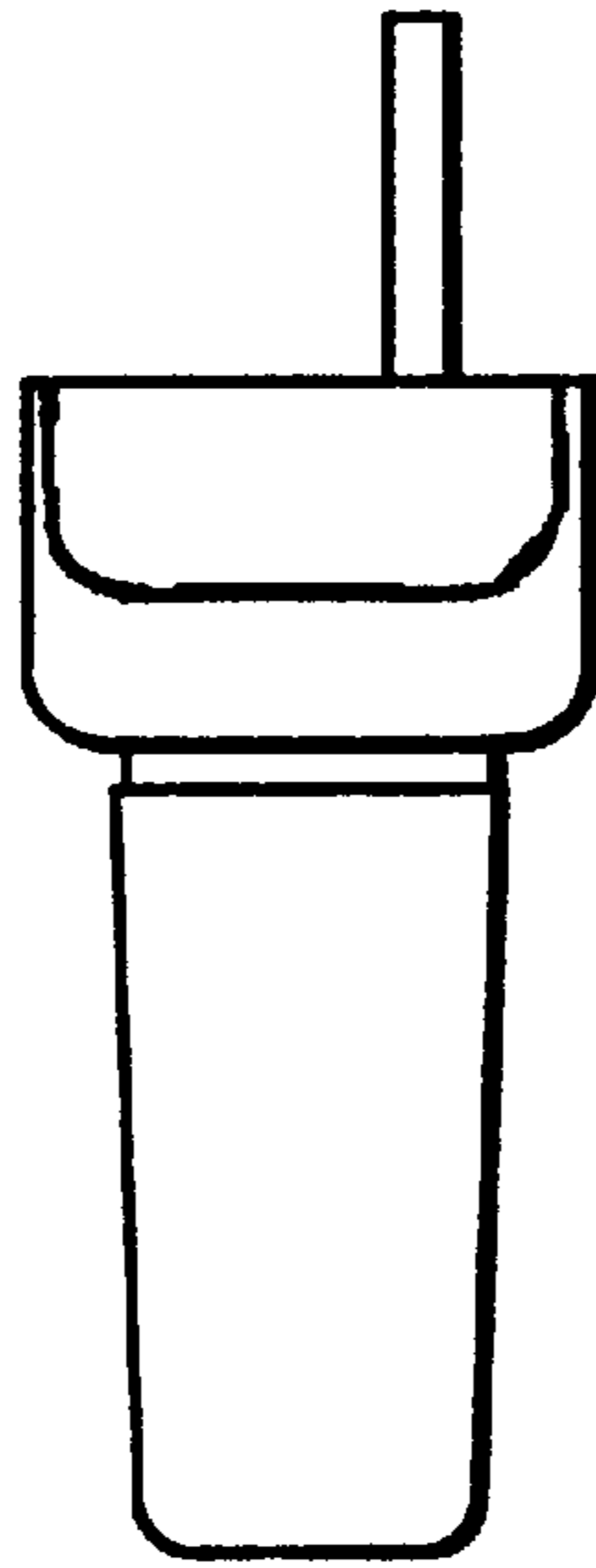

Fig. 27

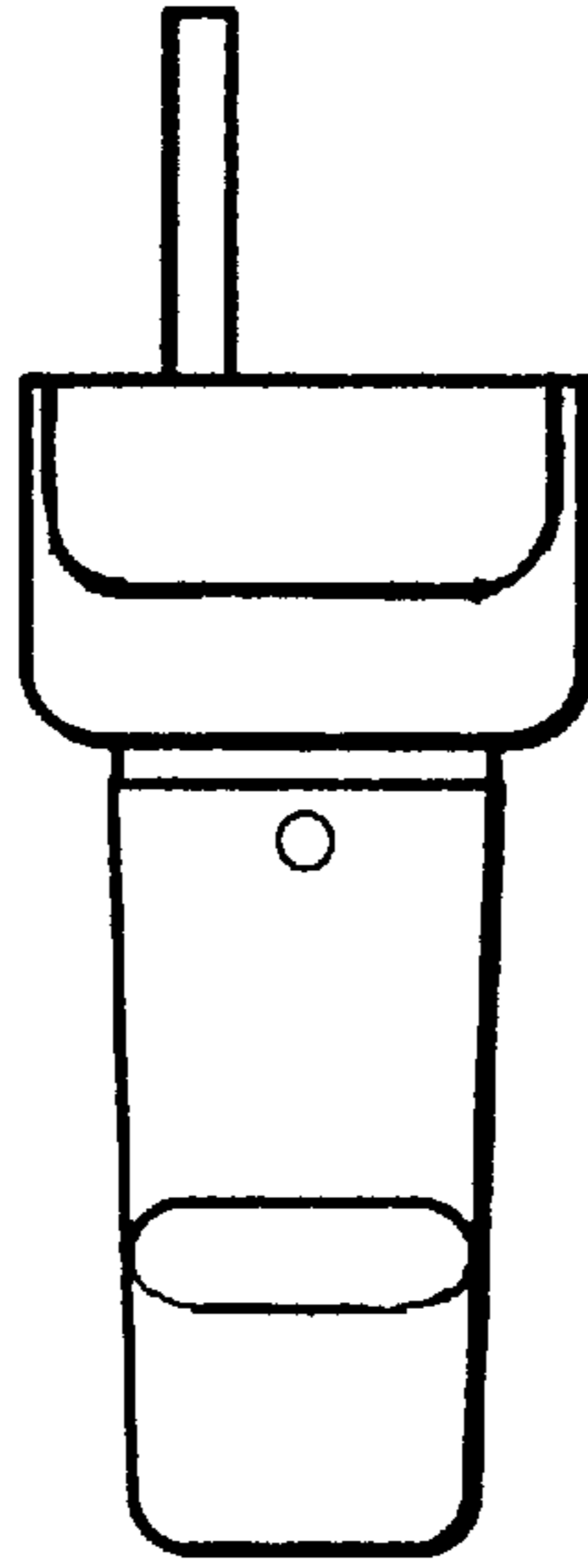

Fig. 28

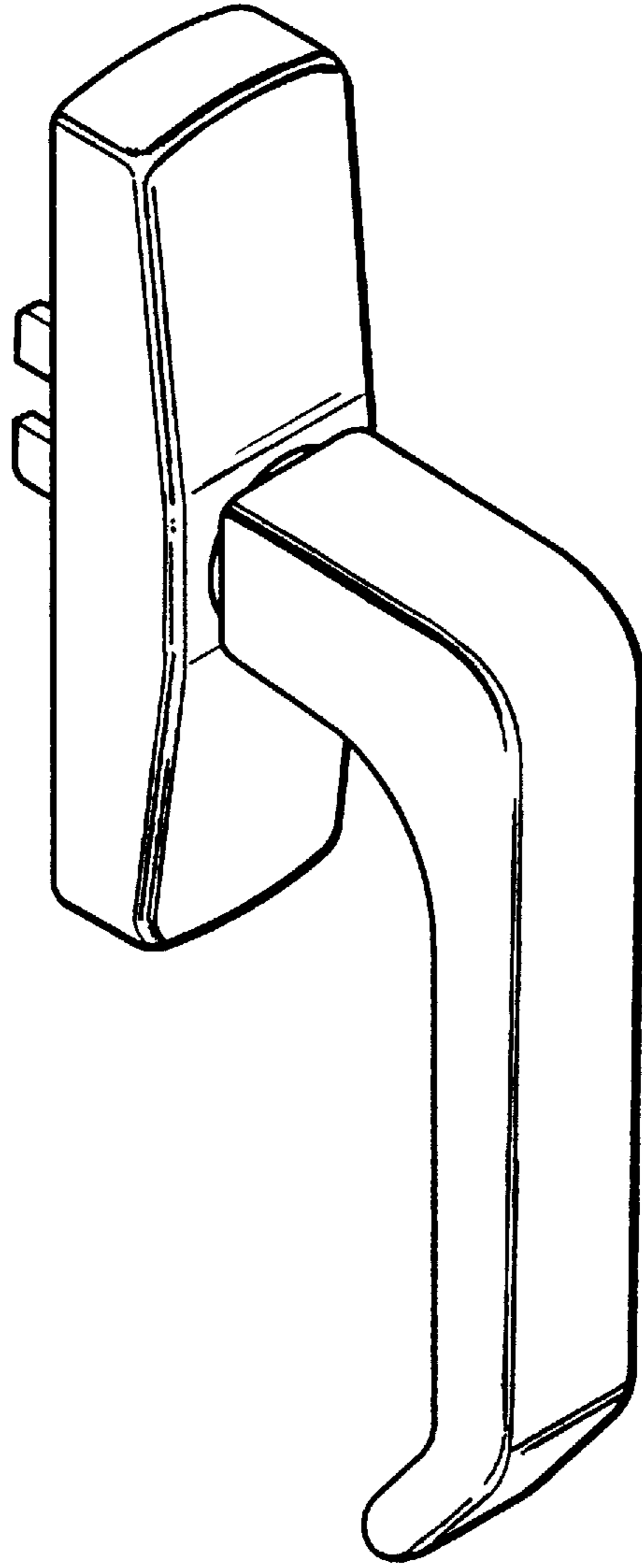

Fig. 29

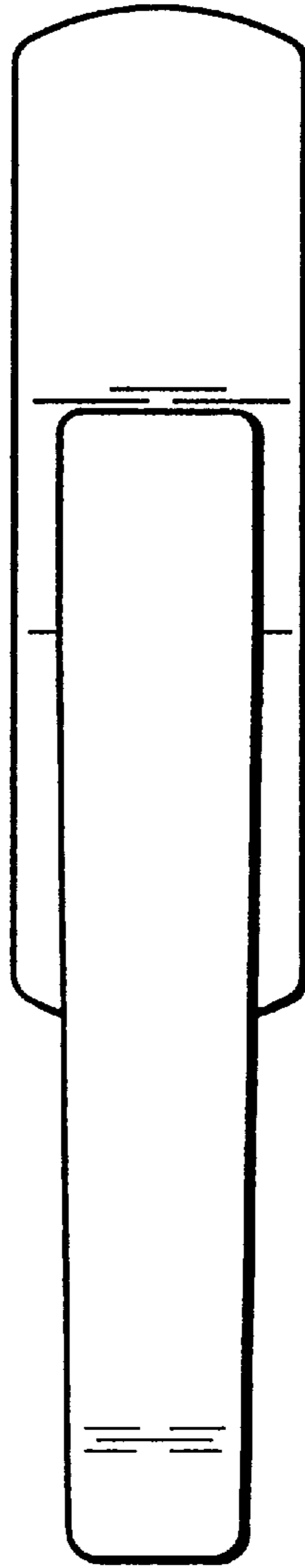

Fig. 30

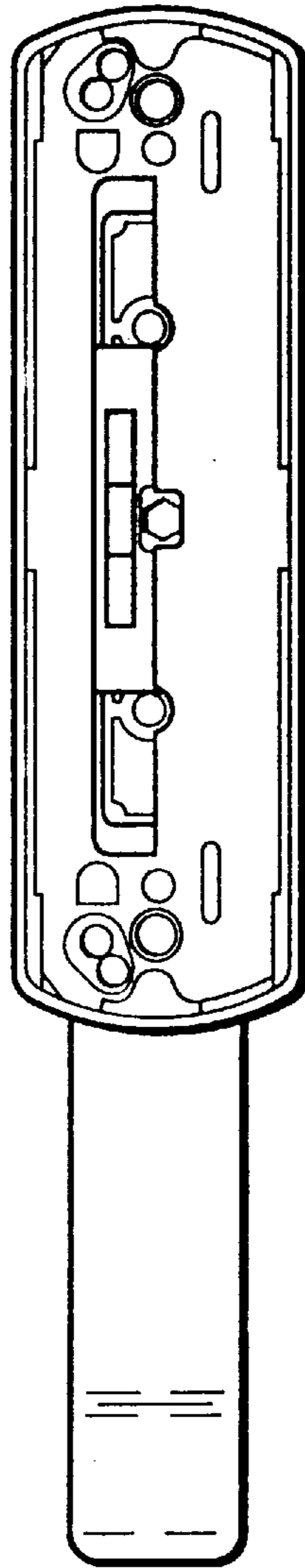

Fig. 31

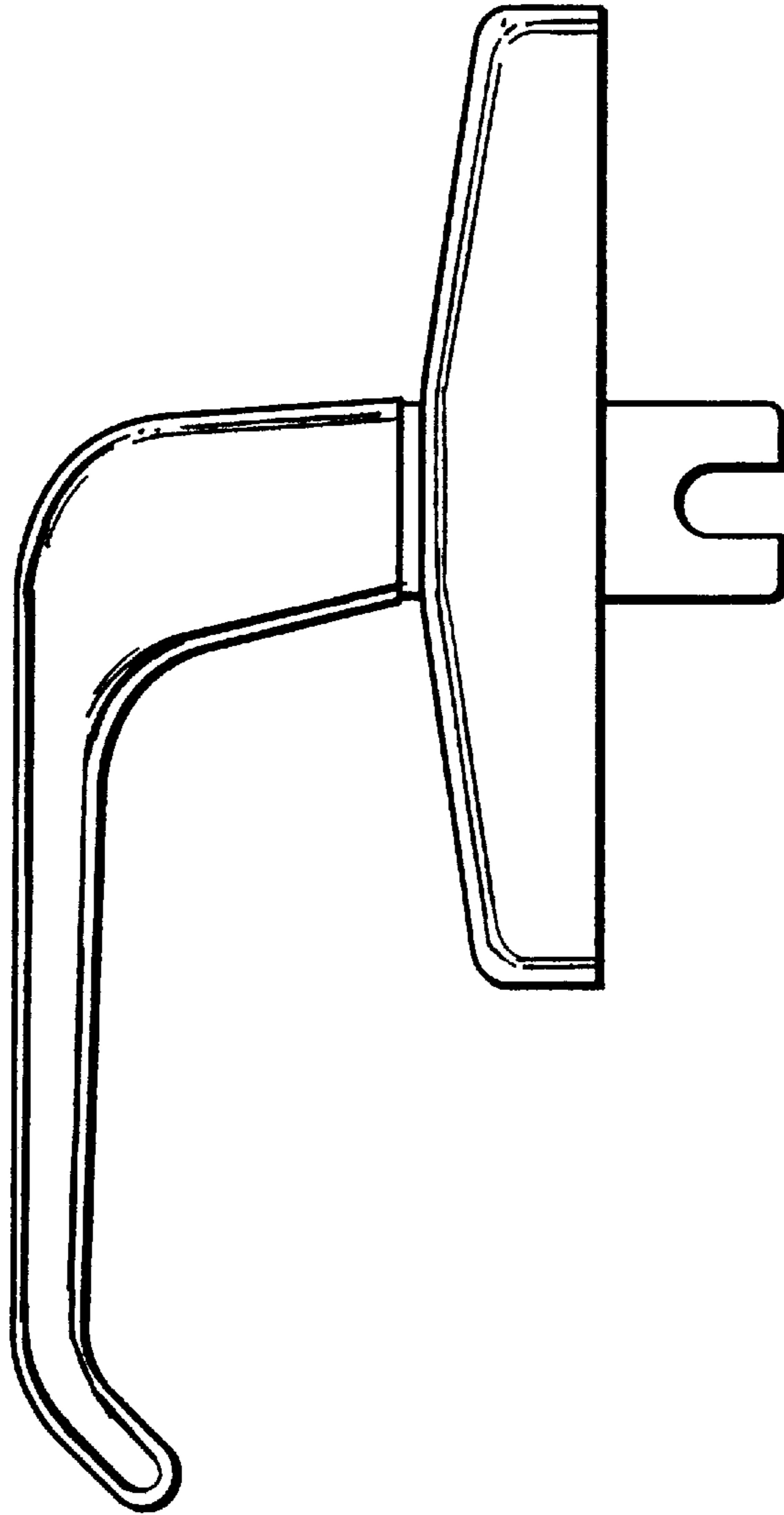

Fig. 32

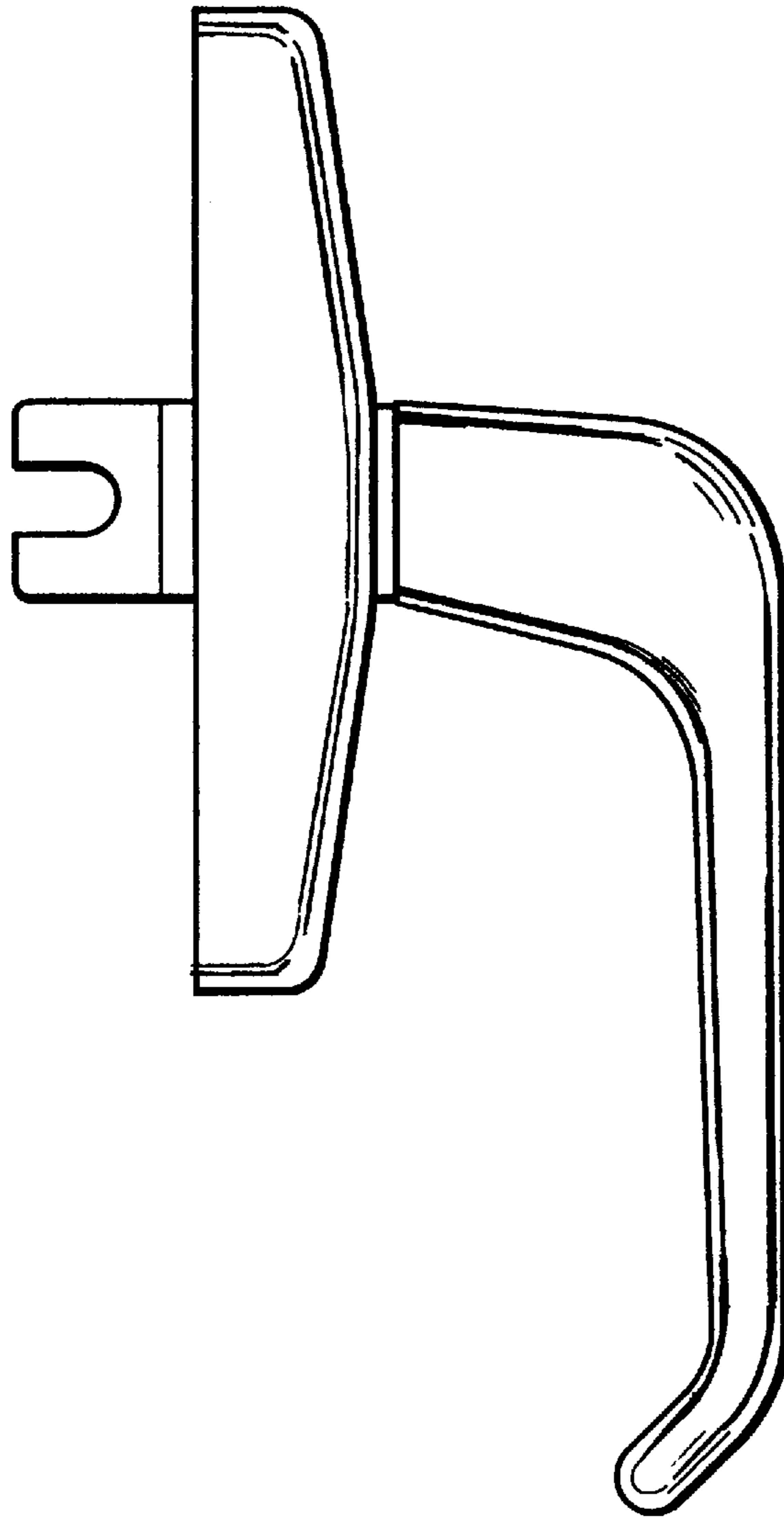

Fig. 33

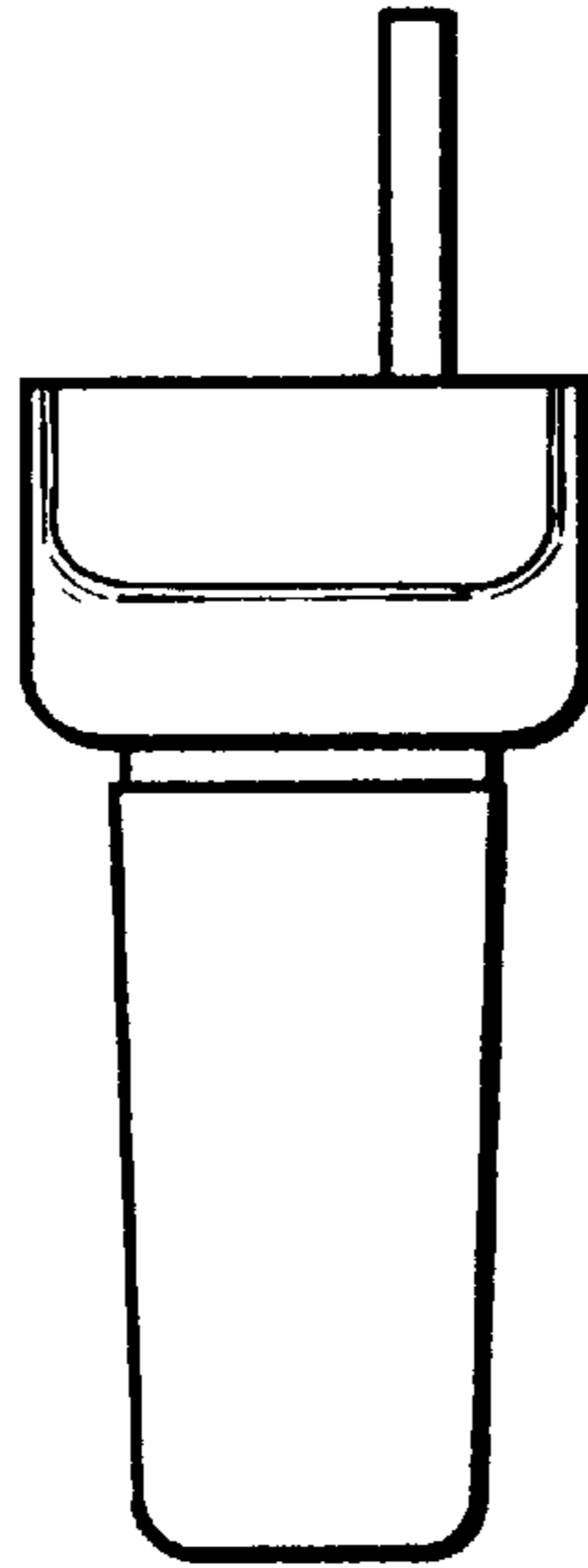

Fig. 34

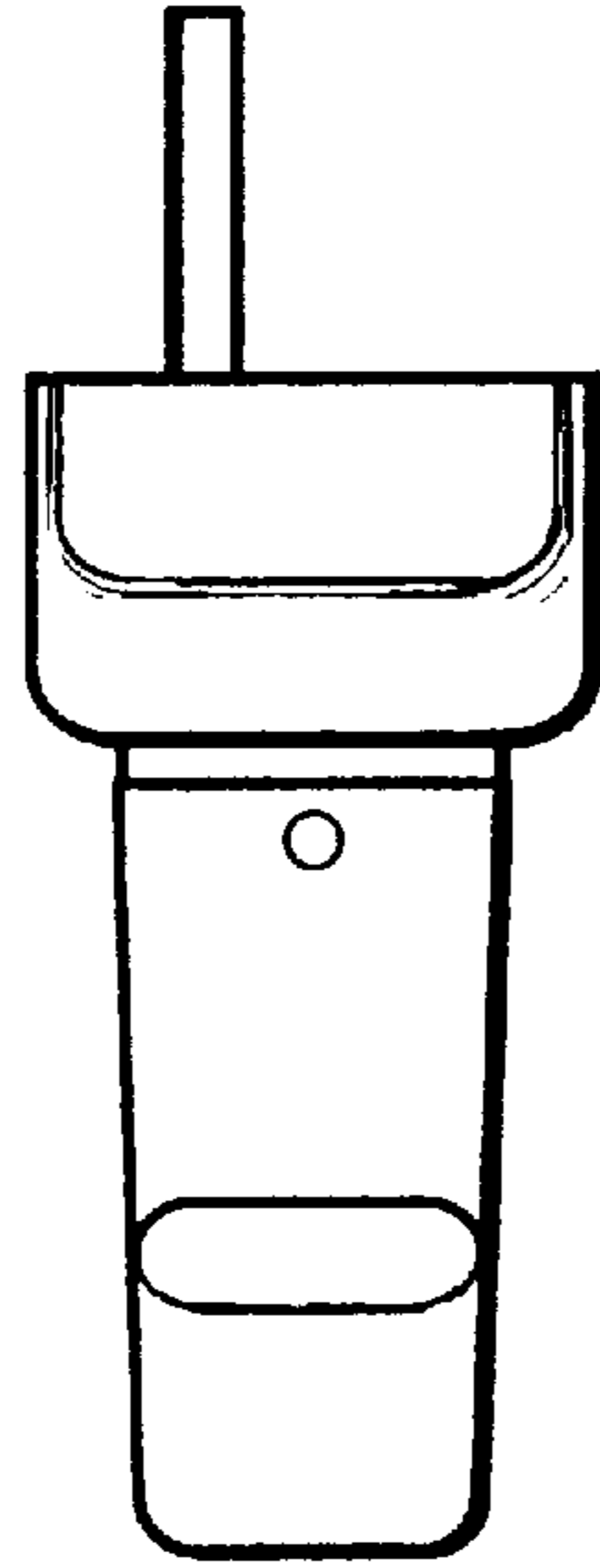

Fig. 35

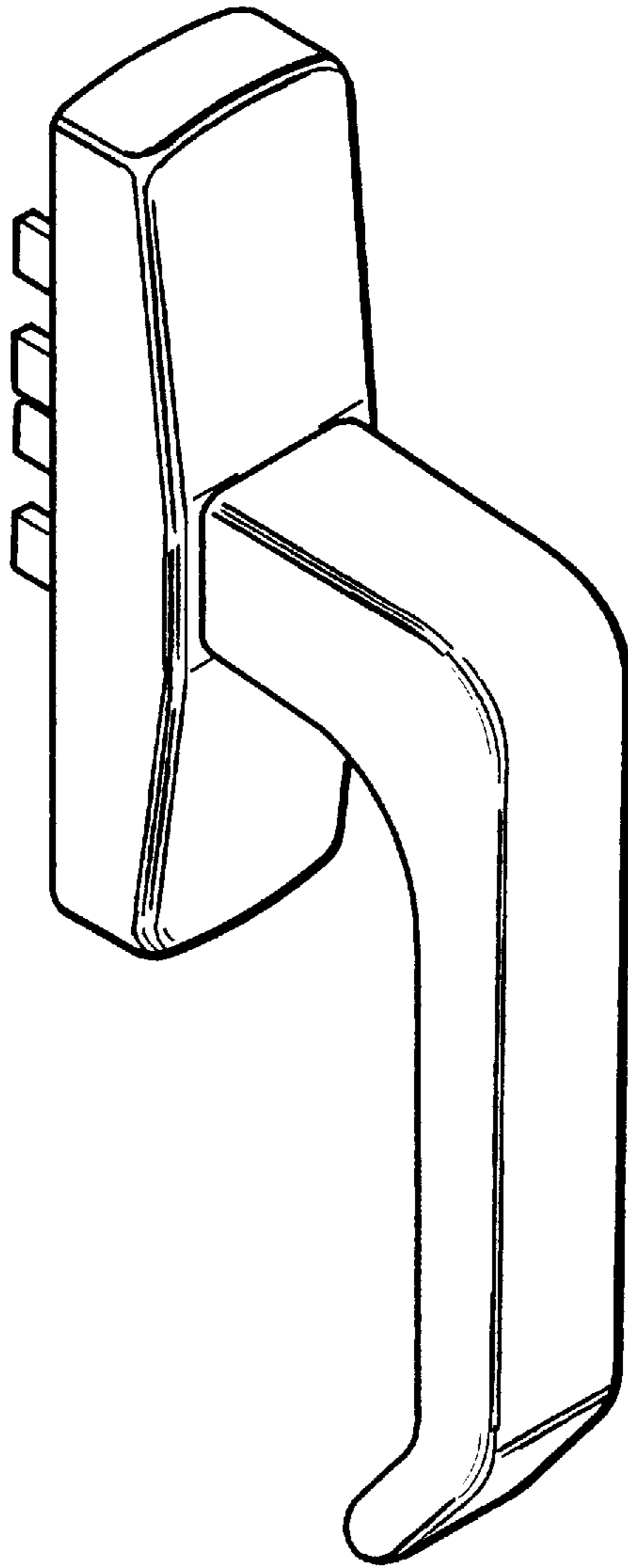

Fig. 36

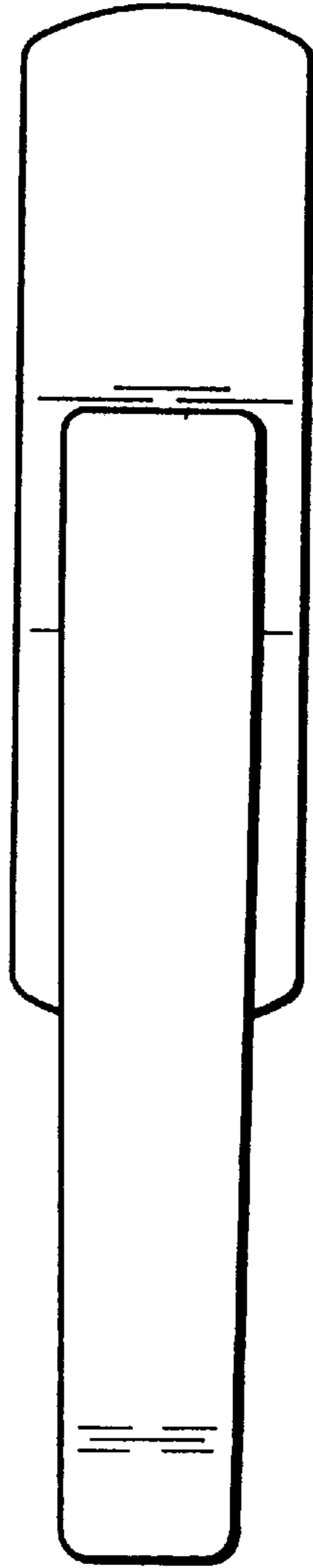

Fig. 37

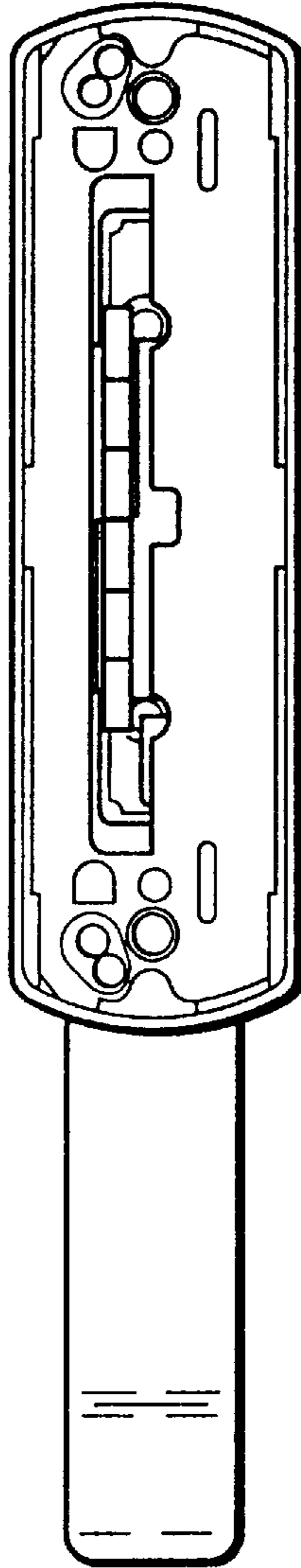

Fig. 38

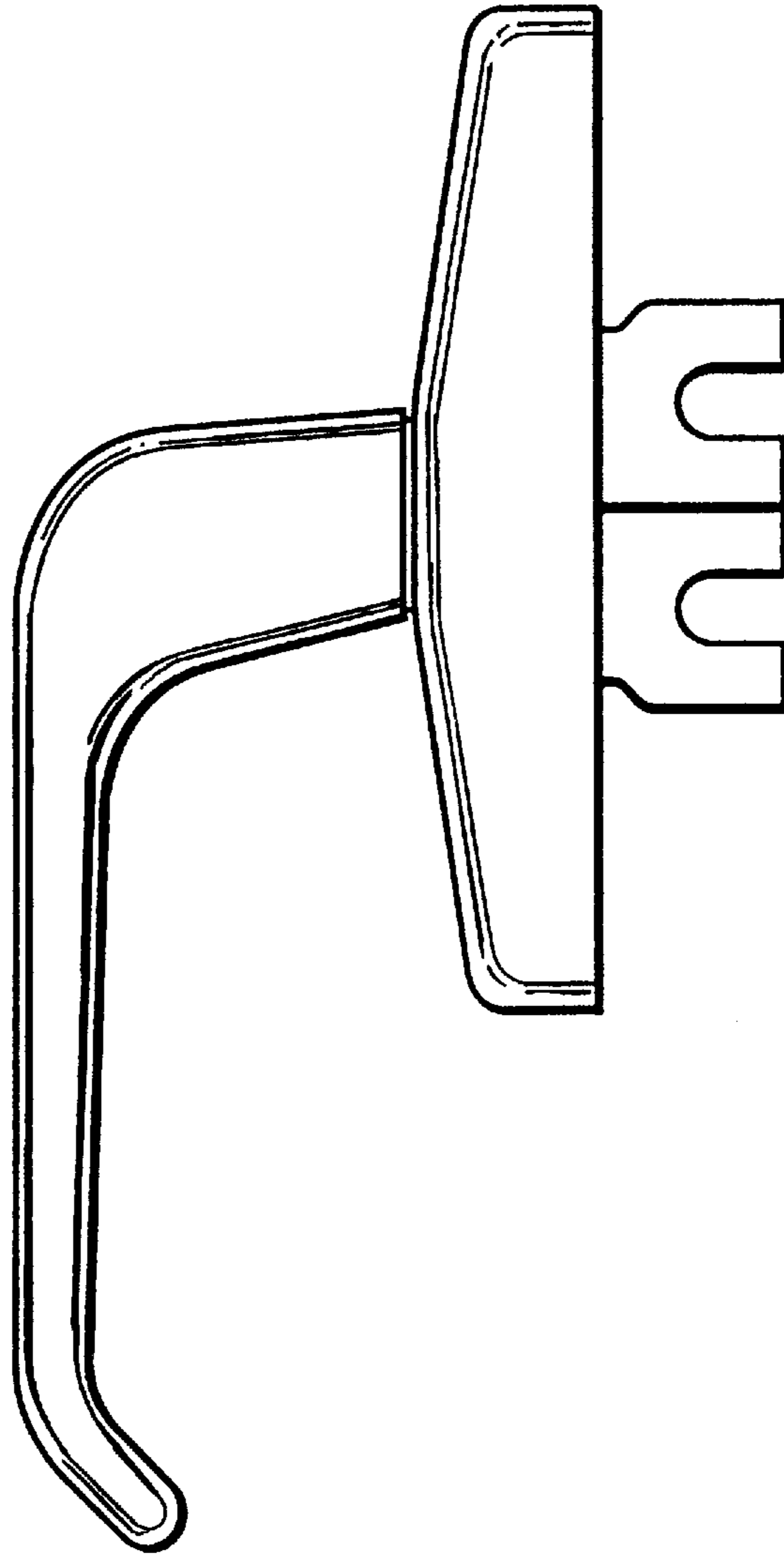

Fig. 39

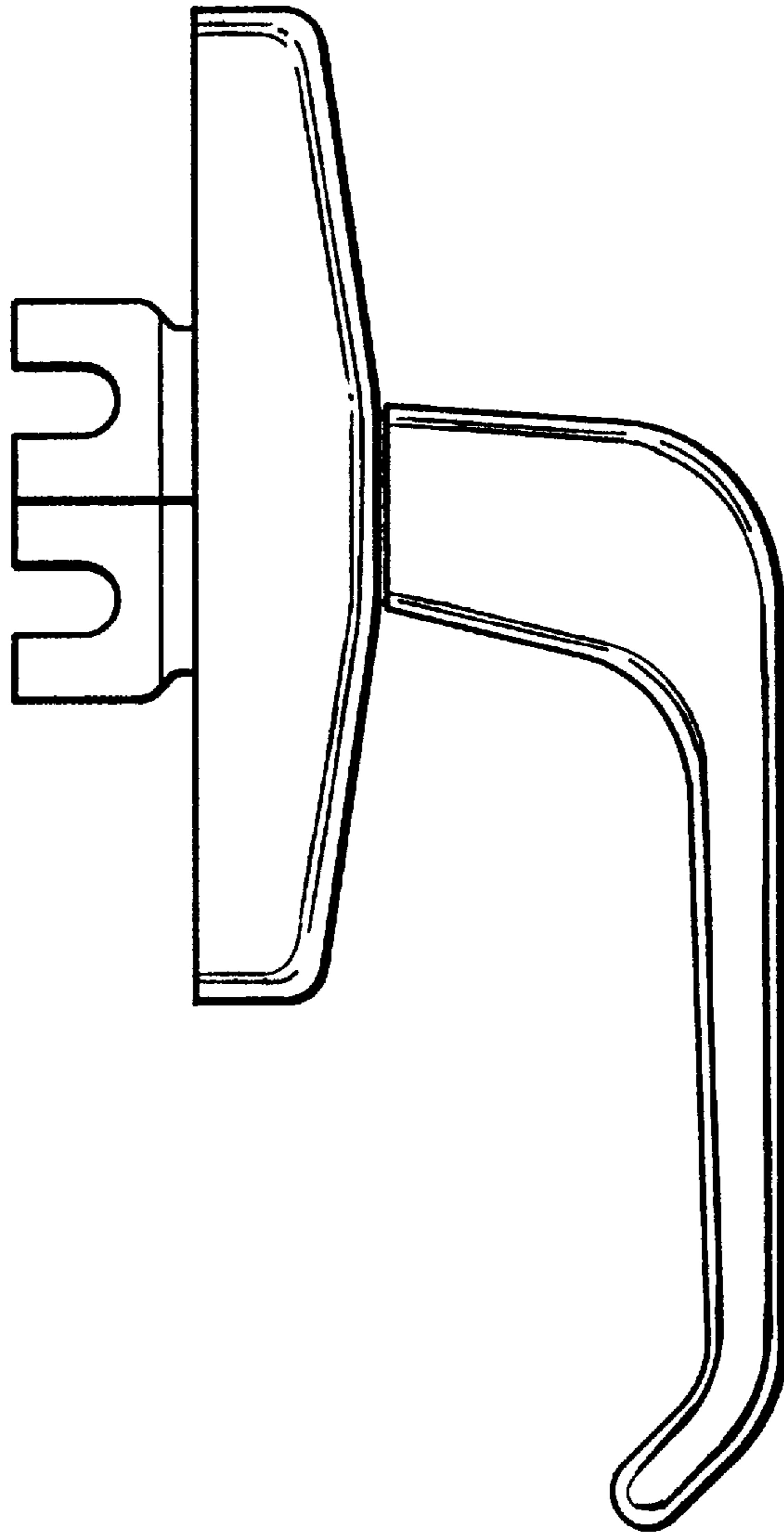

Fig. 40

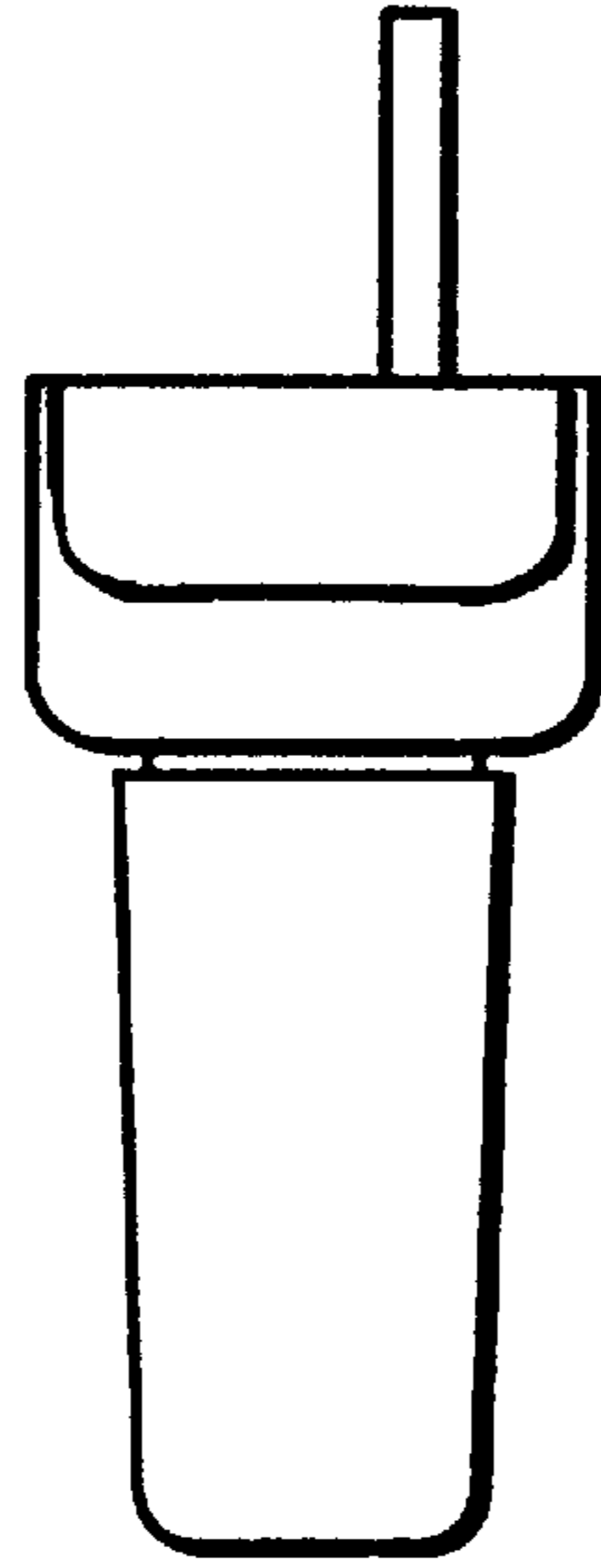

Fig. 41

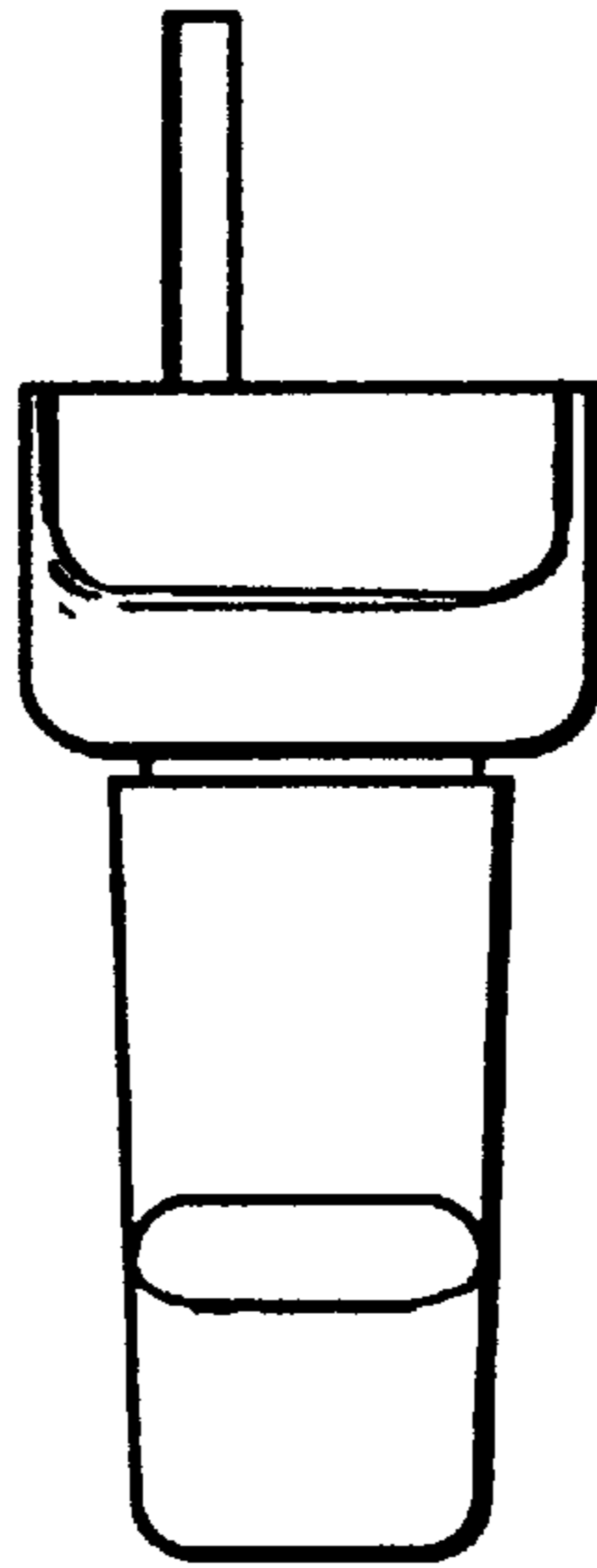

Fig. 42