



US00D400754S

# United States Patent [19] Alferink

[11] **Patent Number: Des. 400,754**

[45] **Date of Patent: \*\*Nov. 10, 1998**

[54] **COFFEE MAKER**

D. 371,037 6/1996 De Felip ..... D7/309  
4,909,136 3/1990 Newman et al. .... 99/295 X

[75] Inventor: **Johannes Raymundus Alferink,**  
Rotterdam, Netherlands

### OTHER PUBLICATIONS

Coffee Maker (bottom left), Form 105 Jan. 1984, p. 56.

[73] Assignee: **Sara Lee/DE N.V.,** Utrecht,  
Netherlands

*Primary Examiner*—M. N. Pandozzi  
*Attorney, Agent, or Firm*—Rhodes, Coats & Bennett, L.L.P.

[\*\*] Term: **14 Years**

### [57] CLAIM

[21] Appl. No.: **71,168**

The ornamental design for a coffee maker, as shown and described.

[22] Filed: **May 22, 1997**

### [30] Foreign Application Priority Data

### DESCRIPTION

Nov. 27, 1996 [XH] Hague Agreement ..... DM/038357

FIG. 1 is a front elevational view of a coffee maker showing my new design;

[51] **LOC (6) Cl.** ..... **07-01**

FIG. 2 is a right front perspective view thereof;

[52] **U.S. Cl.** ..... **D7/309; D7/310; D7/311**

FIG. 3 is a right side elevational view thereof;

[58] **Field of Search** ..... D7/309, 310, 311,  
D7/305; 99/304, 306, 275, 286, 295

FIG. 4 is a left side elevational view thereof;

FIG. 5 is a rear elevational view thereof;

### [56] References Cited

FIG. 6 is a top view thereof; and,

FIG. 7 is a bottom view thereof.

### U.S. PATENT DOCUMENTS

D. 344,656 3/1994 De Felip ..... D7/309

**1 Claim, 4 Drawing Sheets**

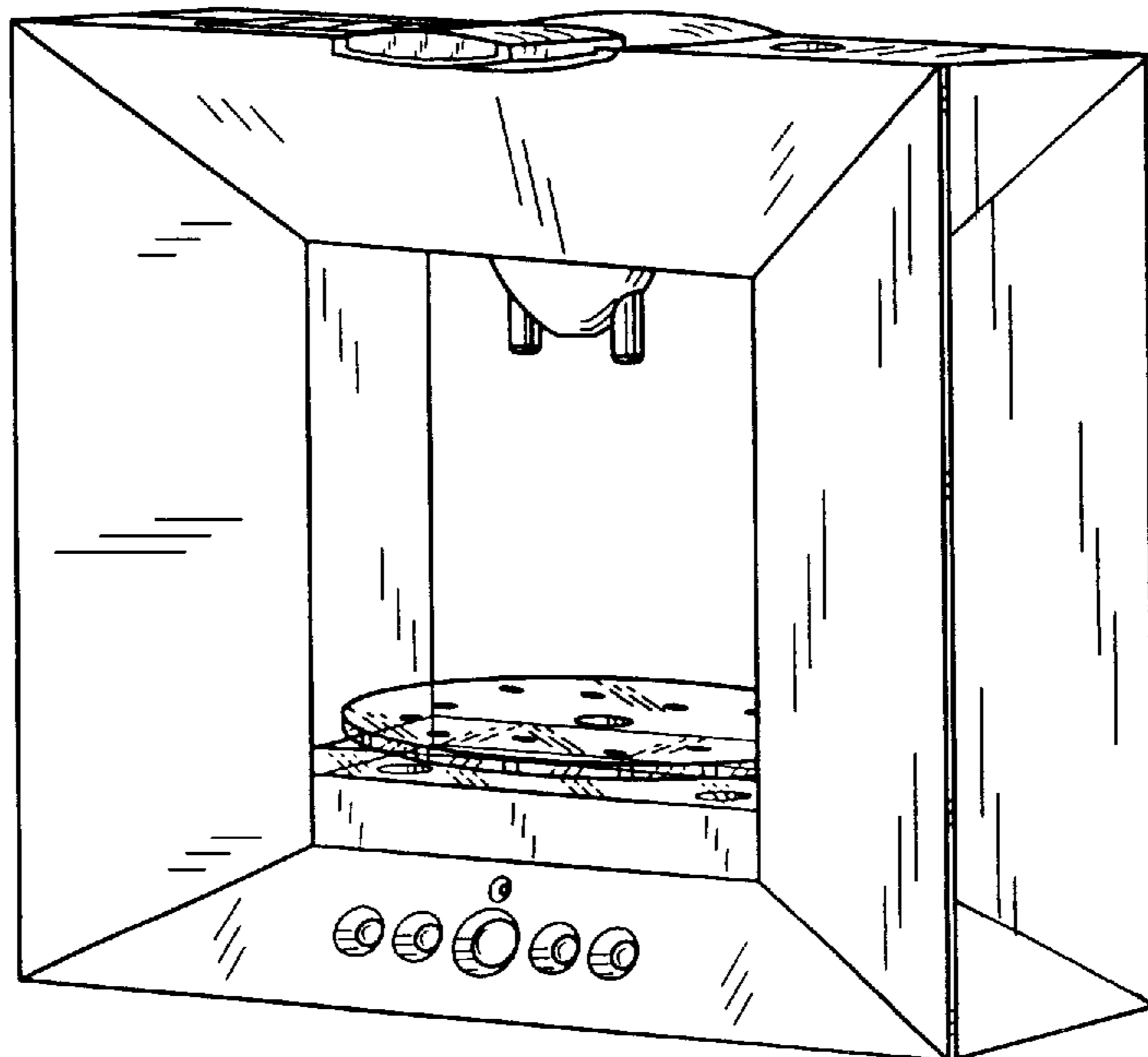

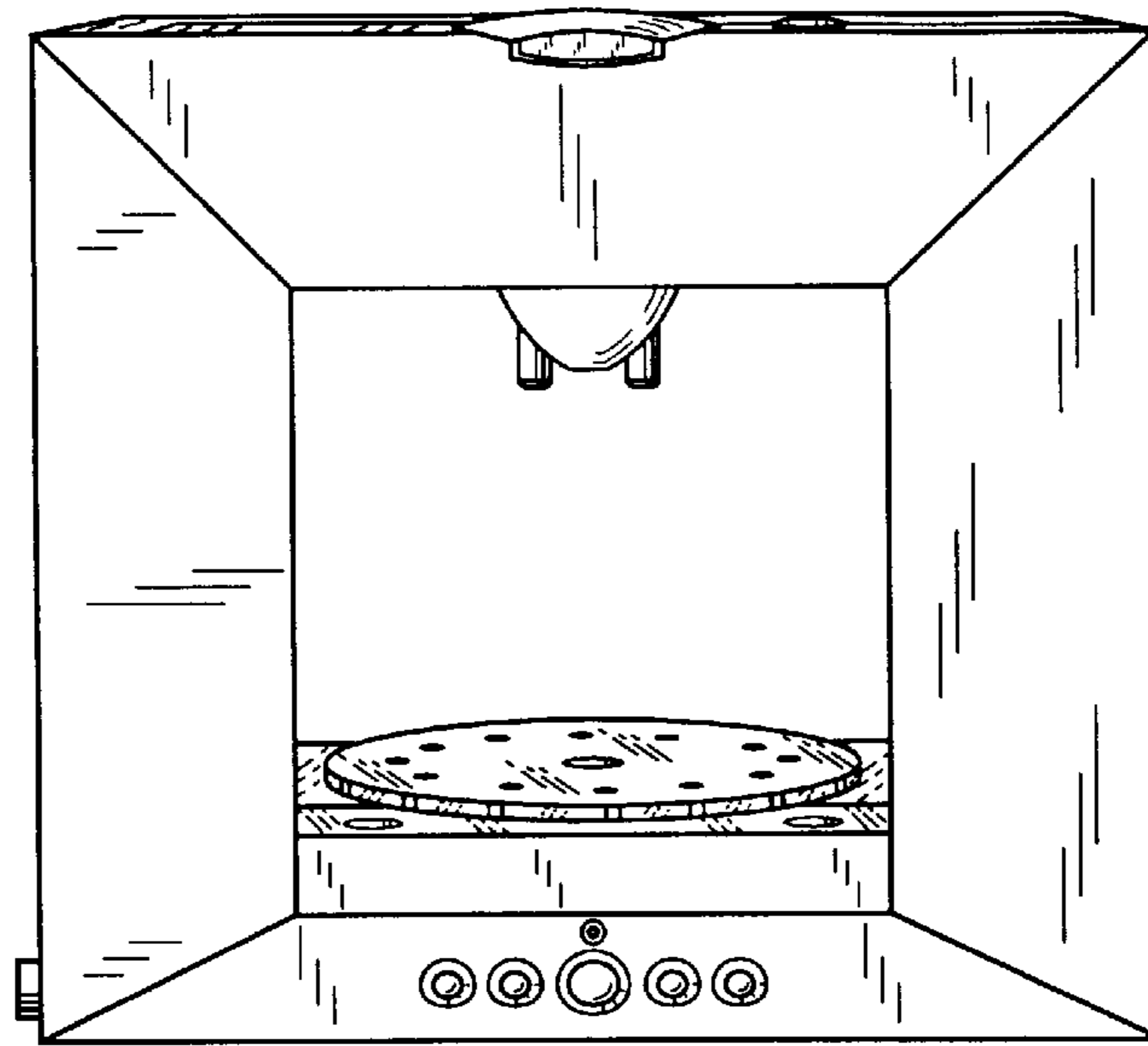

FIG. 1

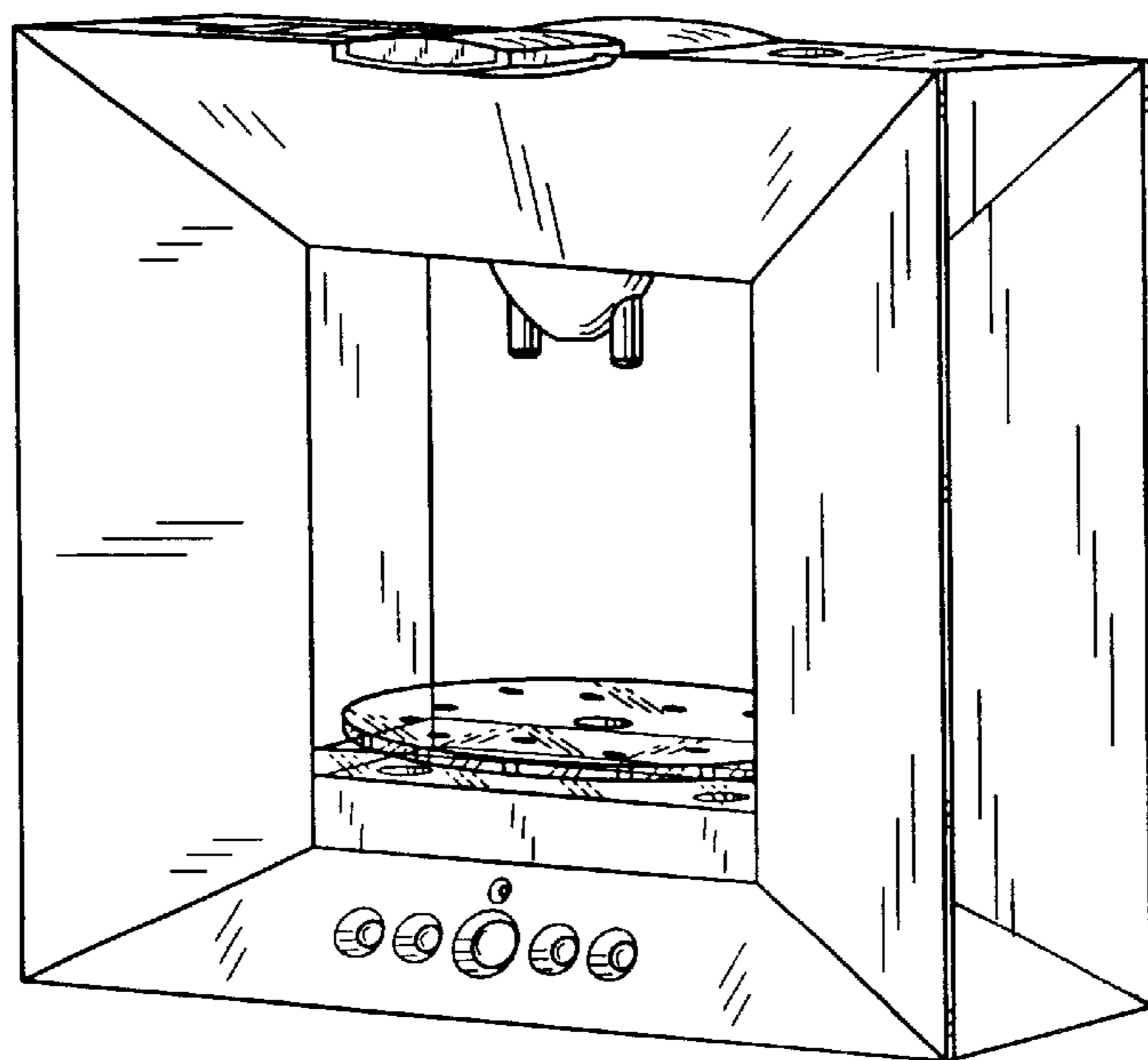

FIG. 2

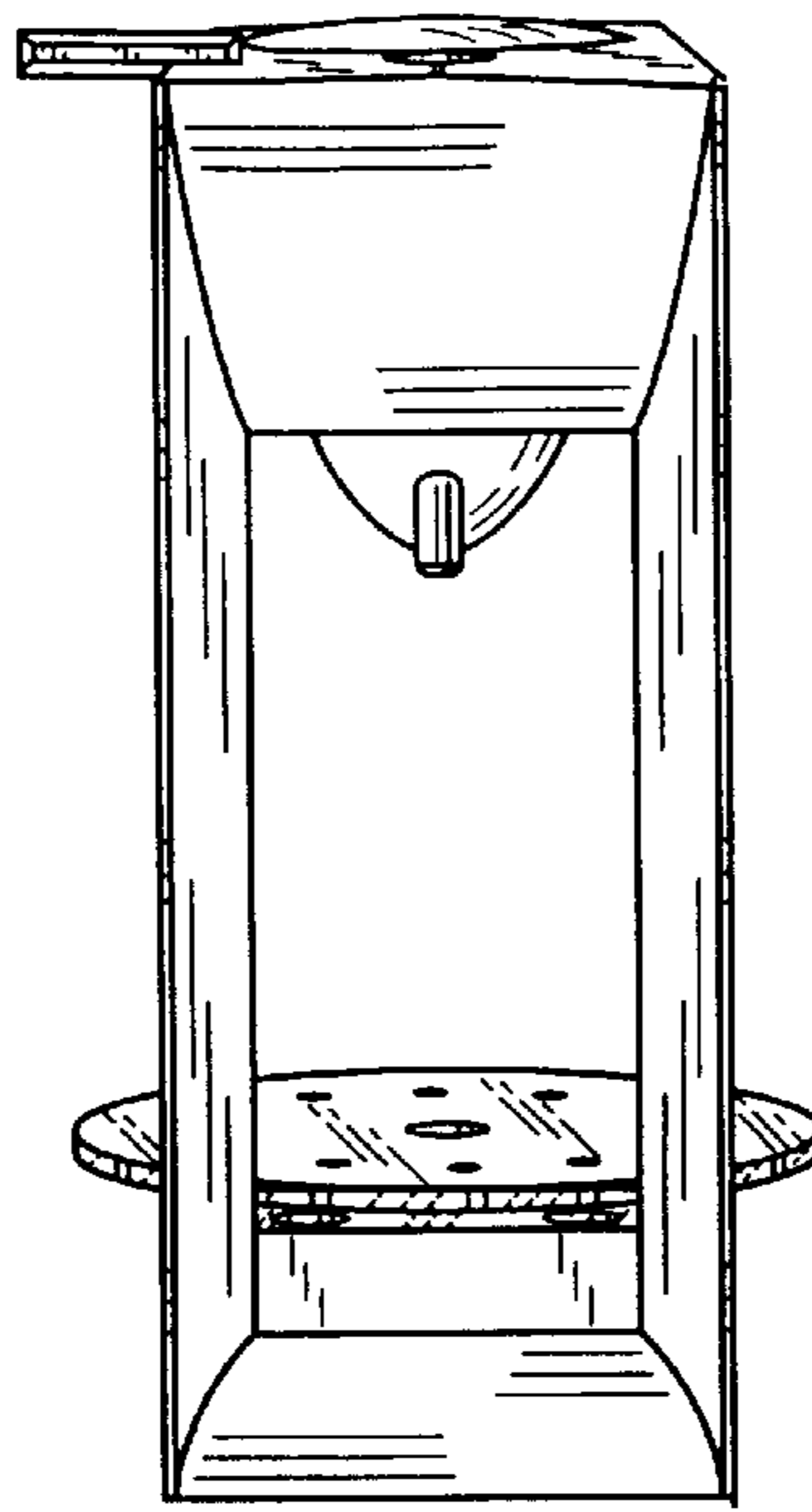

FIG. 3

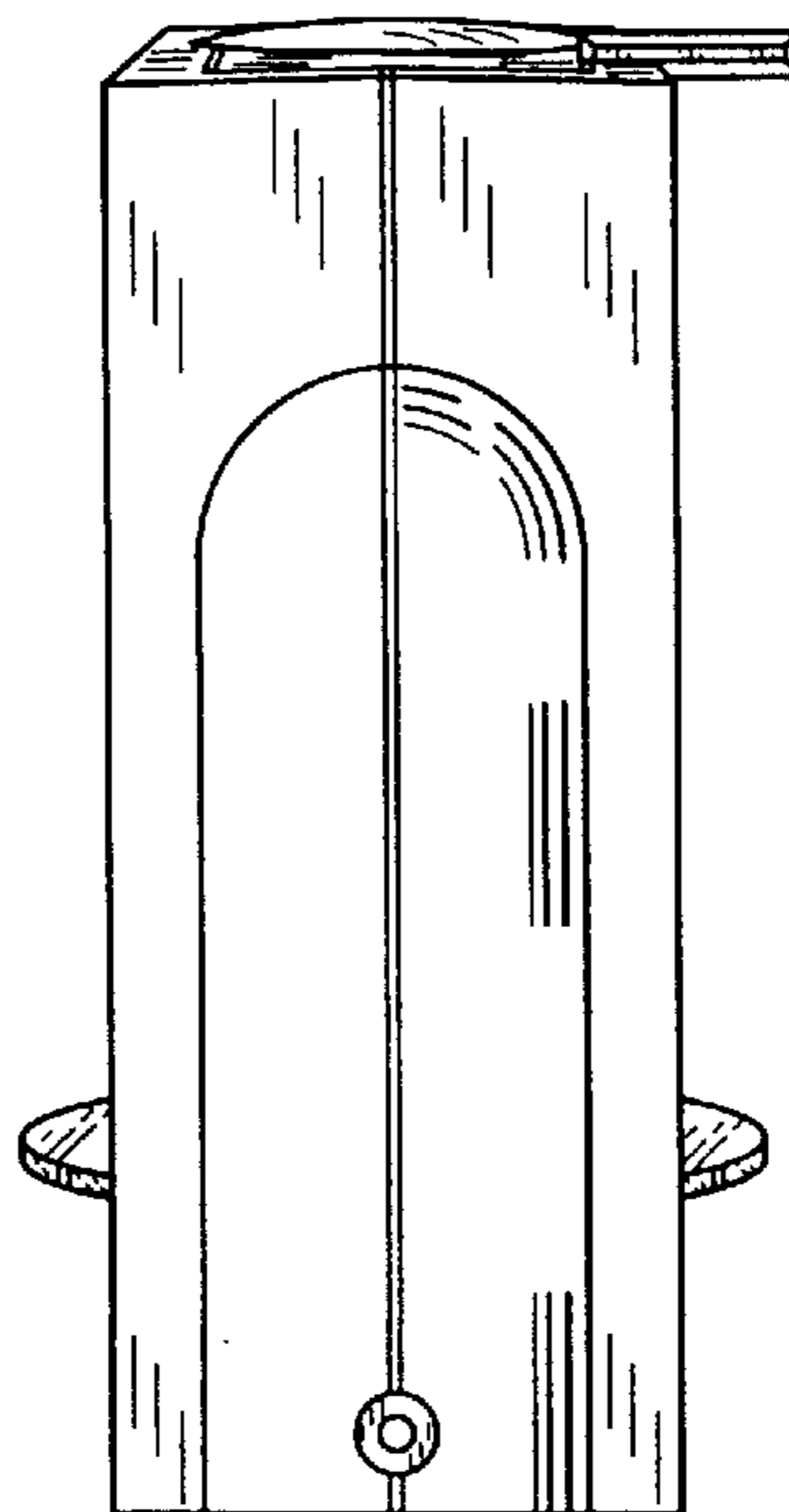

FIG. 4

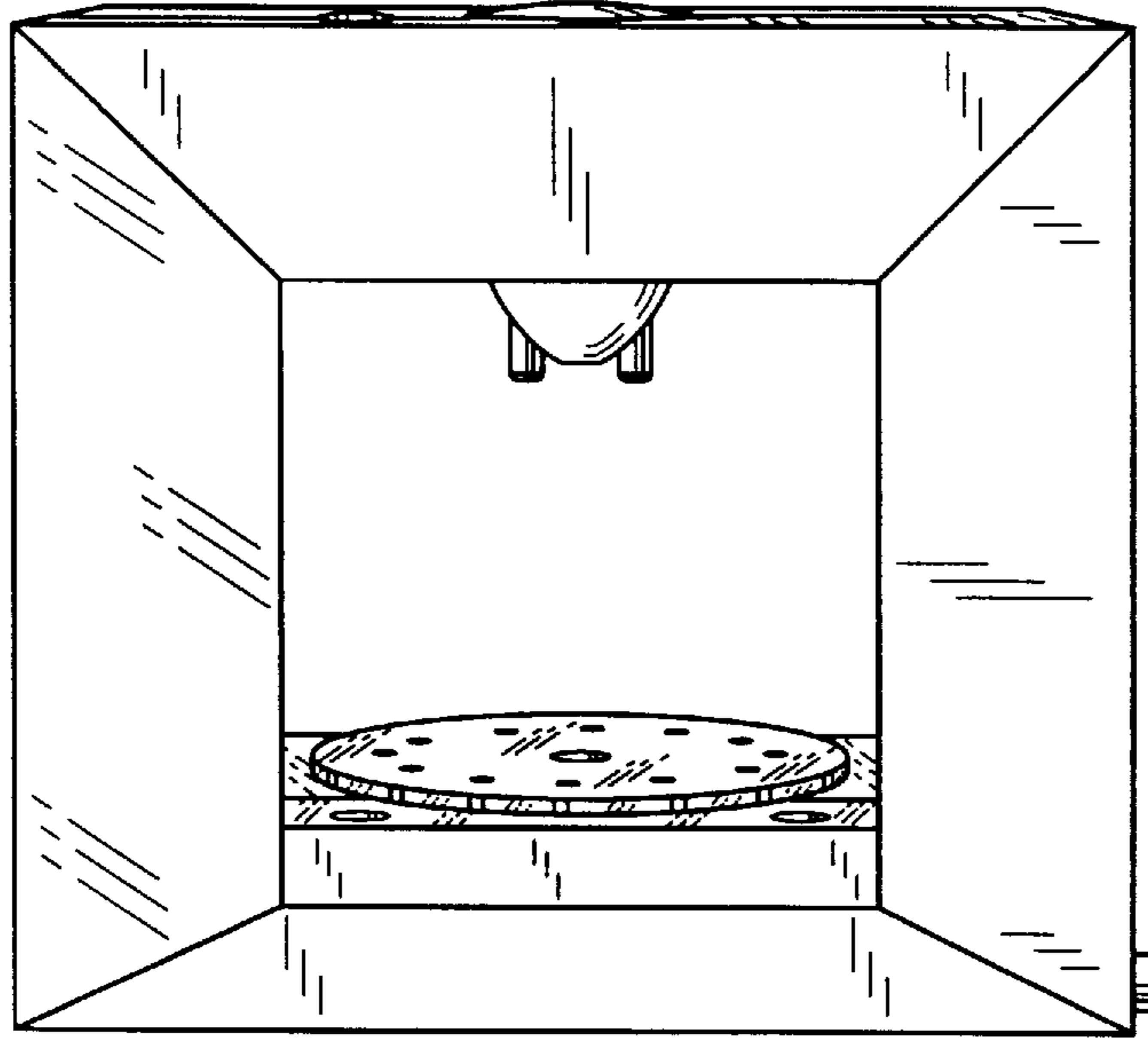

FIG. 5

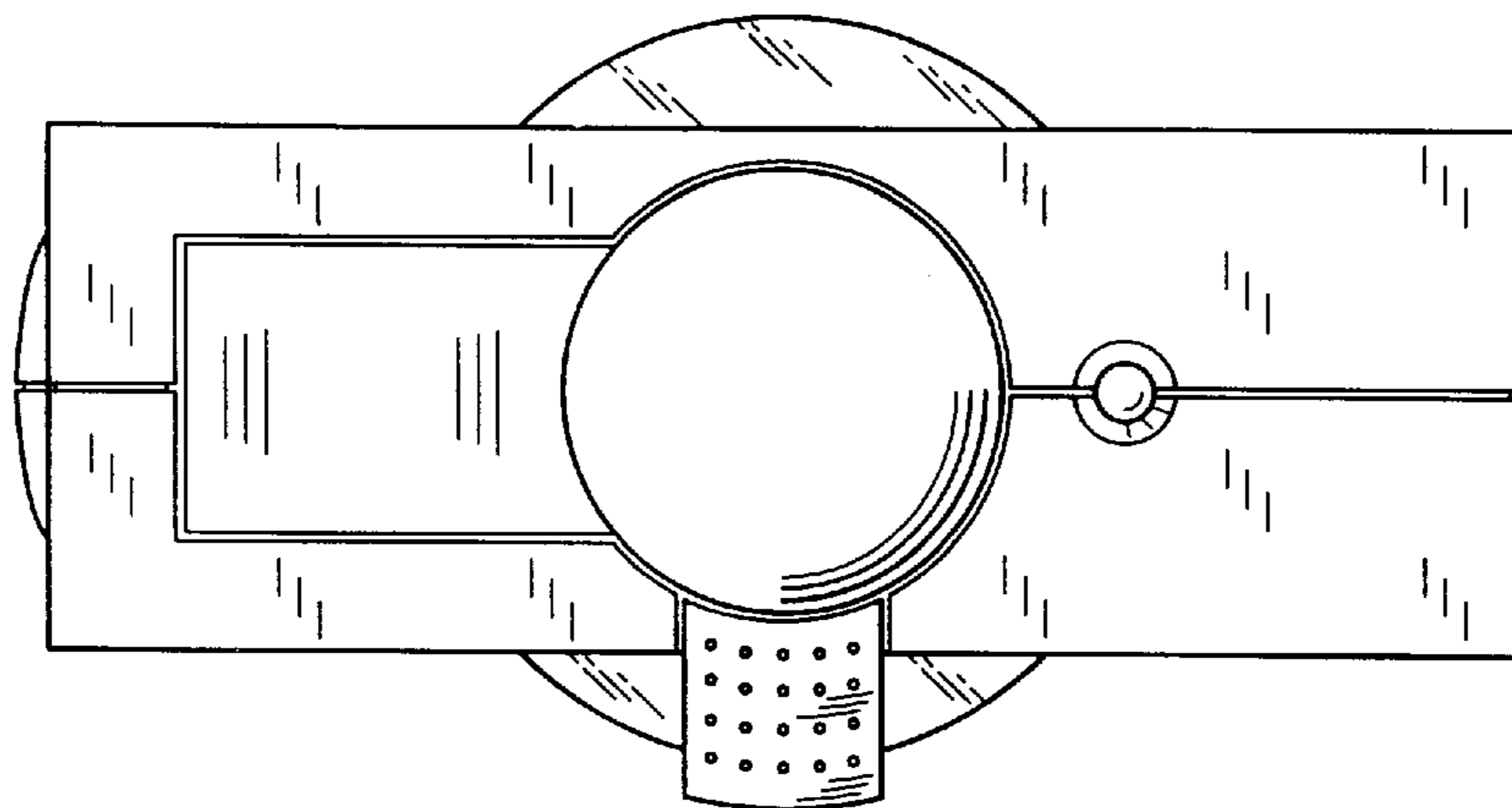

FIG. 6

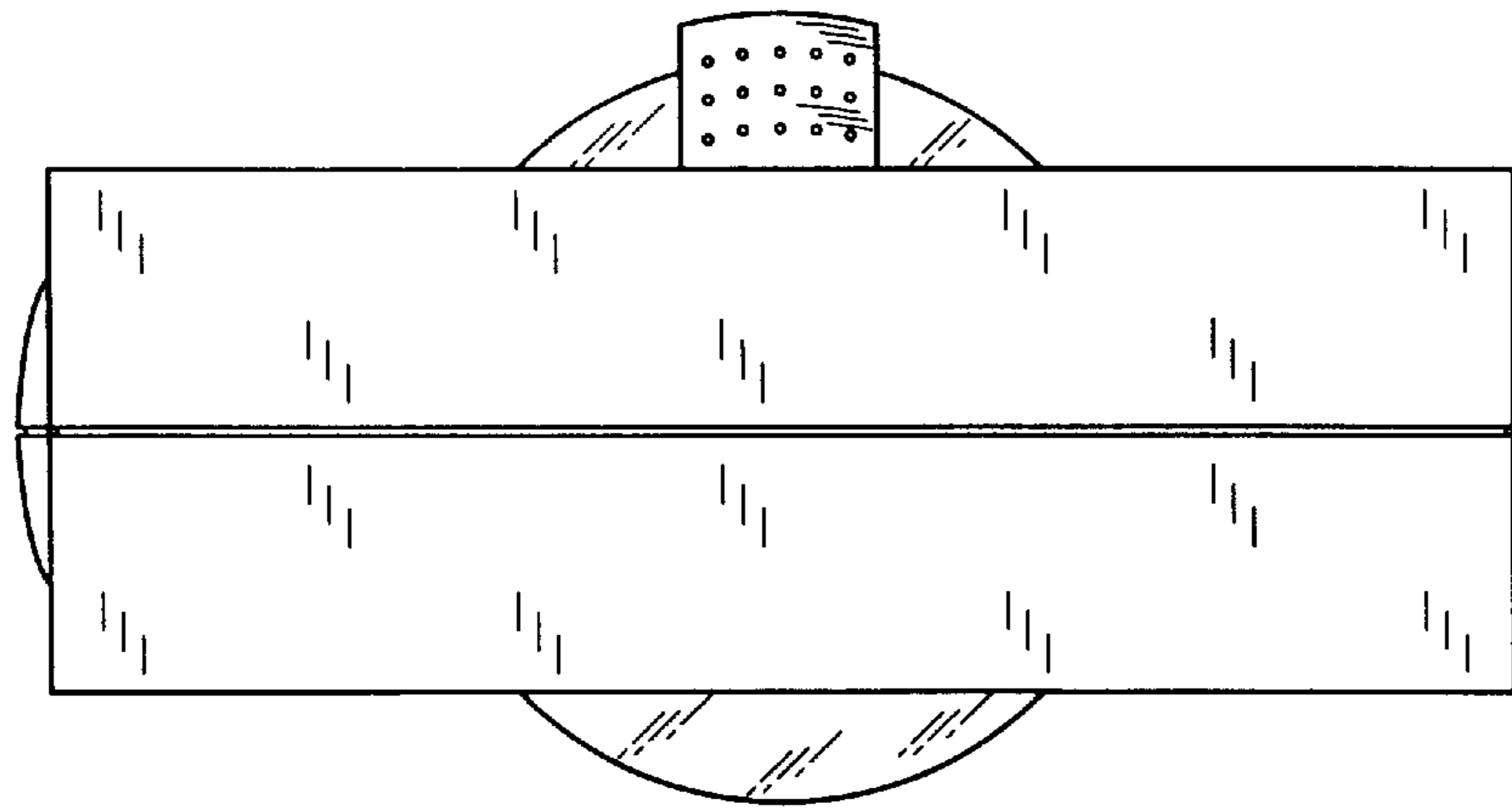

FIG. 7