



US00D400653S

United States Patent [19]
Smith

[11] **Patent Number: Des. 400,653**
[45] **Date of Patent: **Nov. 3, 1998**

[54] **COMBINED BATHTUB AND SHOWER ENCLOSURE**

[75] Inventor: **Iain M. Smith**, Vernon, Canada
[73] Assignee: **Kohler Ltd./Kohler Ltee**, Etobicoke, Canada
[**] Term: **14 Years**

[21] Appl. No.: **64,941**
[22] Filed: **Jan. 15, 1997**

[51] **LOC (6) Cl.** **23-01**
[52] **U.S. Cl.** **D23/275**
[58] **Field of Search** D23/275-283;
4/675-678; 137/801

[56] **References Cited**

U.S. PATENT DOCUMENTS

D. 238,275	12/1975	Folden .	
D. 238,276	12/1975	Alexander .	
D. 254,148	2/1980	Alexander .	
D. 310,557	9/1990	Smith	D23/275
D. 314,451	2/1991	Smith	D23/283
D. 315,895	4/1991	Smith	D23/275
D. 345,783	4/1994	Kohler, Jr.	D23/275
D. 347,049	5/1994	Clark et al.	D23/275
D. 356,363	3/1995	Smith	D23/275
D. 379,216	5/1997	Salach et al.	D23/277

OTHER PUBLICATIONS

Undated Hytech ad showing an AC100/101 tub, admitted prior art.
Undated Fiat ad, p. 46, showing a model MTSH-319 bath, admitted prior art.

Primary Examiner—Louis S. Zarfes
Assistant Examiner—Eric Watterson

Attorney, Agent, or Firm—Quarles & Brady

[57] **CLAIM**

The ornamental design for a combined bathtub and shower enclosed, as shown and described.

DESCRIPTION

FIG. 1 is a right, top, front perspective view of a combined bathtub and shower enclosure embodying my new design; FIG. 2 is a front elevational view thereof; FIG. 3 is a rear elevational view thereof; FIG. 4 is a top plan view thereof; FIG. 5 is a bottom plan view thereof; FIG. 6 is a right side elevational view thereof; FIG. 7 is a left side elevational view thereof; FIG. 8 is a cross-sectional view taken along line 8—8 of FIG. 6; FIG. 9 is a cross-sectional view taken along line 9—9 of FIG. 2; FIG. 10 is a cross-sectional view taken along line 10—10 of FIG. 4; FIG. 11 is a cross-sectional view taken along line 11—11 of FIG. 4; and, FIG. 12 is a cross-sectional view of a second embodiment which is a mirror image of that shown in FIG. 9, the front elevational view being identical to that shown in FIG. 2, the rear elevational view being a mirror image of that shown in FIG. 3, the top plan view being identical to that shown in FIG. 4, the bottom plan view being a mirror image of that shown in FIG. 5, the left side elevational view being a mirror image of that shown in FIG. 6, and the right side elevational view being a mirror image of that shown in FIG. 7. The broken line representation of a hole in FIGS. 7 and 10 is for the purpose of illustration only, and forms no part of the claimed design.

1 Claim, 8 Drawing Sheets

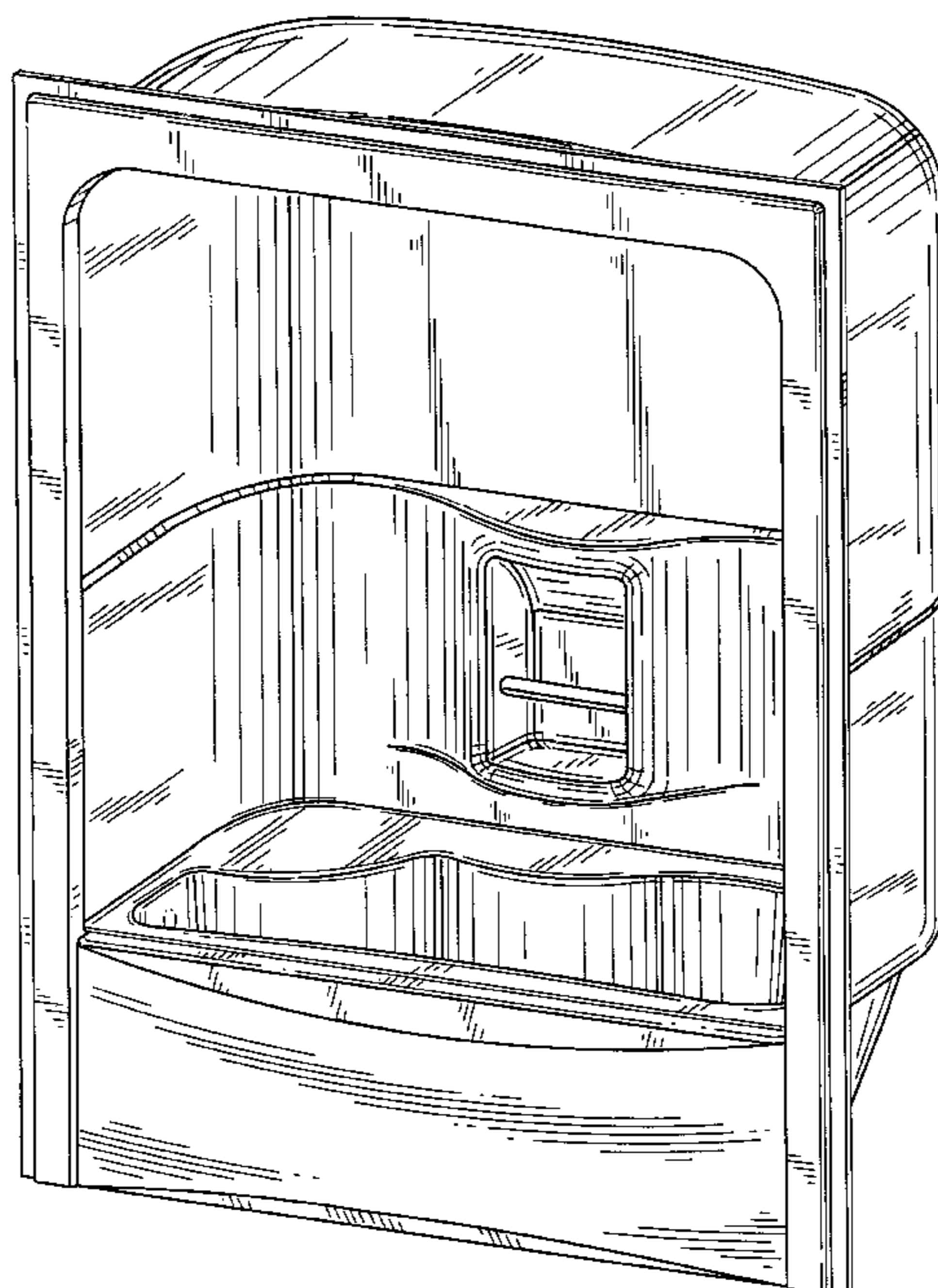

FIG. 1

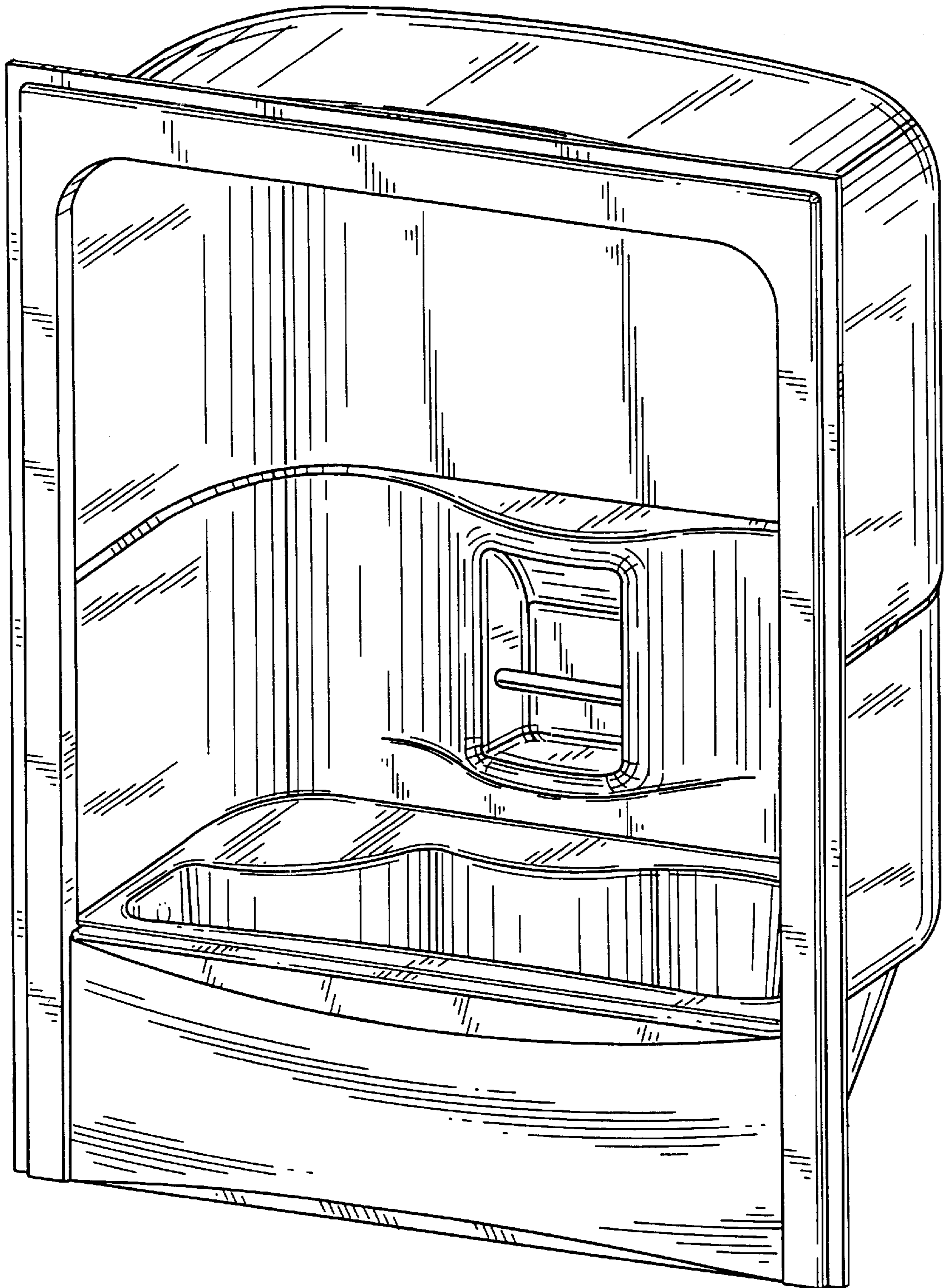

FIG. 2

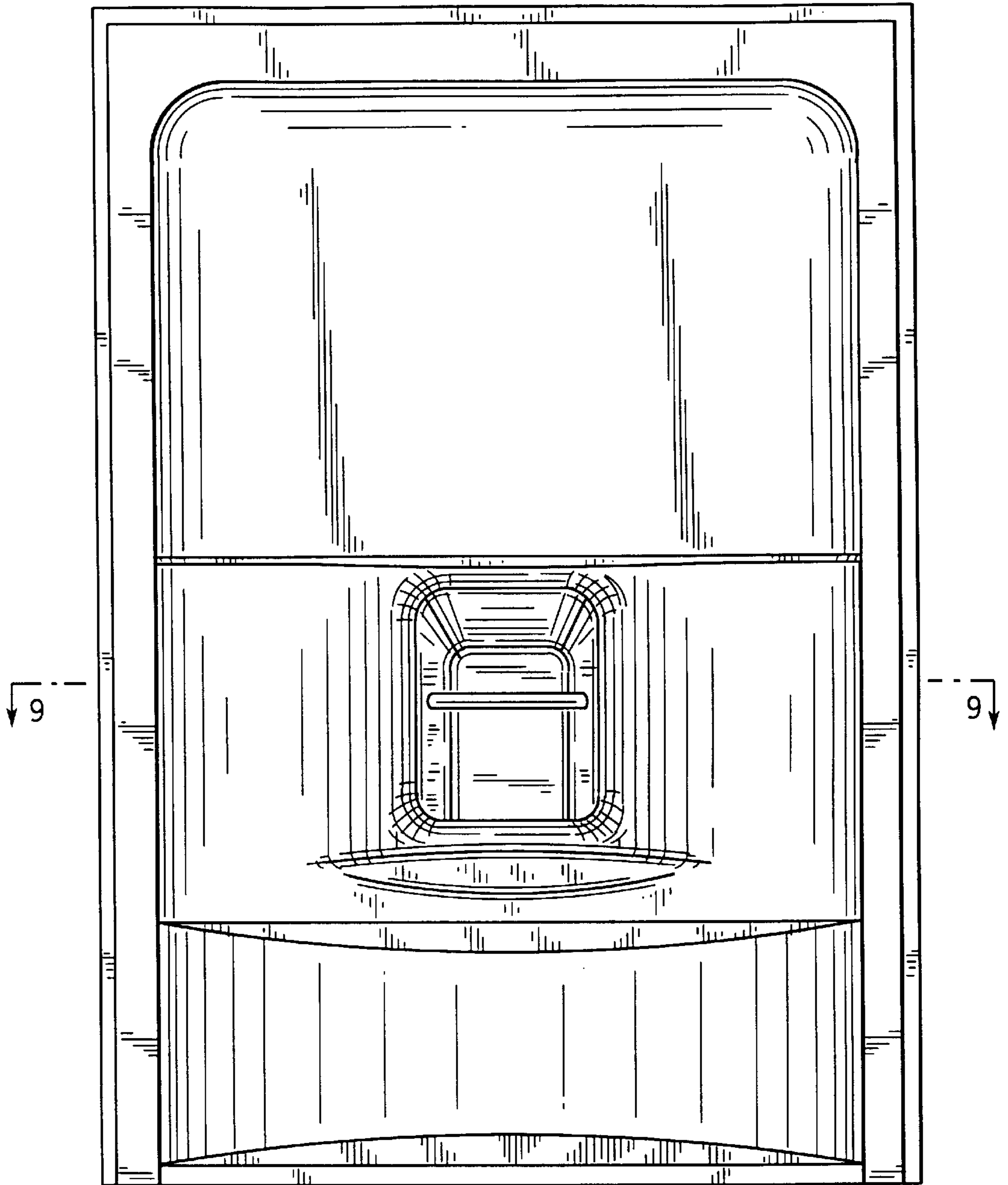

FIG. 3

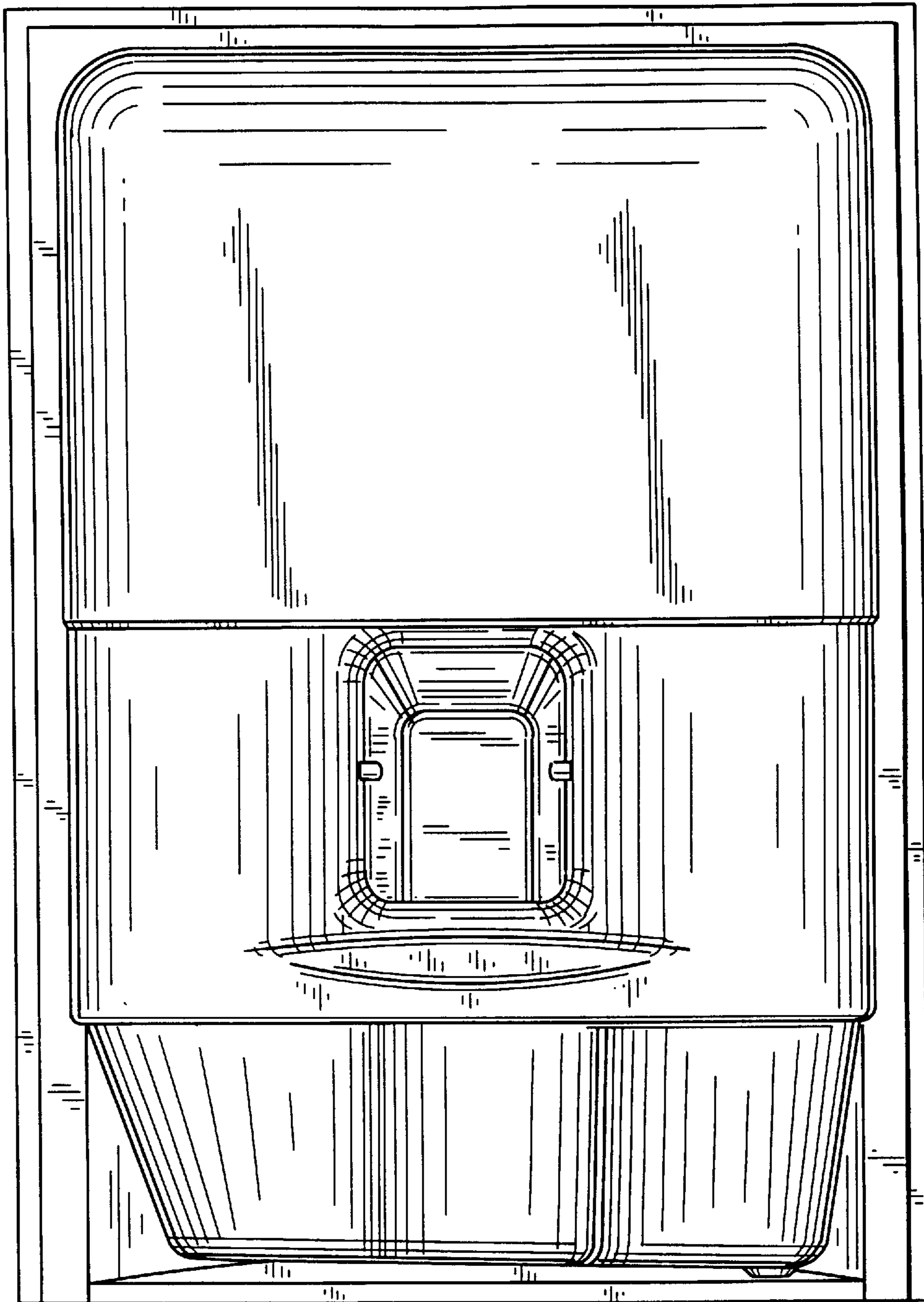

FIG. 4

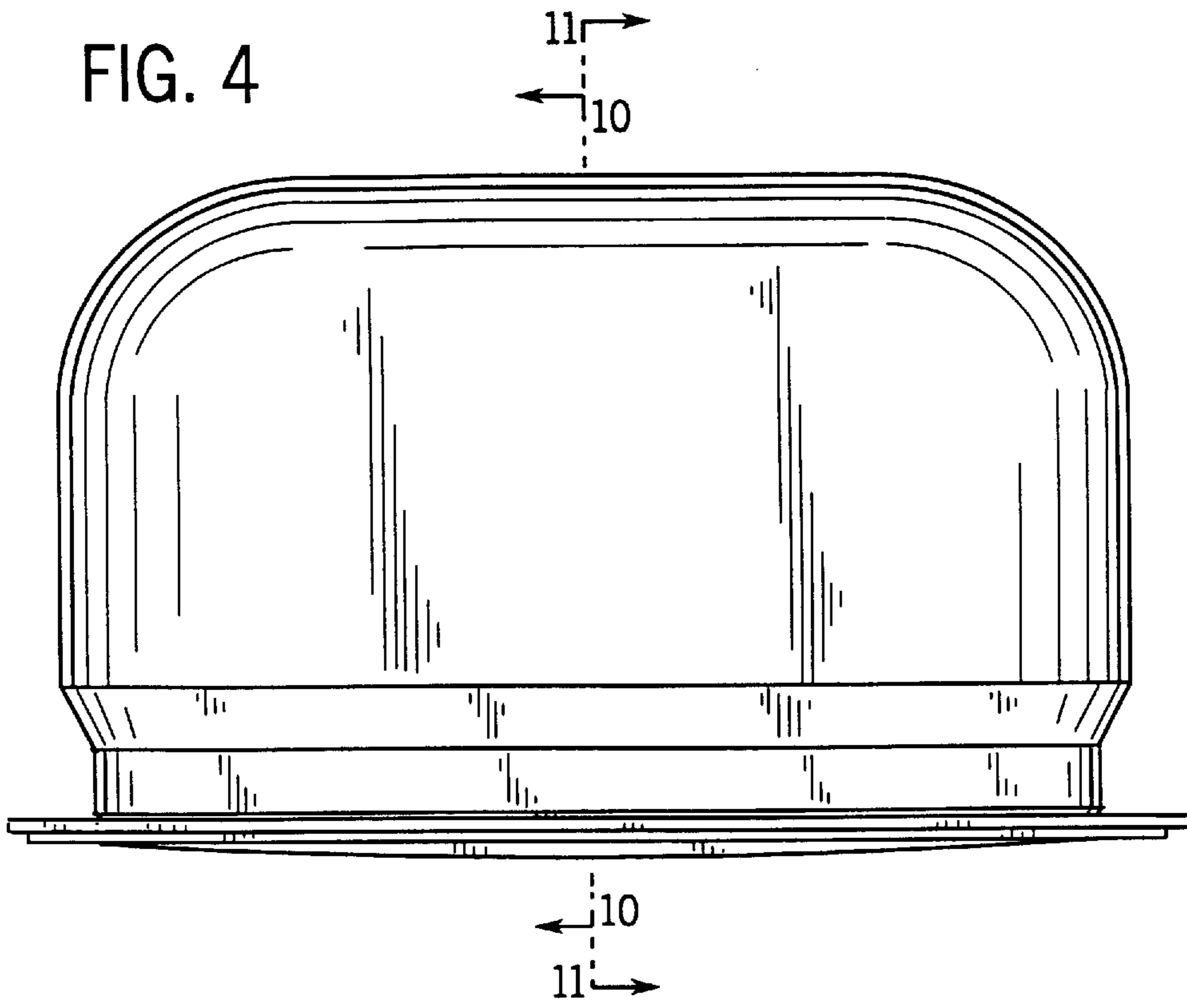
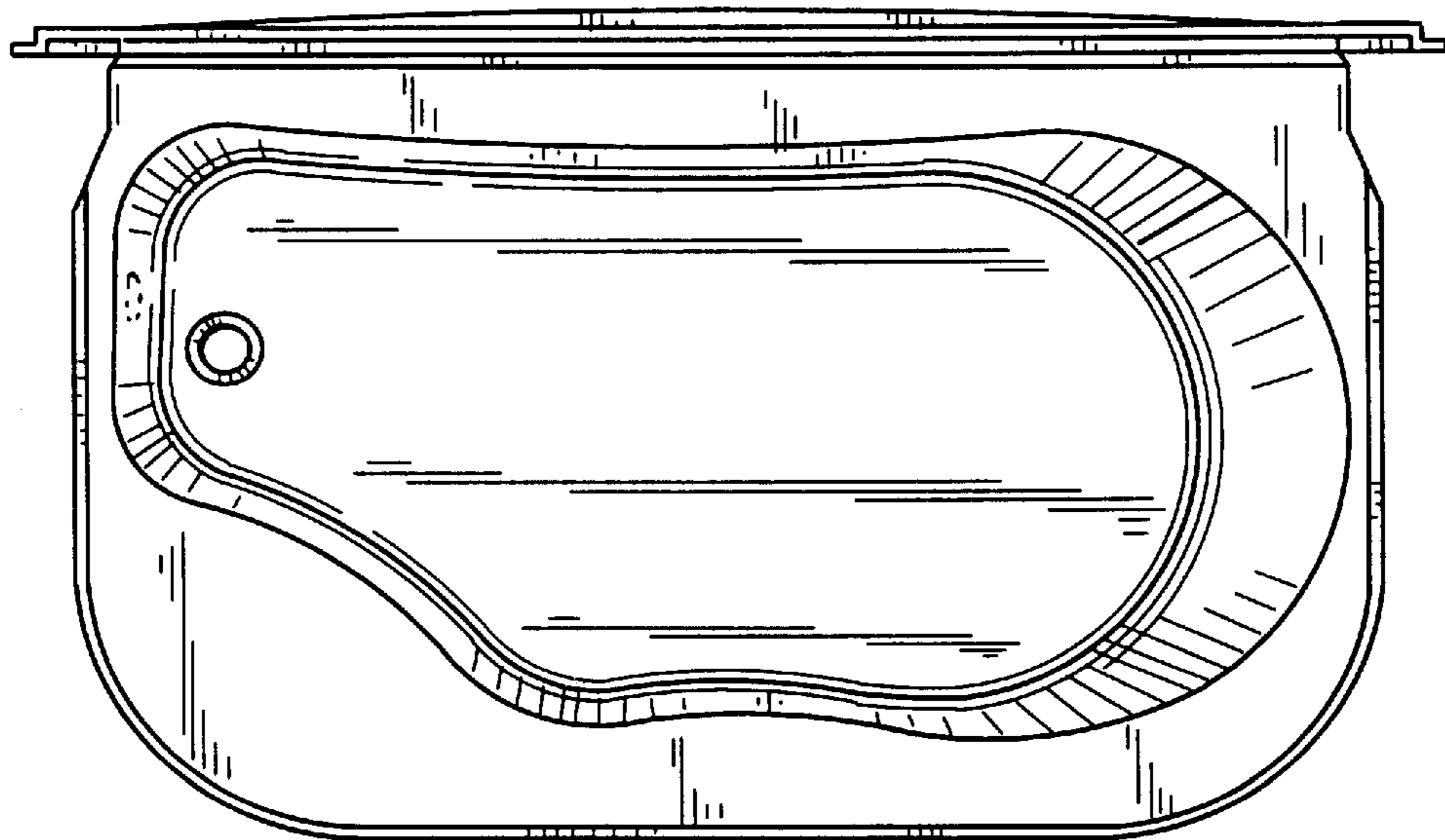

FIG. 5



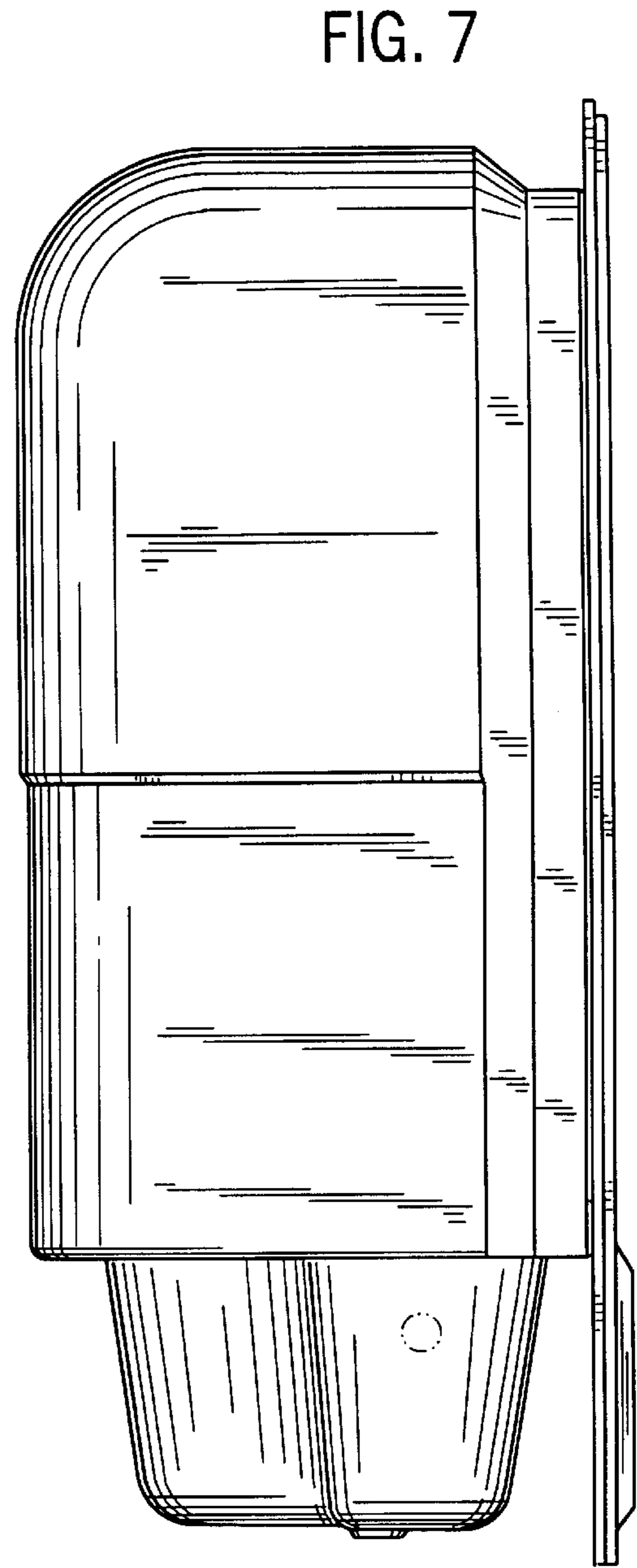
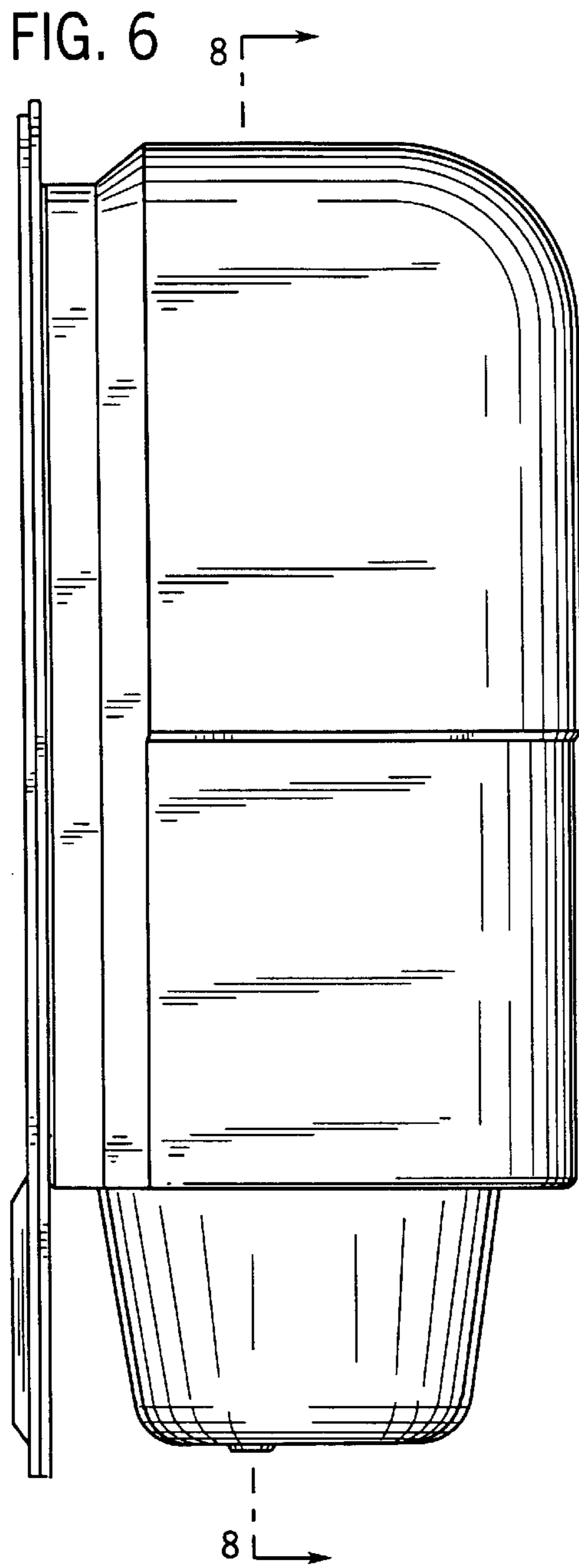

FIG. 8

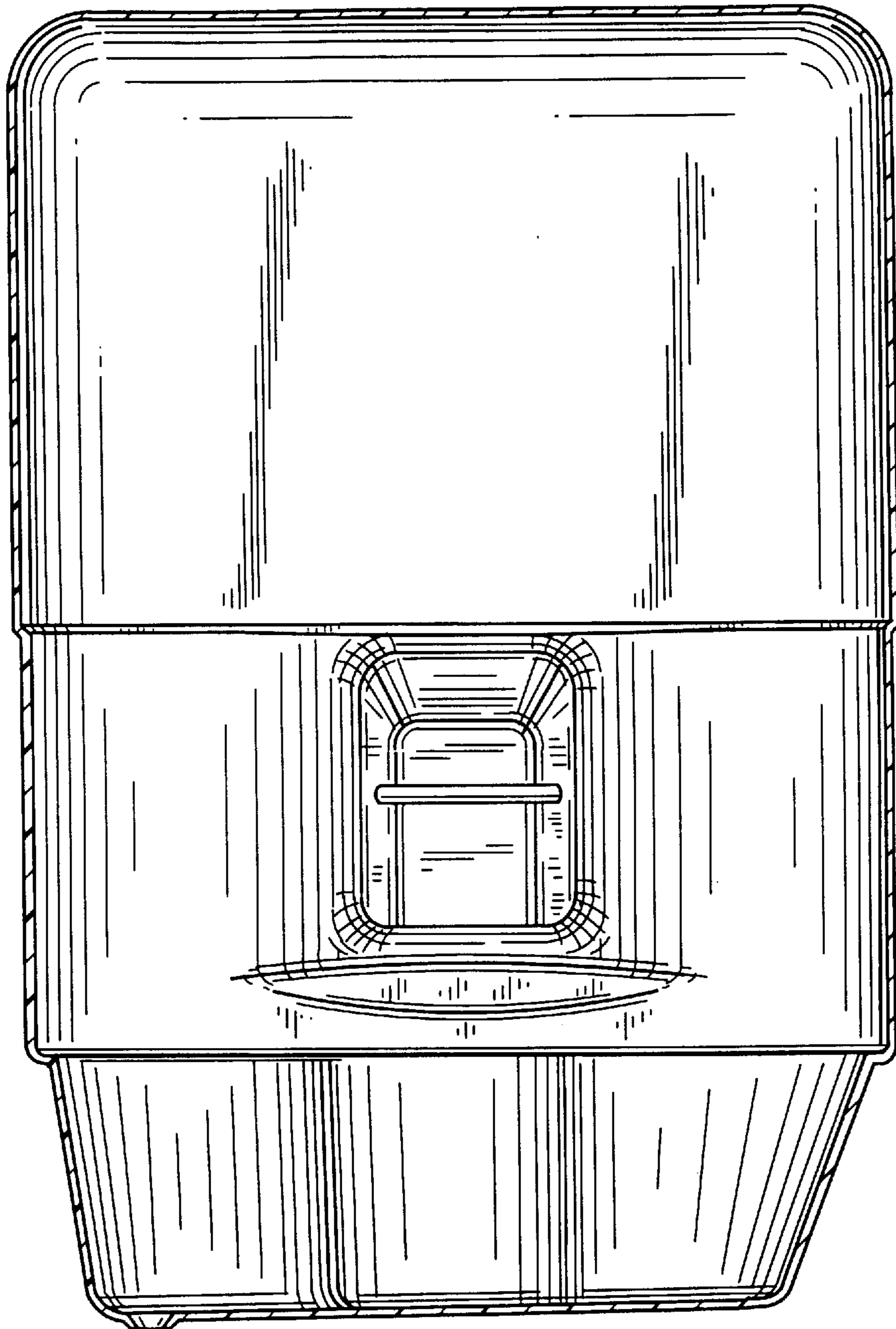

FIG. 9

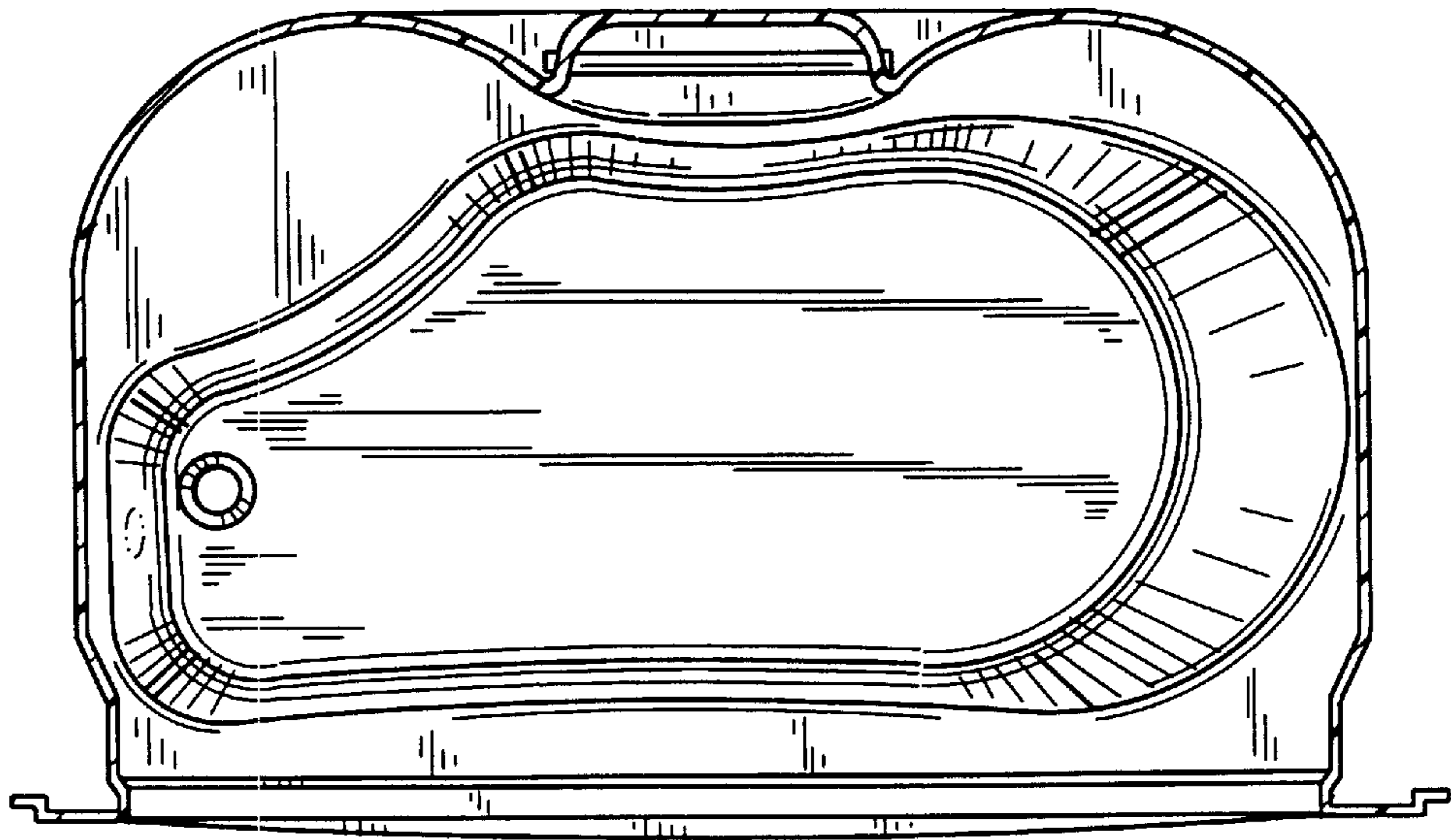

FIG. 12

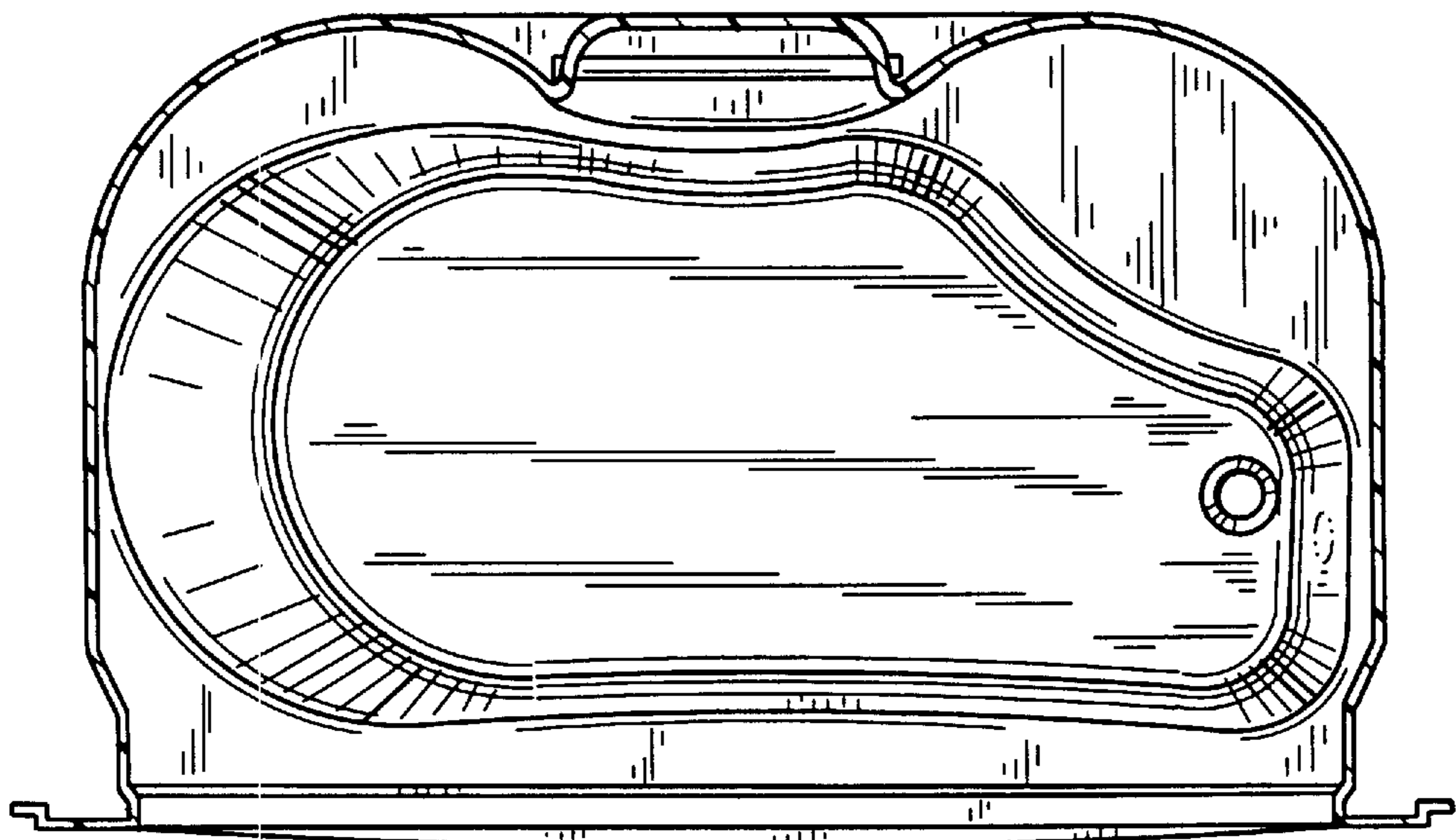
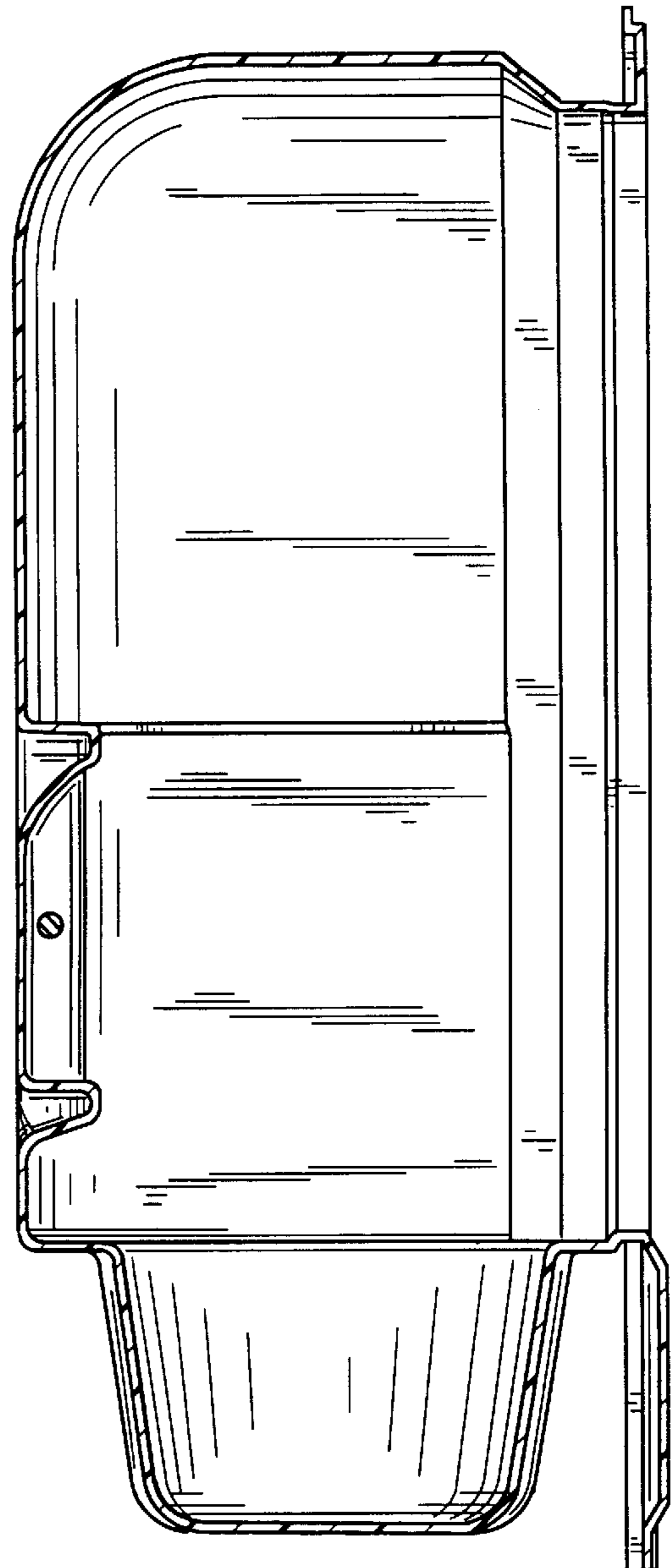

FIG. 10



FIG. 11



UNITED STATES PATENT AND TRADEMARK OFFICE
CERTIFICATE OF CORRECTION

PATENT NO. : D400,653
DATED : November 3, 1998
INVENTOR(S) : Iain M. Smith

It is certified that error appears in the above-identified patent and that said Letters Patent is hereby corrected as shown below:

ON THE TITLE PAGE:

Item [56]; References Cited; U.S. PATENT DOCUMENTS:
"D.315,895 4/1991" should read --D.315,195 3/1991--

Signed and Sealed this
Twenty-fifth Day of May, 1999

Attest:

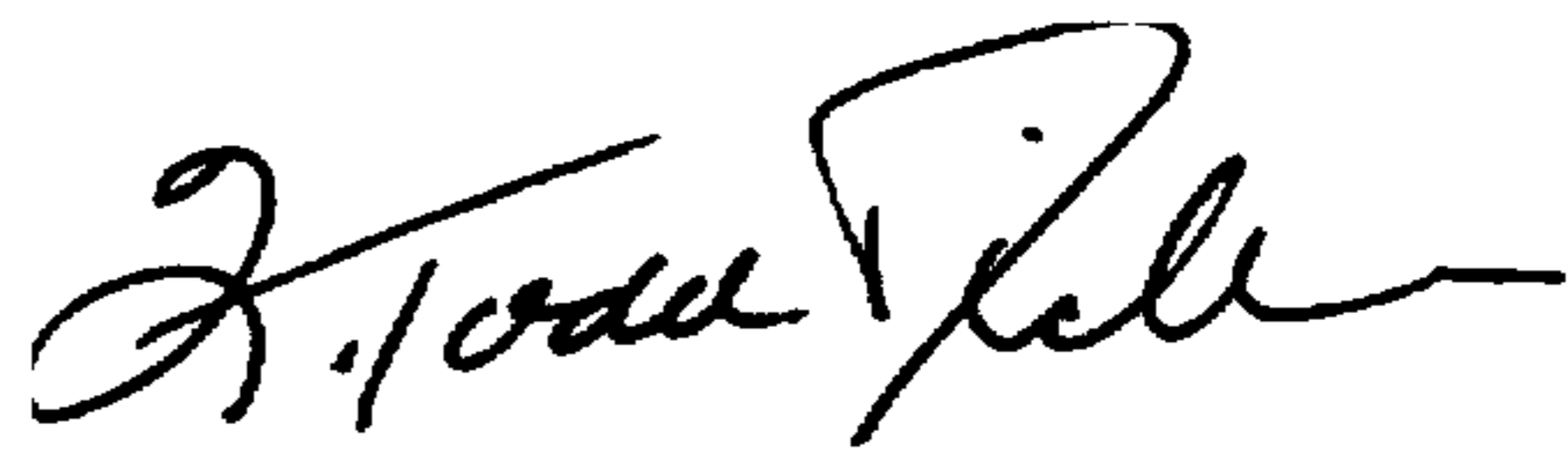

Q. TODD DICKINSON

Attesting Officer

Acting Commissioner of Patents and Trademarks