

US00D400610S

United States Patent [19]
Cameron et al.

[11] **Patent Number: Des. 400,610**
[45] **Date of Patent: **Nov. 3, 1998**

[54] **GOLF CLUB HEAD**

[75] Inventors: **Don T. Cameron**, Carlsbad; **Scott A. Knutson**, El Cajon; **Terrill R. McCabe**, Carlsbad, all of Calif.

[73] Assignee: **Cobra Golf, Inc.**, Carlsbad, Calif.

[**] Term: **14 Years**

[21] Appl. No.: **73,222**

[22] Filed: **Jul. 3, 1997**

Related U.S. Application Data

[63] Continuation-in-part of Ser. No. 065,179, Jan. 23, 1997.

[51] **LOC (6) Cl.** **21-02**

[52] **U.S. Cl.** **D21/219**

[58] **Field of Search** D21/217-219;
473/324, 327, 340, 341

[56] **References Cited**

U.S. PATENT DOCUMENTS

- D. 255,373 6/1980 Solheim D21/219
- D. 256,262 8/1980 Benson D21/219
- D. 271,317 11/1983 Bretl .
- D. 300,443 3/1989 Antonious D21/217
- D. 300,444 3/1989 Antonious D21/217
- D. 351,443 10/1994 Caugh et al. .
- D. 364,205 11/1995 Duclos D21/217
- D. 368,751 4/1996 Rife D21/219
- D. 369,393 4/1996 Takahashi et al. D21/217
- D. 373,161 8/1996 Schmidt et al. .
- 572,436 12/1896 Mills .
- 873,423 12/1907 Govan .
- 922,444 5/1909 Youds .
- 2,429,351 10/1947 Fetterolf .
- 3,134,596 5/1964 Boznos .
- 3,218,072 11/1965 Burr .
- 3,695,618 10/1972 Woolley et al. .
- 3,975,023 8/1976 Inamori .
- 3,989,248 11/1976 Campau .
- 4,156,526 5/1979 Huggins et al. .
- 4,199,144 4/1980 Skelly .
- 4,422,638 12/1983 Tucker .

- 4,679,792 7/1987 Straza et al. .
- 4,681,322 7/1987 Straza et al. .
- 4,730,830 3/1988 Tilley .
- 4,792,140 12/1988 Yamaguchi et al. .
- 4,930,781 6/1990 Allen .
- 5,060,951 10/1991 Allen .
- 5,078,397 1/1992 Aizawa .
- 5,083,778 1/1992 Douglass .
- 5,301,941 4/1994 Allen .
- 5,346,213 9/1994 Yamada .
- 5,398,929 3/1995 Kitaichi .
- 5,407,202 4/1995 Igarashi .
- 5,425,535 6/1995 Gee .

OTHER PUBLICATIONS

Golf Day; p. 4; IGS mallet putter, upper right of page, Jul. 1994.

Primary Examiner—Sandra L. Morris
Assistant Examiner—Mitchell I. Siegel
Attorney, Agent, or Firm—Pennie & Edmonds LLP

[57] **CLAIM**

The ornamental design for a golf club head, as shown and described.

DESCRIPTION

FIG. 1 is a front perspective view, of the golf club head of the present invention;
FIG. 2 is a top elevational view thereof;
FIG. 3 is a front elevational view thereof;
FIG. 4 is a toe side elevational view thereof;
FIG. 5 is a rear elevational view thereof;
FIG. 6 is a heel side elevational view thereof;
FIG. 7 is a bottom elevational view thereof;
FIG. 8 is a front perspective view of the second embodiment of the golf club head of the present invention;
FIG. 9 is a top elevational view of FIG. 8;
FIG. 10 is a front elevational view of FIG. 8;
FIG. 11 is a toe side elevational view of FIG. 8;
FIG. 12 is a rear elevational view of FIG. 8;
FIG. 13 is a heel side elevational view of FIG. 8; and,
FIG. 14 is a bottom elevational view of FIG. 8.

1 Claim, 8 Drawing Sheets

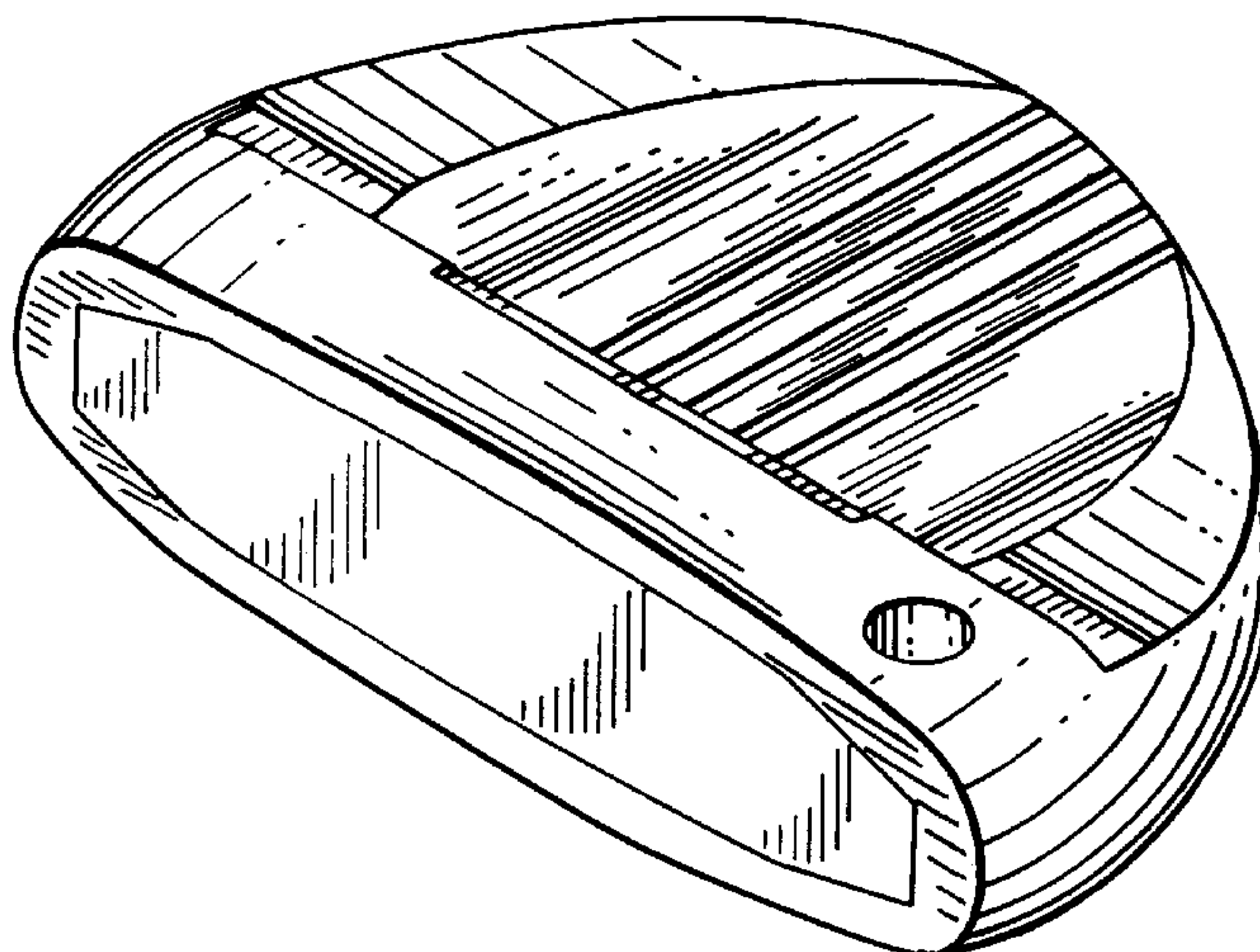

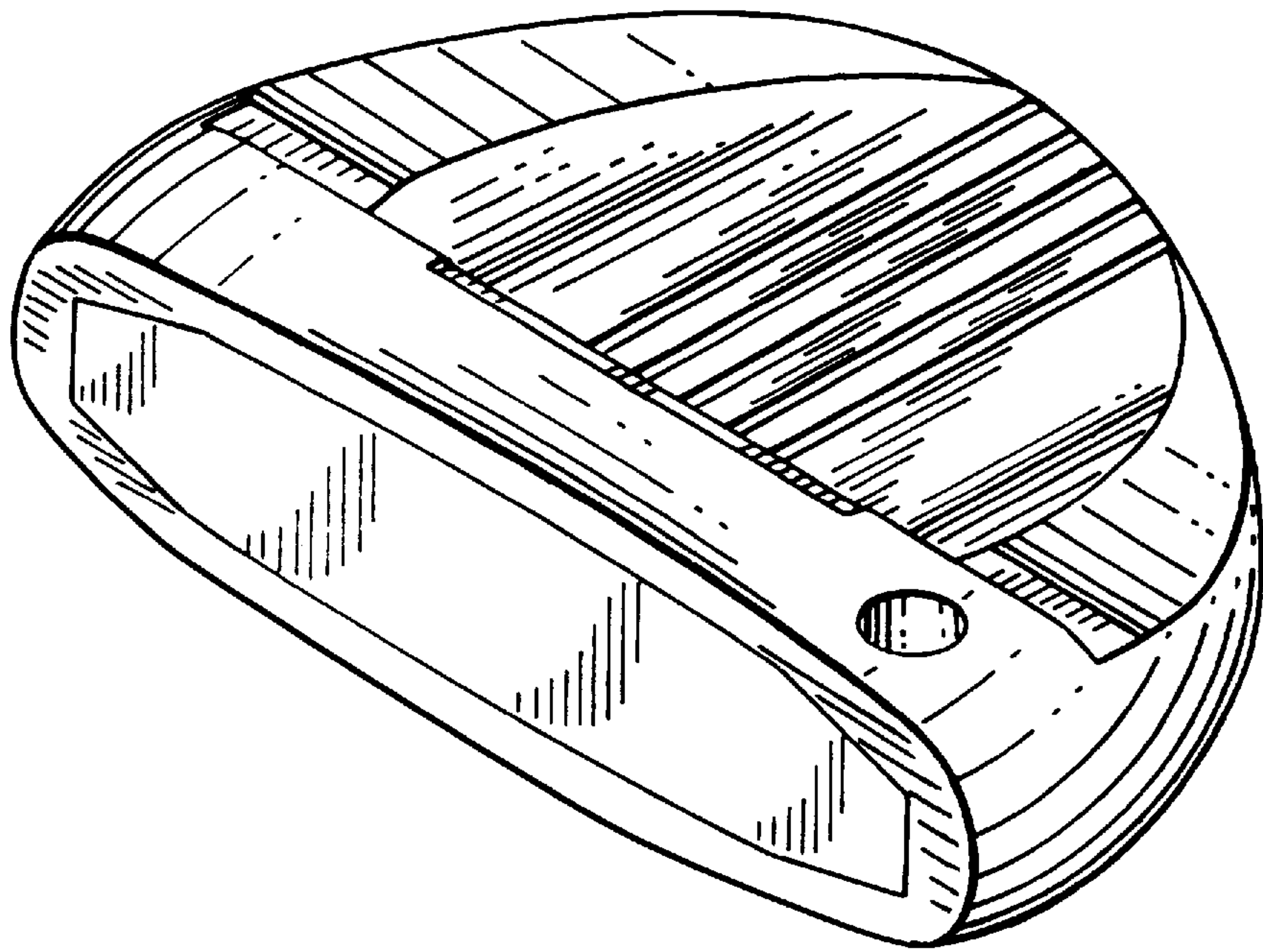

FIG. 1

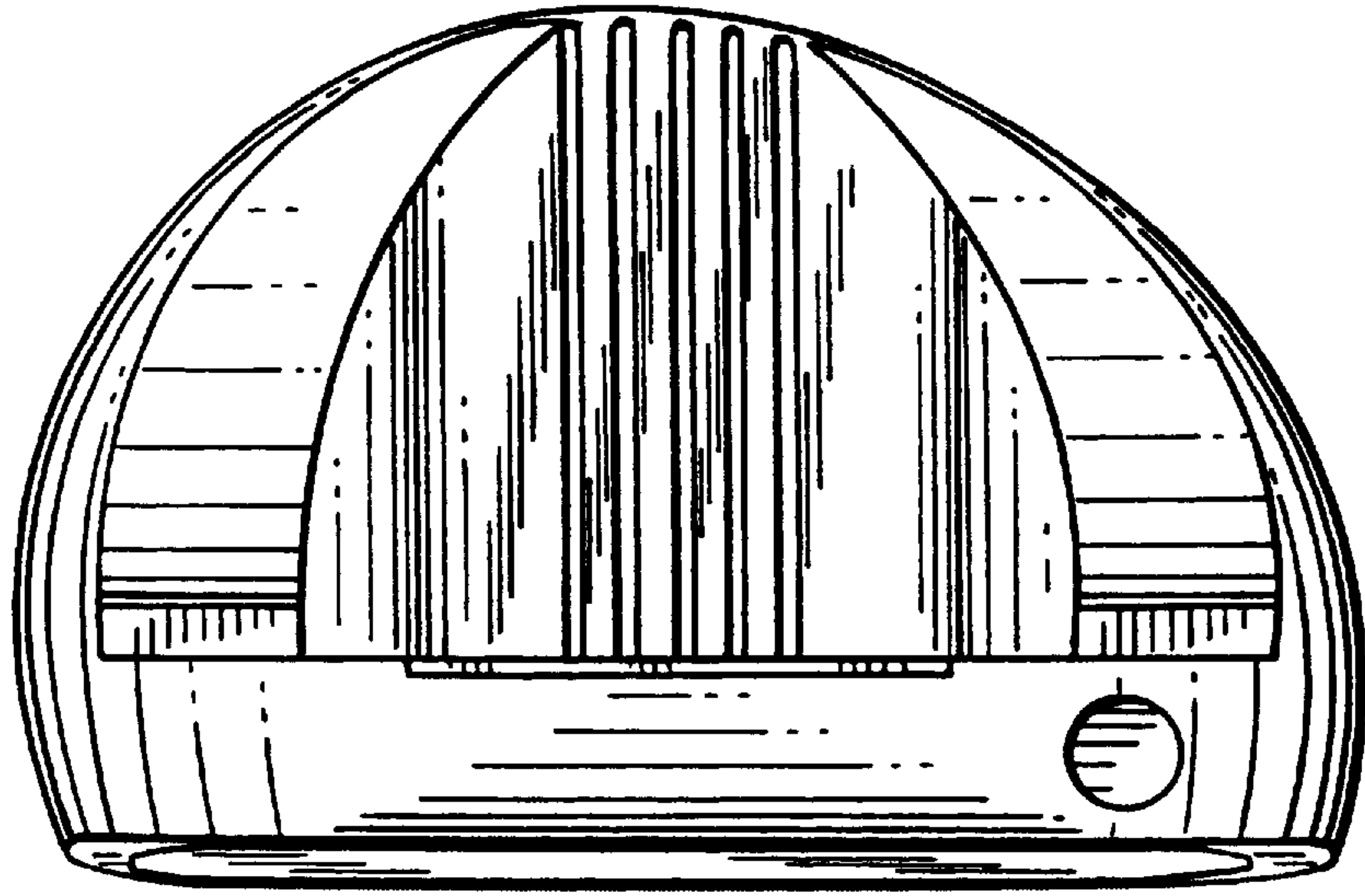

FIG. 2

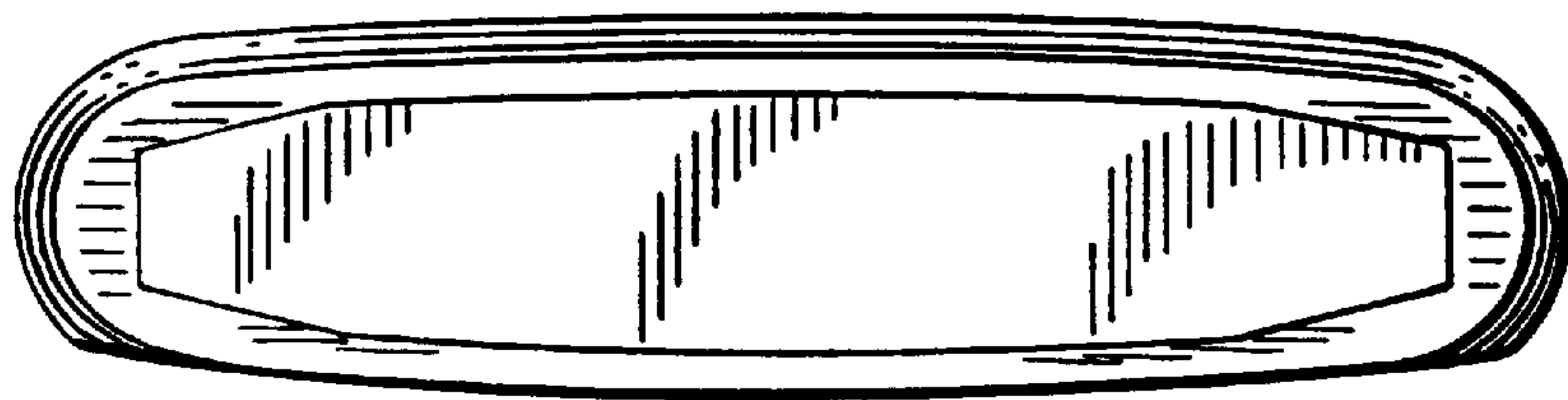

FIG. 3



FIG. 4

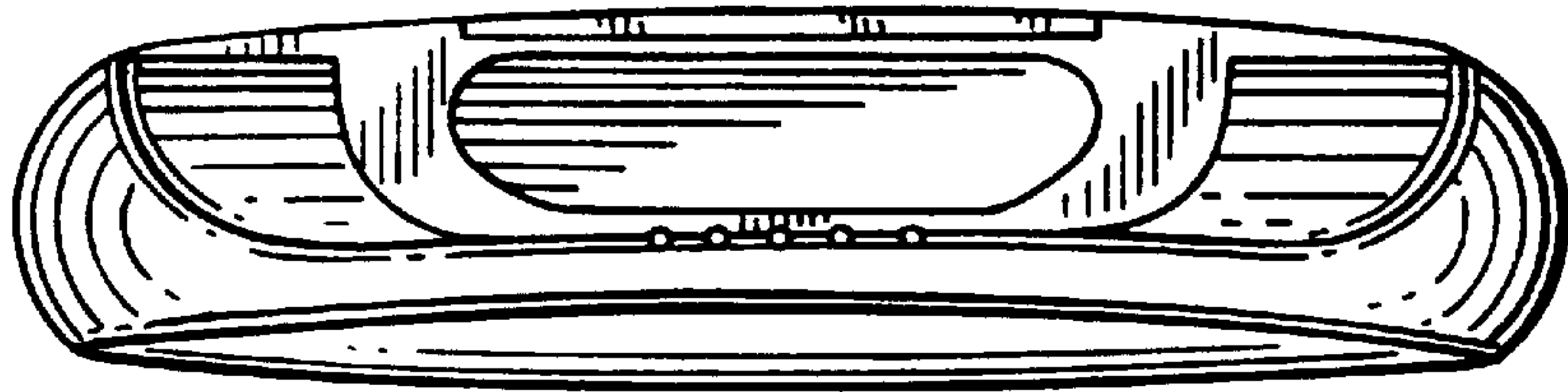

FIG. 5

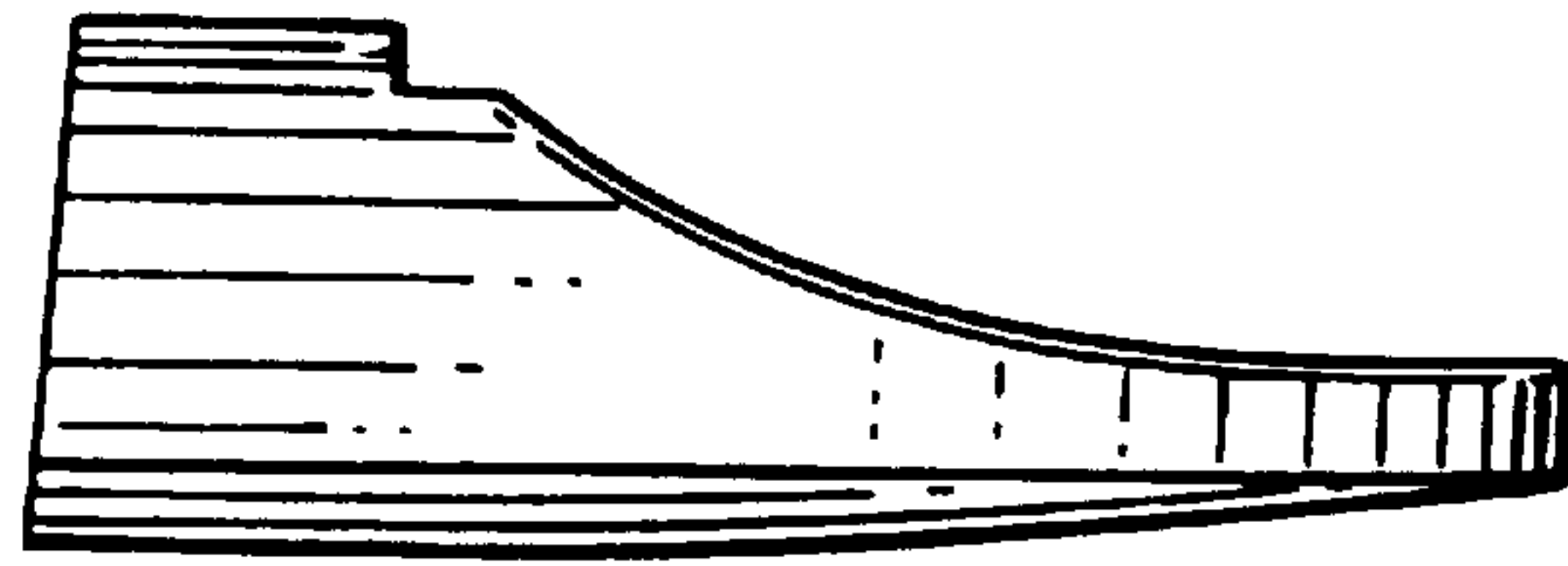

FIG. 6

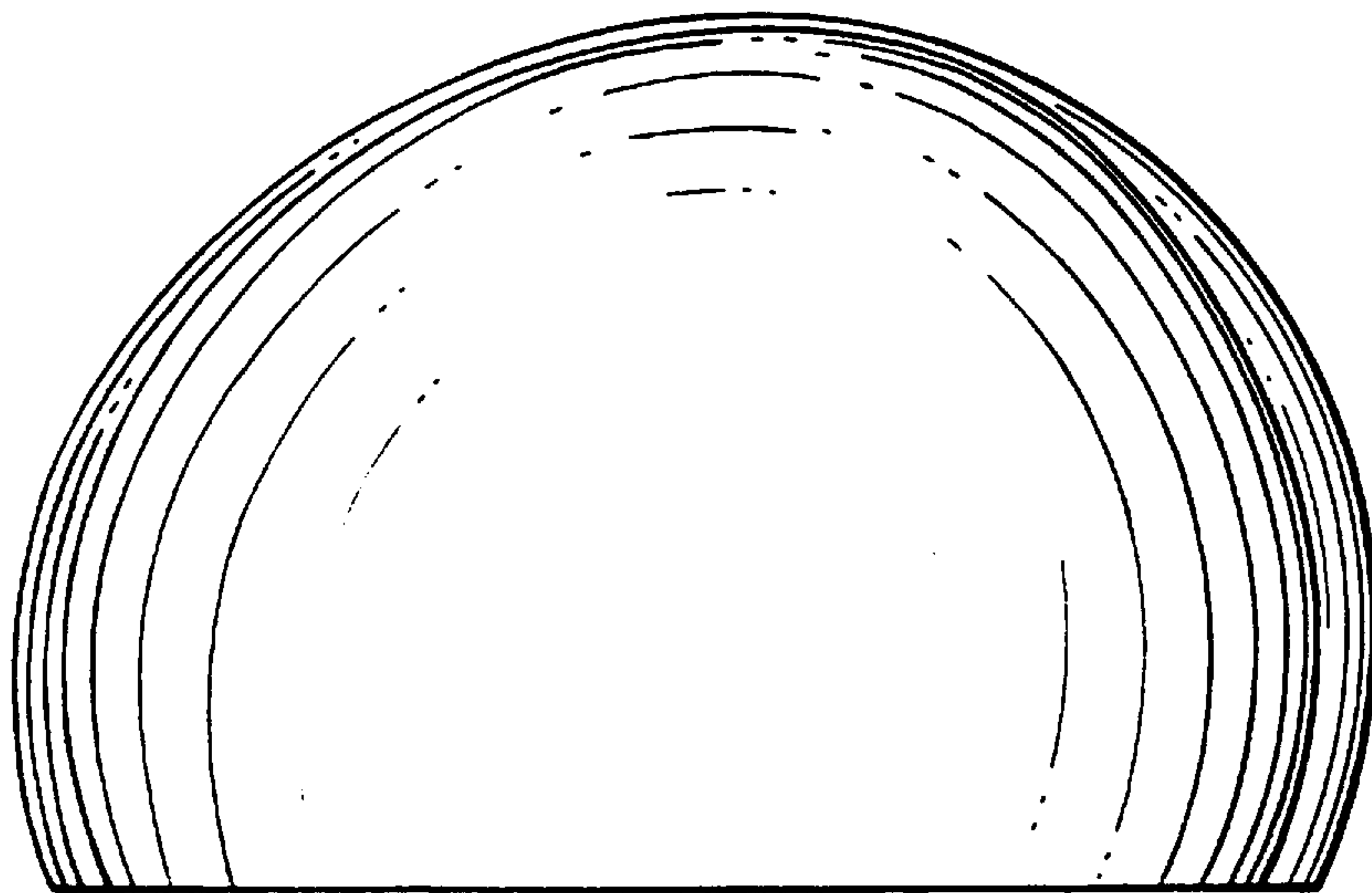

FIG. 7

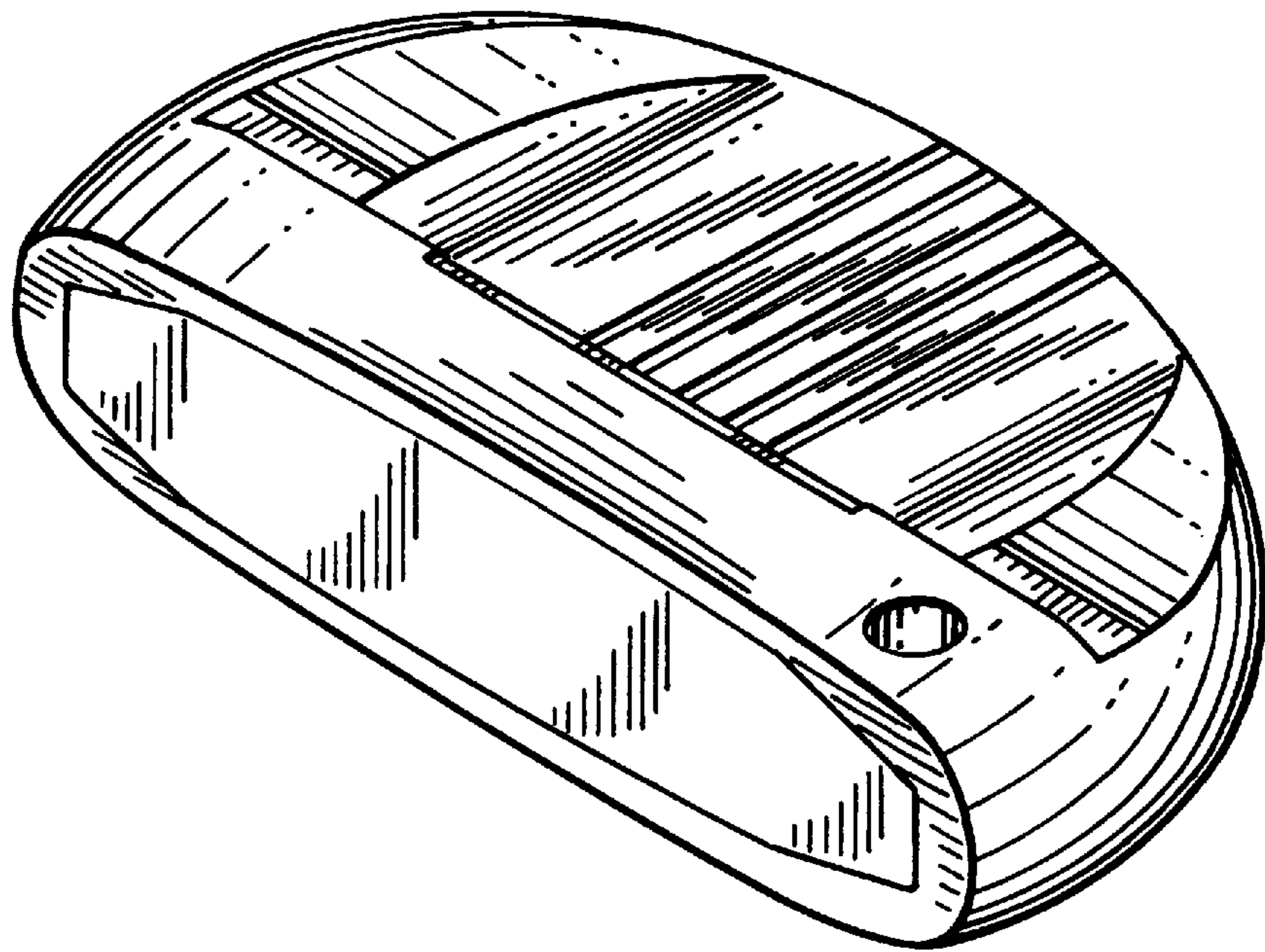

FIG. 8

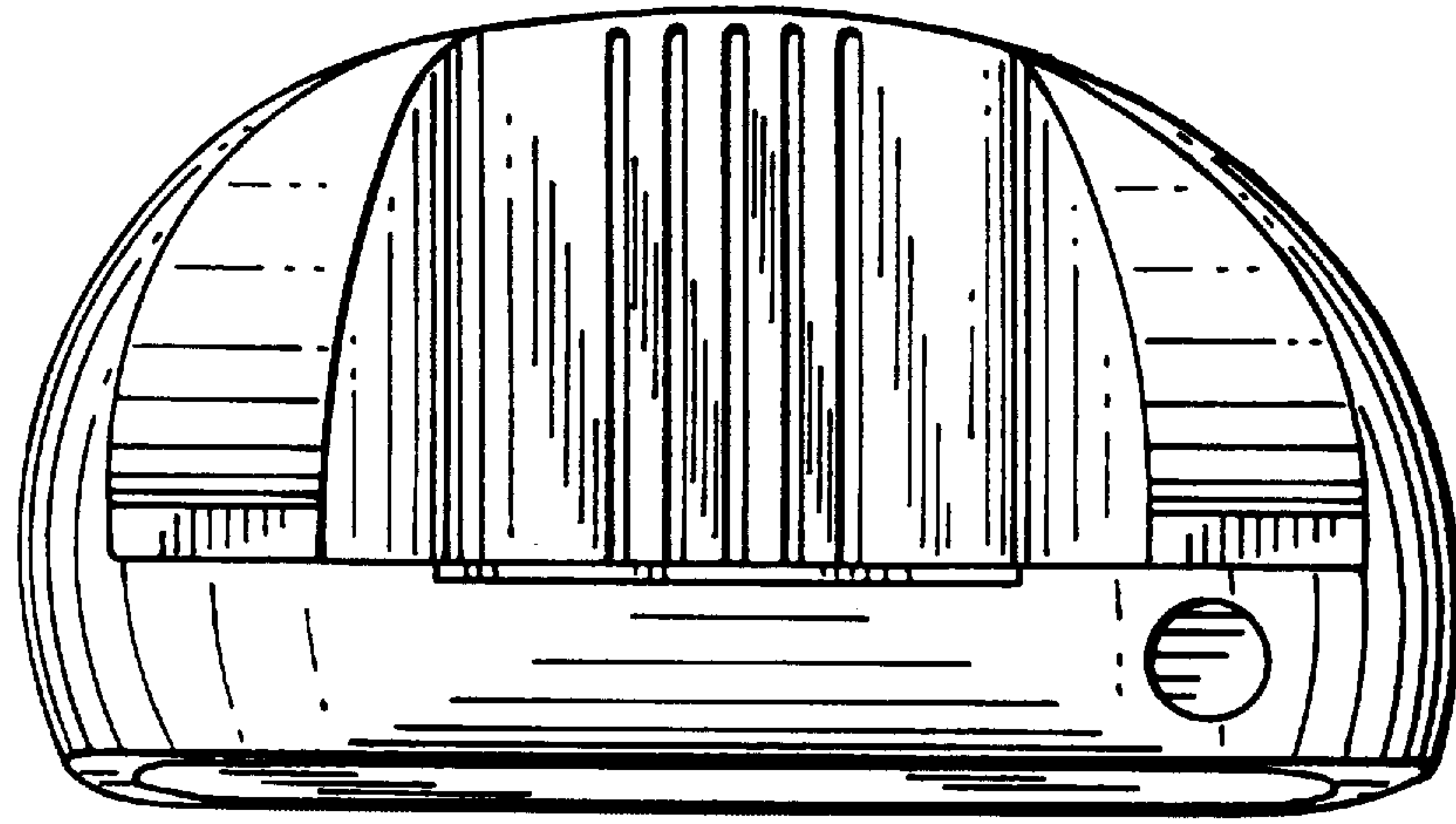

FIG. 9

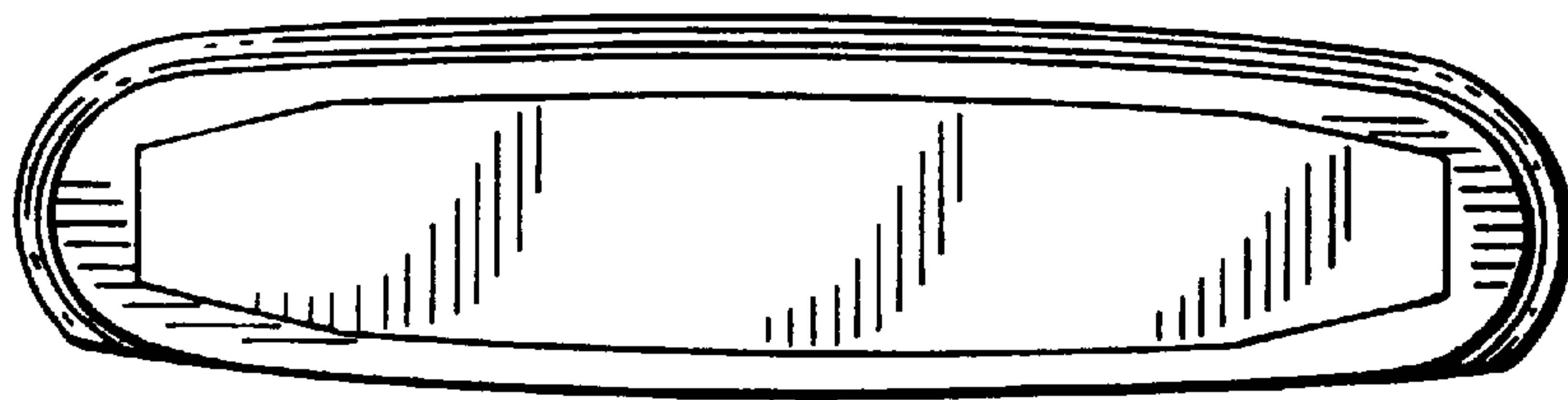

FIG. 10

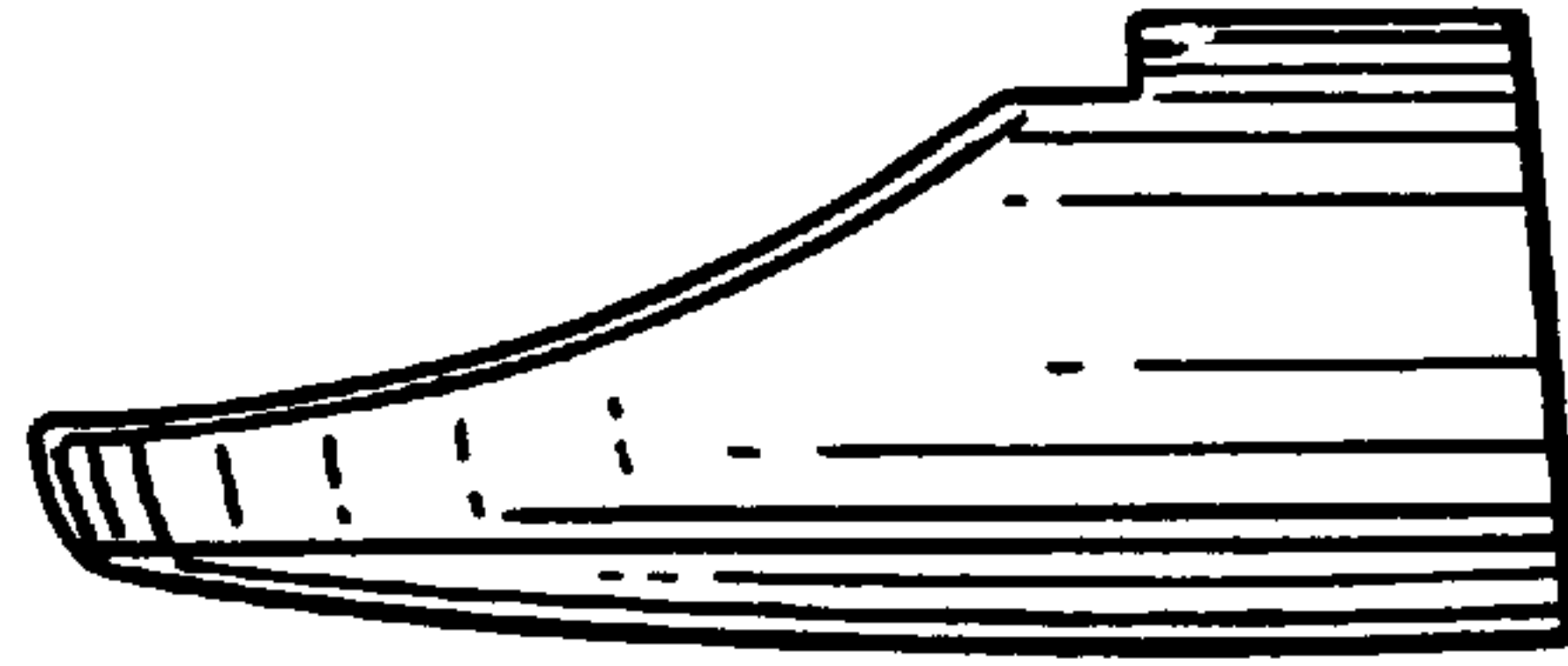

FIG. 11

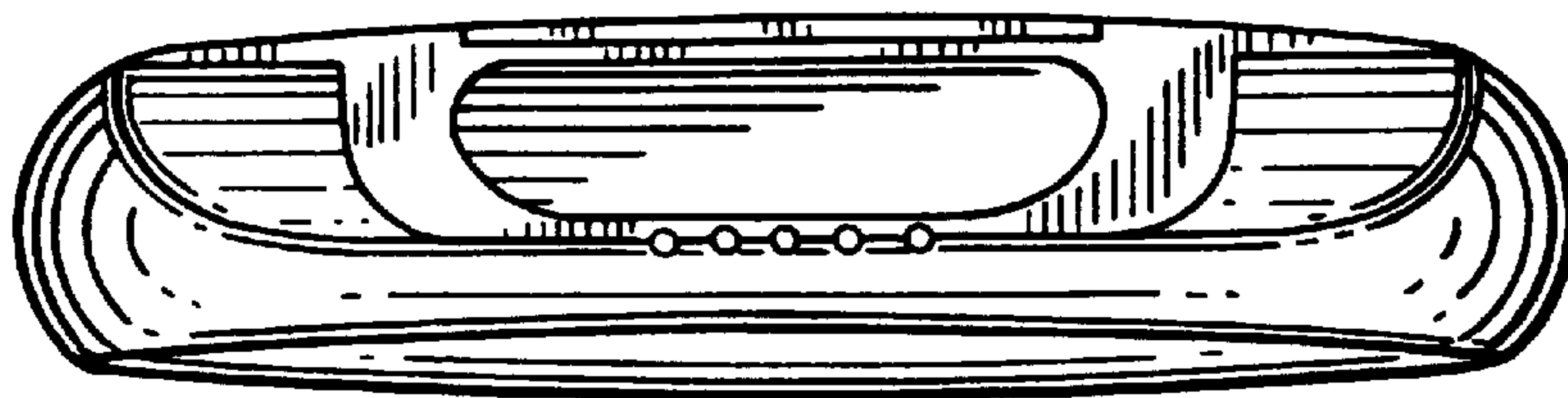

FIG. 12

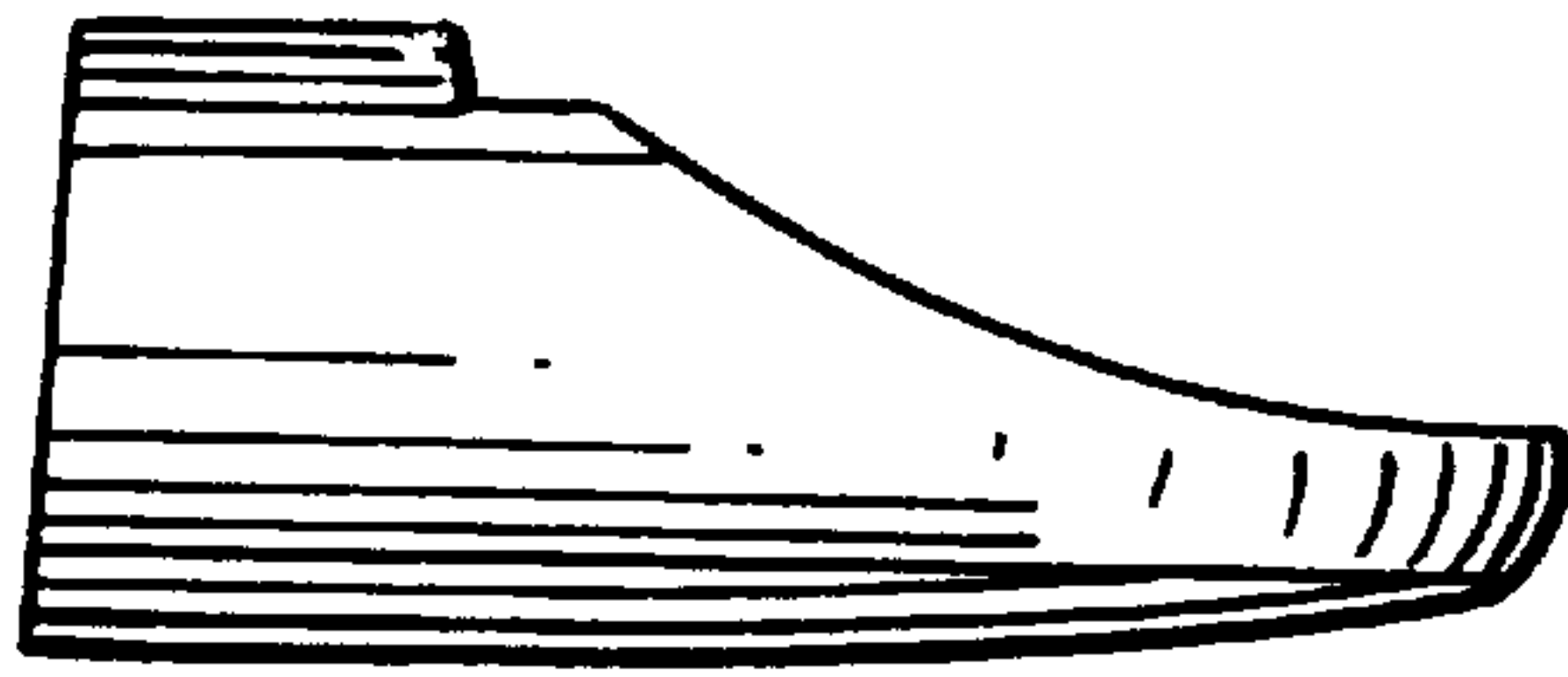

FIG. 13

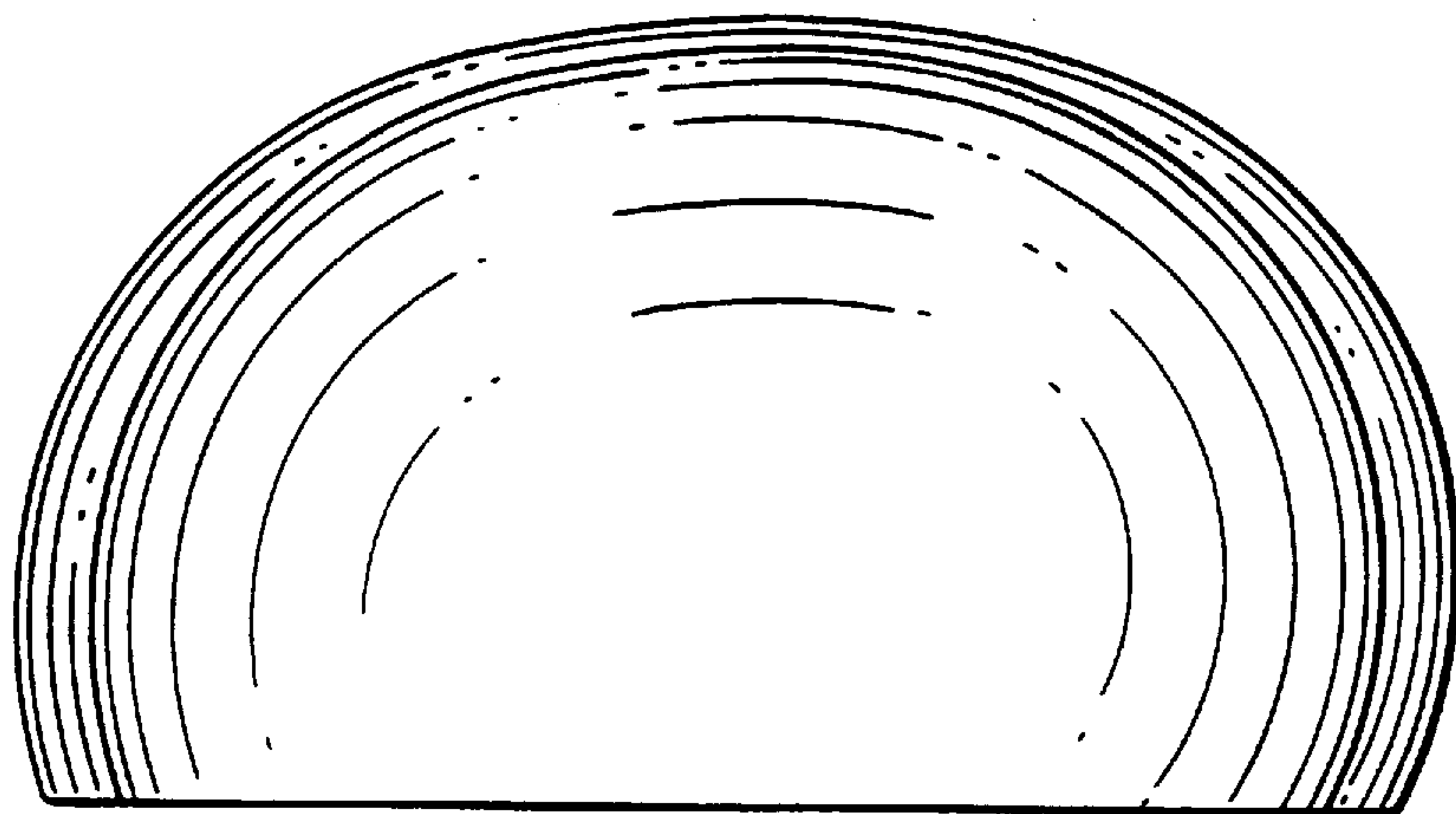

FIG. 14