



US00D400574S

United States Patent [19]

[11] **Patent Number: Des. 400,574**

Inoue et al.

[45] **Date of Patent: ***Nov. 3, 1998**

[54] **INK TANK FOR PRINTER**

[75] Inventors: **Manabu Inoue**, Yokohama; **Hajime Kishida**, Tokyo; **Osamu Sato**, Chigasaki, all of Japan

[73] Assignee: **Canon Kabushiki Kaisha**, Tokyo, Japan

[*] Notice: The term of this patent shall not extend beyond the expiration date of Pat. No. Des. 392,312.

[**] Term: **14 Years**

[21] Appl. No.: **69,119**

[22] Filed: **Apr. 11, 1997**

[30] **Foreign Application Priority Data**

Oct. 16, 1996 [JP] Japan 8-30932

[51] **LOC (6) Cl.** **18-02**

[52] **U.S. Cl.** **D18/56; 347/86**

[58] **Field of Search** **D18/56; 347/86, 347/87**

[56] **References Cited**

U.S. PATENT DOCUMENTS

D. 356,110	3/1995	Tokuda et al.	D18/56
D. 359,755	6/1995	Tokuda et al.	D18/56
D. 367,884	3/1996	Taneya et al.	D18/56
D. 371,803	7/1996	Kawashima et al.	347/86
D. 380,490	7/1997	Tashiro et al.	D18/56

D. 381,039	7/1997	Shinada et al.	347/86
4,998,115	3/1991	Nevarez et al.	347/87
5,278,584	1/1994	Keefe et a.	347/87
5,408,256	4/1995	Keen et al.	347/87
5,477,255	12/1995	Juth	347/87

FOREIGN PATENT DOCUMENTS

523635	1/1993	European Pat. Off.	347/87
635373	1/1995	European Pat. Off.	347/86
639461	2/1995	European Pat. Off.	347/86
003446182	7/1985	Germany	347/87
360192639	10/1985	Japan	347/87
362231759	10/1987	Japan	347/87
363239062	10/1988	Japan	347/87
406115093	4/1994	Japan	347/87

Primary Examiner—Cathy Anne MacCormac
Attorney, Agent, or Firm—Fitzpatrick, Cella, Harper & Scinto

[57] **CLAIM**

The ornamental design for an ink tank for printer, as shown and described.

DESCRIPTION

FIG. 1 is a front view of an ink tank for printer showing our new design;
FIG. 2 is a rear view thereof;
FIG. 3 is a top plan view thereof;
FIG. 4 is a bottom plan view thereof;
FIG. 5 is a left side view thereof;
FIG. 6 is a right side view thereof; and,
FIG. 7 is a perspective view thereof;

1 Claim, 3 Drawing Sheets

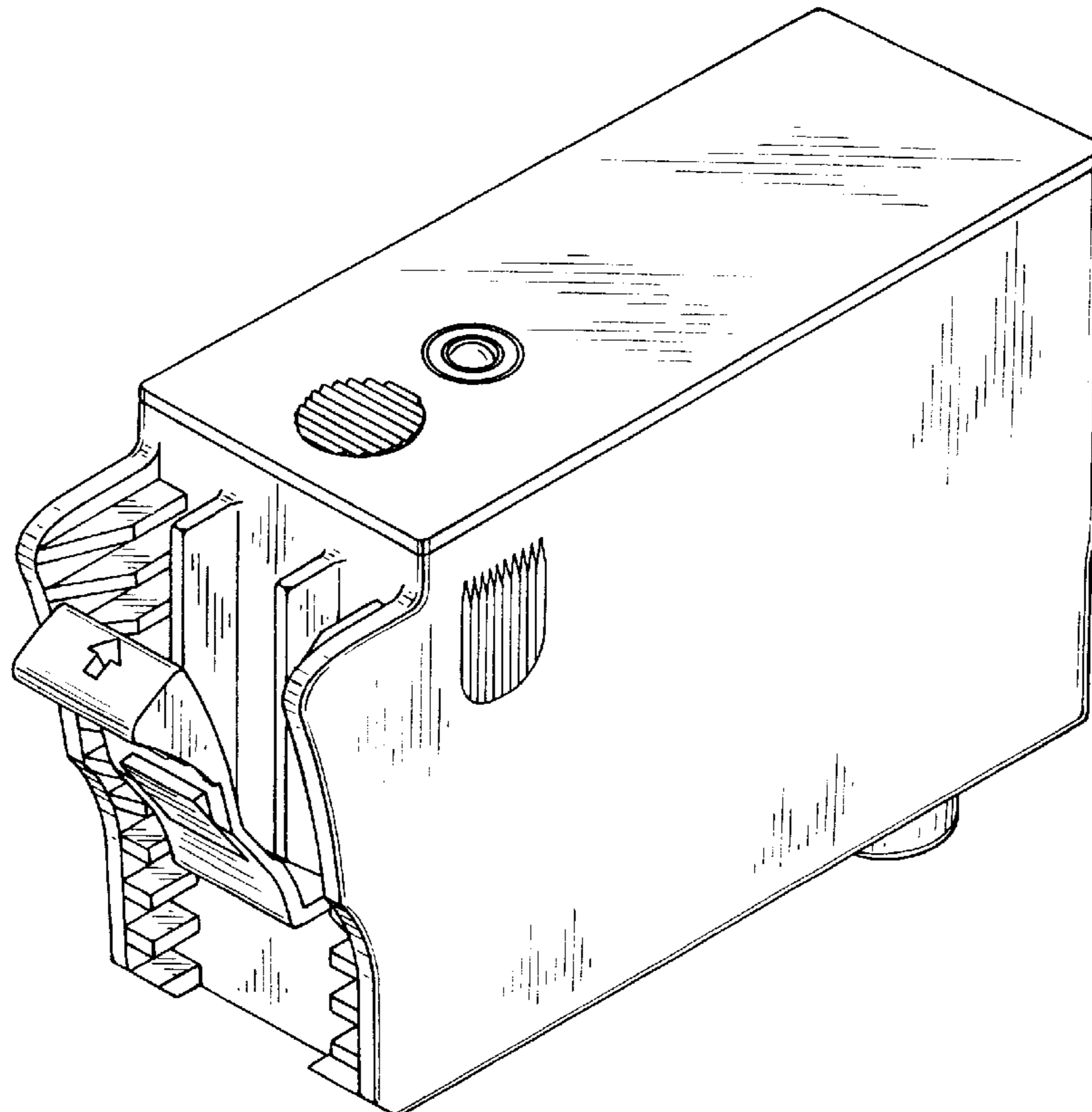

FIG. 1

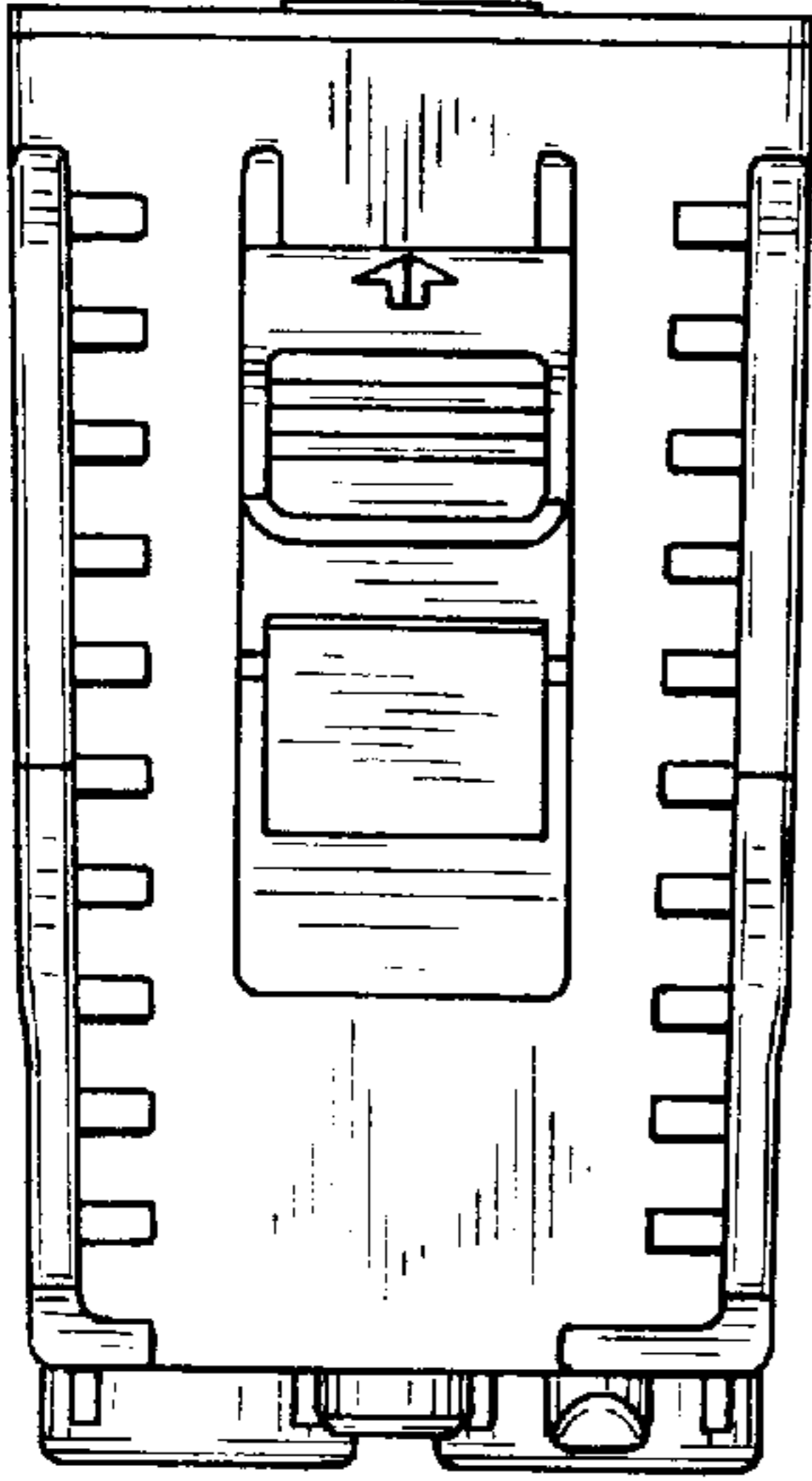

FIG. 3

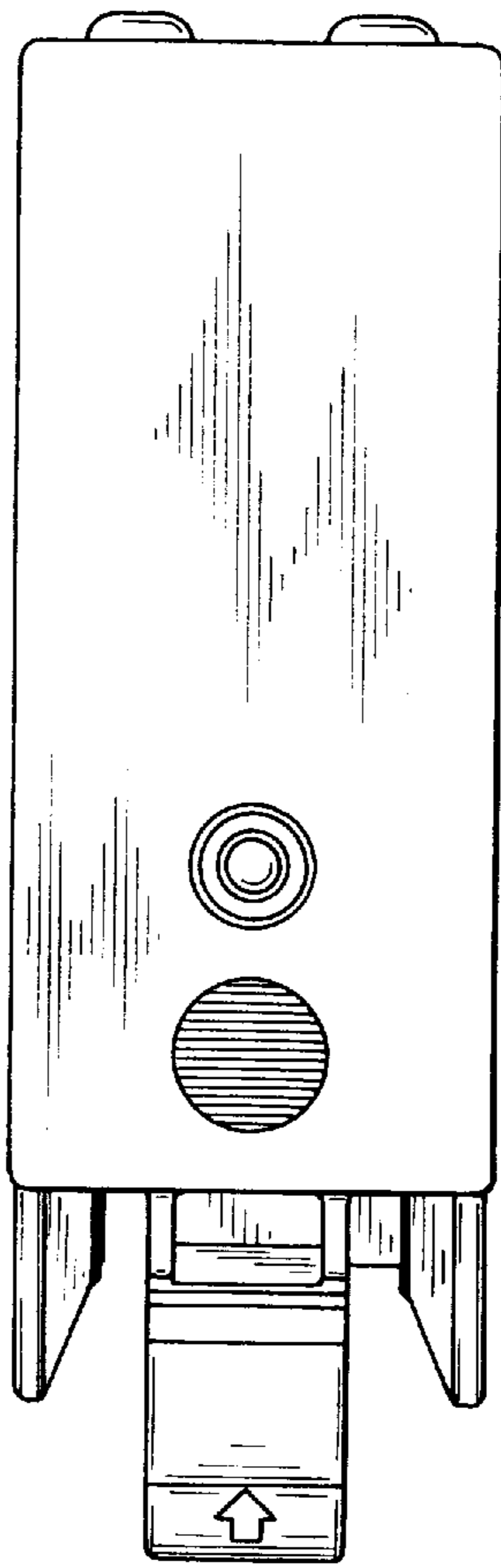

FIG. 4

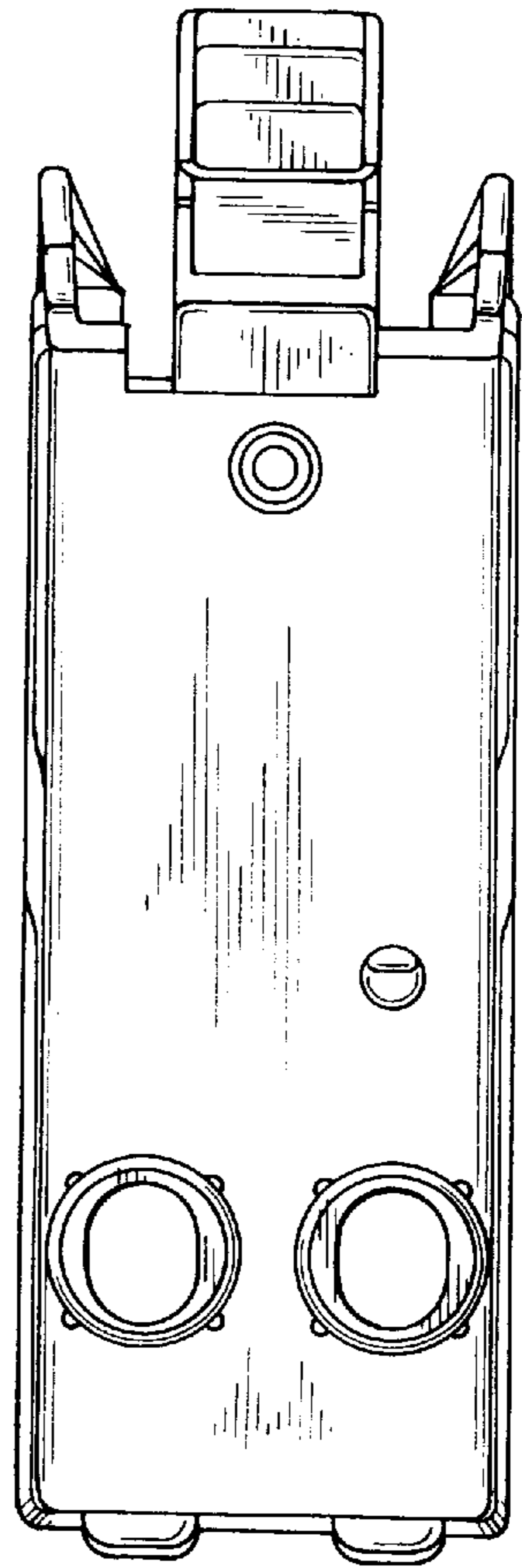

FIG. 2

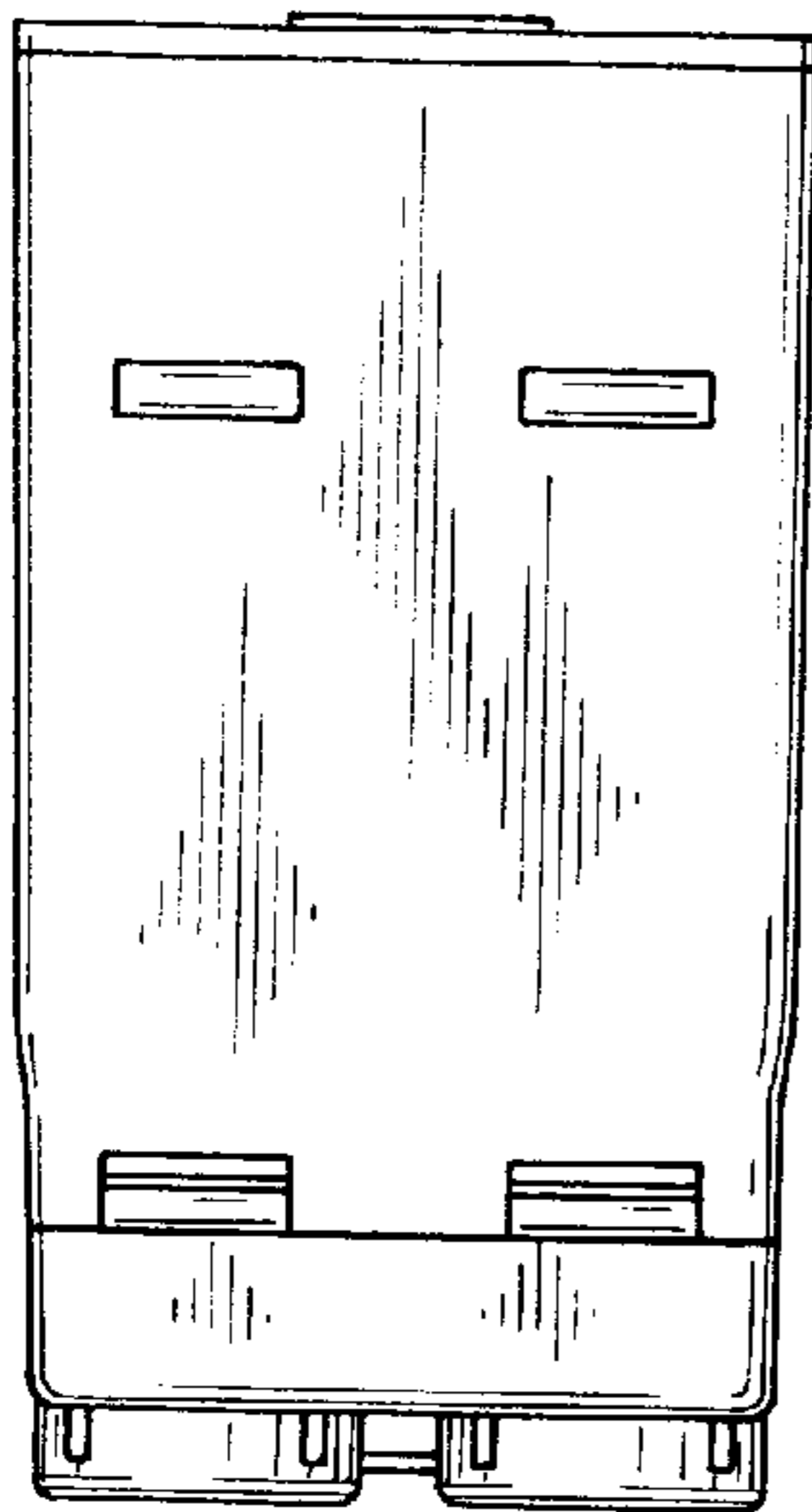

FIG. 5

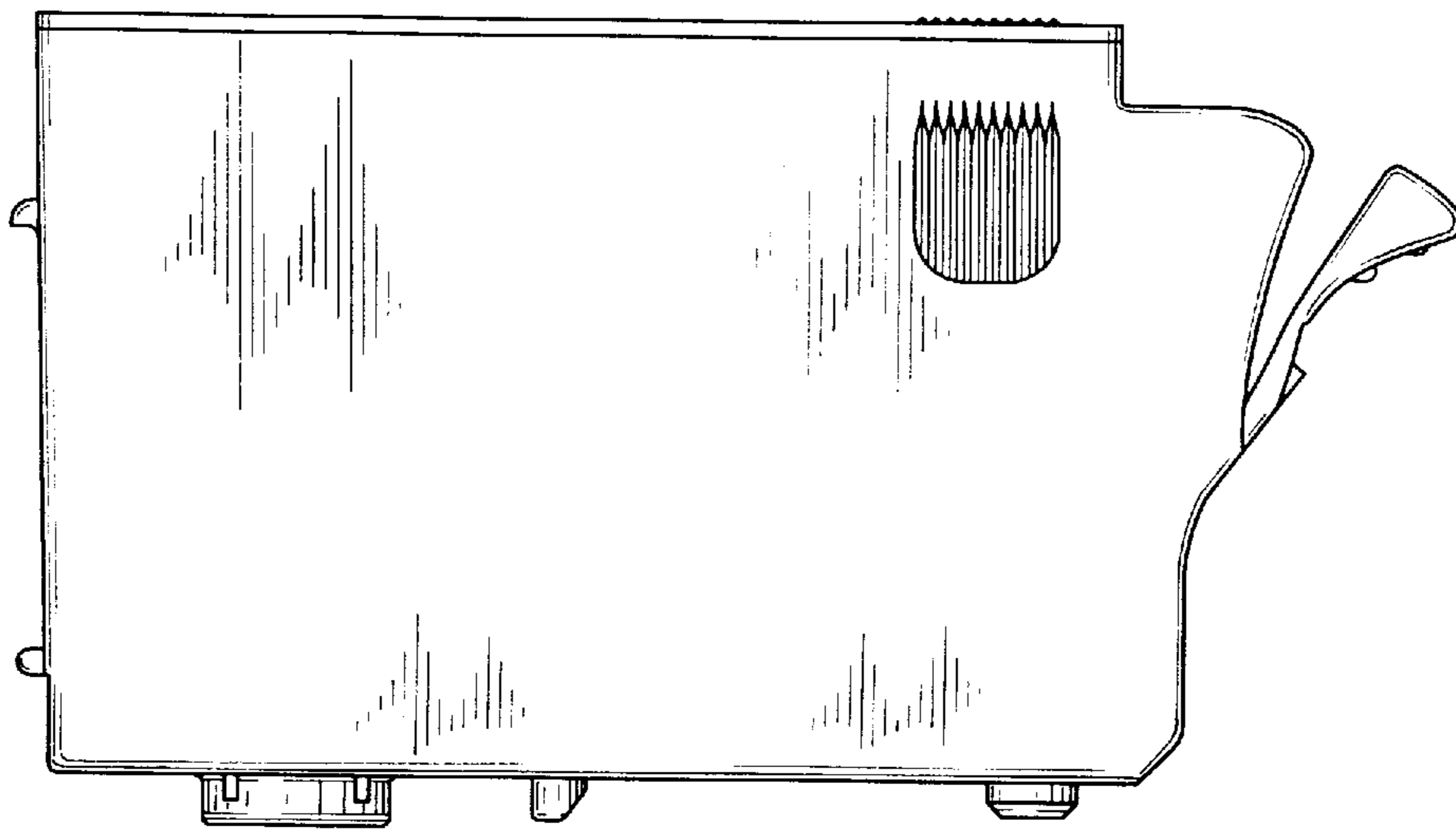

FIG. 6

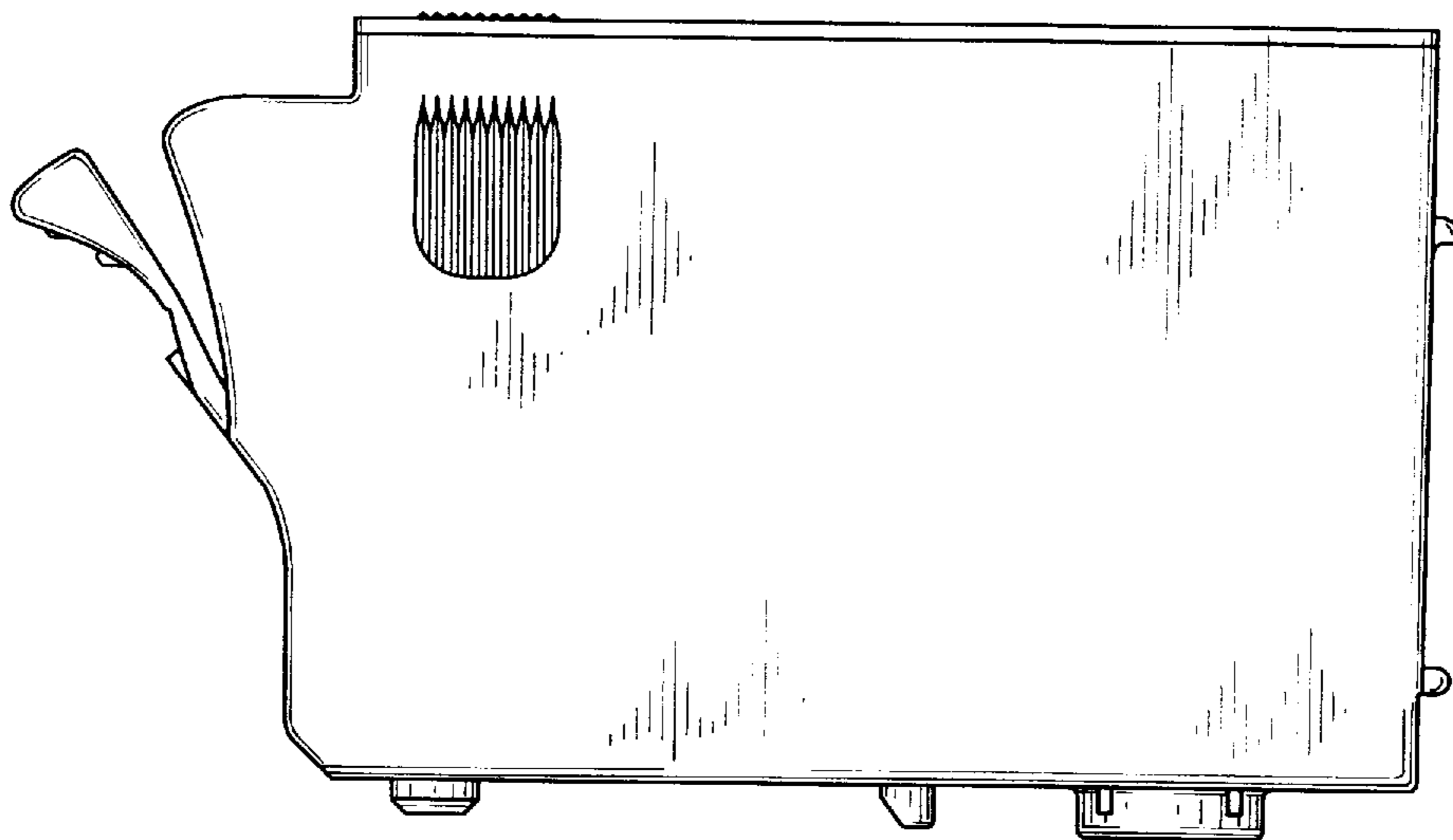

FIG. 7

