



US00D400572S

United States Patent [19]

Sekine et al.

[11] Patent Number: **Des. 400,572**

[45] Date of Patent: ****Nov. 3, 1998**

[54] **COMPUTER PRINTER**

[75] Inventors: **Tetsuya Sekine**, Yokohama; **Naoki Tashiro**, Kawasaki, both of Japan

[73] Assignee: **Canon Kabushiki Kaisha**, Tokyo, Japan

[**] Term: **14 Years**

[21] Appl. No.: **75,536**

[22] Filed: **Sep. 2, 1997**

[30] **Foreign Application Priority Data**

Mar. 7, 1997 [JP] Japan 9-6767

[51] **LOC (6) Cl.** **14-02**

[52] **U.S. Cl.** **D18/54; D18/55**

[58] **Field of Search** 400/613, 613.1-613.4, 400/690-694, 690.1-690.4; D18/50, 54, 55

[56] **References Cited**

U.S. PATENT DOCUMENTS

- D. 326,678 6/1992 Uchibori et al. D18/55
- D. 333,153 2/1993 Uchibori et al. D18/55
- D. 356,818 3/1995 Sekine et al. D18/55
- D. 373,378 9/1996 Brown et al. D18/55

- D. 373,380 9/1996 Dwyer et al. D18/55
- D. 379,827 6/1997 Andre D18/54
- D. 382,583 8/1997 Takahaski et al. D18/55
- D. 390,257 2/1998 Dwyer et al. D18/55
- D. 390,258 2/1998 Kawahara et al. D18/55

OTHER PUBLICATIONS

Micro Center The Computer Department Store Catalog; p. 17, Canon BJC-600 BubbleJet Color Printer; 1994.

Primary Examiner—Cathy Anne MacCormac
Attorney, Agent, or Firm—Fitzpatrick, Cella, Harper & Scinto

[57] **CLAIM**

The ornamental design for a computer printer, as shown and described.

DESCRIPTION

FIG. 1 is a front view of a computer printer showing our new design;
FIG. 2 is a rear view thereof;
FIG. 3 is a top plan view thereof;
FIG. 4 is a bottom plan view thereof;
FIG. 5 is a left side view thereof;
FIG. 6 is a right side view thereof; and,
FIG. 7 is a perspective view thereof.

1 Claim, 5 Drawing Sheets

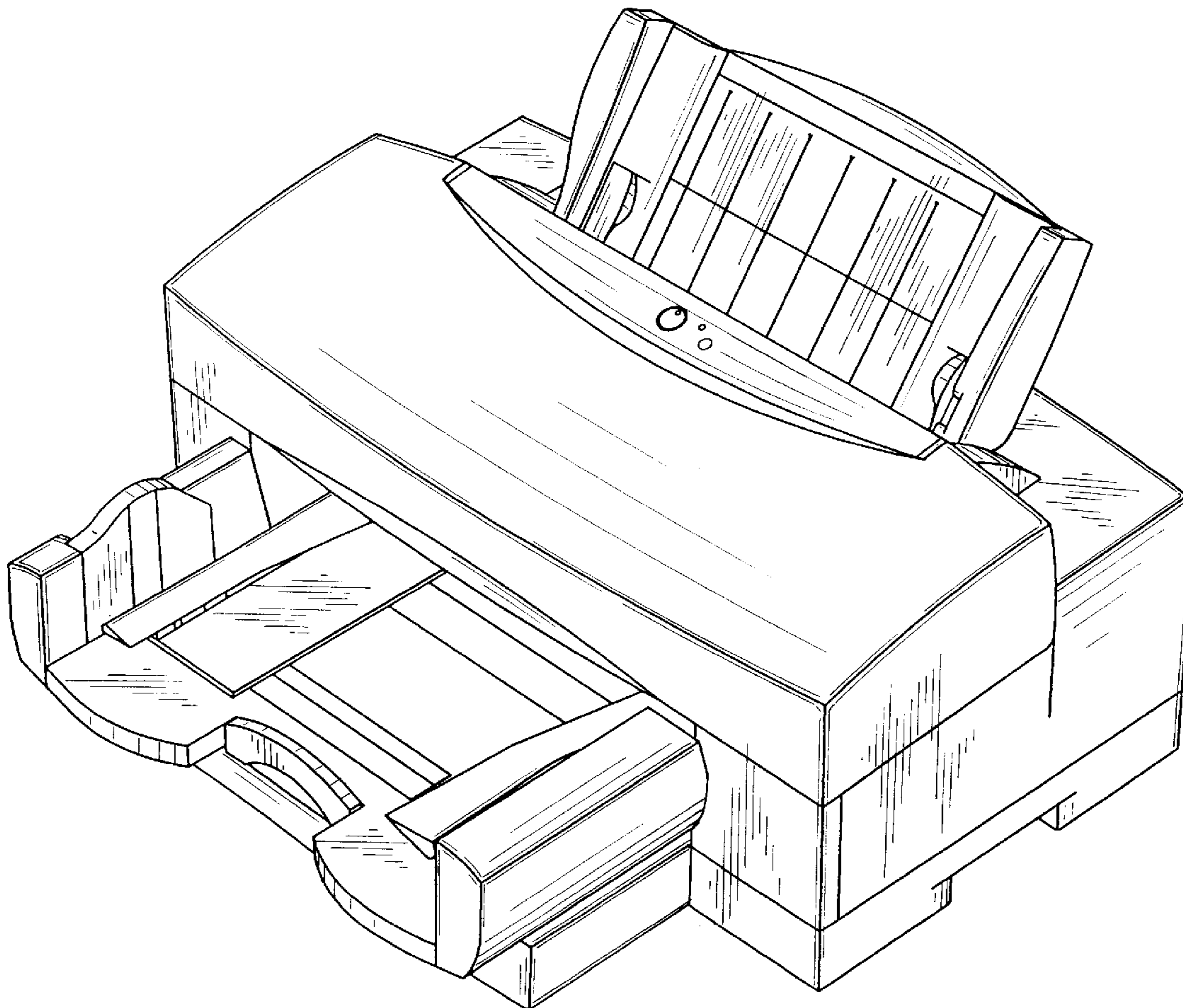

FIG. 1

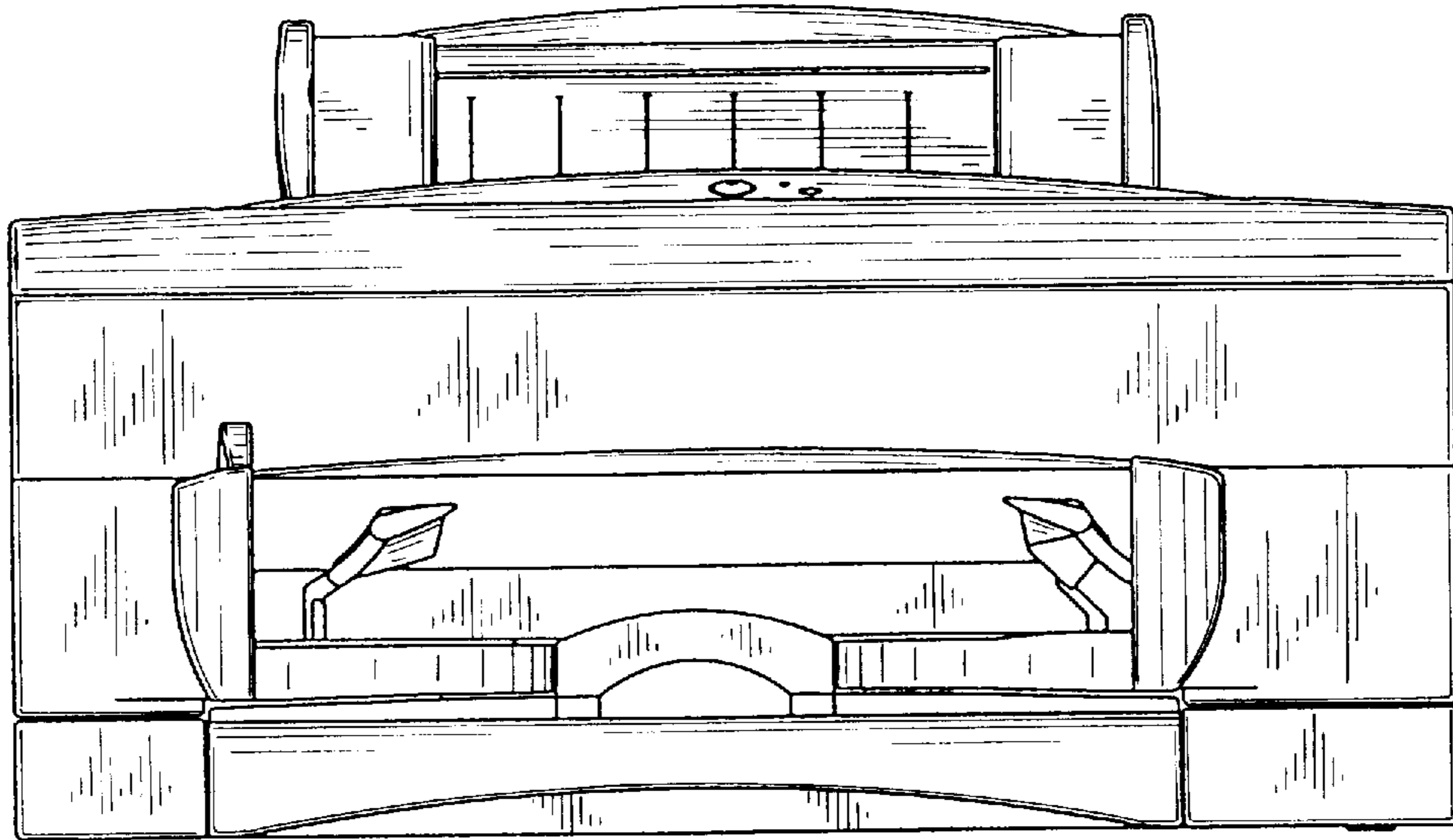

FIG. 2

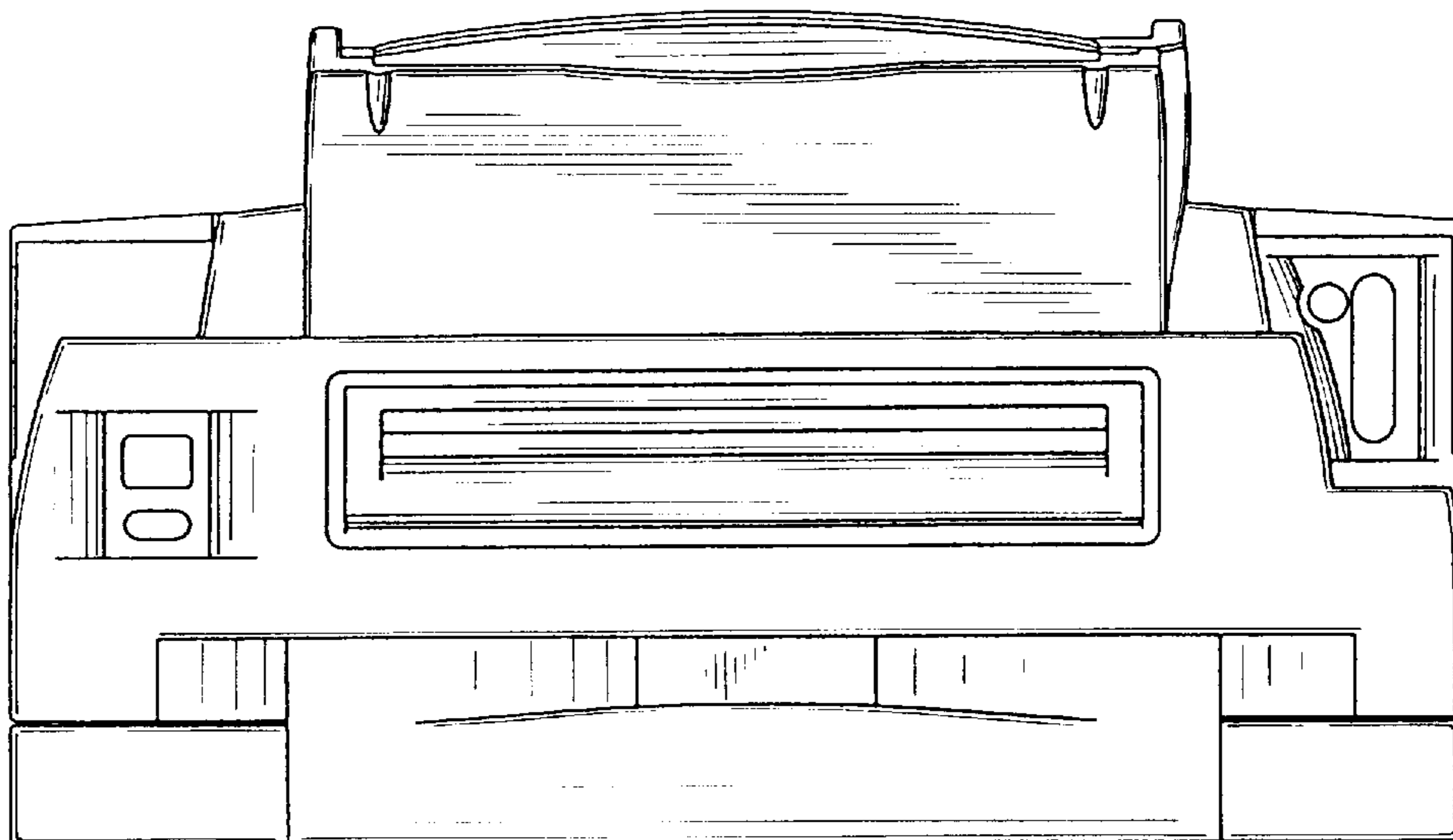

FIG. 3

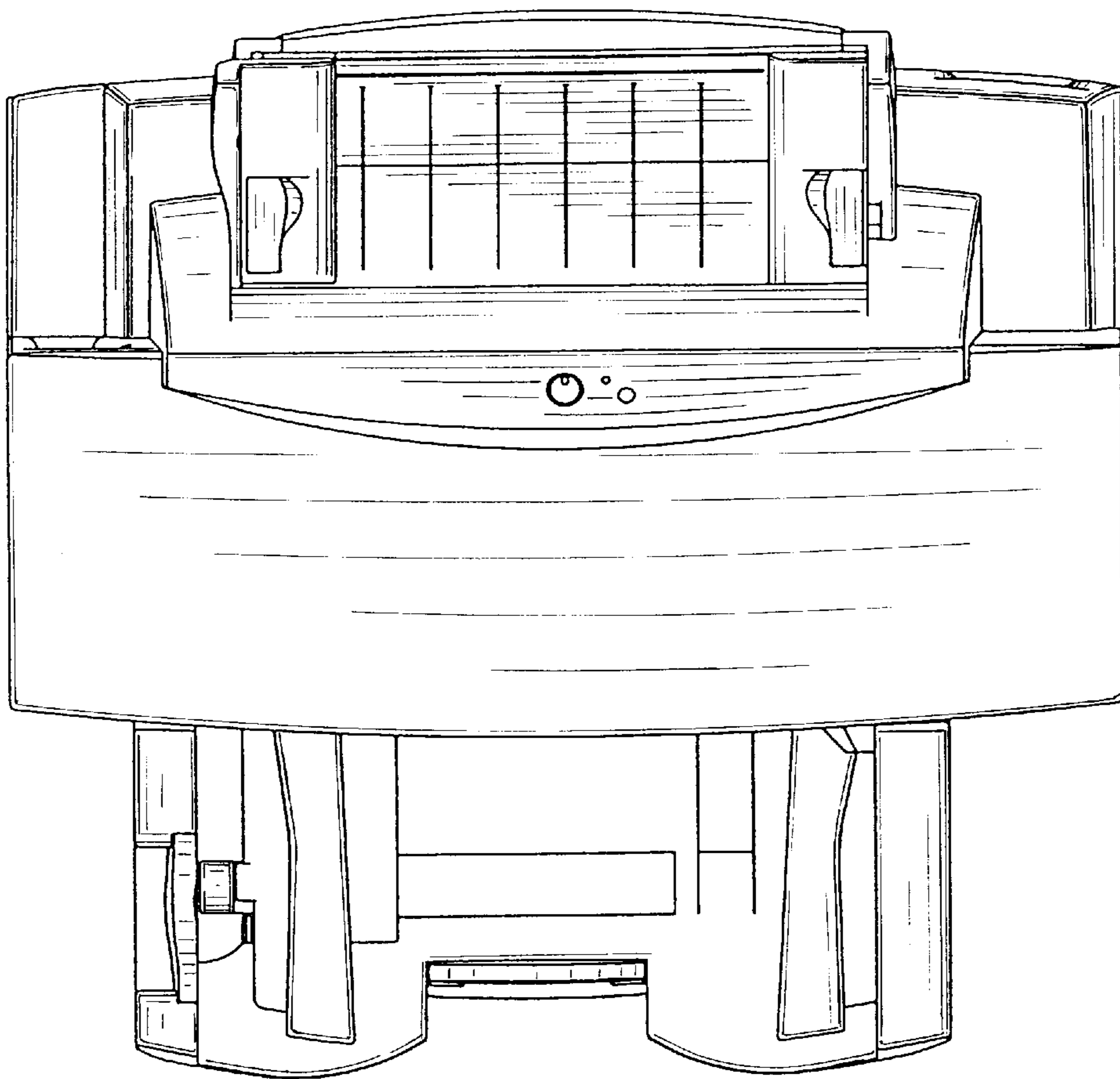

FIG. 4

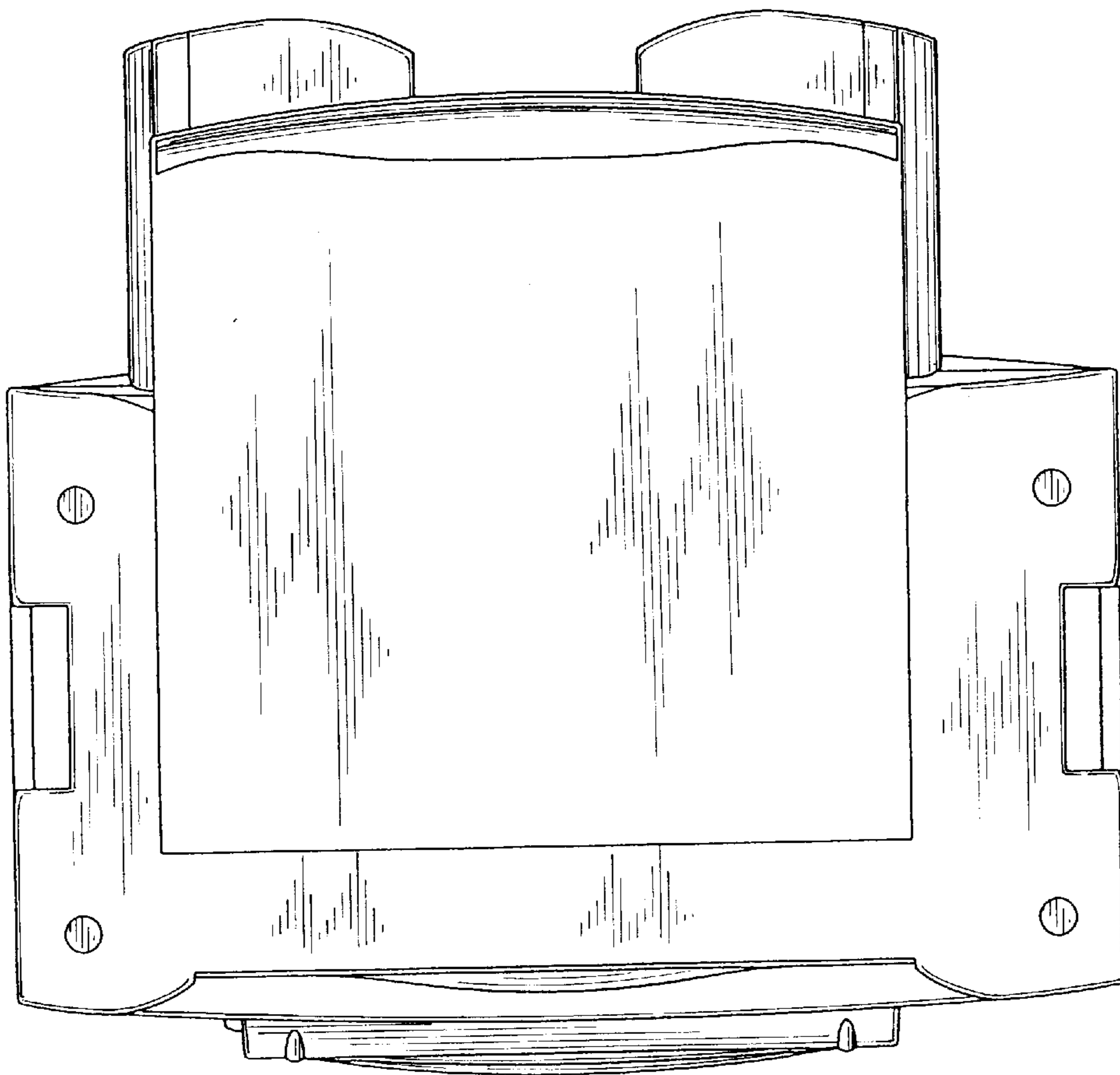

FIG. 5

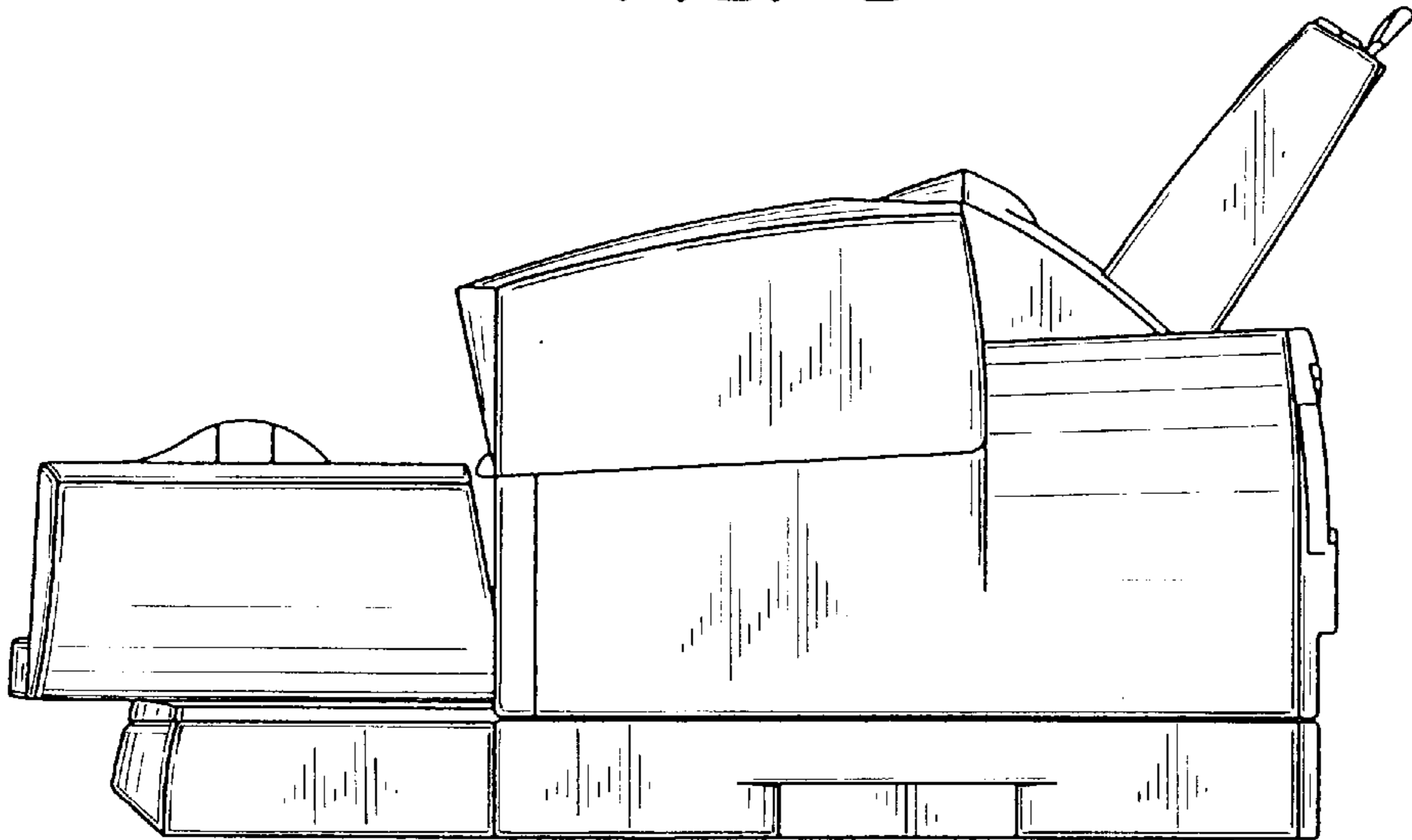

FIG. 6

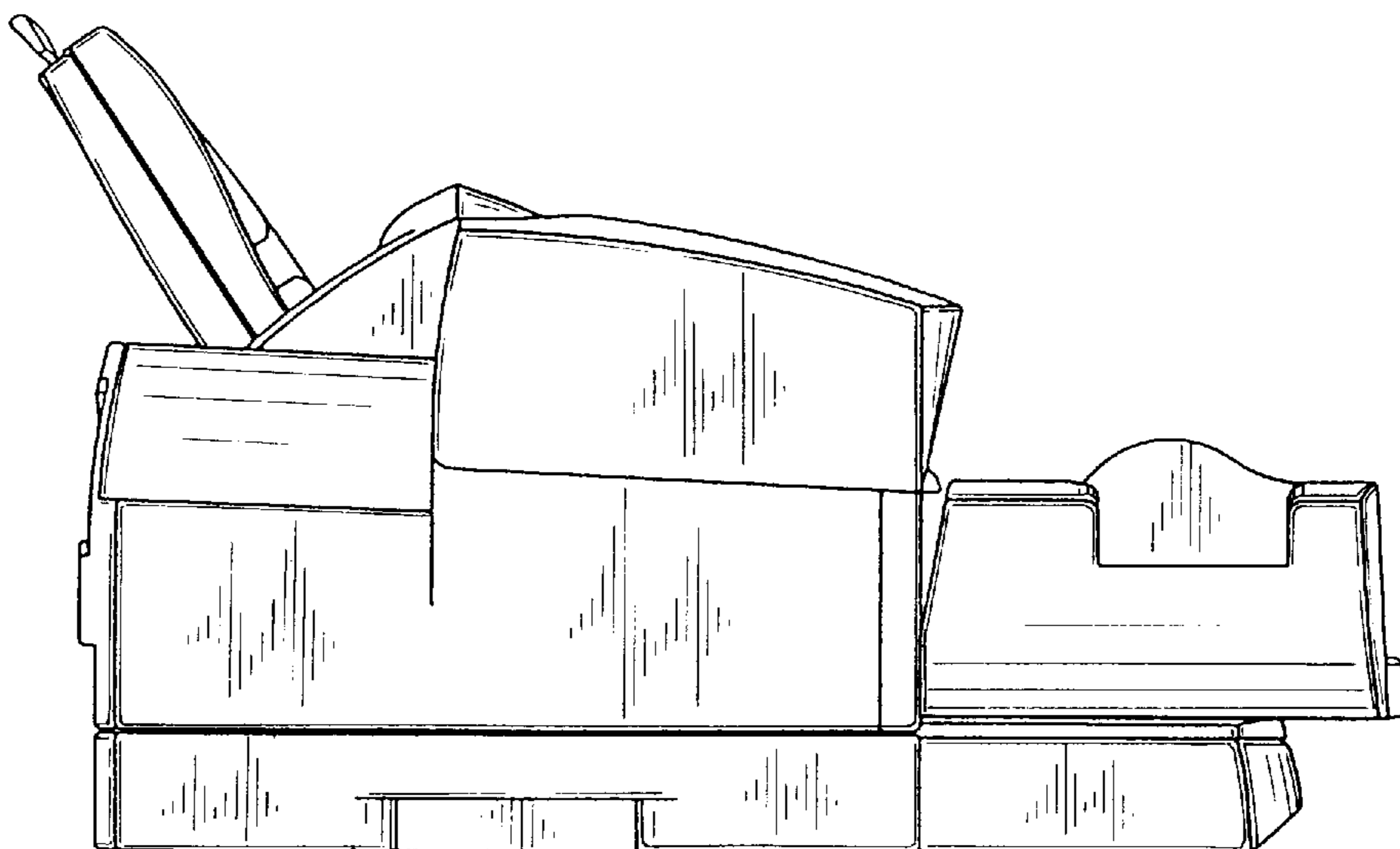

FIG. 7

