



US00D400551S

United States Patent [19] Pankhurst

[11] **Patent Number: Des. 400,551**

[45] **Date of Patent: **Nov. 3, 1998**

[54] **FOLDING PHOTOGRAPHIC APPARATUS**

[75] Inventor: **Paul Hayes Pankhurst**, London,
United Kingdom

[73] Assignee: **Polaroid Corporation**, Cambridge,
Mass.

[**] Term: **14 Years**

[21] Appl. No.: **63,521**

[22] Filed: **Dec. 10, 1996**

[51] **LOC (6) Cl.** **16-01**

[52] **U.S. Cl.** **D16/211**

[58] **Field of Search** D16/200-204,
D16/208, 209, 211, 212, 213, 216, 217,
218; 396/30-47, 348-350, 535-543

[56] **References Cited**

U.S. PATENT DOCUMENTS

D. 279,574	7/1985	Conner et al.	D16/211
D. 315,569	3/1991	Betts et al.	D16/211
D. 382,579	8/1997	Chueh	D16/211
D. 389,165	1/1998	Betts et al.	D16/211
4,389,110	6/1983	Pizzuti	396/178
4,723,140	2/1988	Whiteside et al.	396/39

Primary Examiner—Sandra L. Morris
Assistant Examiner—Adir Aronovich
Attorney, Agent, or Firm—Leslie Payne

[57] **CLAIM**

The ornamental design for a folding photographic apparatus, as shown and described.

DESCRIPTION

FIG. 1 is a left front perspective view of a folding photographic apparatus showing my design in its folded condition;

FIG. 2 is a folded front elevation view thereof;

FIG. 3 is a folded rear elevation view thereof;

FIG. 4 is a top plan elevation view thereof;

FIG. 5 is a bottom plan view thereof;

FIG. 6 is a right side elevational view thereof;

FIG. 7 is a left side elevational view thereof;

FIG. 8 is a left front perspective view thereof in an erect condition;

FIG. 9 is an erect front elevational view thereof;

FIG. 10 is an erect rear elevational view thereof;

FIG. 11 is a top plan view thereof;

FIG. 12 is a bottom plan view thereof;

FIG. 13 is an erect right side elevational view thereof; and,

FIG. 14 is an erect left side elevational view thereof.

1 Claim, 8 Drawing Sheets

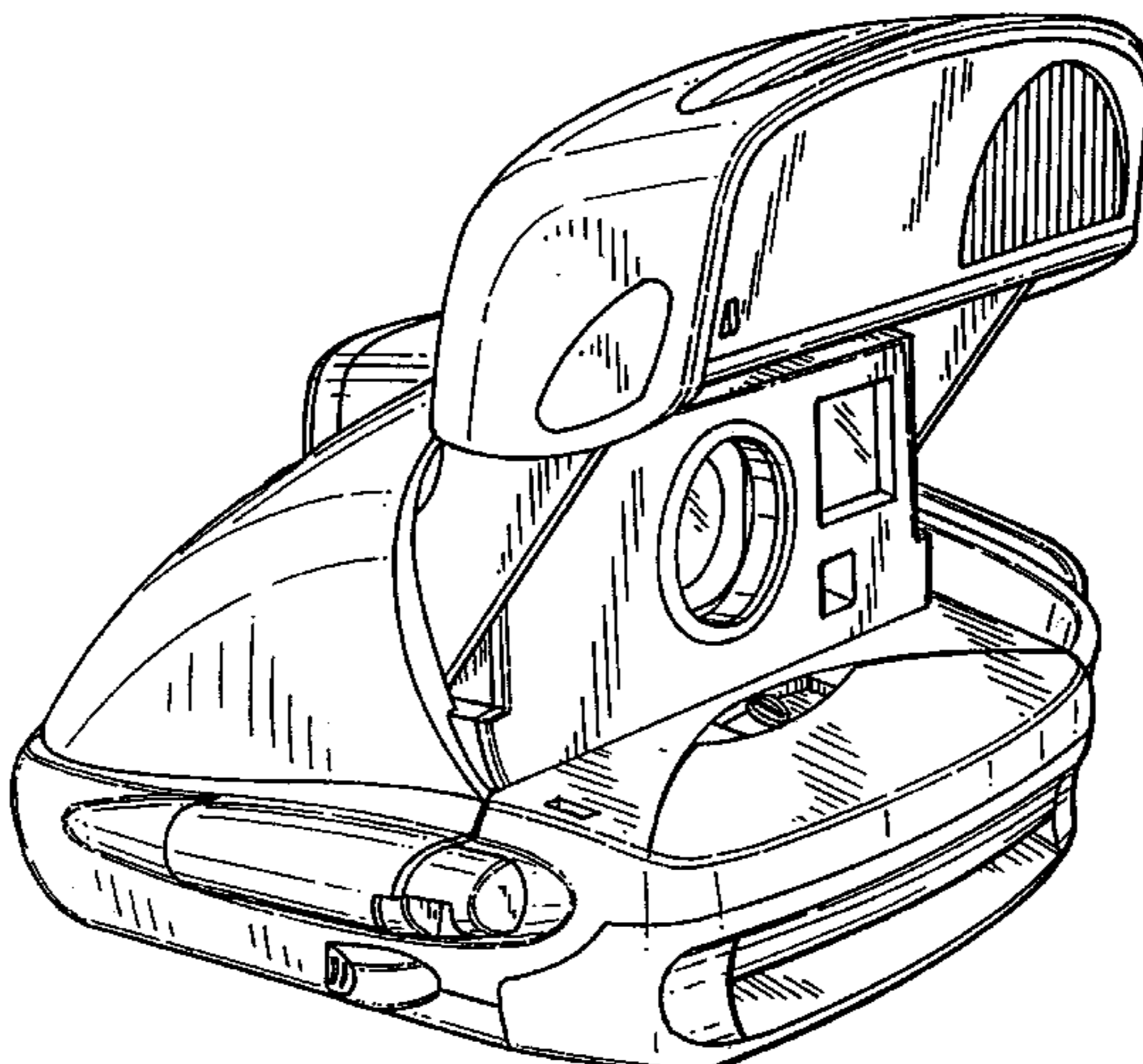
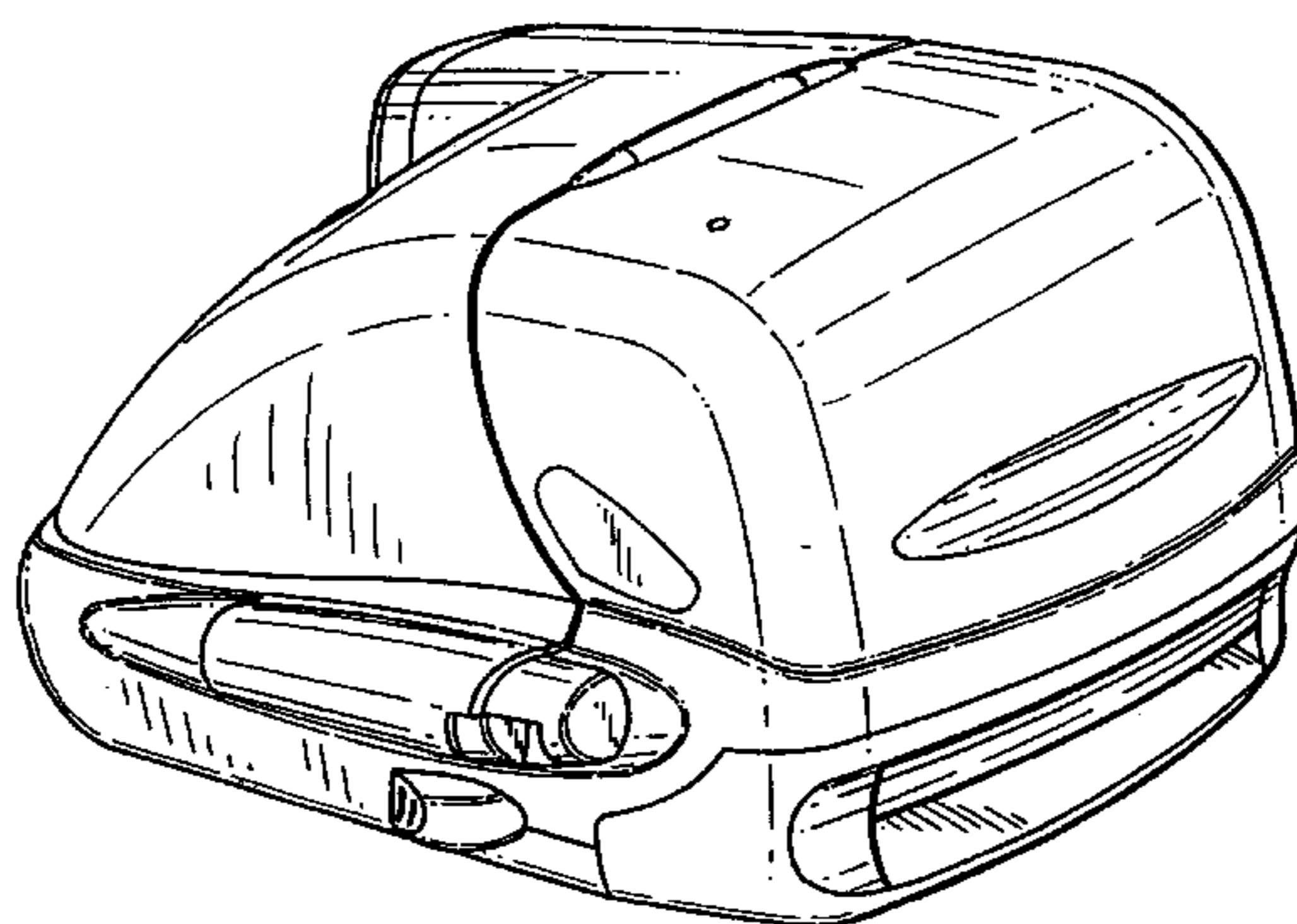

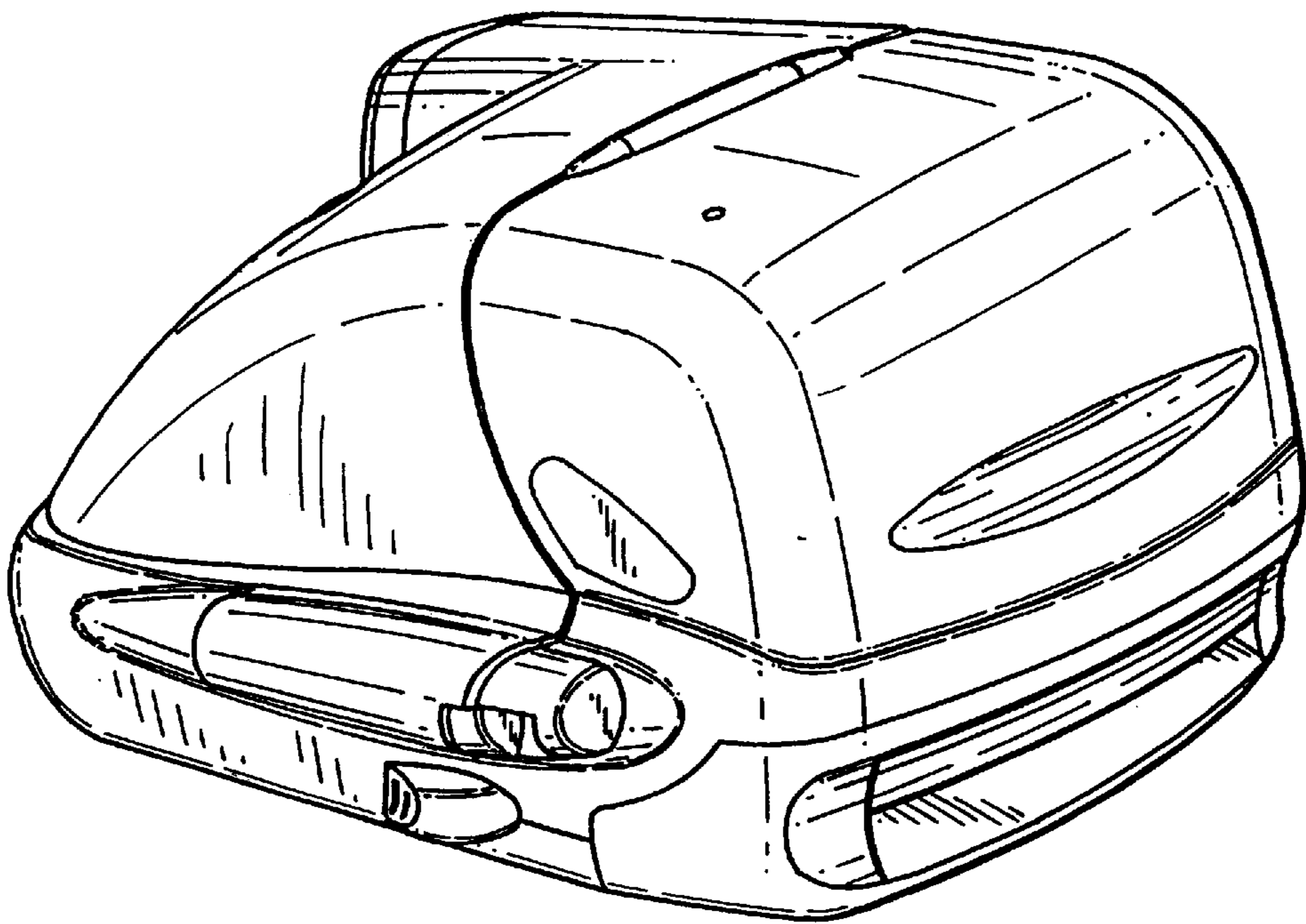

FIG. 1

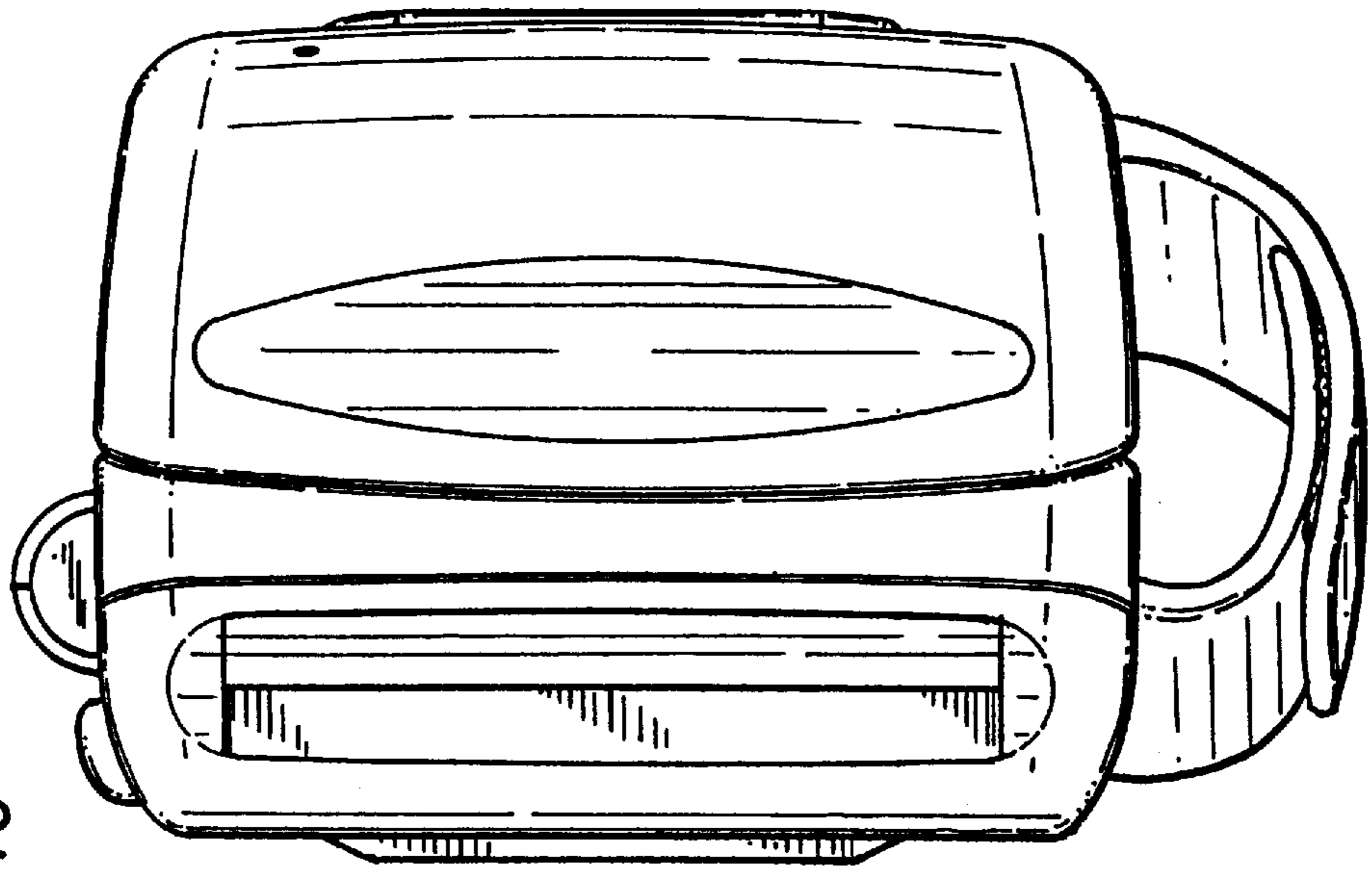

FIG. 2

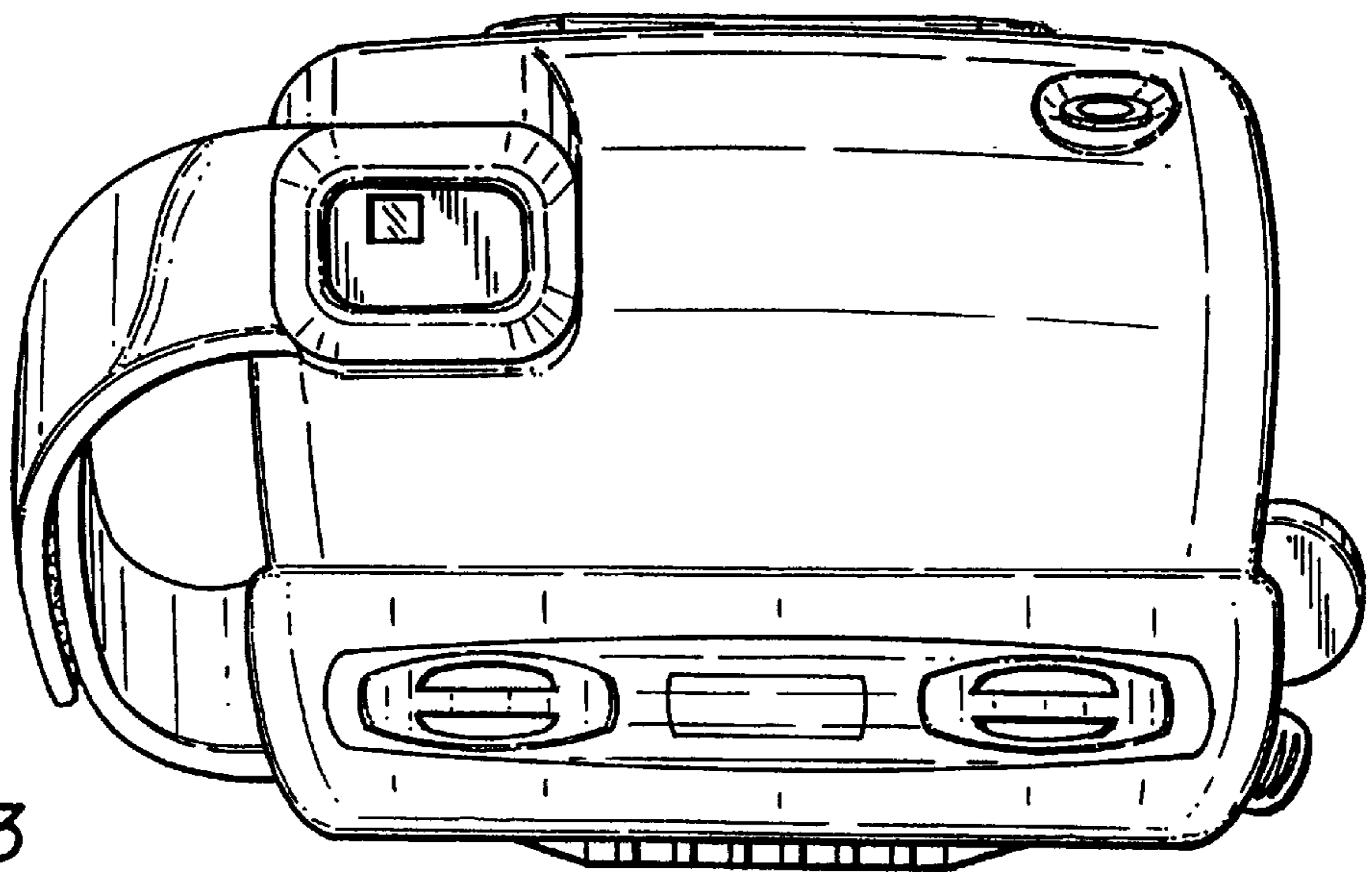

FIG. 3

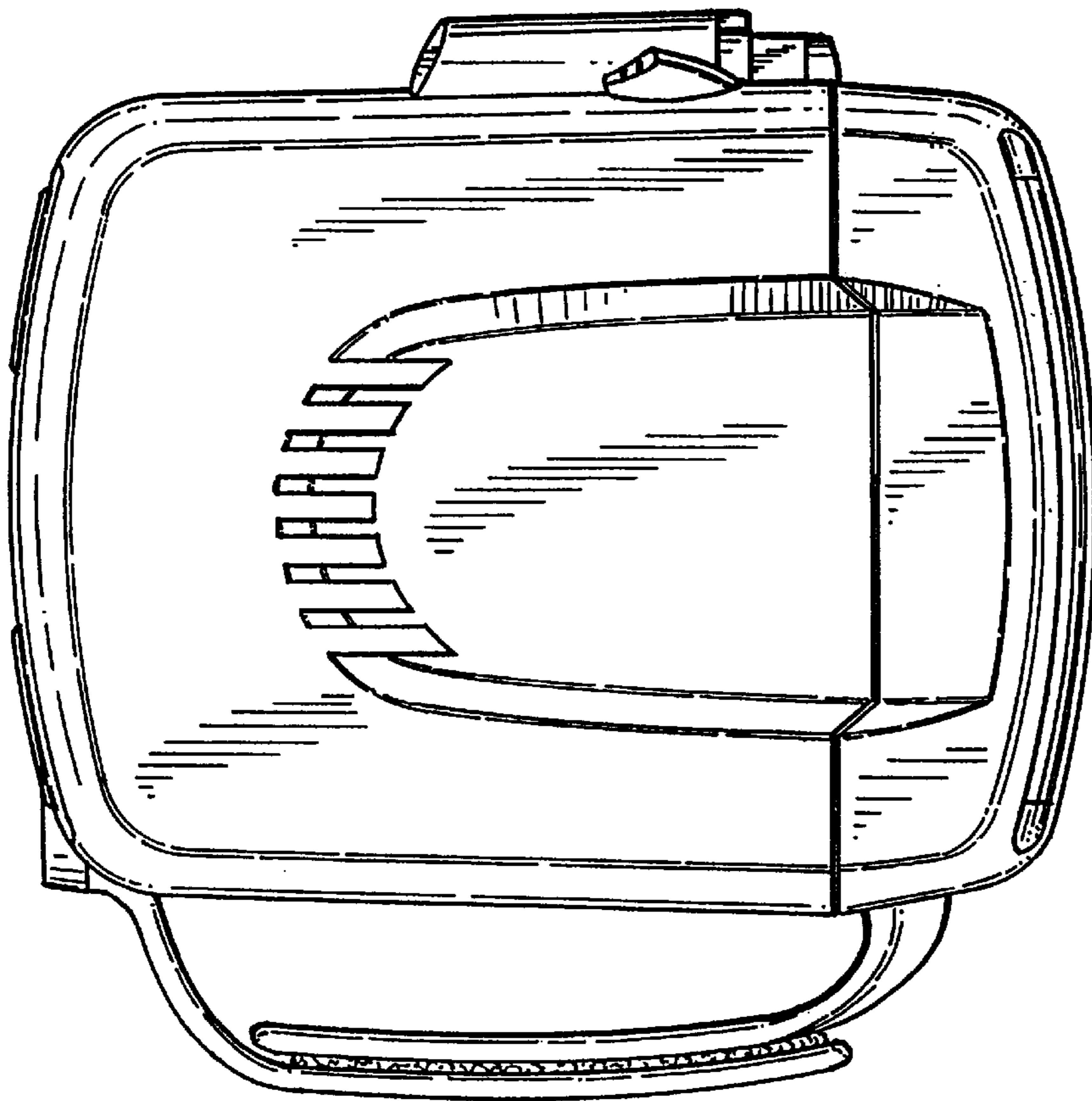

FIG. 5

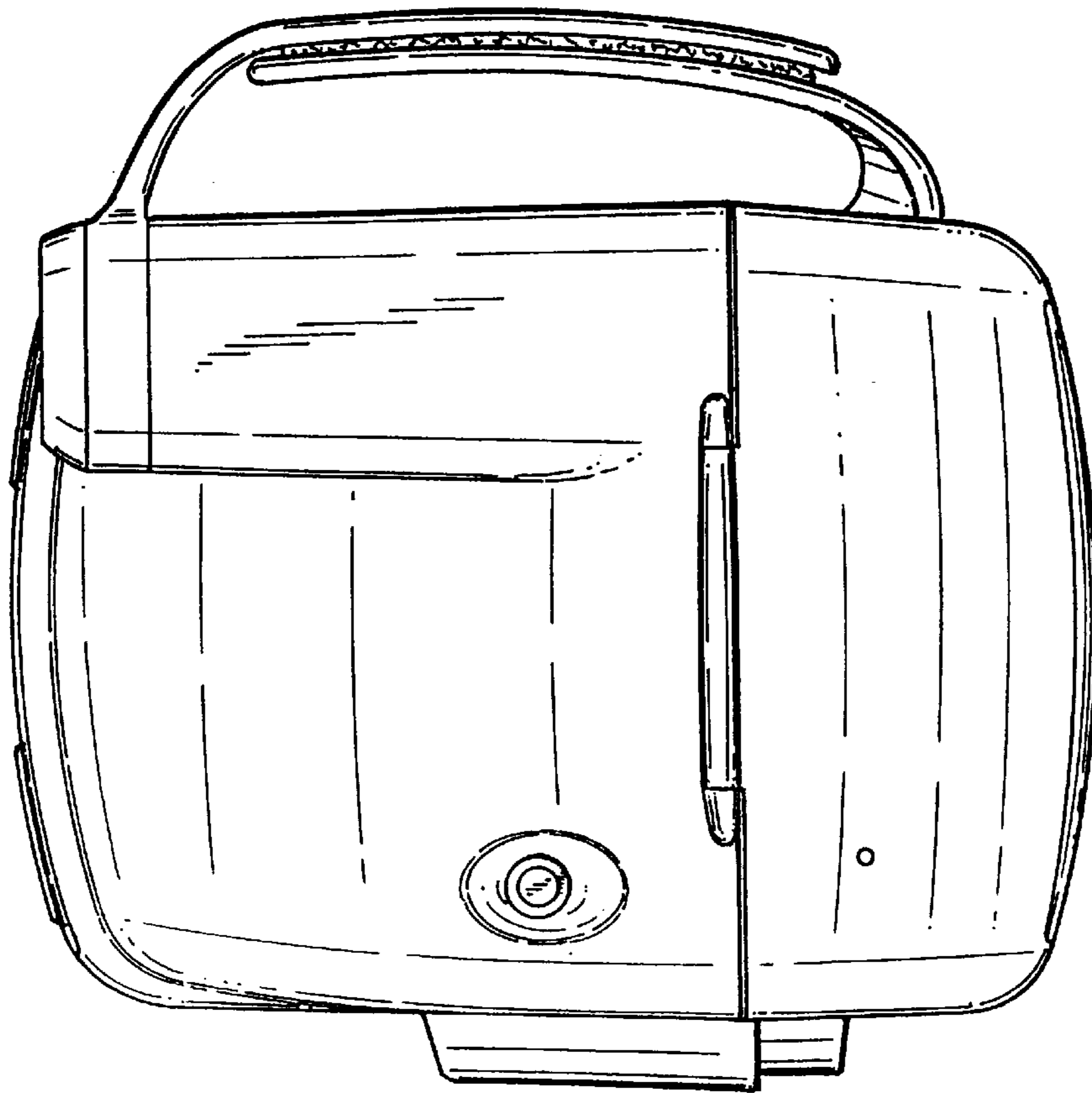

FIG. 4

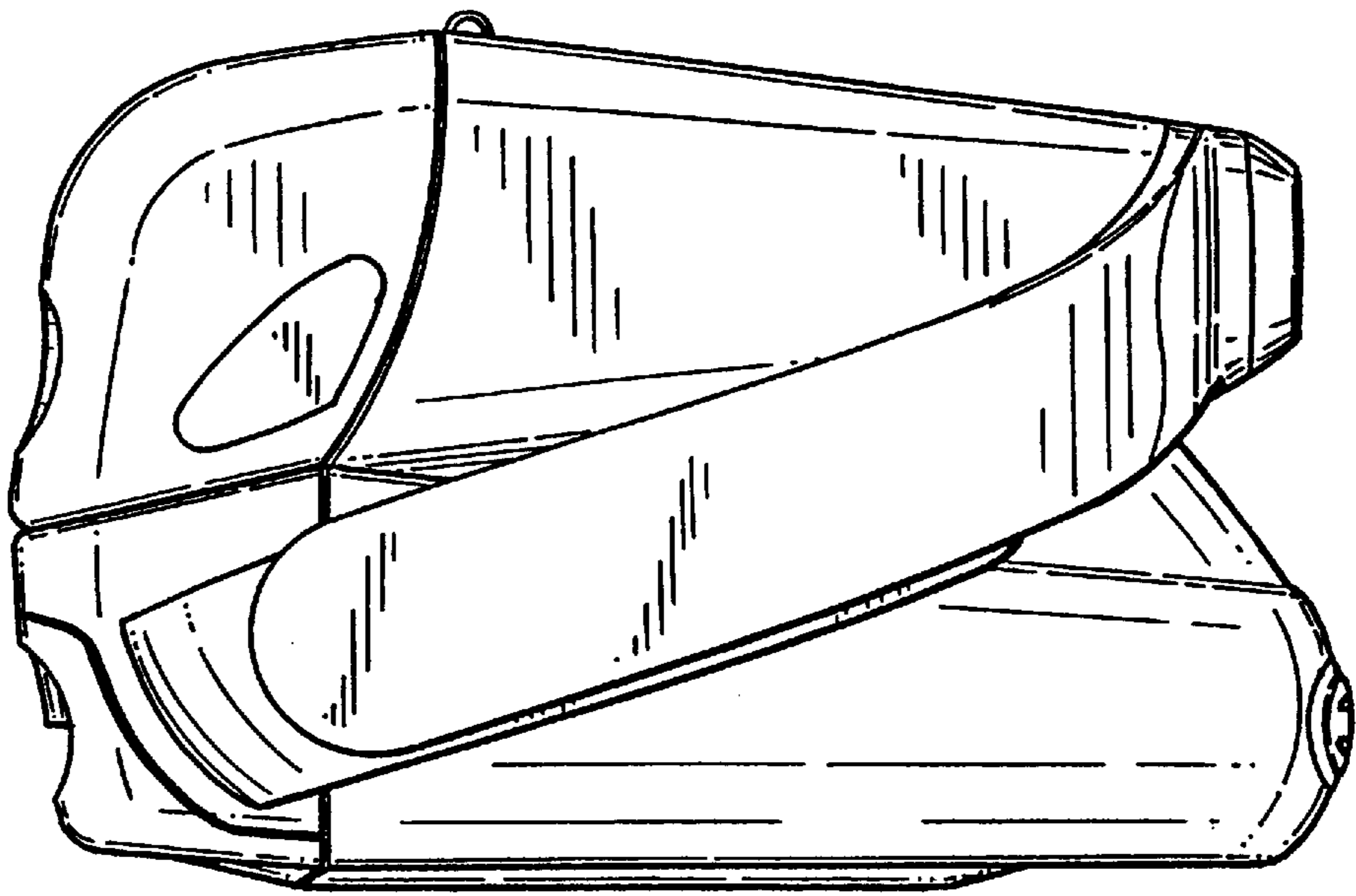

FIG. 6

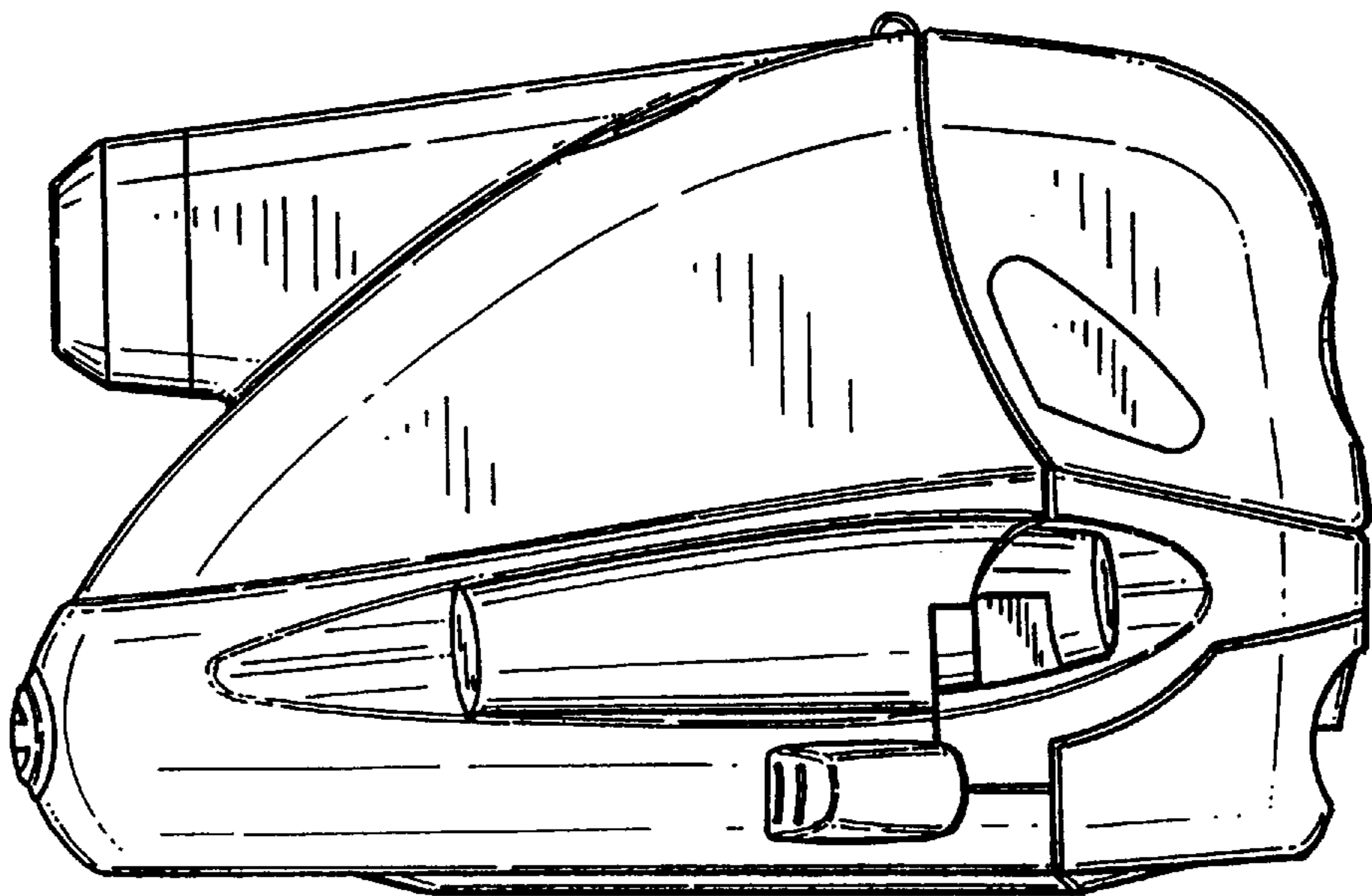

FIG. 7

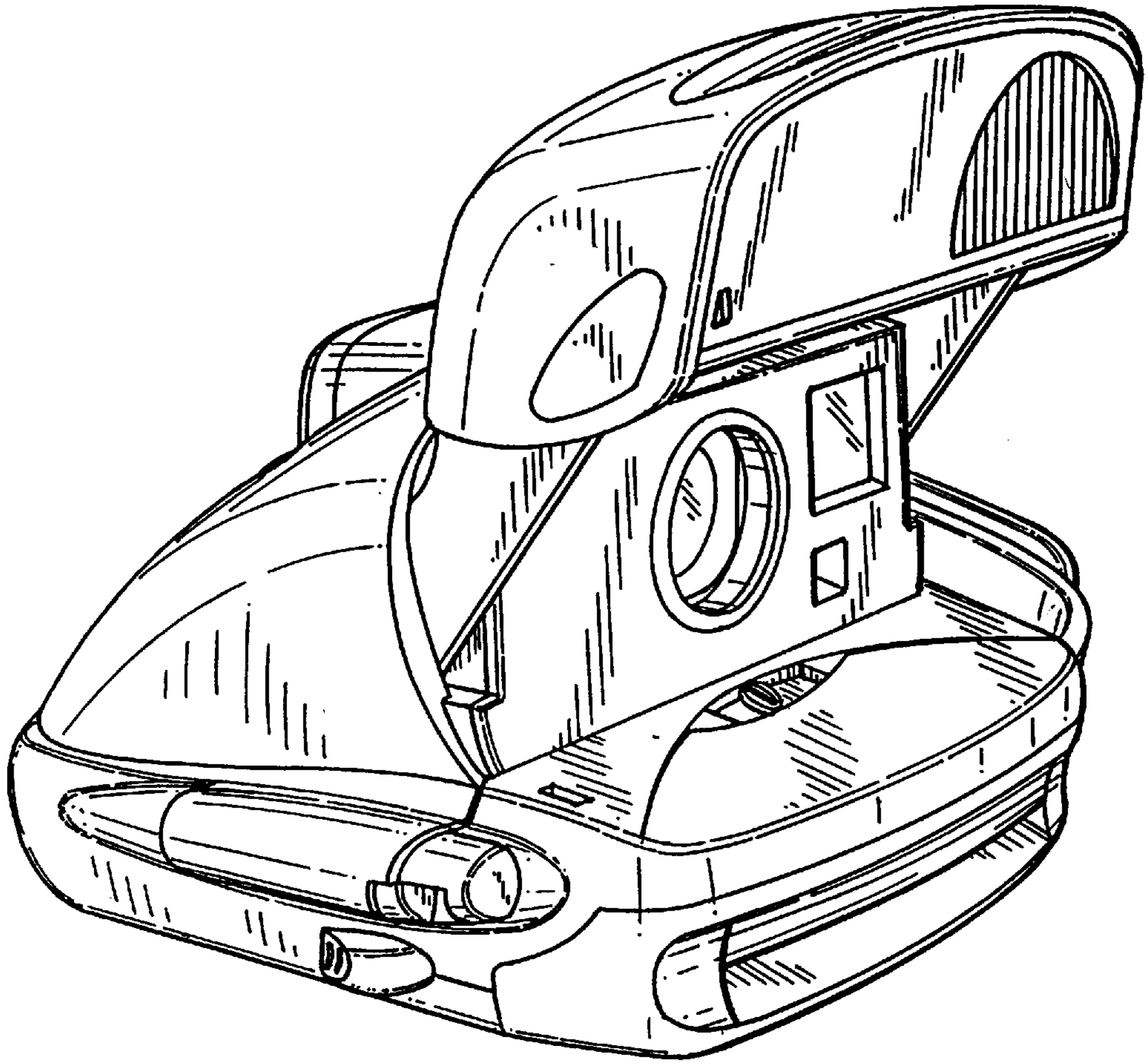

FIG. 8

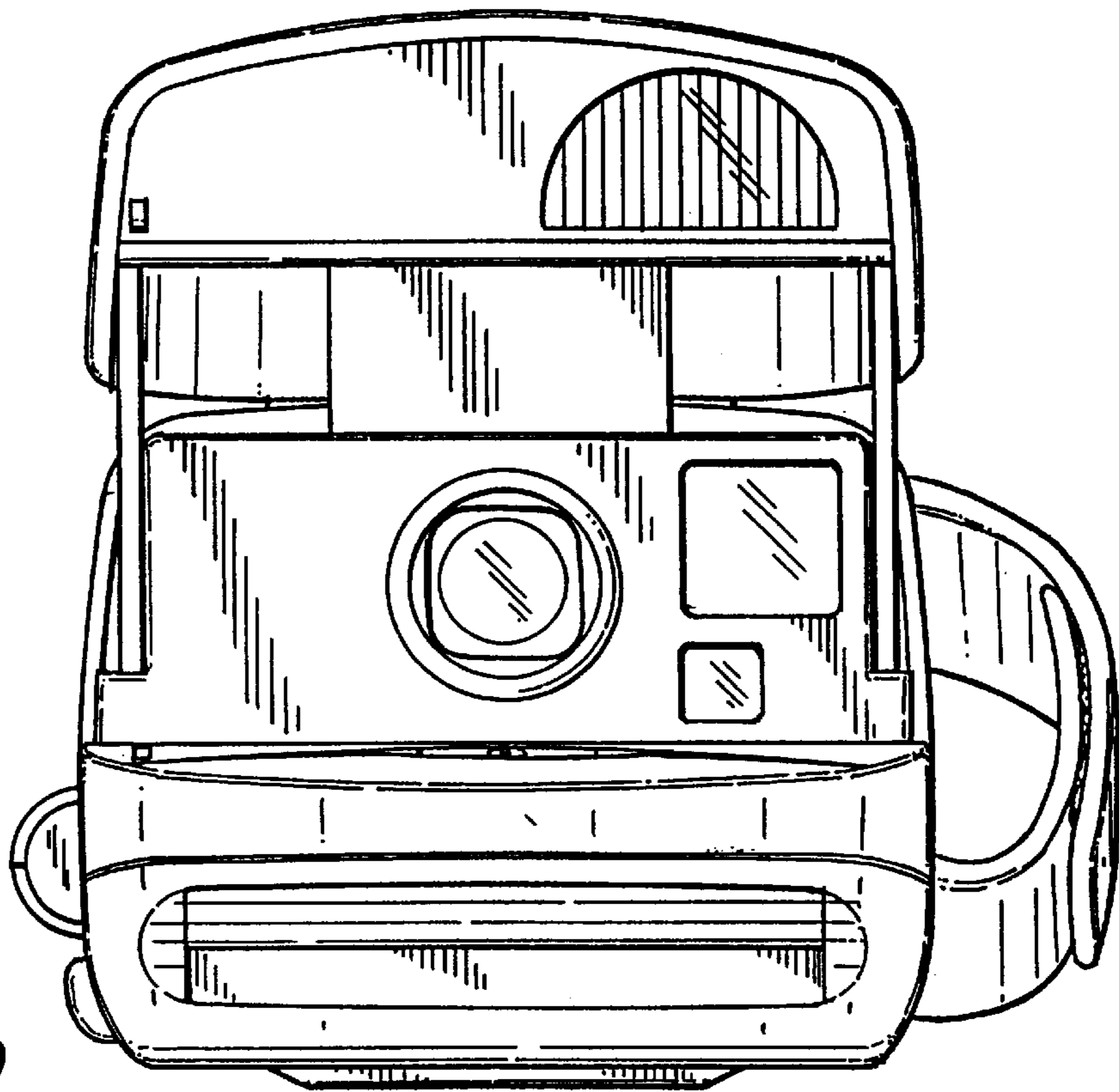

FIG. 9

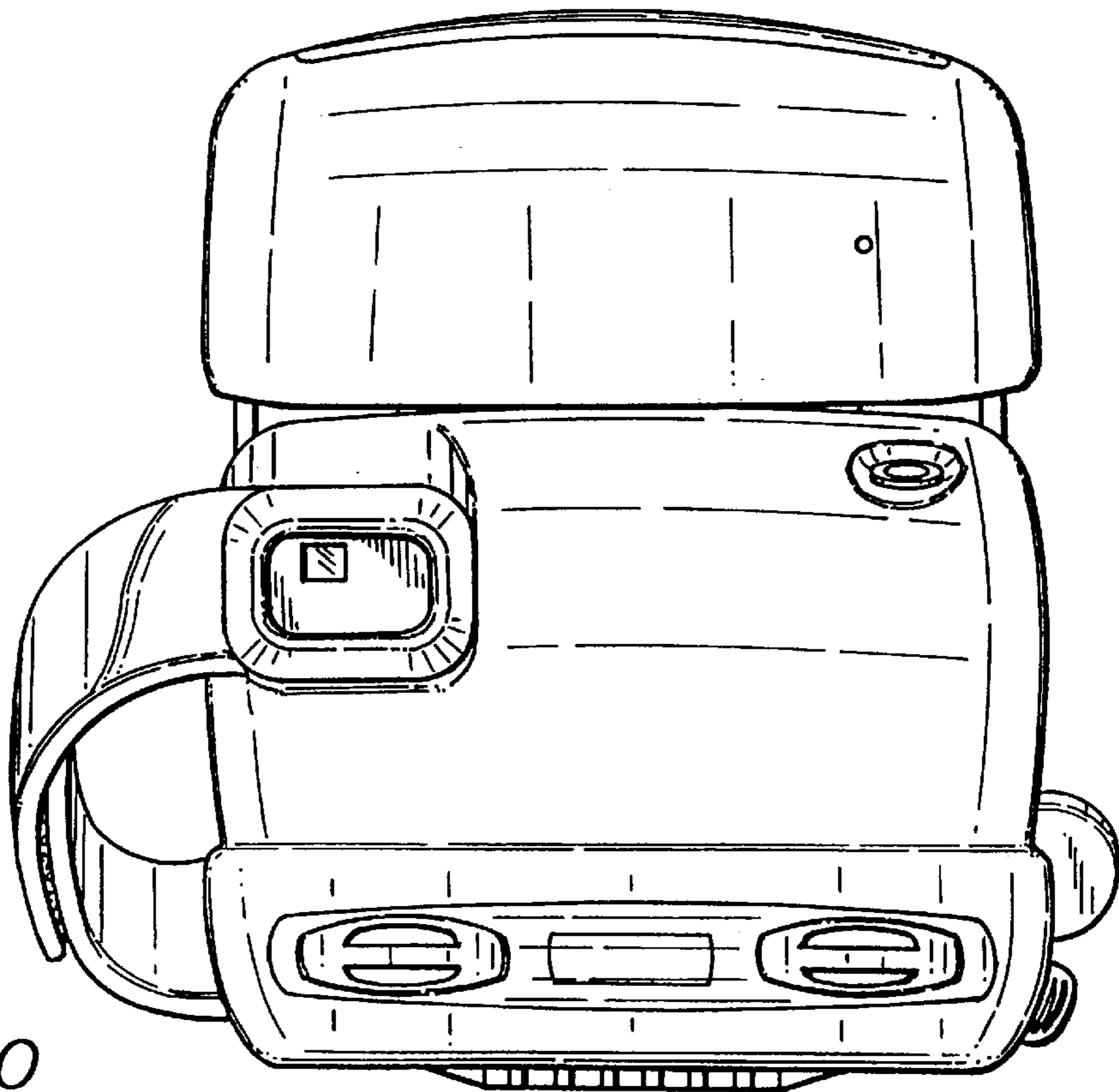

FIG. 10

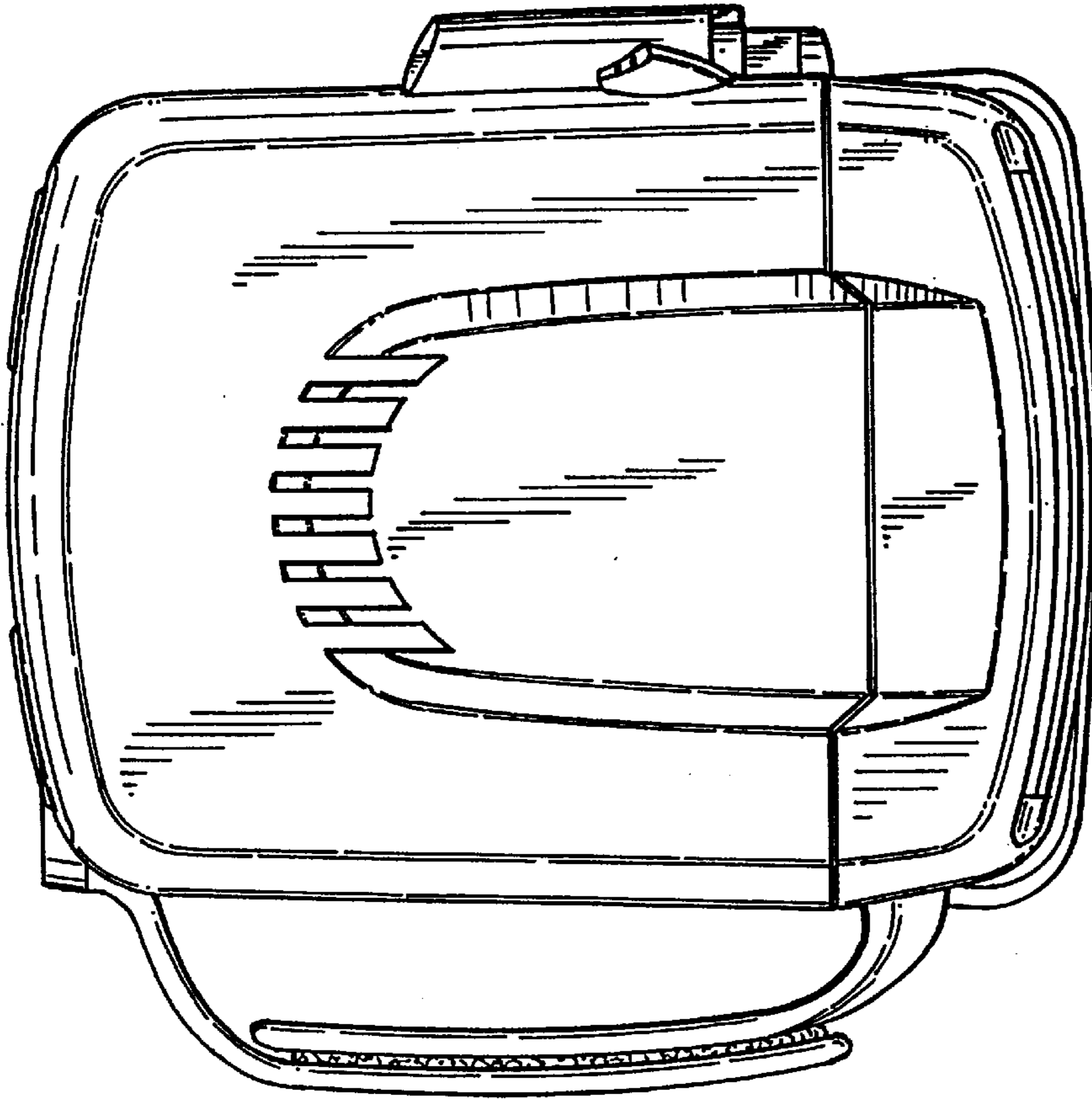

FIG. 12

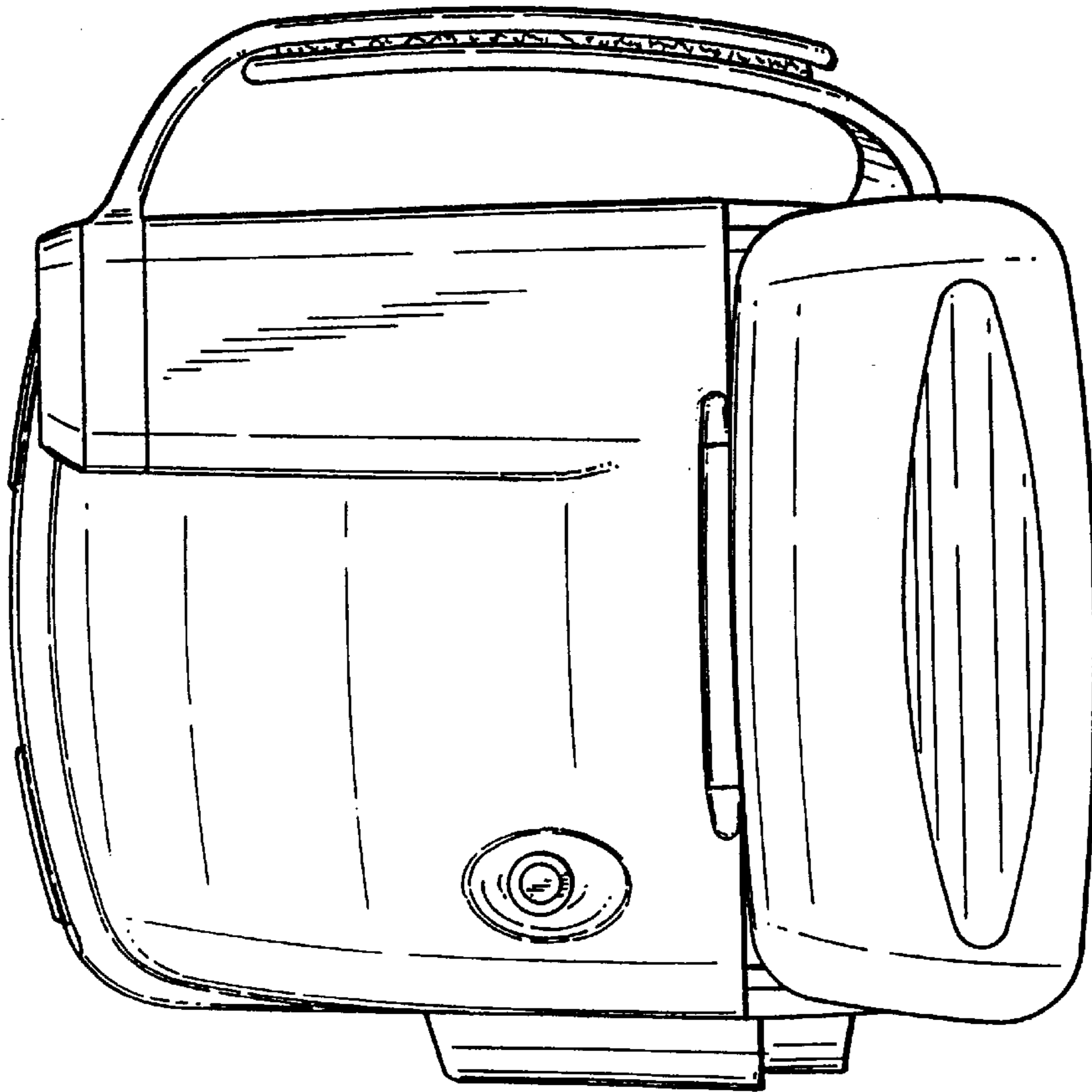

FIG. 11

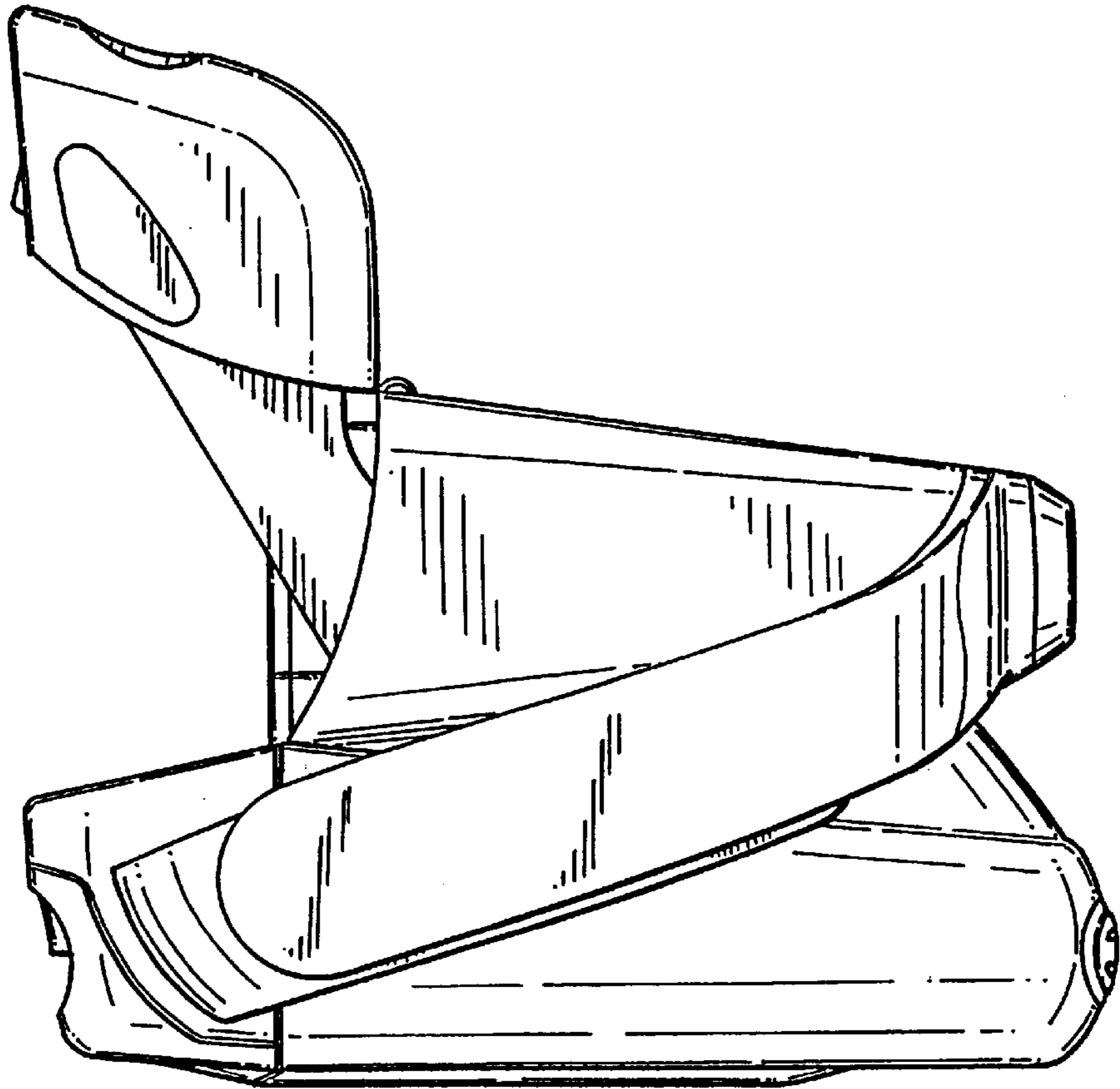

FIG. 13

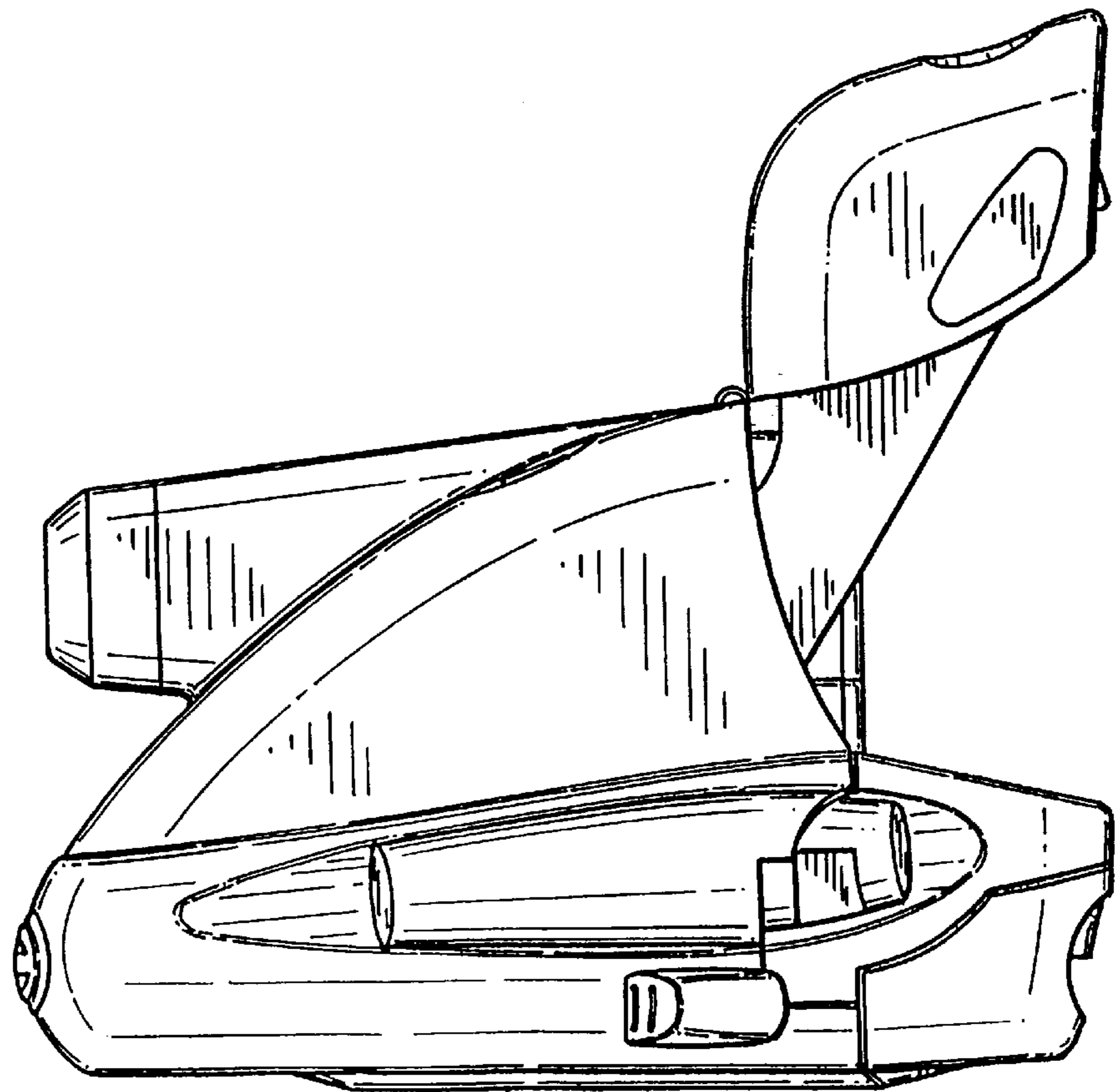

FIG. 14