



US00D400530S

United States Patent [19] Botden

[11] Patent Number: Des. 400,530

[45] Date of Patent: **Nov. 3, 1998

[54] HI-FI SYSTEM

[75] Inventor: Jeroen C. Botden, Braga, Portugal

[73] Assignee: Grundig AG, Germany

[**] Term: 14 Years

[21] Appl. No.: 57,243

[22] Filed: Jul. 19, 1996

[51] LOC (6) Cl. 14-01

[52] U.S. Cl. D14/168; D14/214

[58] Field of Search D14/124, 156,
D14/168, 188-190, 192-19, 204, 207, 209-216;
181/144-145, 147-148, 157, 198-199;
381/24, 88, 90, 153, 159, 186, 188, 203,
205; 455/344, 347-351

[56] **References Cited**

U.S. PATENT DOCUMENTS

D. 34,703	8/1901	Kawamoto	D14/211
D. 339,345	9/1993	Fuke	D14/168
D. 349,731	8/1994	Witzky	D14/204 X
D. 350,754	9/1994	Sasago	D14/168

OTHER PUBLICATIONS

Stereo Review, p. 48, Carver AL-III Loudspeaker system, Jul. 1993.

Primary Examiner—Sandra L. Morris
Assistant Examiner—Nanda Bondade
Attorney, Agent, or Firm—Walter A. Hackler

[57] **CLAIM**

The ornamental design for HI-FI system, as shown and described.

DESCRIPTION

FIG. 1 is a top view of the present invention;
 FIG. 2 is a front, top and right side perspective view of the present invention;
 FIG. 3 is a left side view of the present invention;
 FIG. 4 is a back view of the present invention;
 FIG. 5 is a bottom view of the present invention;
 FIG. 6 is a top view of an alternative embodiment of the present invention;
 FIG. 7 is a left side view of the embodiment shown in FIG. 6;
 FIG. 8 is a front, top and right side perspective view of the embodiment shown in FIG. 6;
 FIG. 9 is a back view of the embodiment shown in FIG. 6;
 FIG. 10 is a bottom view of the embodiment shown in FIG. 6;
 FIG. 11 is an enlarged perspective view of the control panel features of the present invention shown in FIGS. 1 and 6, shown separately for clarity of illustration;
 FIG. 12 is a left side view of the control panel features shown in FIG. 11;
 FIG. 13 is a right side view of the control panel shown in FIG. 11; and,
 FIG. 14 is a bottom view of the control panel shown in FIG. 12.
 The broken line showing in FIGS. 11-14 is for illustrative purposes only and forms no part of the claimed design.

1 Claim, 6 Drawing Sheets

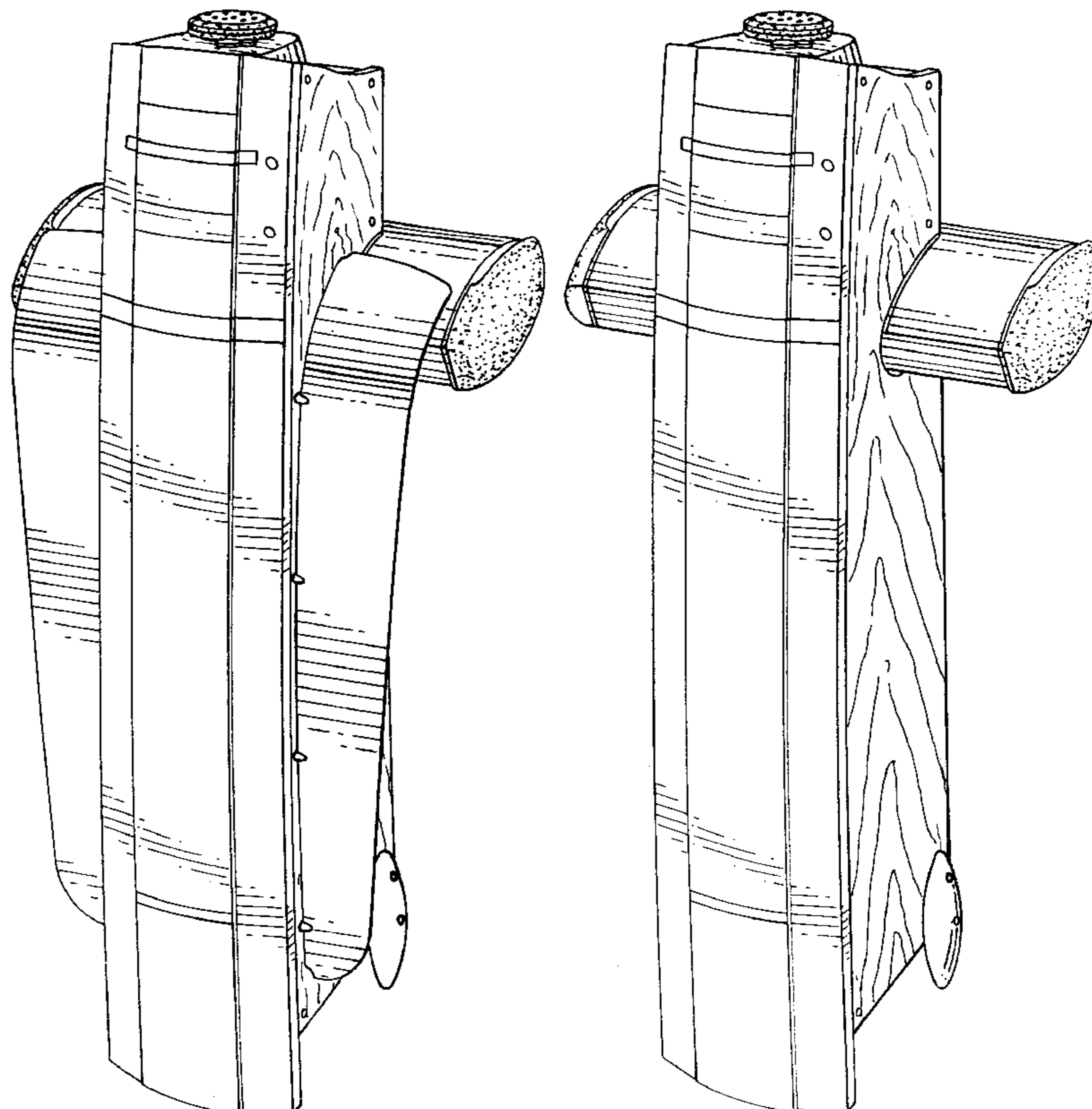

FIG. 1.

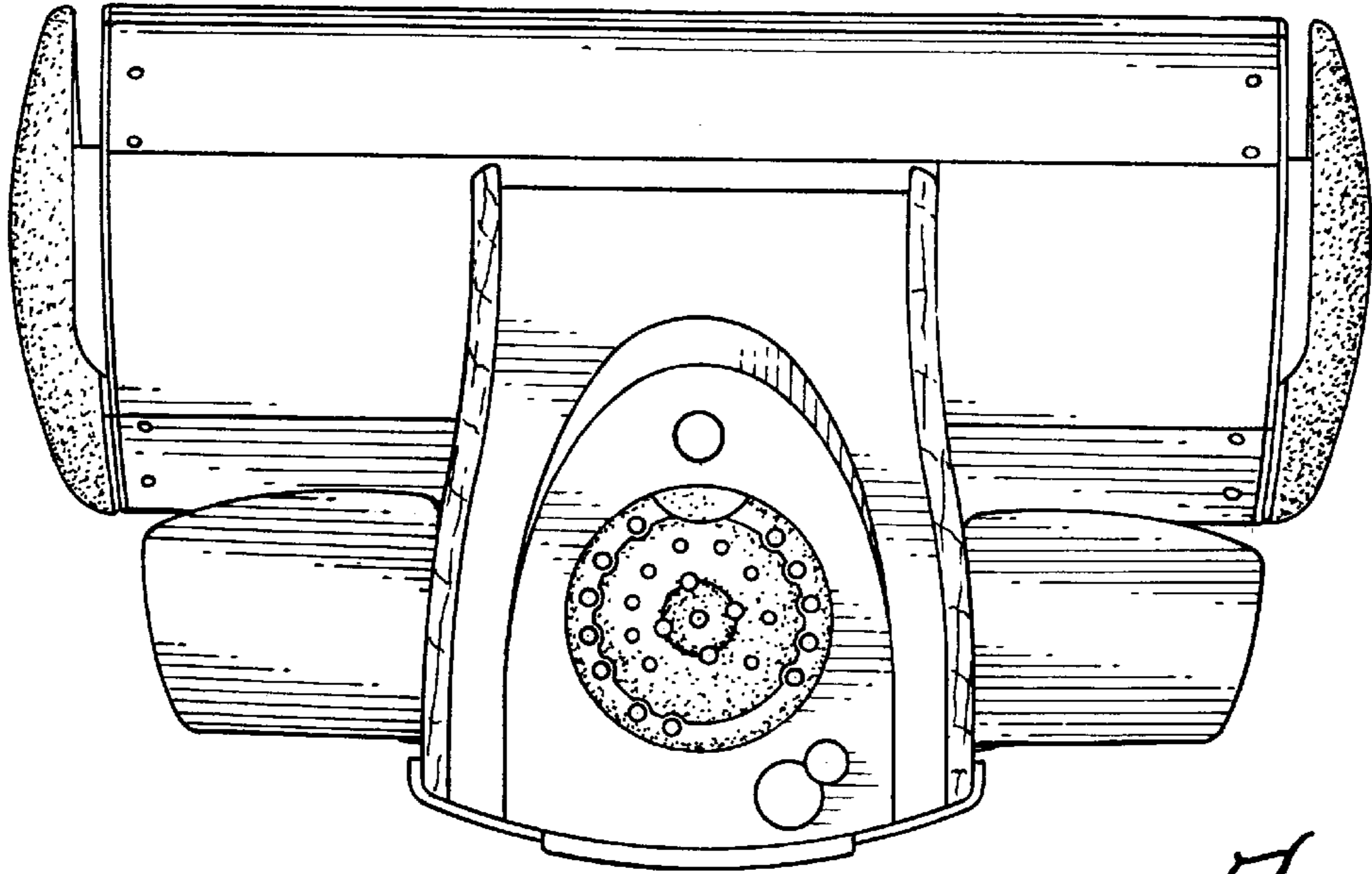

FIG. 3.

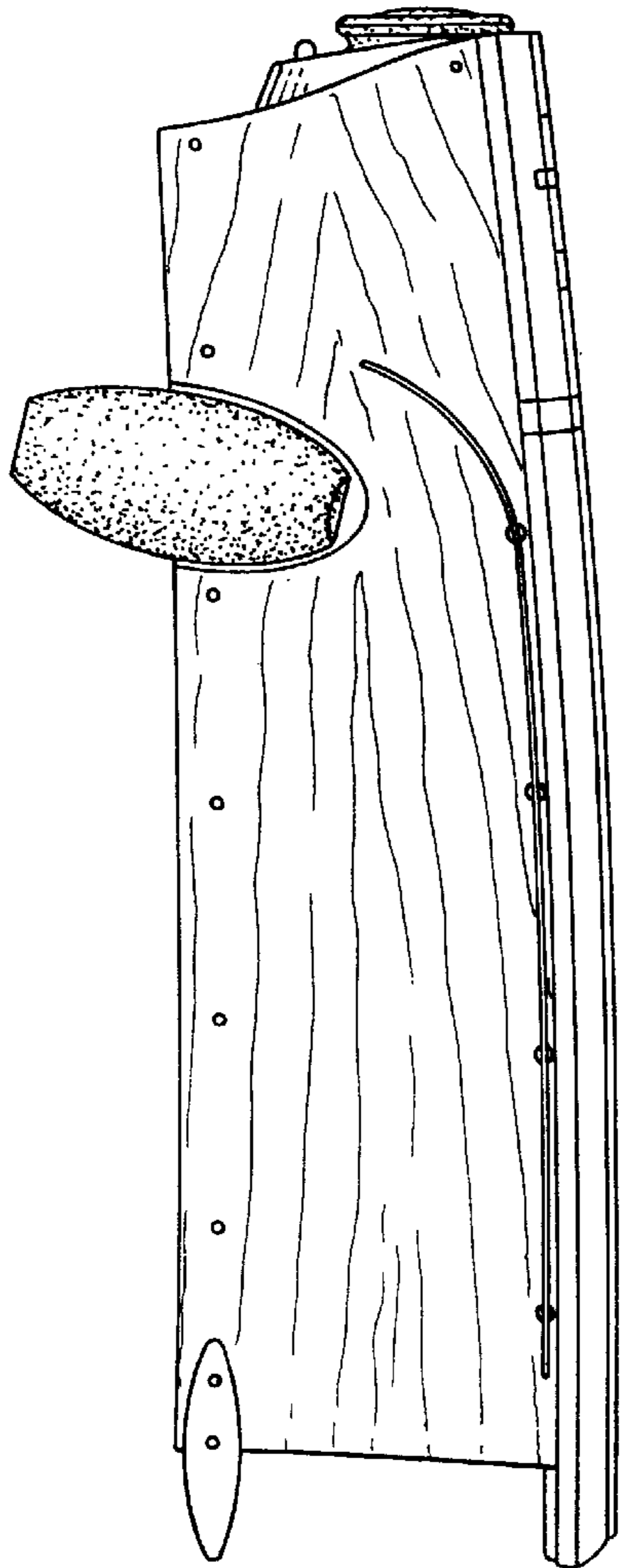

FIG. 2.

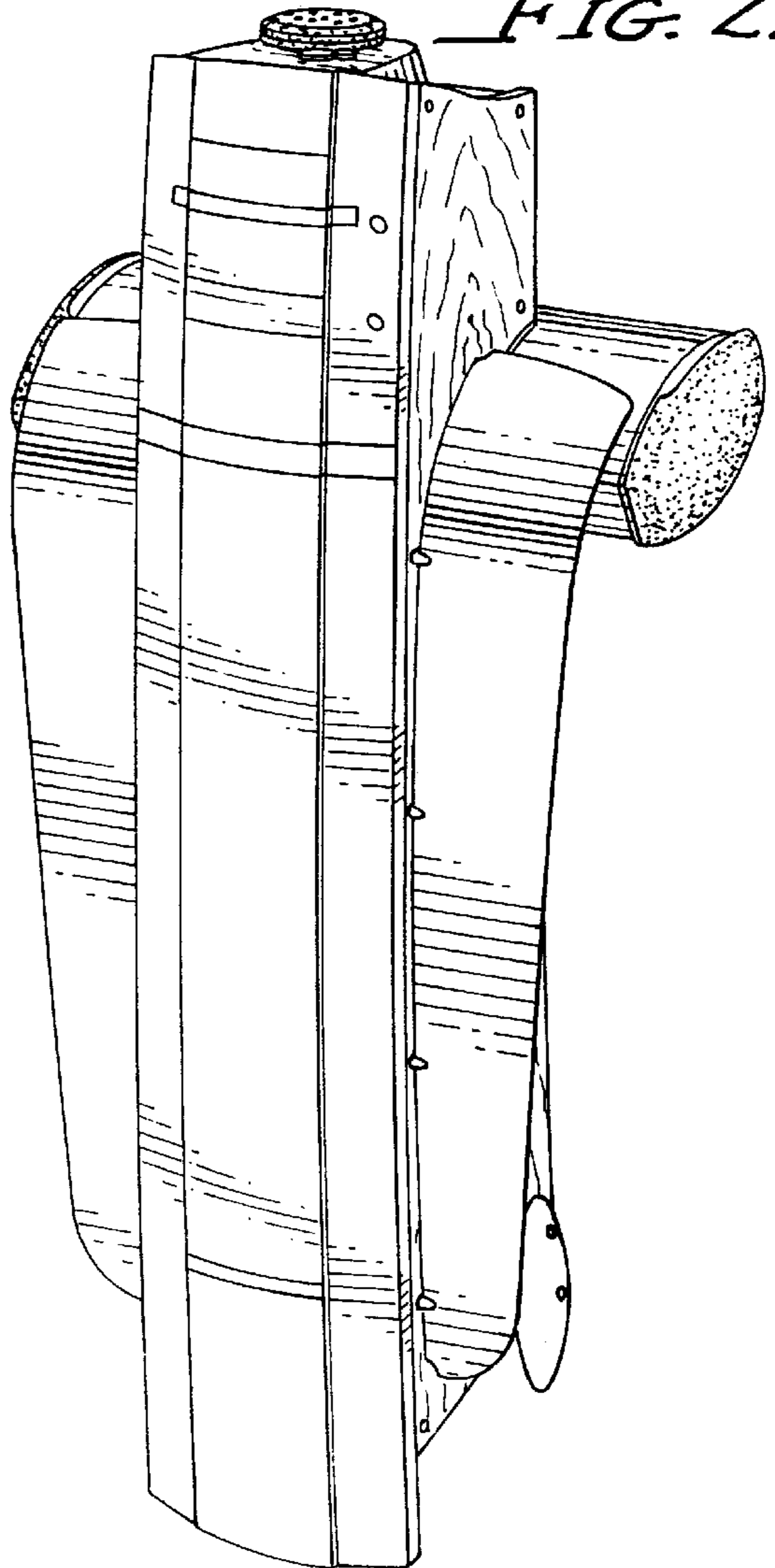

FIG. 4.

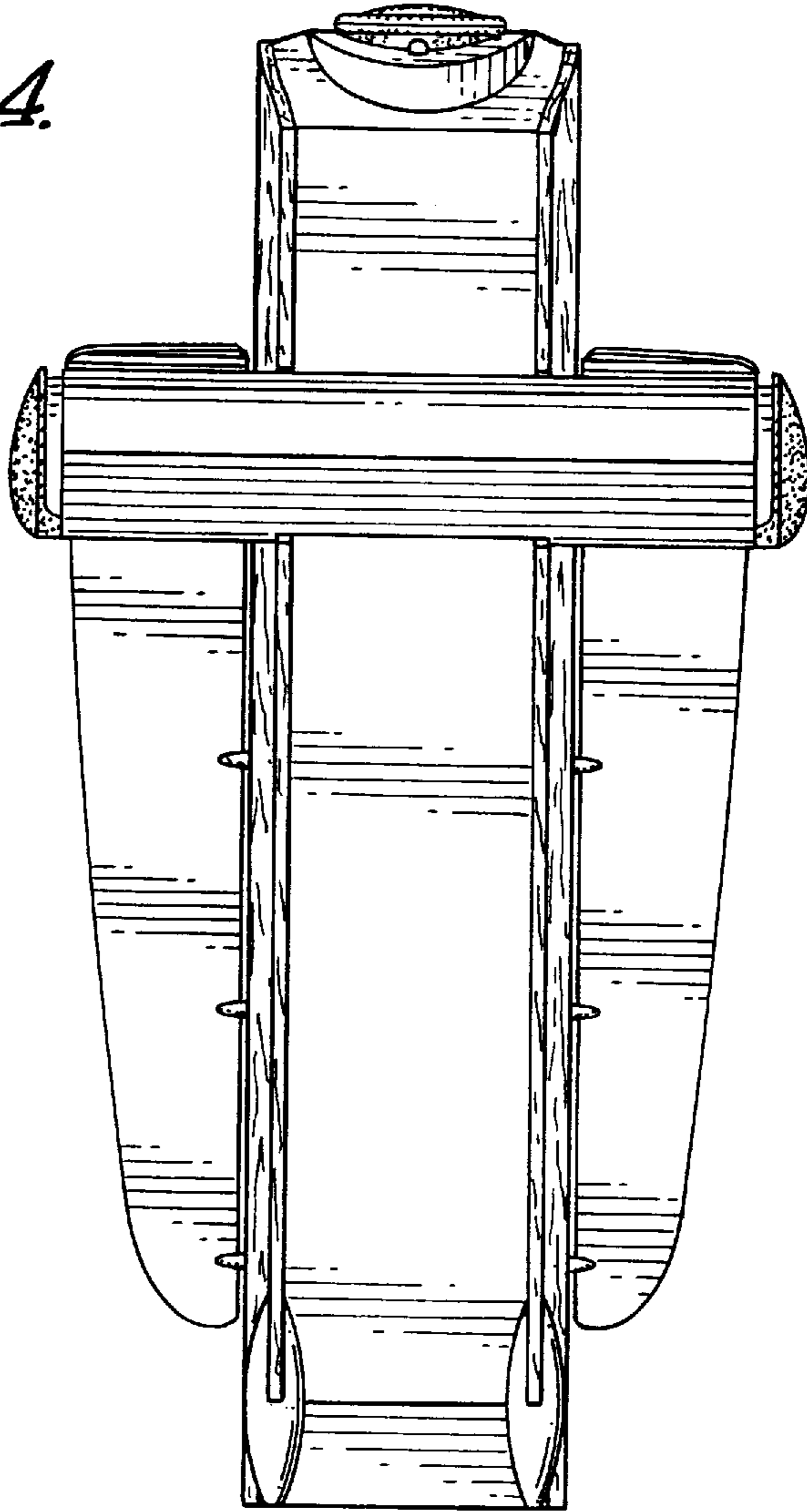

FIG. 5.

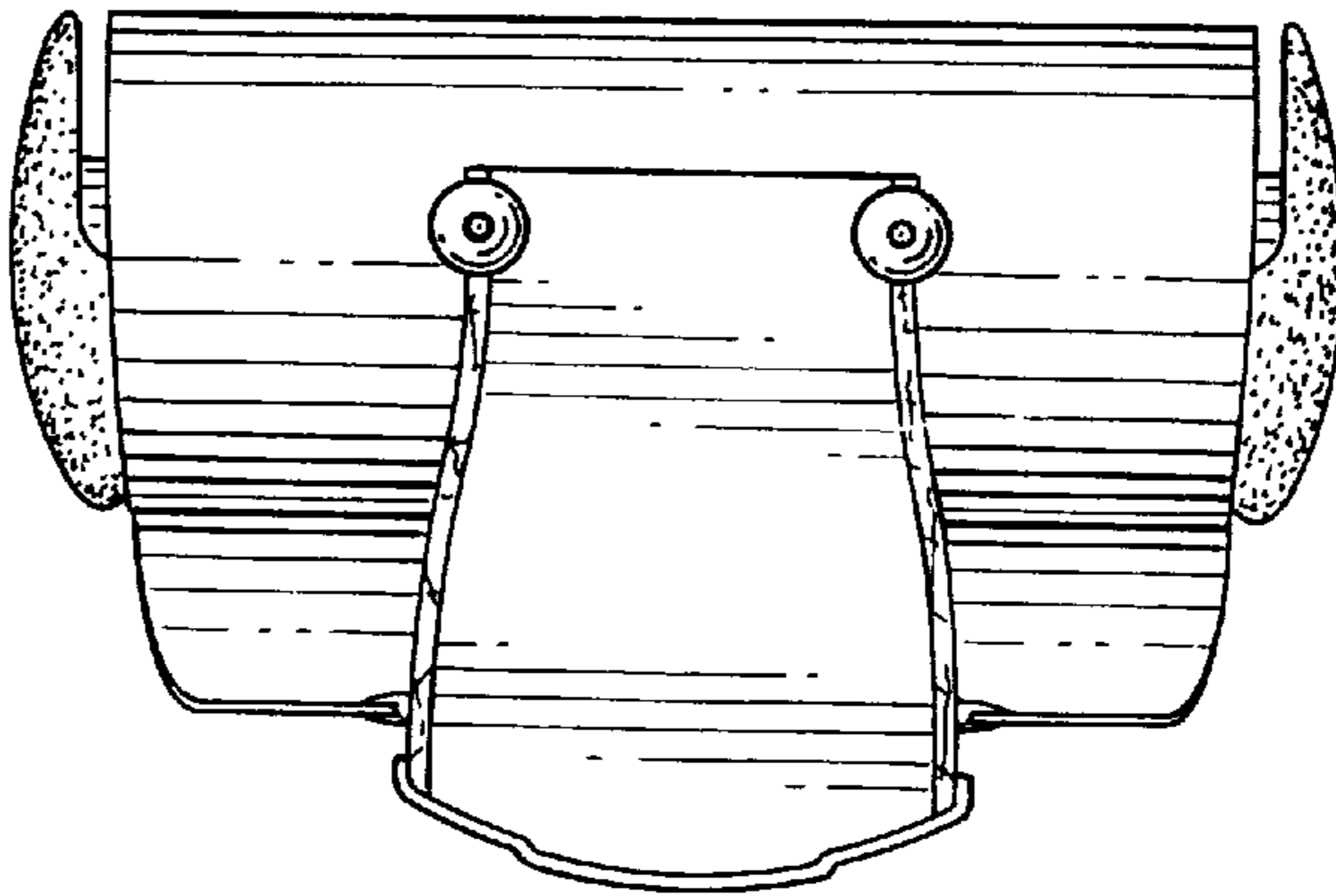

FIG. 6.

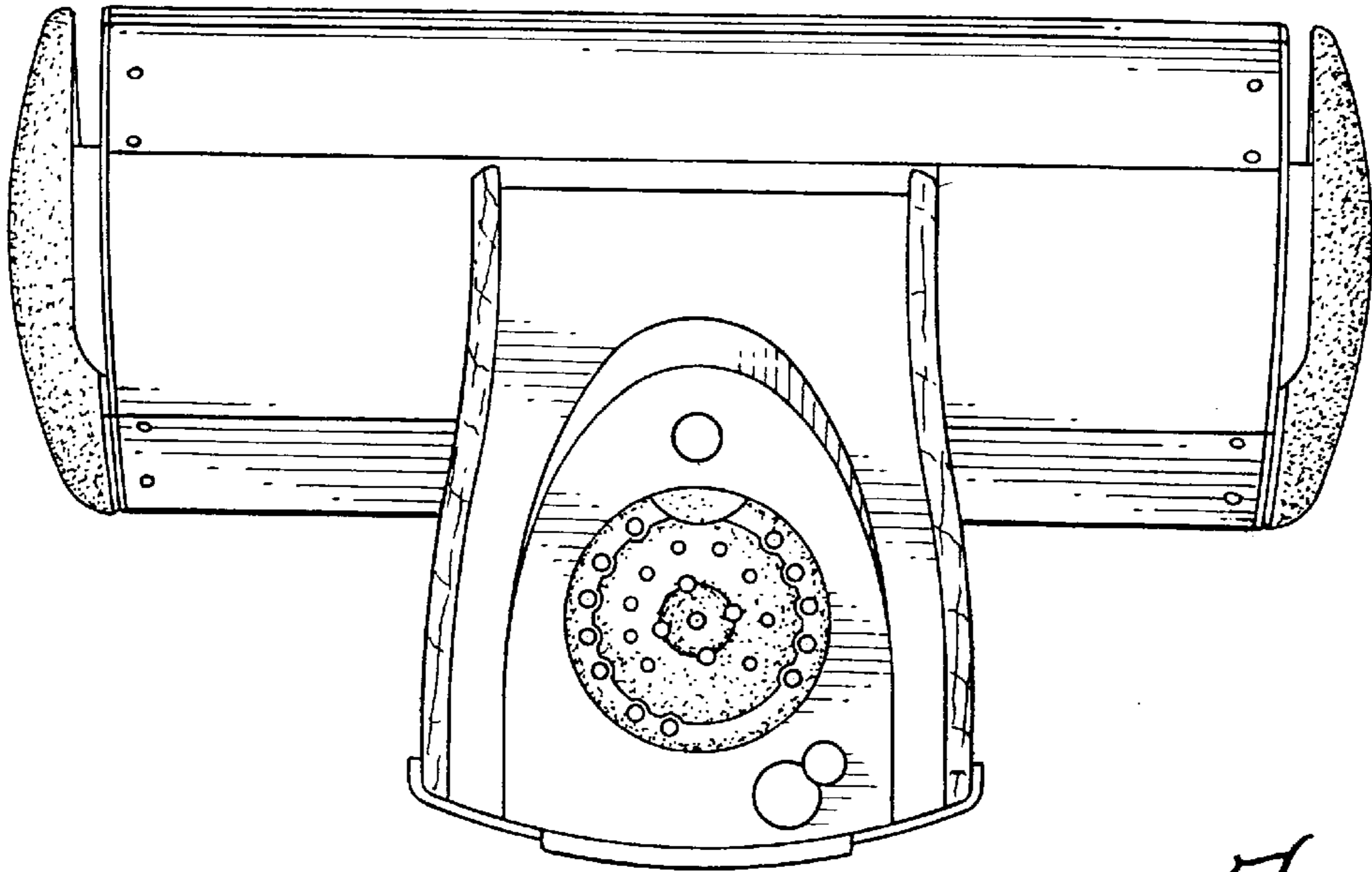

FIG. 7.

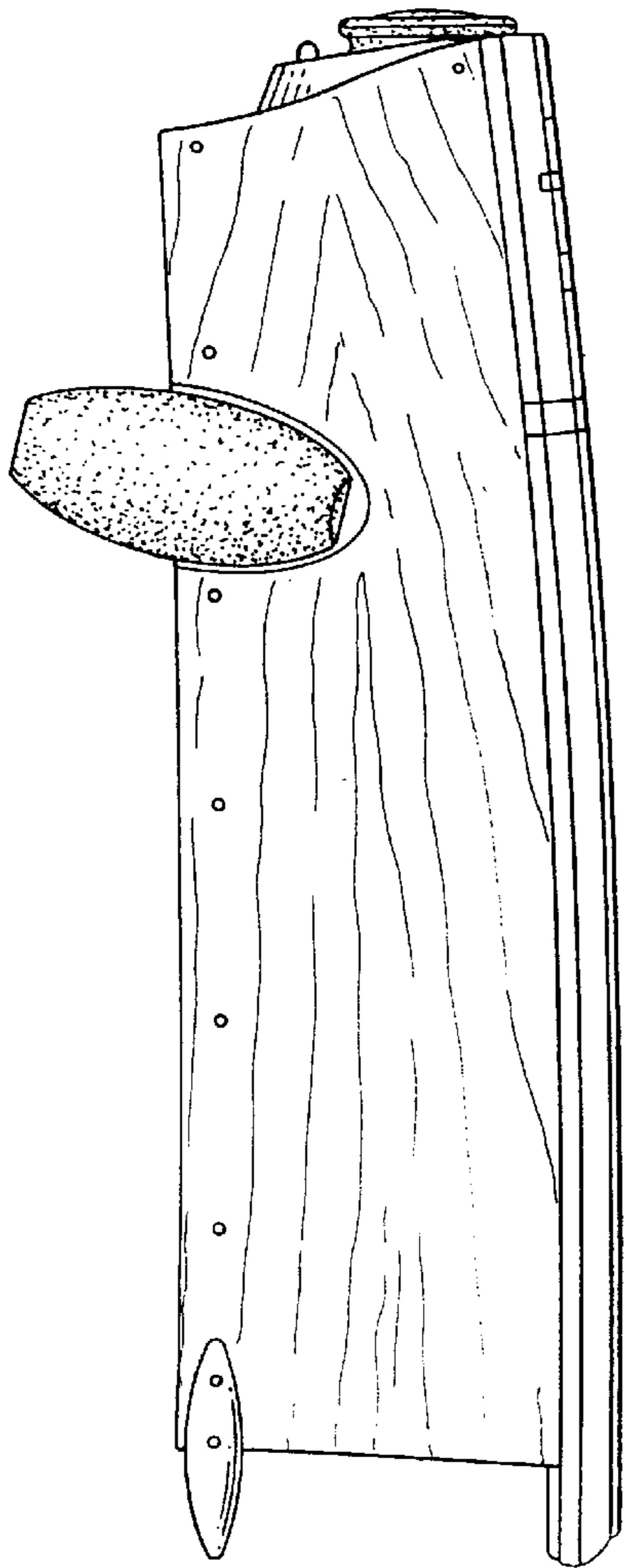

FIG. 8.

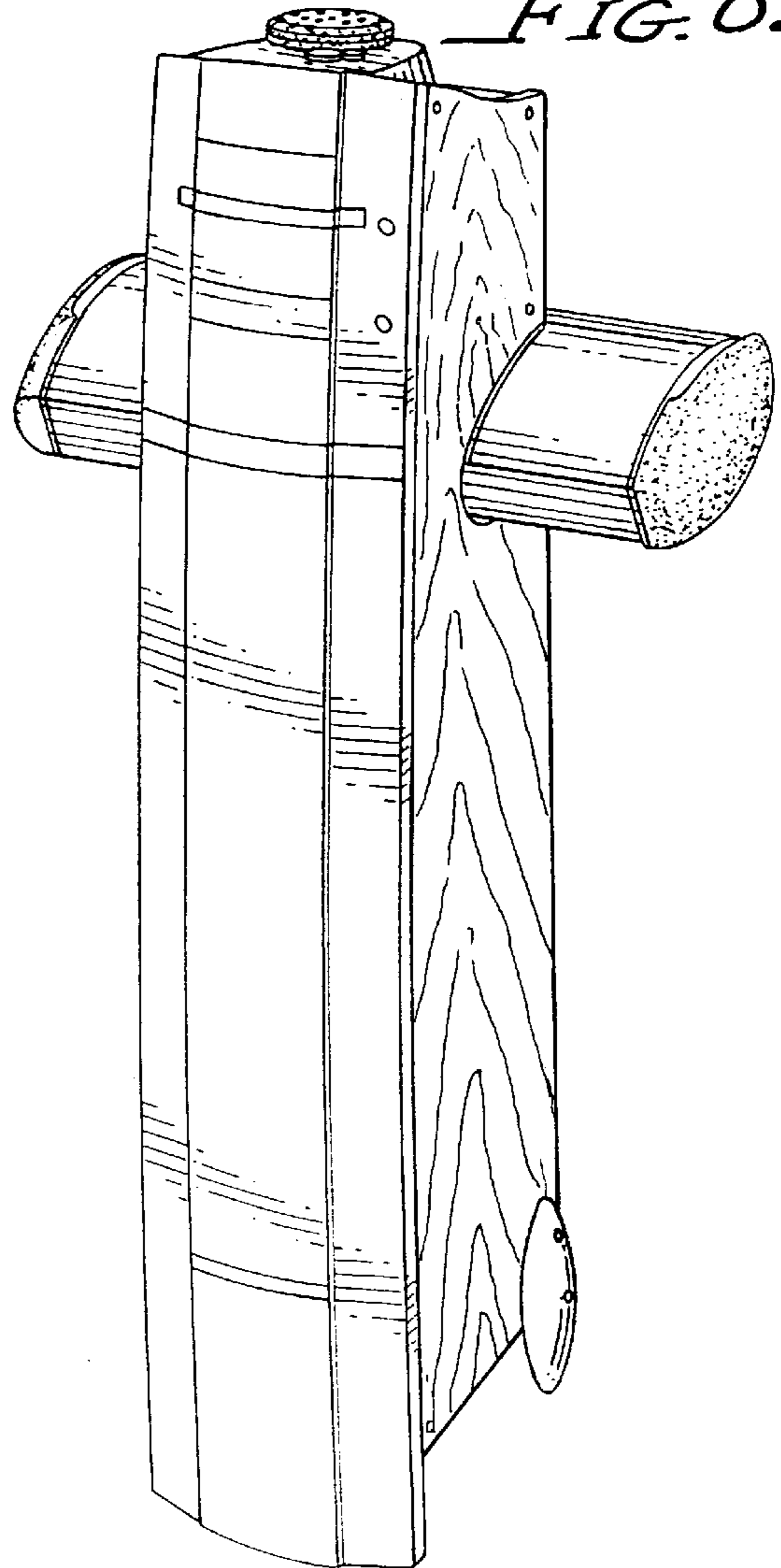

FIG. 9.

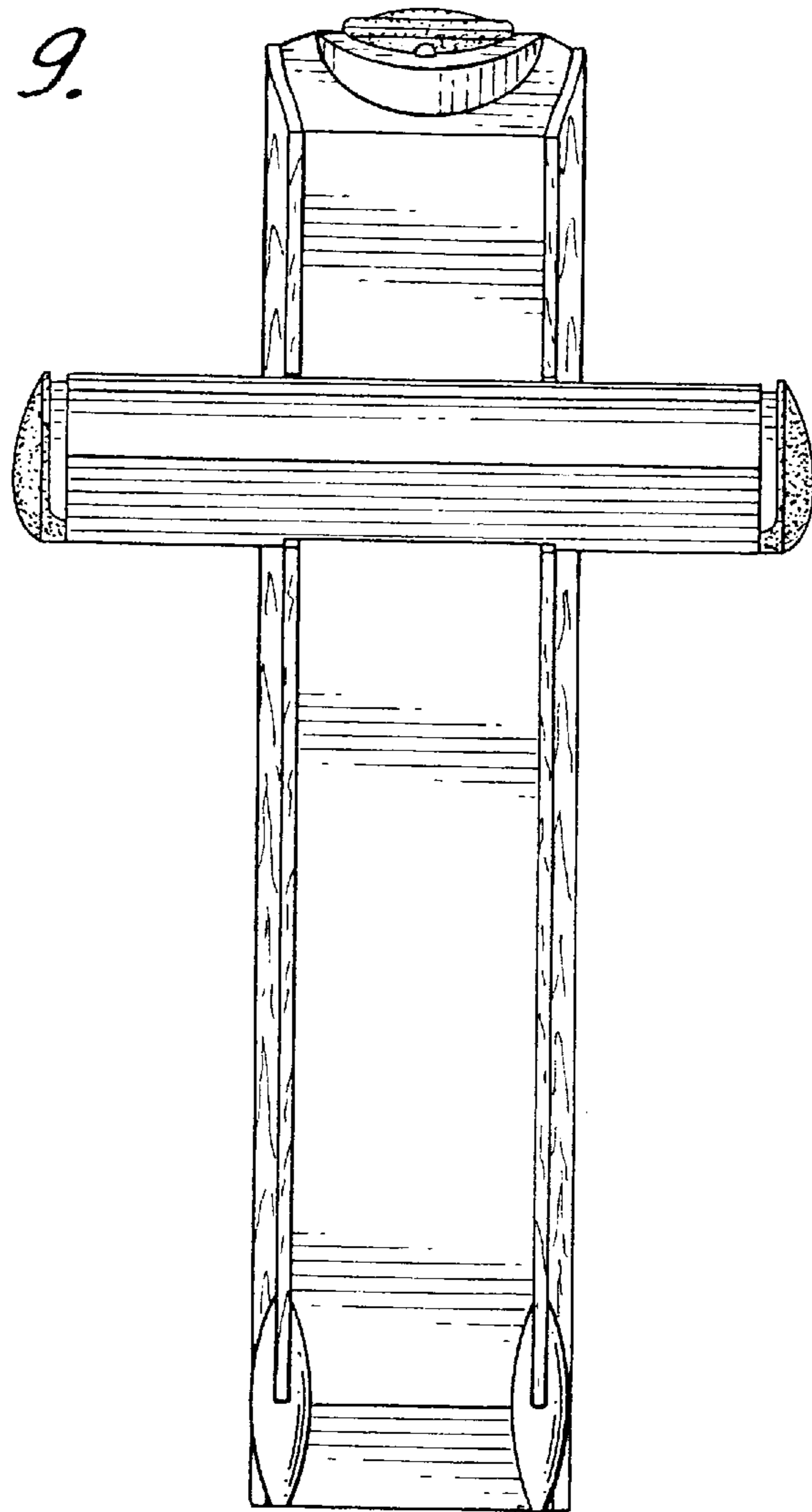

FIG. 10.

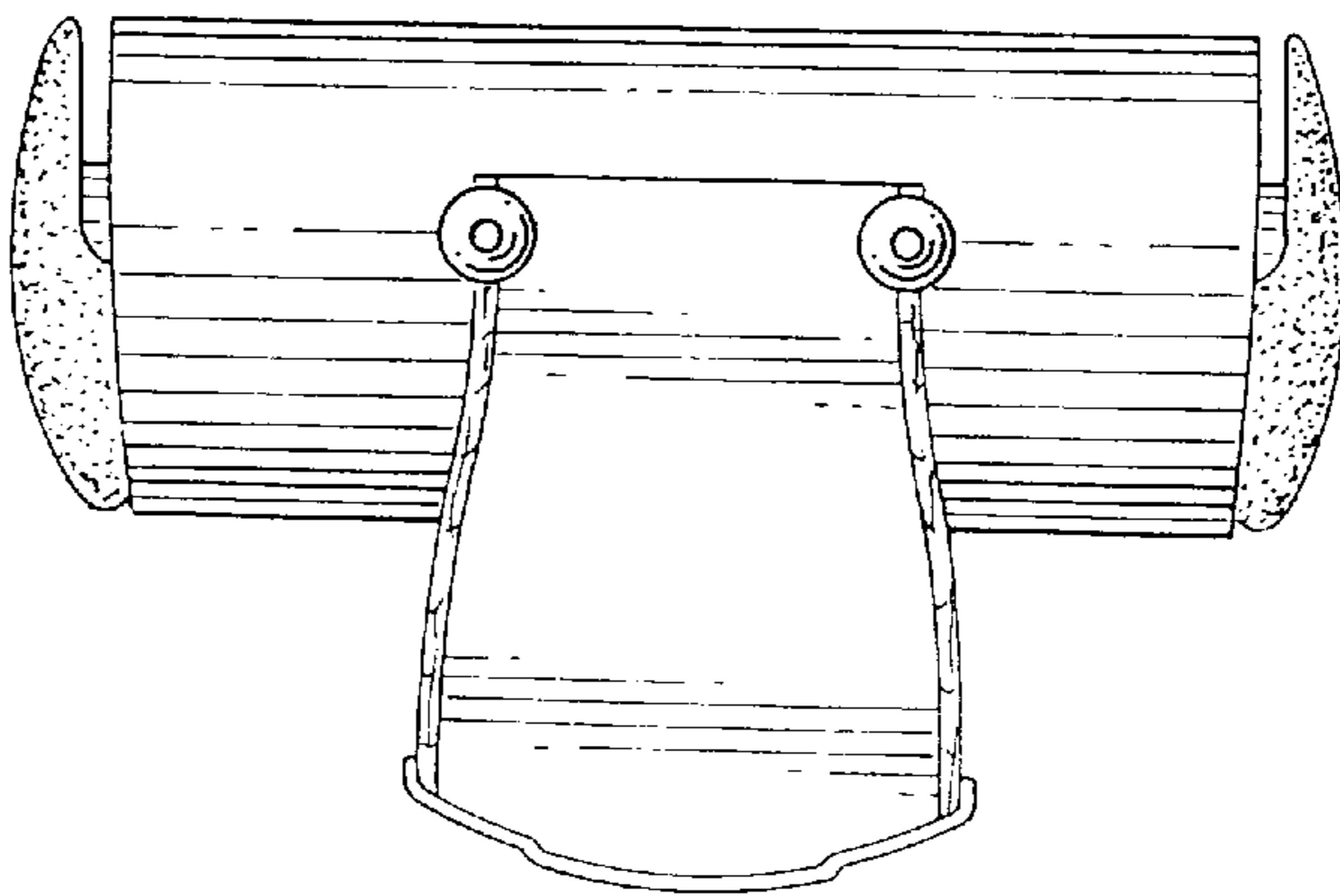

FIG. 11.

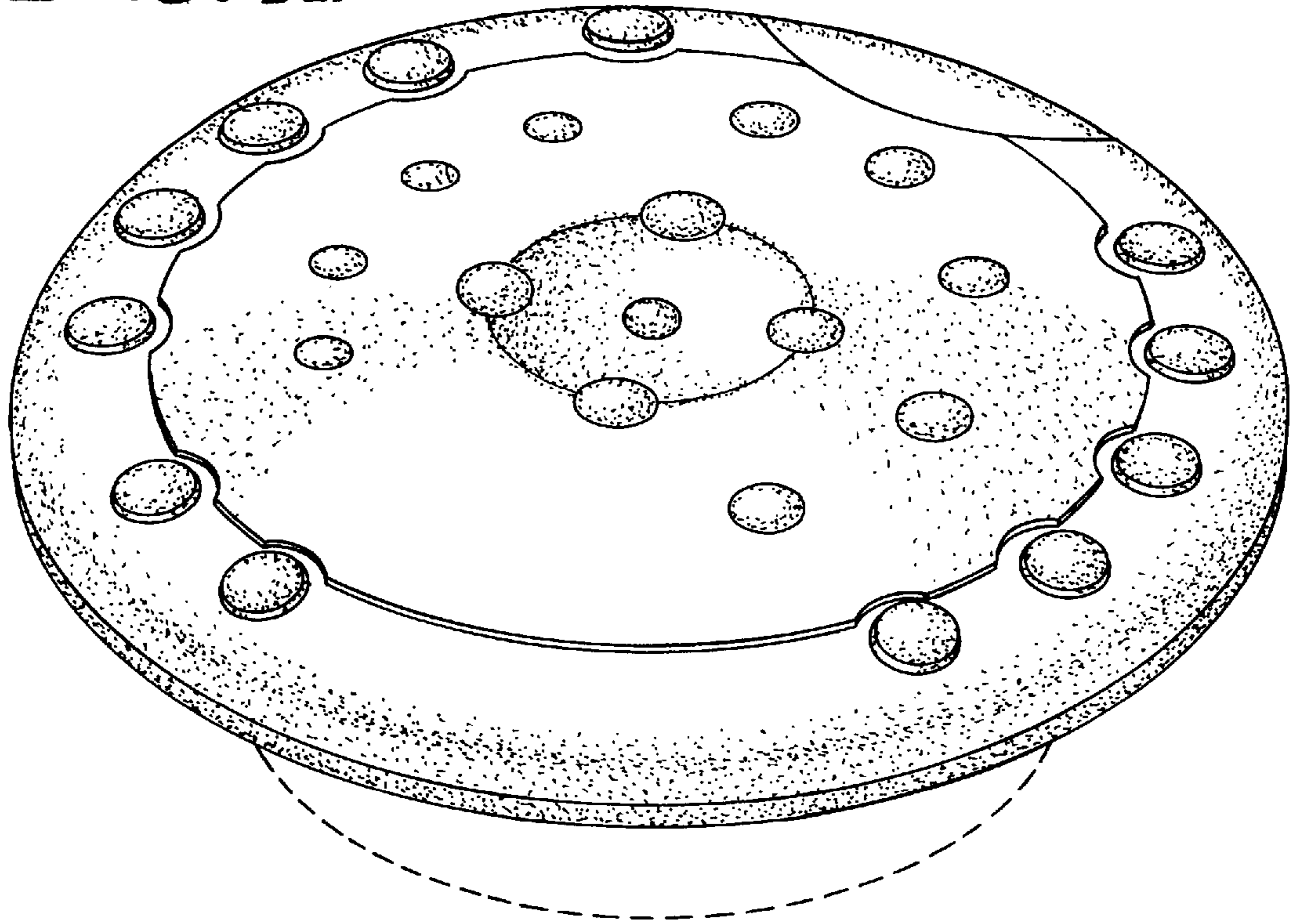

FIG. 12.

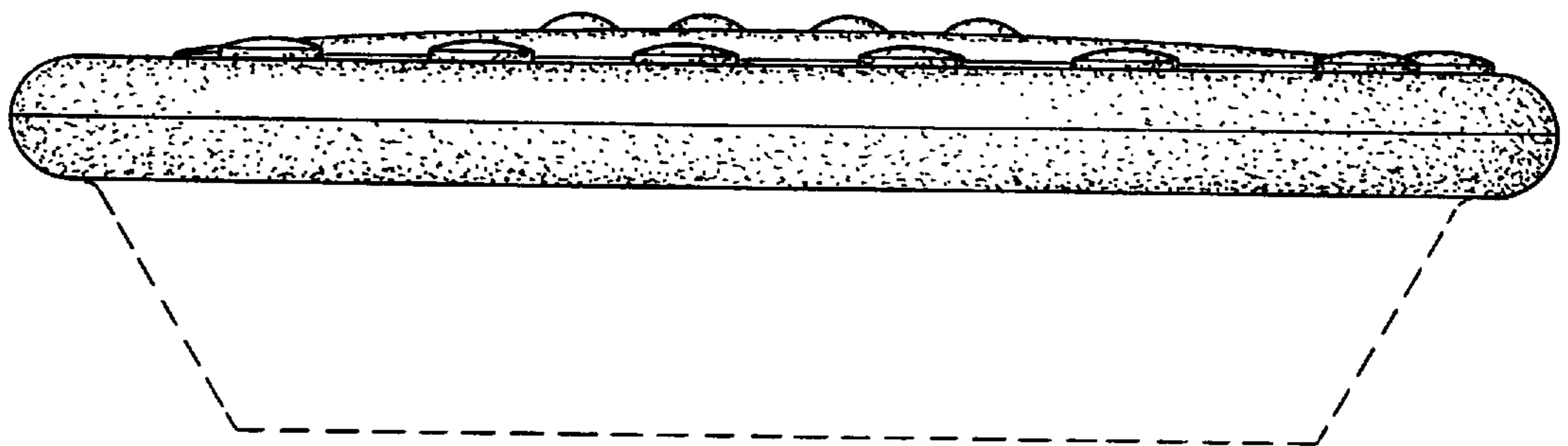

FIG. 13.

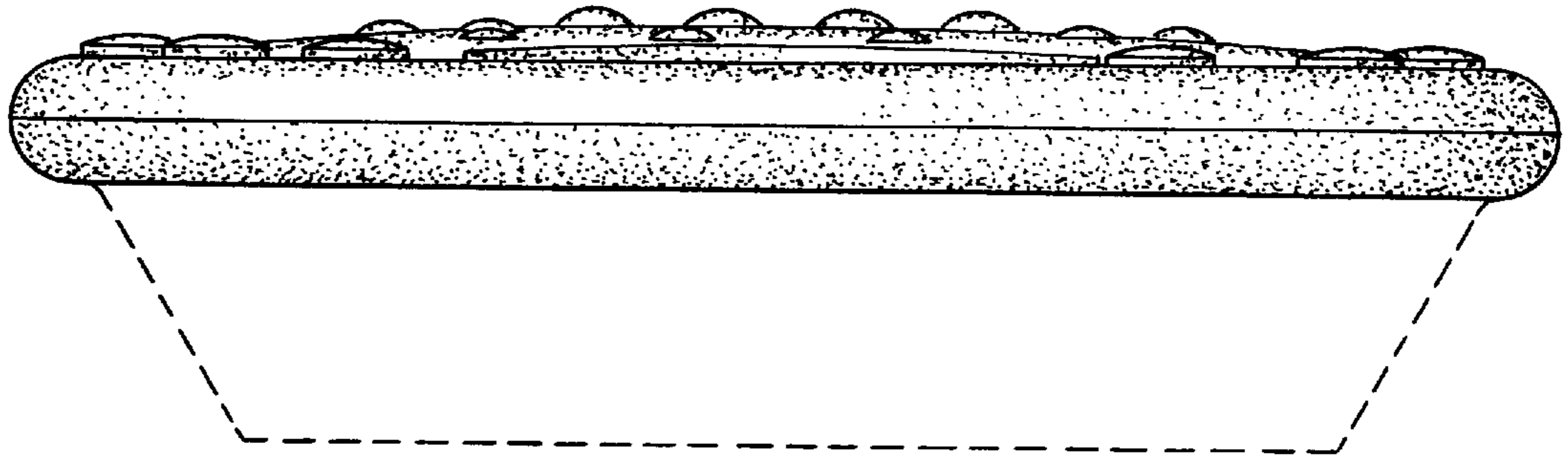

FIG. 14.

