



US00D400505S

United States Patent [19] Yu

[11] **Patent Number: Des. 400,505**

[45] **Date of Patent: **Nov. 3, 1998**

[54] **RECEPTACLE**

D. 379,965 6/1997 Parshad D13/139.6

[75] Inventor: **Tsung-I Yu**, Ban Chyau, Taiwan

Primary Examiner—Susan J. Lucas
Assistant Examiner—Jennifer Rivard
Attorney, Agent, or Firm—Bacon & Thomas

[73] Assignee: **San Shih Electrical Enterprise Co., Ltd.**, Taipei Hsien, Taiwan

[**] Term: **14 Years**

[57] CLAIM

[21] Appl. No.: **75,250**

The ornamental design for a receptacle, as shown and described.

[22] Filed: **Aug. 27, 1997**

DESCRIPTION

[51] **LOC (6) Cl.** **13-03**

FIG. 1 is a top, left front perspective view of a receptacle showing my new design;

[52] **U.S. Cl.** **D13/139.6; D13/139.8**

FIG. 2 is a front elevational view thereof;

[58] **Field of Search** D13/137.1–137.4,
D13/139.1–139.8, 146–147; 439/620, 214,
215, 622, 638, 650, 651, 76.1, 652, 653,
107, 502, 535; 307/141; 200/51.11; 361/115,
118, 119, 56

FIG. 3 is a rear elevational view thereof;

FIG. 4 is a left side elevational view thereof;

FIG. 5 is a right side elevational view thereof;

FIG. 6 is a top plan view thereof;

FIG. 7 is a bottom plan view thereof; and,

FIG. 8 is a top, left front perspective view thereof; and The broken line disclosure is shown for illustrative purposes only and forms no part of the claimed design.

[56] References Cited

U.S. PATENT DOCUMENTS

D. 285,065 8/1986 Bobrovniczky D13/139.8

1 Claim, 5 Drawing Sheets

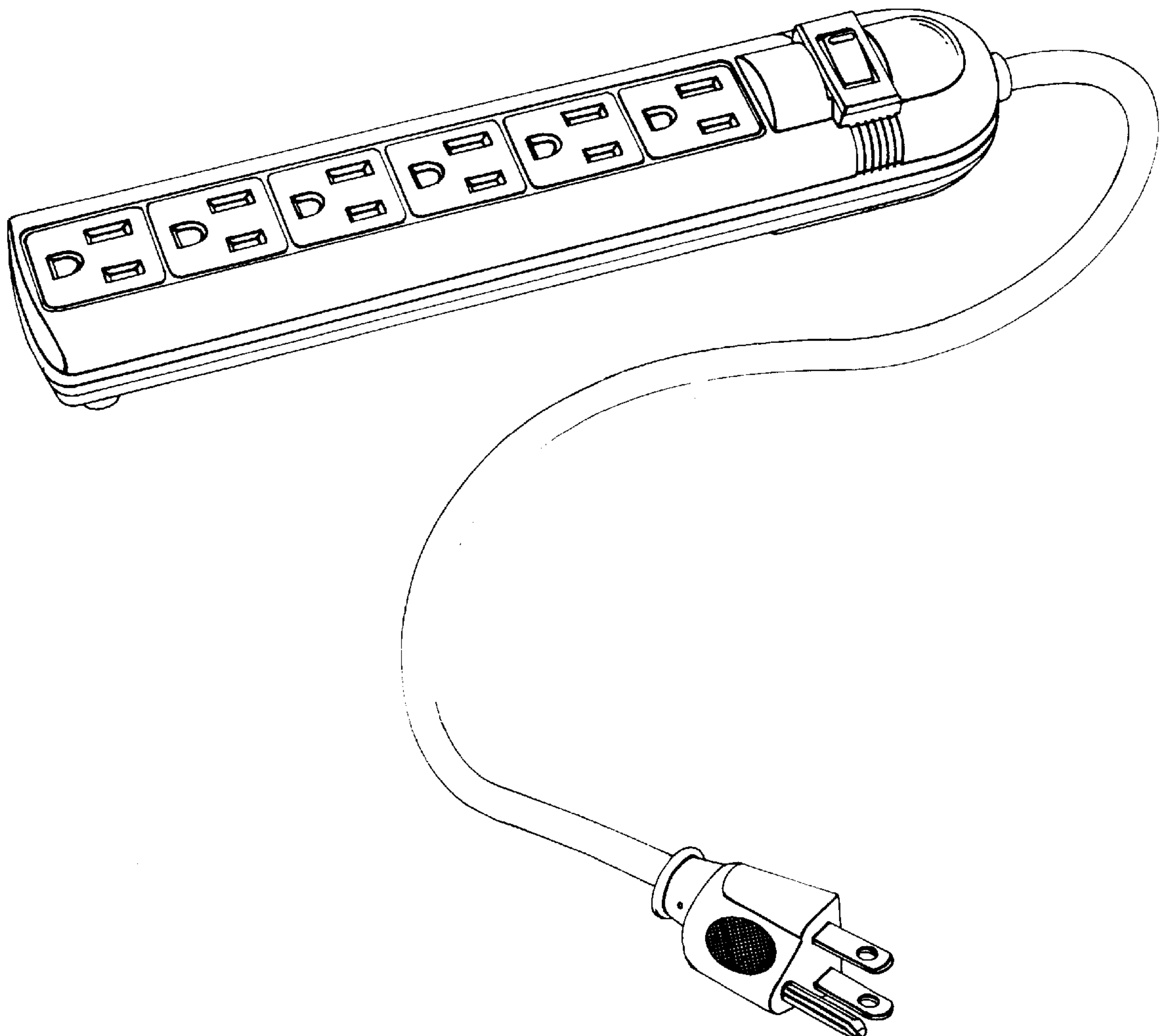

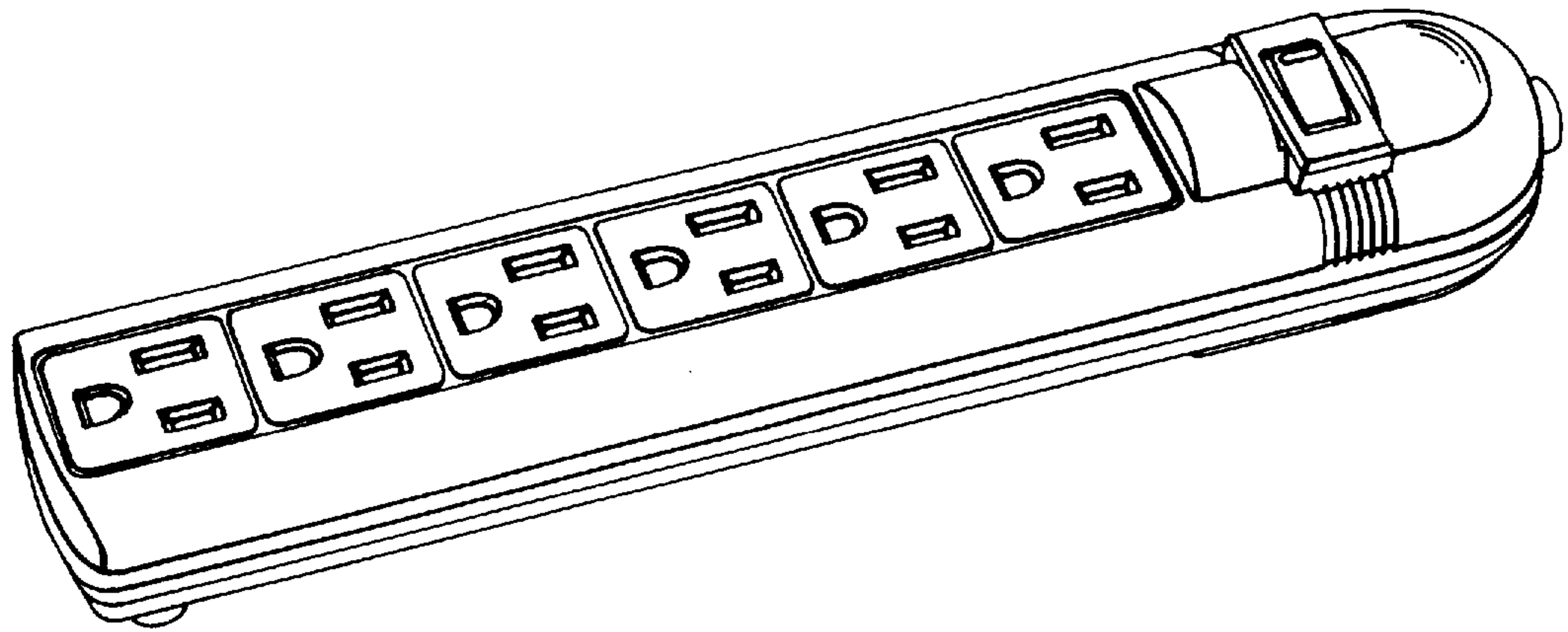

FIG. 1

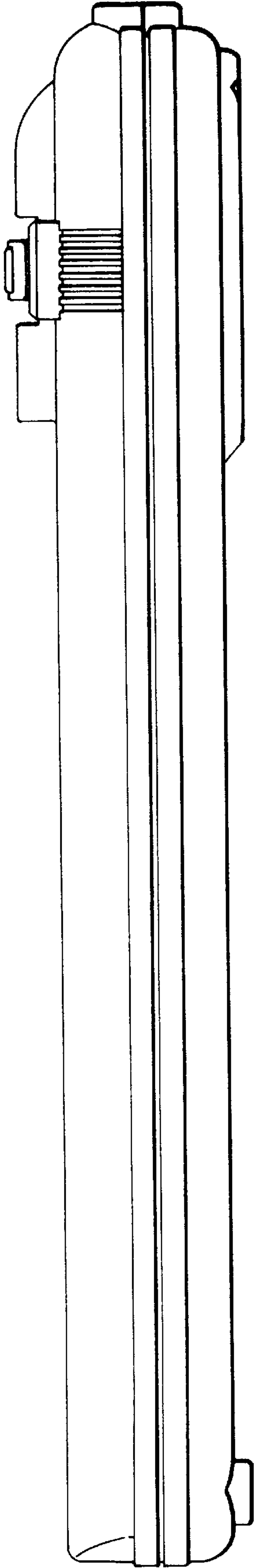

FIG. 2

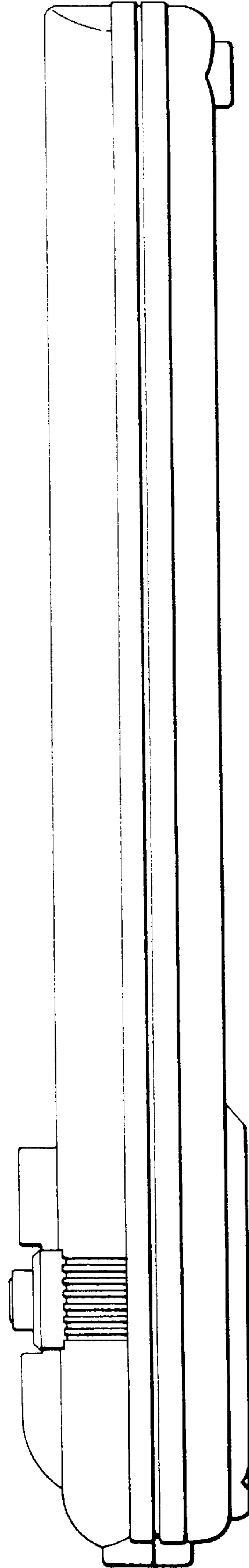

FIG. 3

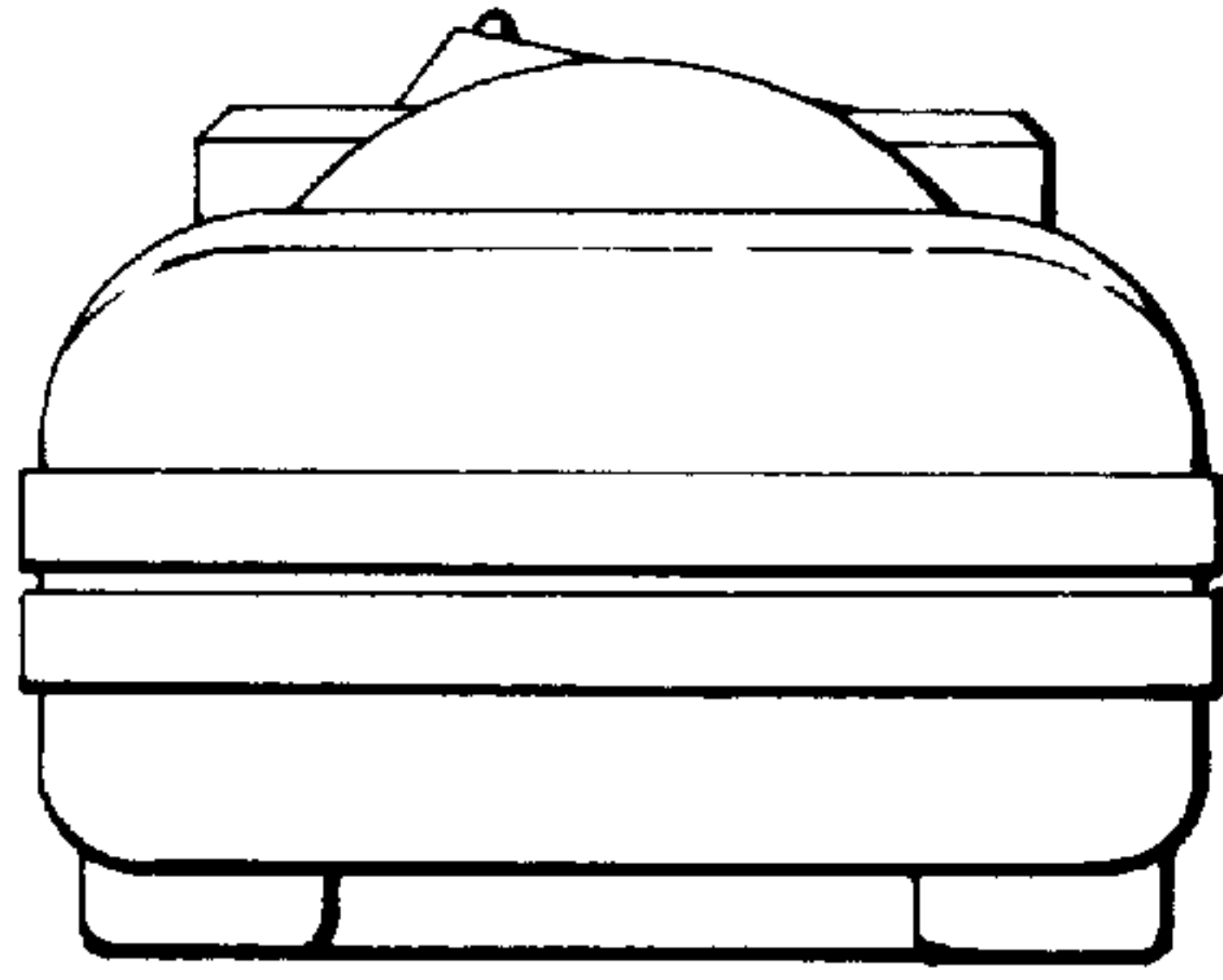

FIG. 4

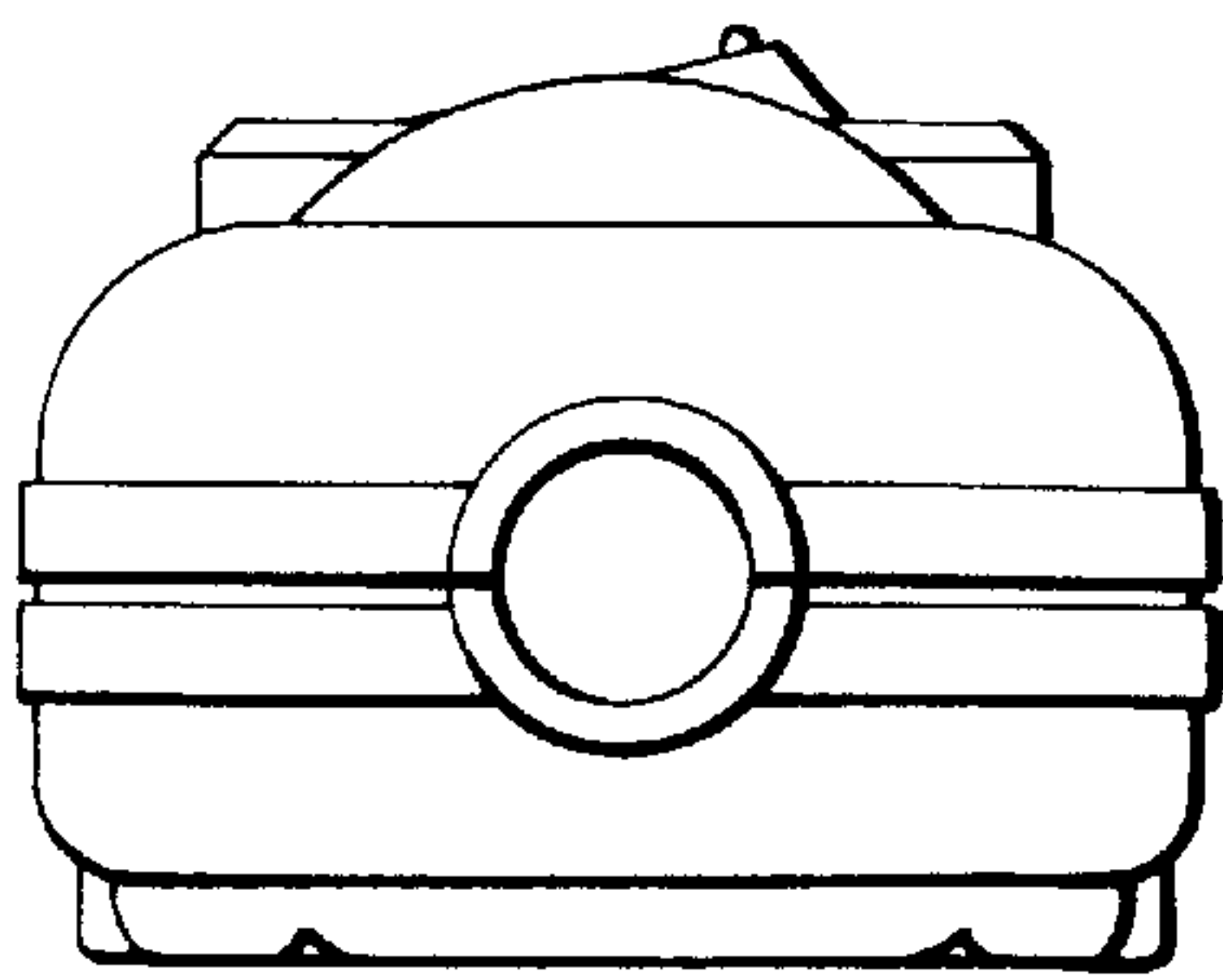

FIG. 5

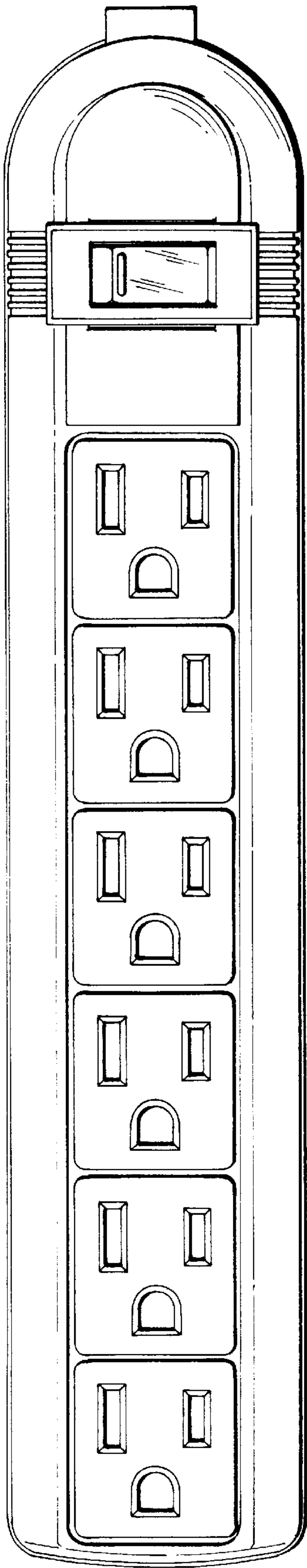

FIG. 6

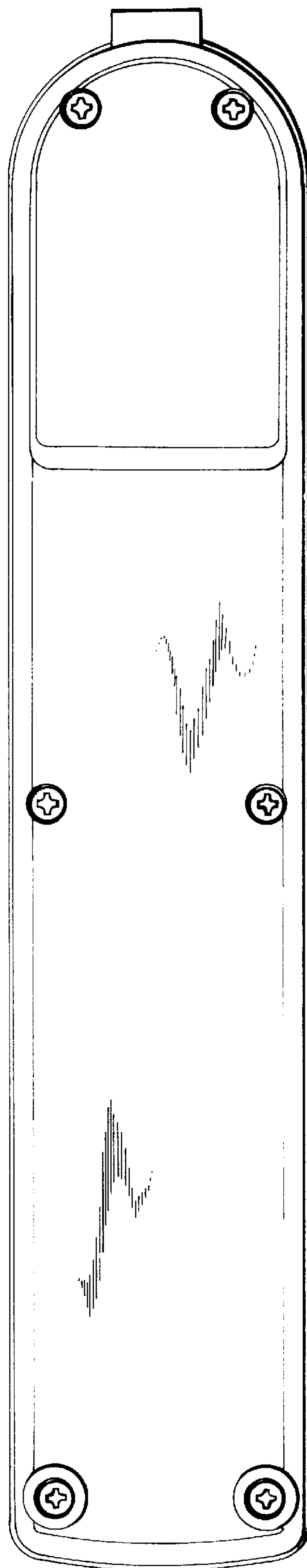

FIG. 7

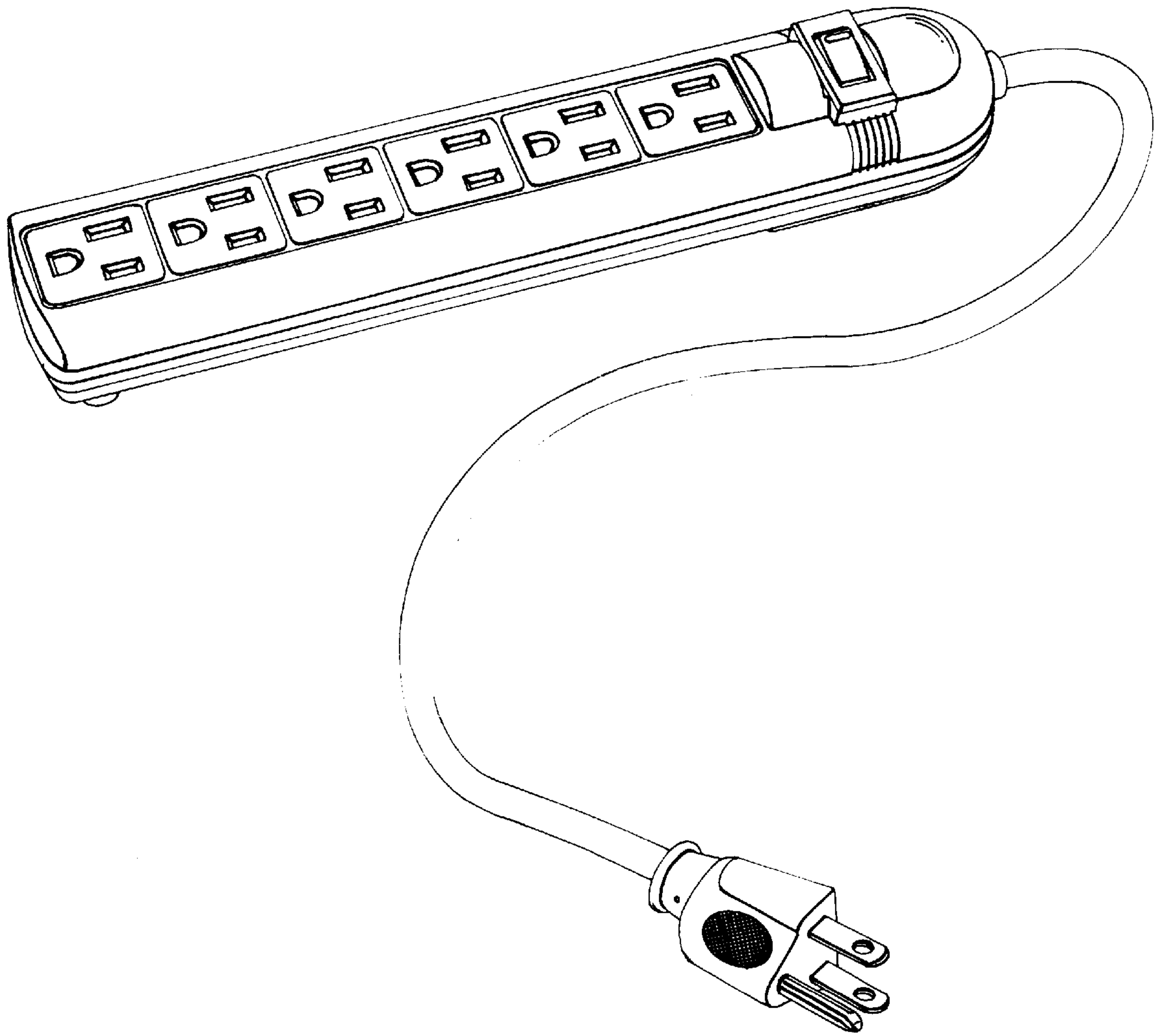

FIG. 8