



US00D400445S

United States Patent [19]
Voegeli

[11] **Patent Number: Des. 400,445**
[45] **Date of Patent: **Nov. 3, 1998**

[54] **WATCH AND STRAP COMBINATION**

OTHER PUBLICATIONS

[75] Inventor: **Michel Voegeli**, Anieres, Switzerland

Hong Kong Enterprise—Jul. 1987 p. n/a two watches at bottom-left.

[73] Assignee: **Christian Dior Couture, S.A.**, Paris, France

Swiss Watch & Jewelry Journal—Feb. 1986 p. 177 watches.
Swiss Watch & Jewelry Journal—Mar. 1987 p. 522—watch at top-left.

[**] Term: **14 Years**

Primary Examiner—Nelson C. Holtje
Attorney, Agent, or Firm—Amster, Rothstein & Ebenstein

[21] Appl. No.: **76,315**

[22] Filed: **Sep. 8, 1997**

[57] **CLAIM**

[30] **Foreign Application Priority Data**

The ornamental design for a watch and strap combination, as shown and described.

Mar. 13, 1997 [WO] WIPO DM/040645

DESCRIPTION

[51] **LOC (6) Cl.** **10-02**

FIG. 1 is a top plan view of the watch and strap combination;
FIG. 2 is a bottom plan view thereof;
FIG. 3 is a right side elevational view thereof;
FIG. 4 is a left side elevational view thereof;
FIG. 5 is a right side perspective view thereof;
FIG. 6 is a front elevational view thereof; and,
FIG. 7 is a rear elevational view thereof.

[52] **U.S. Cl.** **D10/32; D10/30**

[58] **Field of Search** D10/1-40, 122-132;
368/280-282, 276-277, 285

[56] **References Cited**

U.S. PATENT DOCUMENTS

D. 324,828 3/1992 Winderman D10/32
D. 359,457 6/1995 Visage D10/30

1 Claim, 7 Drawing Sheets

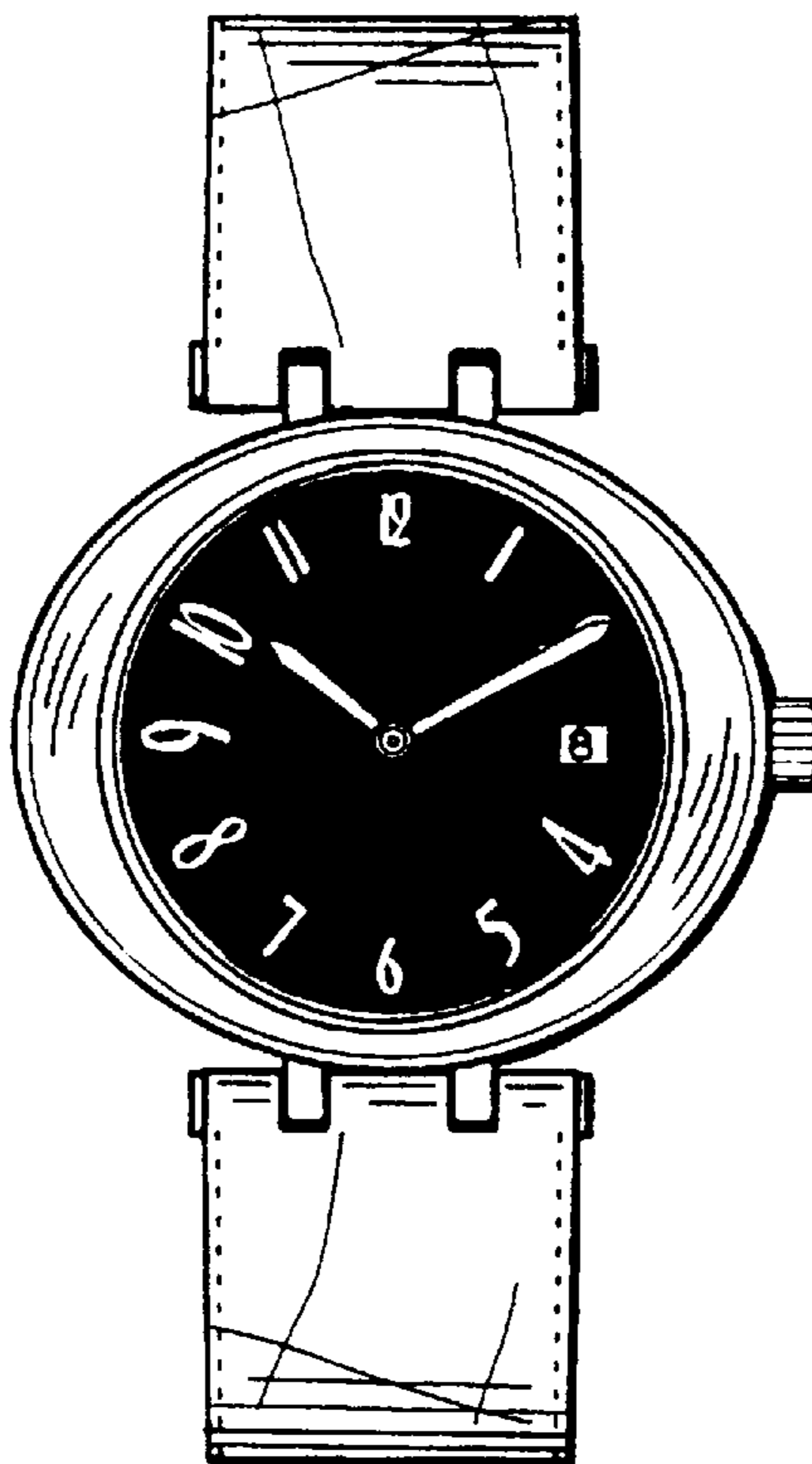

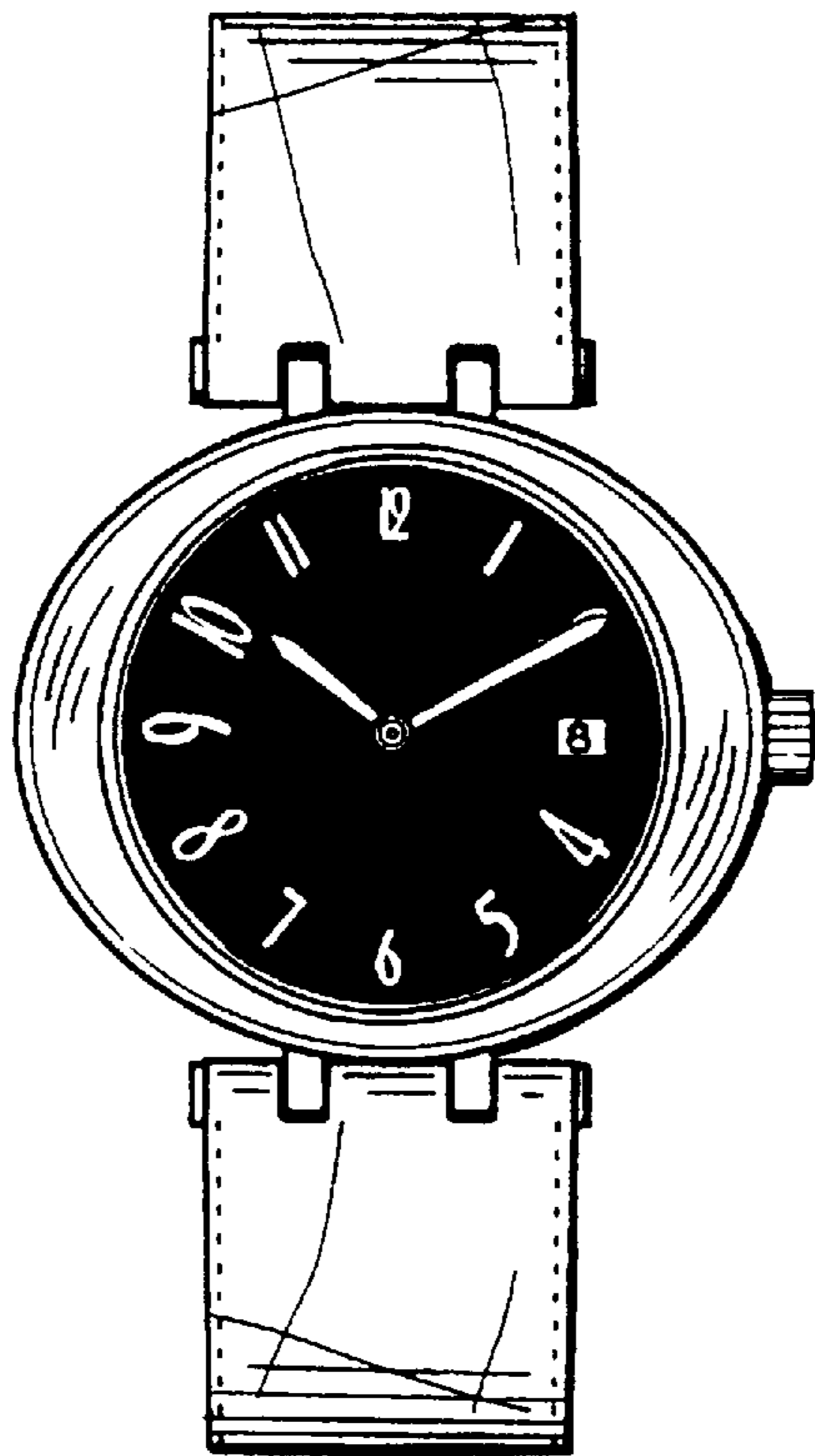

FIG. 1

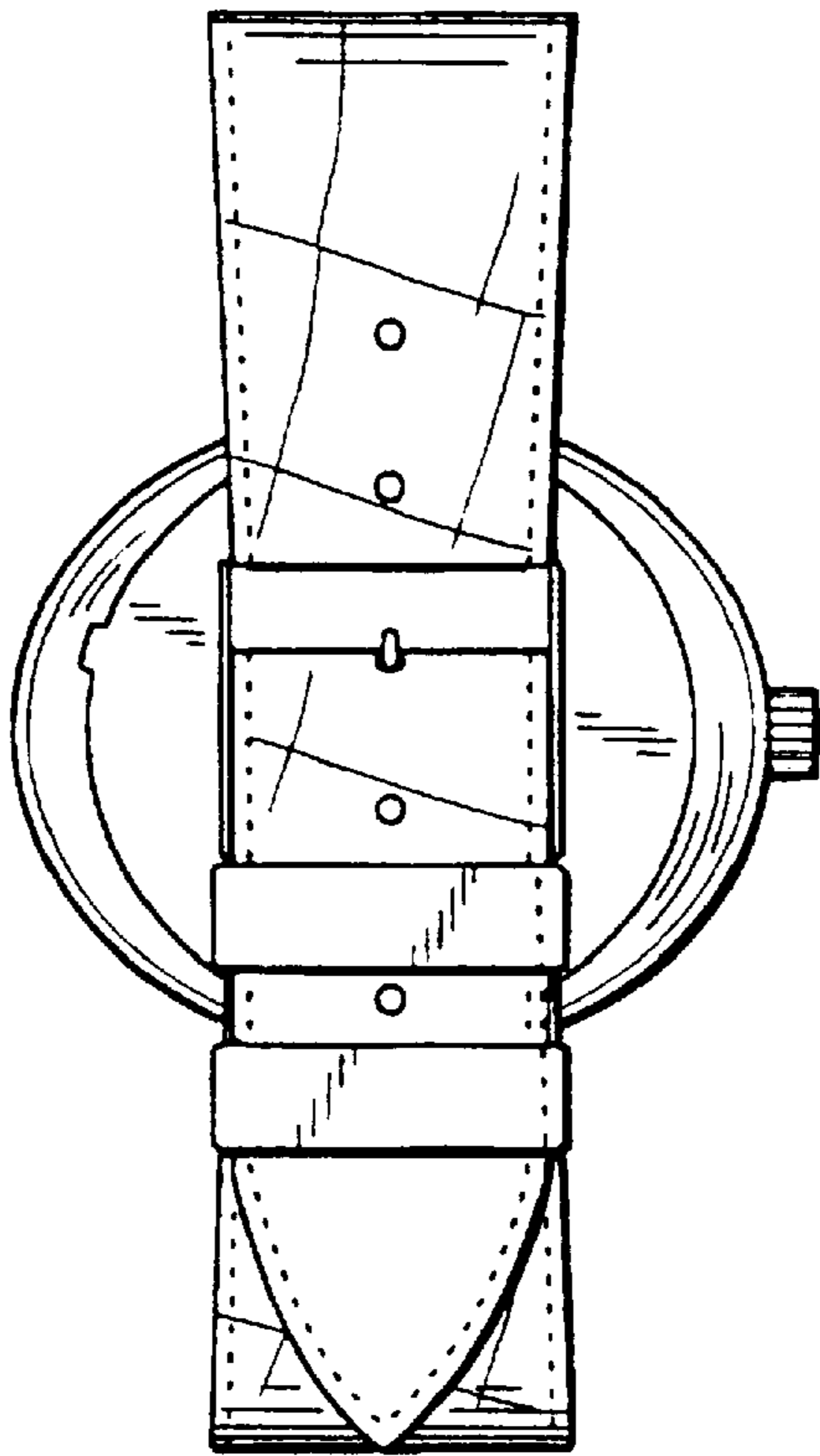

FIG. 2

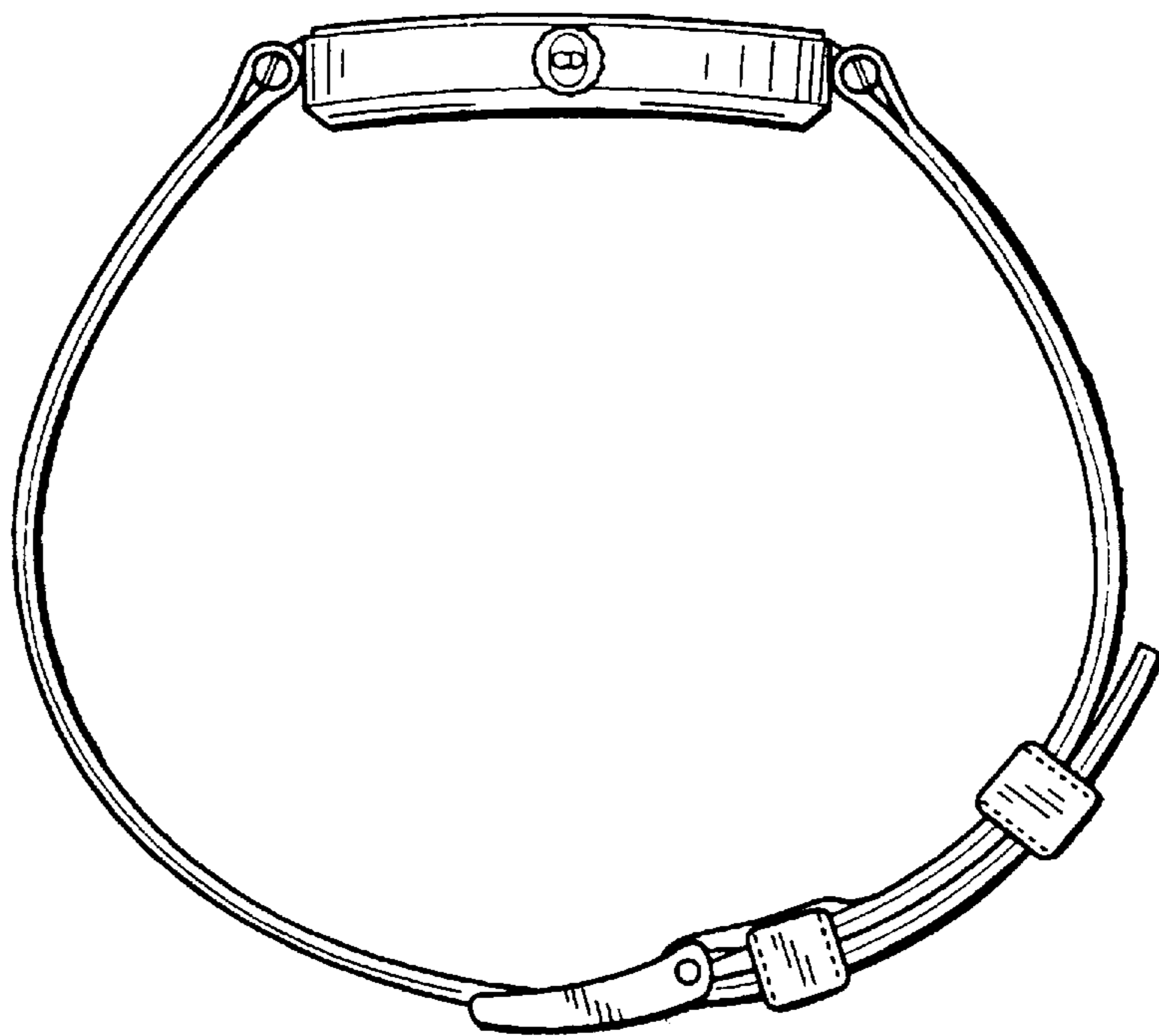

FIG. 3

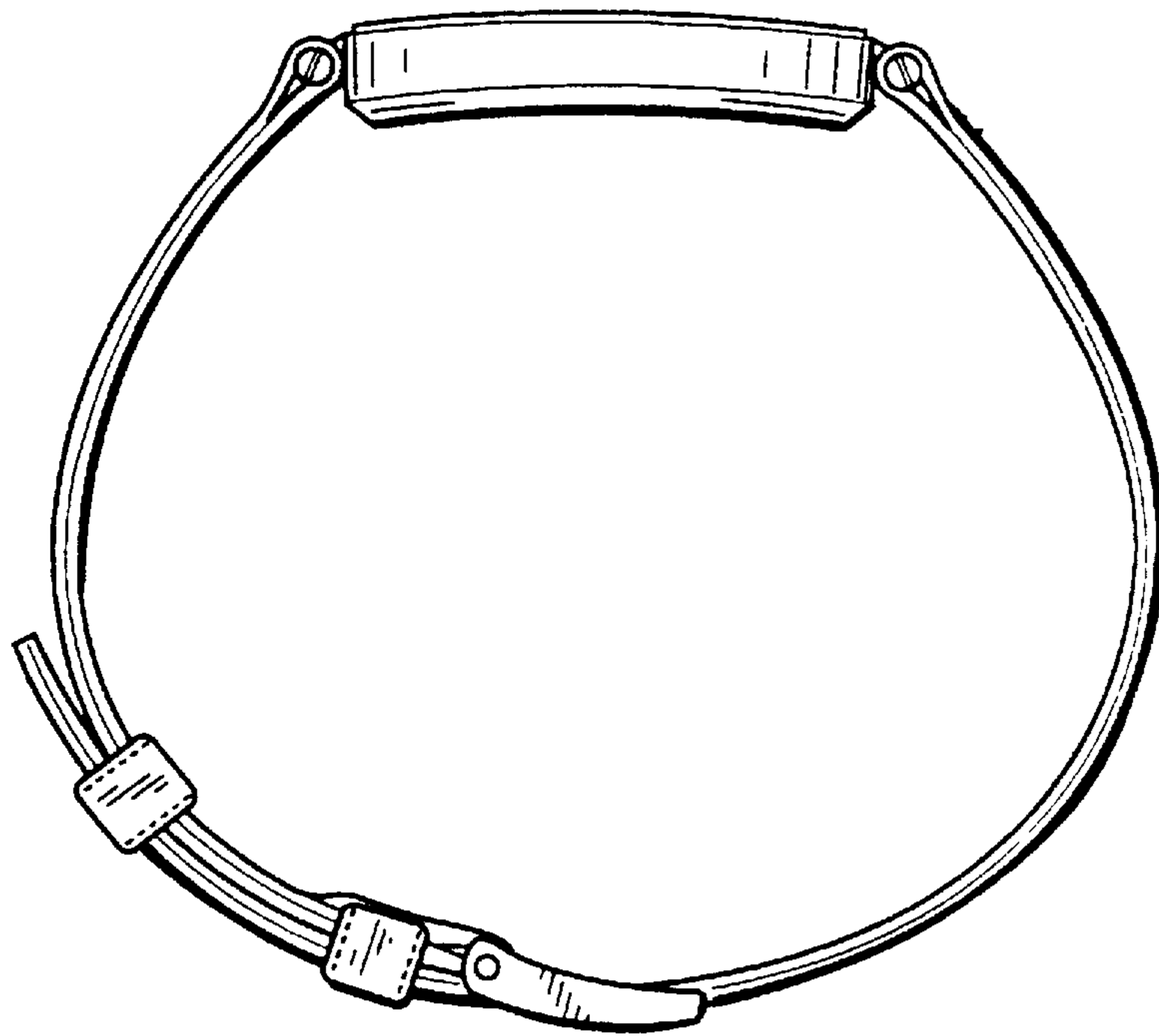

FIG. 4

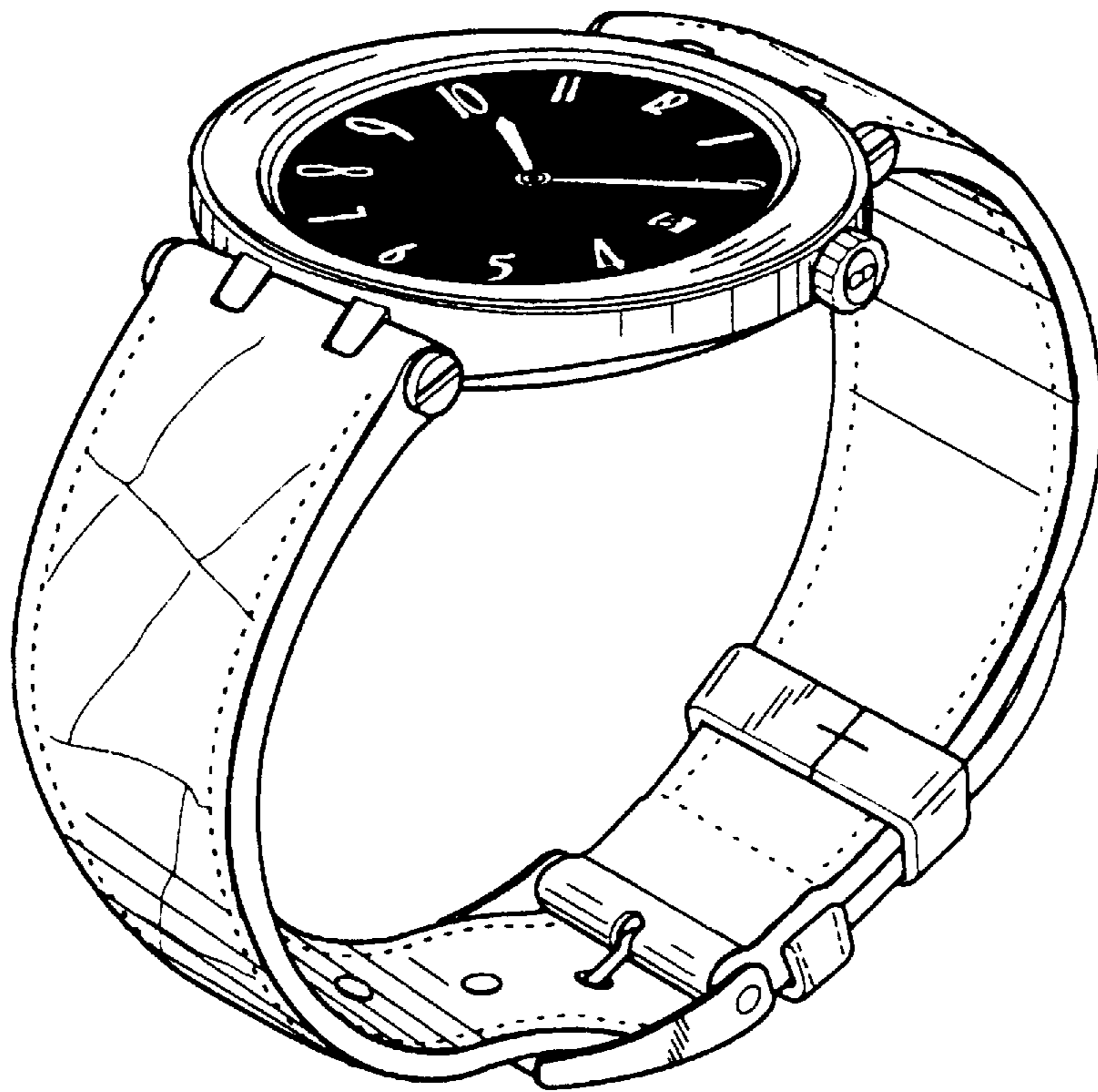

FIG. 5

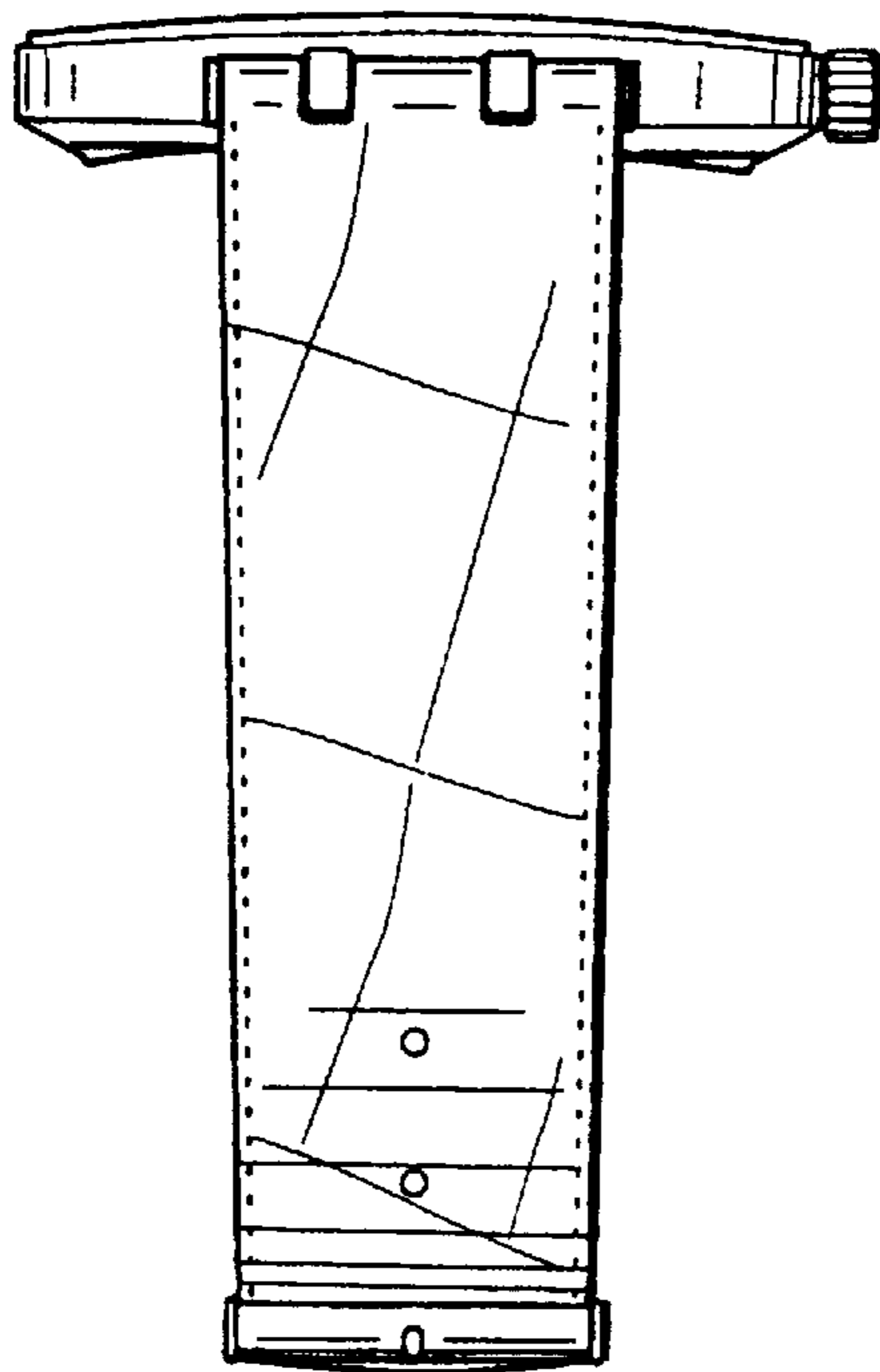

FIG. 6

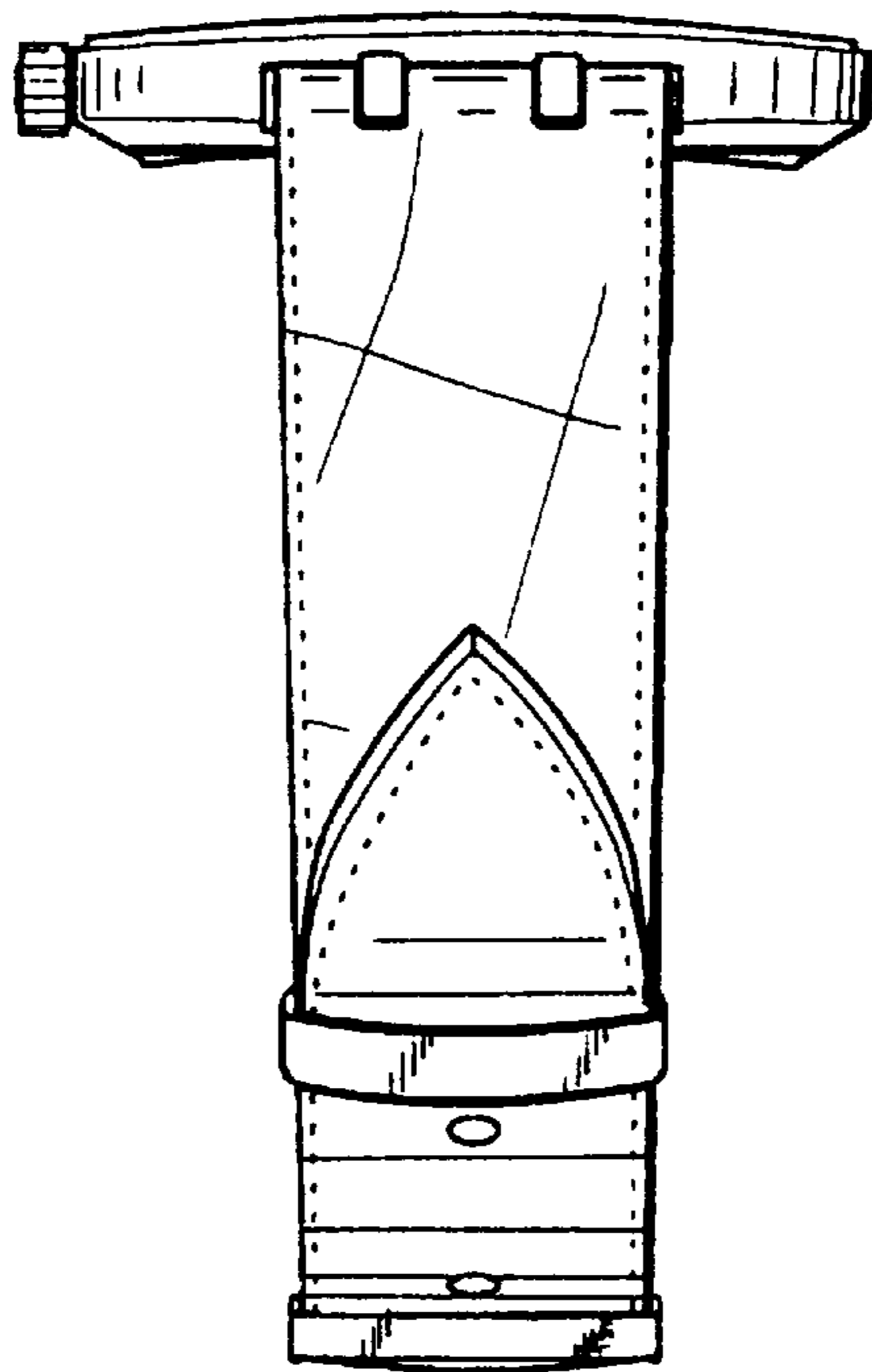

FIG. 7