



US00D400393S

United States Patent [19]
Ranzoni

[11] **Patent Number: Des. 400,393**
[45] **Date of Patent: **Nov. 3, 1998**

[54] **POT WITH COVER**

[75] Inventor: **Francesco Ranzoni**, Chiari-Brescia, Italy

[73] Assignee: **Rondine Italia S.p.A.**, Brescia, Italy

[**] Term: **14 Years**

[21] Appl. No.: **69,144**

[22] Filed: **Apr. 2, 1997**

[51] **LOC (6) Cl.** **07-02**

[52] **U.S. Cl.** **D7/360; D7/393**

[58] **Field of Search** **D7/354-361, 391-392.1; 220/912**

[56] **References Cited**

U.S. PATENT DOCUMENTS

- D. 329,570 9/1992 Gerlach D7/354 X
- D. 347,963 6/1994 Pretzsch D7/354 X

Primary Examiner—Caron D. Veynar
Attorney, Agent, or Firm—Fitzpatrick, Cella, Harper & Scinto

[57] **CLAIM**

The ornamental design for pot with cover, as shown and described.

DESCRIPTION

FIG. 1 is a perspective view of an embodiment of the new design;
FIG. 2 is a top plan view of the embodiment of FIG. 1;
FIG. 3 is a bottom plan view of the embodiment of FIG. 1;
FIG. 4 is a side view showing one side of the embodiment of FIG. 1;
FIG. 5 is a side view showing the opposite side of the embodiment of FIG. 1; and,
FIG. 6 is an end view of the embodiment of FIG. 1, the opposite side view is a mirror image thereof.

1 Claim, 6 Drawing Sheets

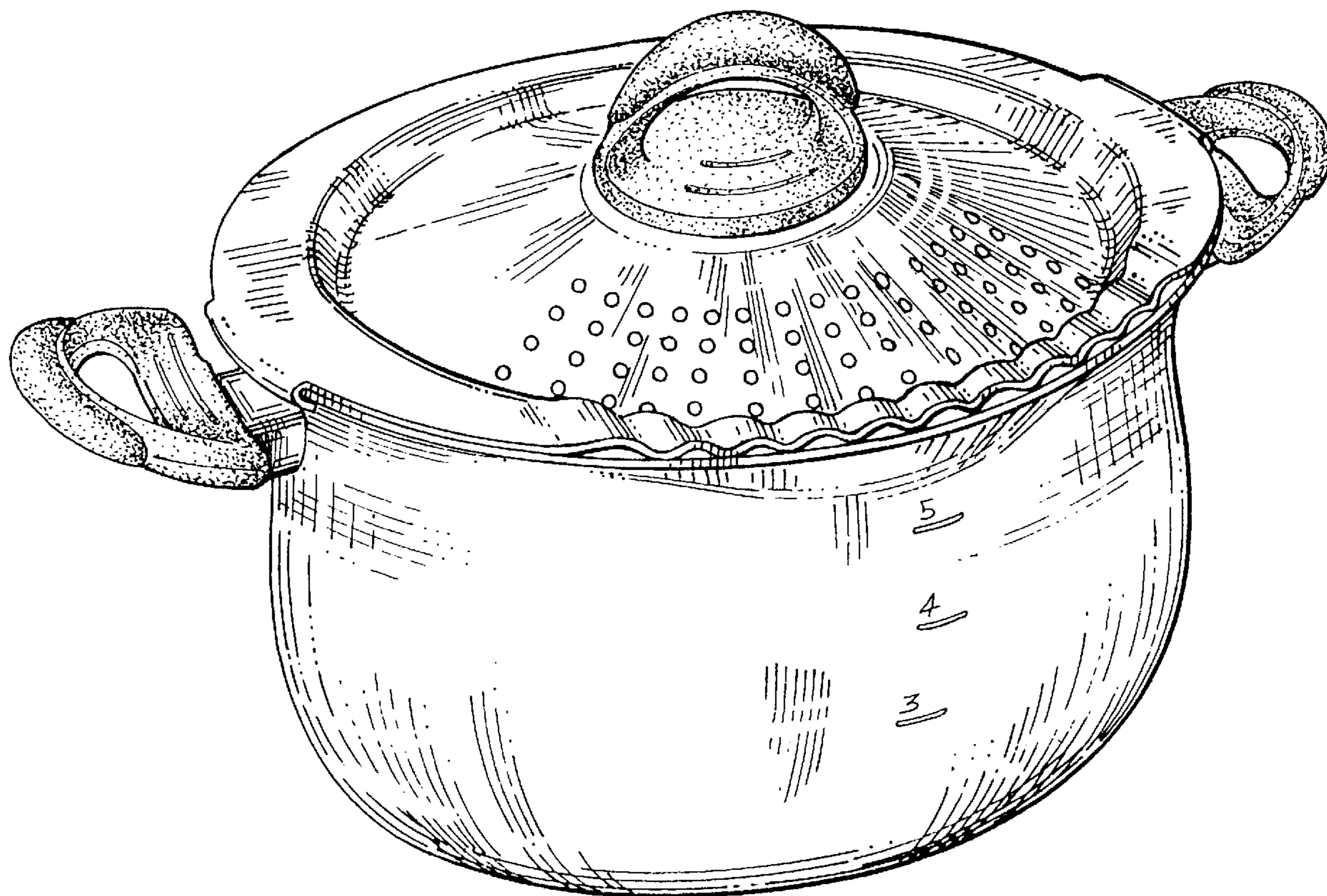

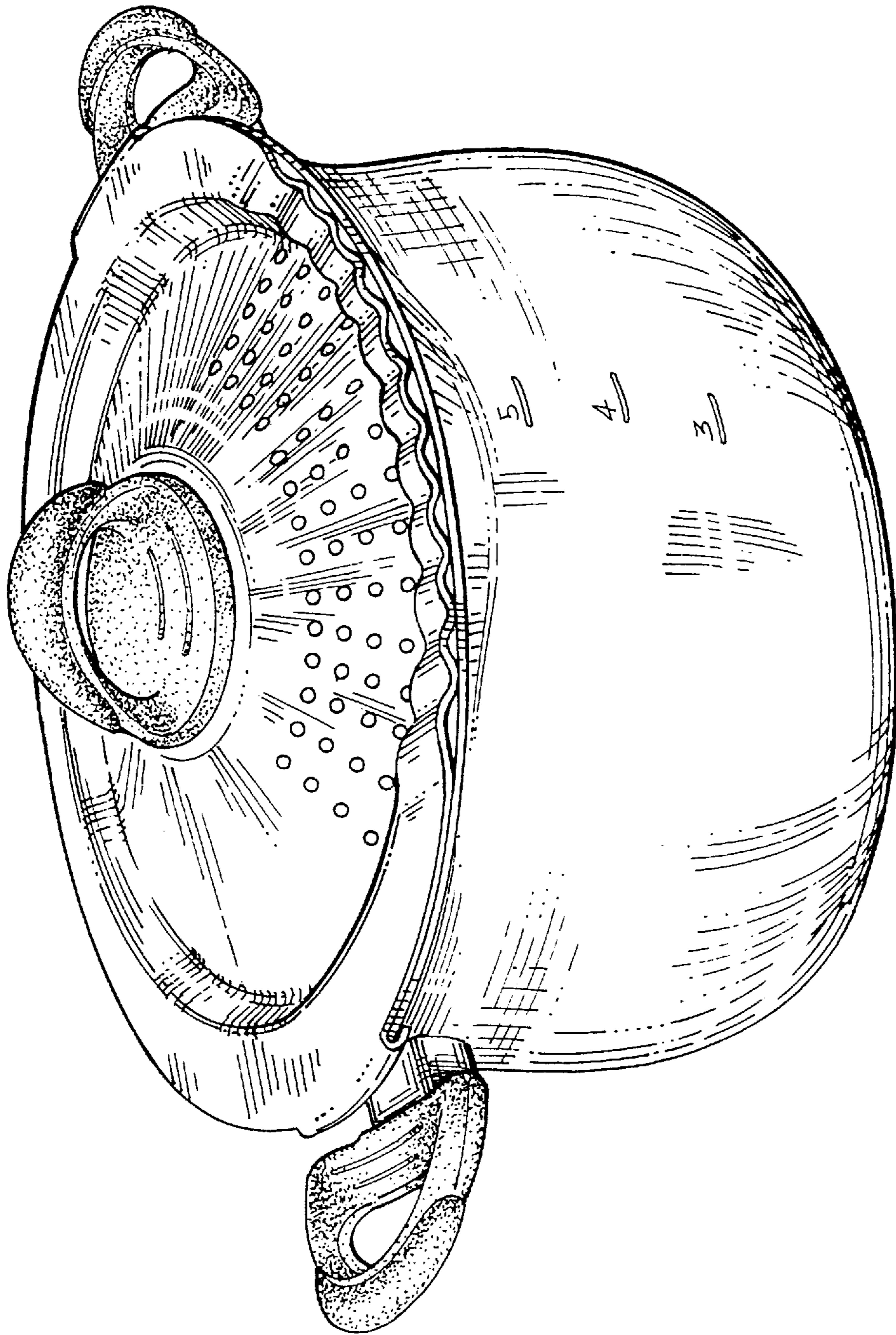

FIG. 1

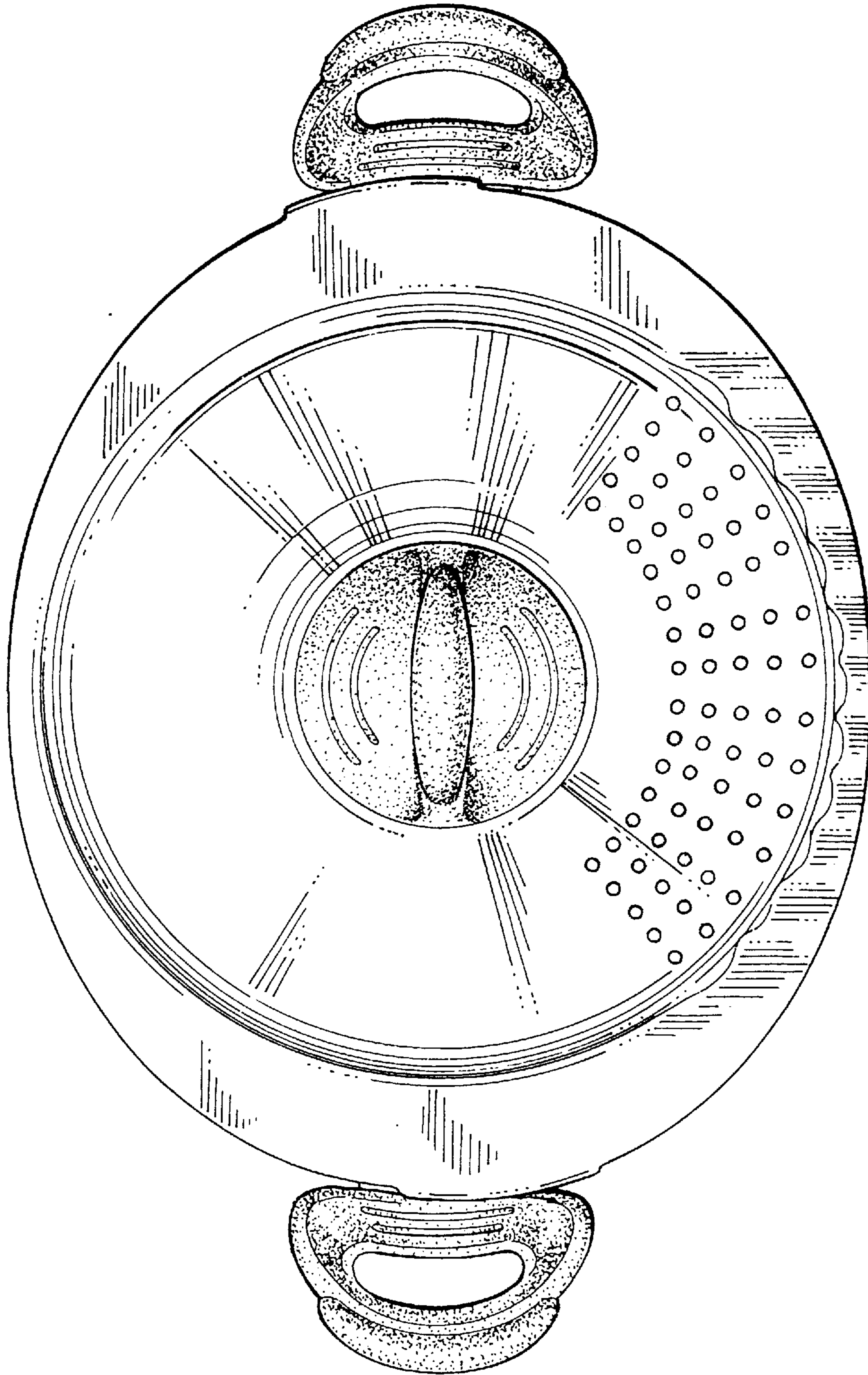

FIG.2

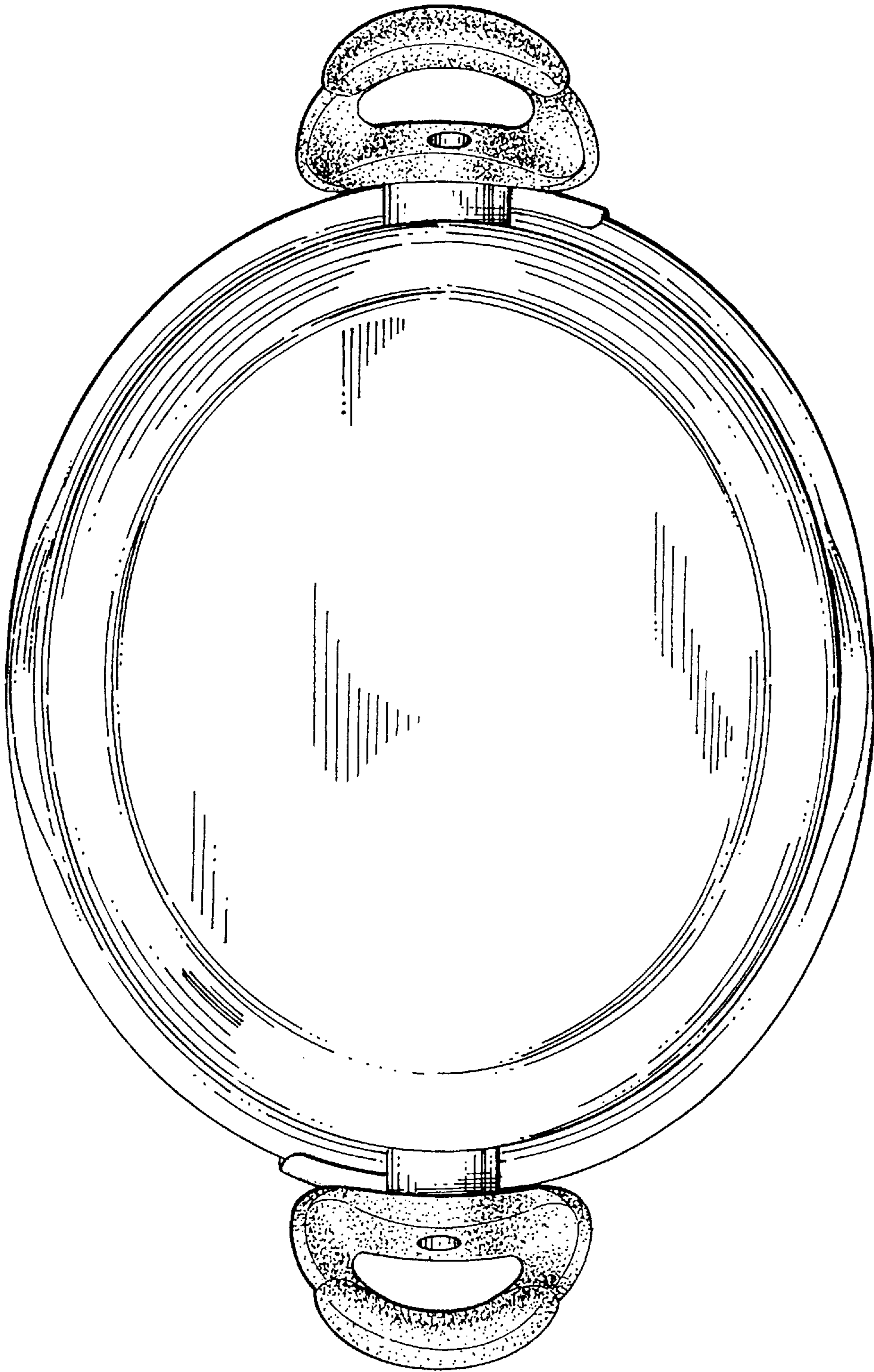

FIG. 3

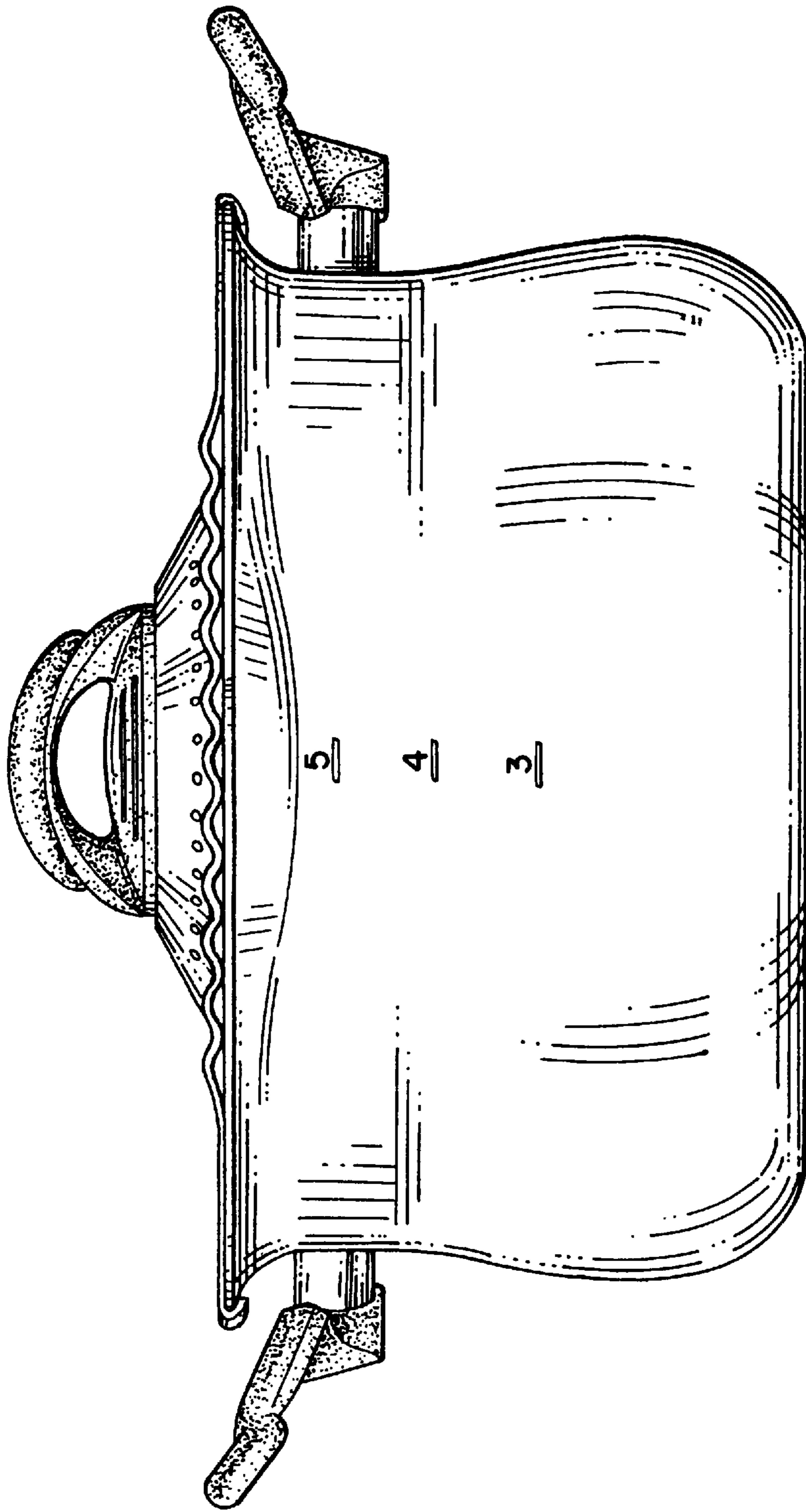

FIG.4

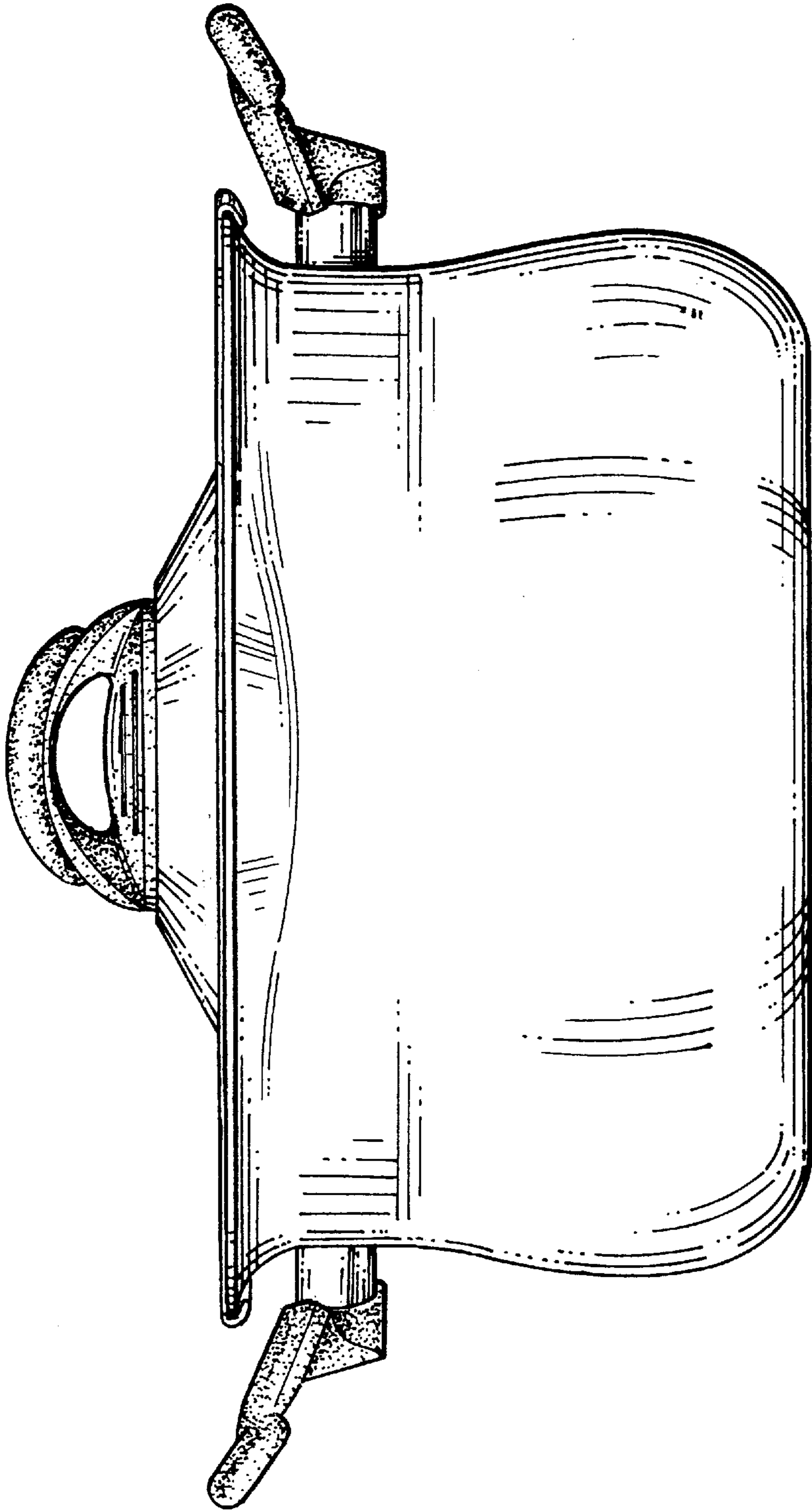

FIG.5

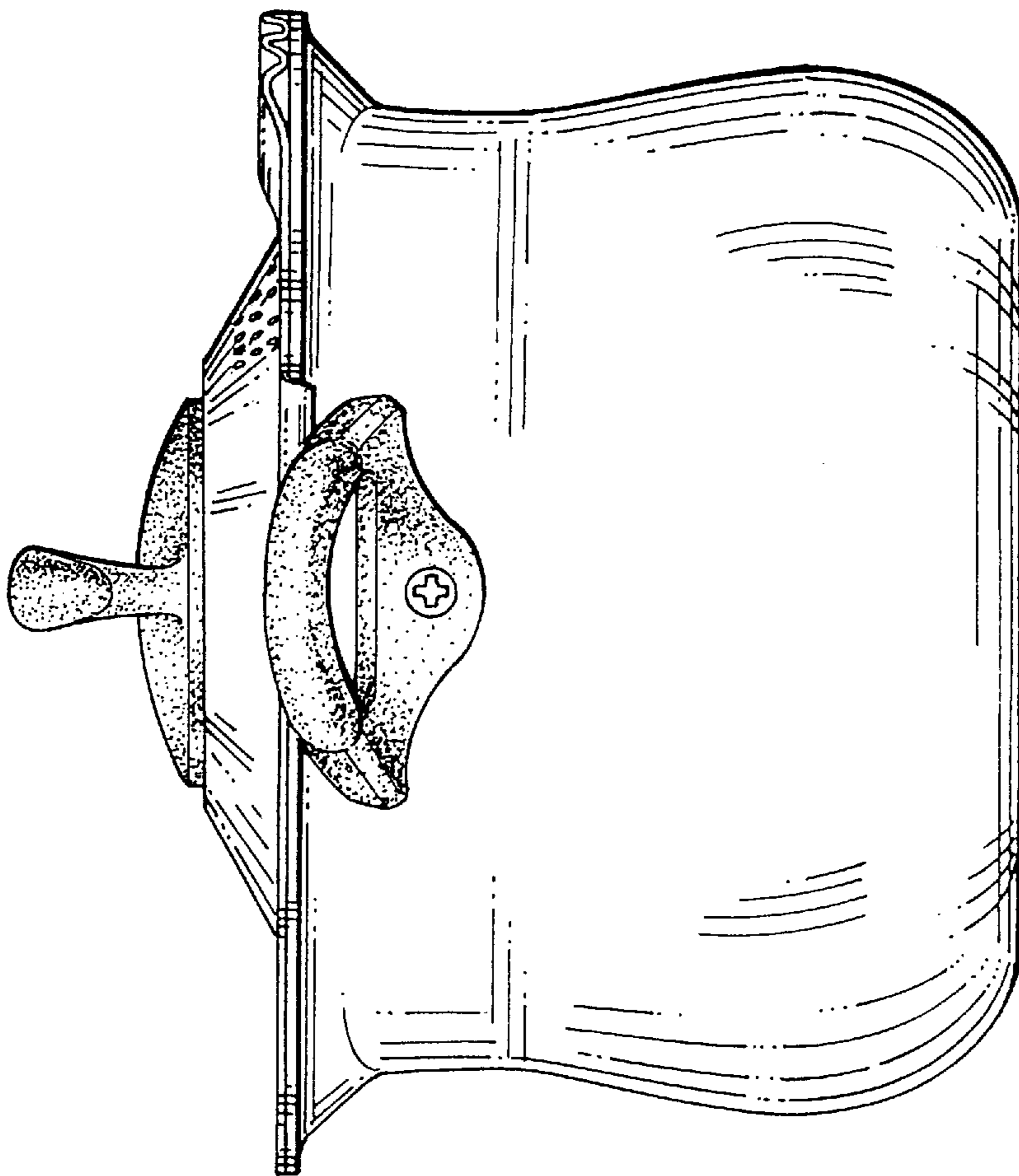

FIG.6