



US00D400328S

United States Patent [19] Zemel

[11] **Patent Number: Des. 400,328**

[45] **Date of Patent: **Oct. 27, 1998**

[54] LONG HANDLE GRILL CLEANER

[75] Inventor: **Marc Zemel**, Old Bethpage, N.Y.

[73] Assignee: **Mr. Bar-B-Q, Inc.**, Old Bethpage, N.Y.

[**] Term: **14 Years**

[21] Appl. No.: **78,116**

[22] Filed: **Oct. 17, 1997**

[51] **LOC (6) Cl. 08-05**

[52] **U.S. Cl. D32/49; D32/42; D4/118**

[58] **Field of Search D32/35, 42, 40, D32/46, 49; 15/104.16, 164, 236.01, 236.09, 166, 105, 105.52, 111, 114, 105.53; D4/116, 118, 132, 119, 120**

[56] **References Cited**

U.S. PATENT DOCUMENTS

D. 337,659	7/1993	Lacy	D4/116
D. 366,962	2/1996	Whitaker	D4/118 X
D. 374,557	10/1996	Whitaker	D4/120
3,199,139	8/1965	Vallis	15/111 X
5,317,779	6/1994	Hoagland	15/236.05 X
5,479,673	1/1996	Carton	15/111

OTHER PUBLICATIONS

Mr. Bar-B-Q Catalog Sheet Item #06005GS ©1996.

Primary Examiner—Susan J. Lucas

Assistant Examiner—Cynthia E. Ramirez

Attorney, Agent, or Firm—Natter & Natter

[57] **CLAIM**

The ornamental design of a long handle grill cleaner, as shown and described.

DESCRIPTION

FIG. 1 is a side elevational view of a long handle grill cleaner showing my new design;

FIG. 2 is a front elevational view thereof;

FIG. 3 is a rear elevational view thereof;

FIG. 4 is a bottom view thereof;

FIG. 5 is a top plan view thereof; and,

FIG. 6 is a perspective view thereof.

The side not illustrated is a mirror image of the side illustrated in FIG. 1.

The broken line showings of a cleaning pad and brush bristles are for illustrative purposes only and form no part of the claimed design.

1 Claim, 3 Drawing Sheets

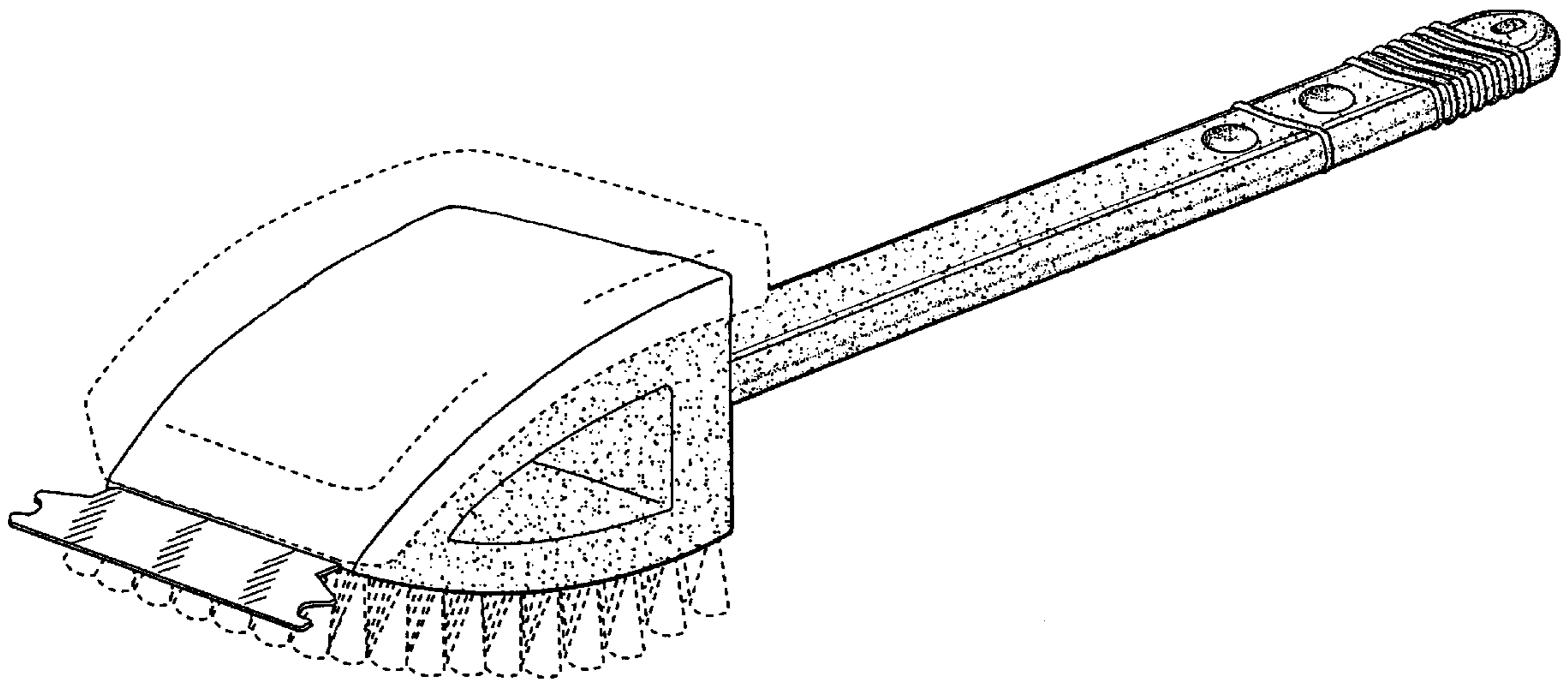

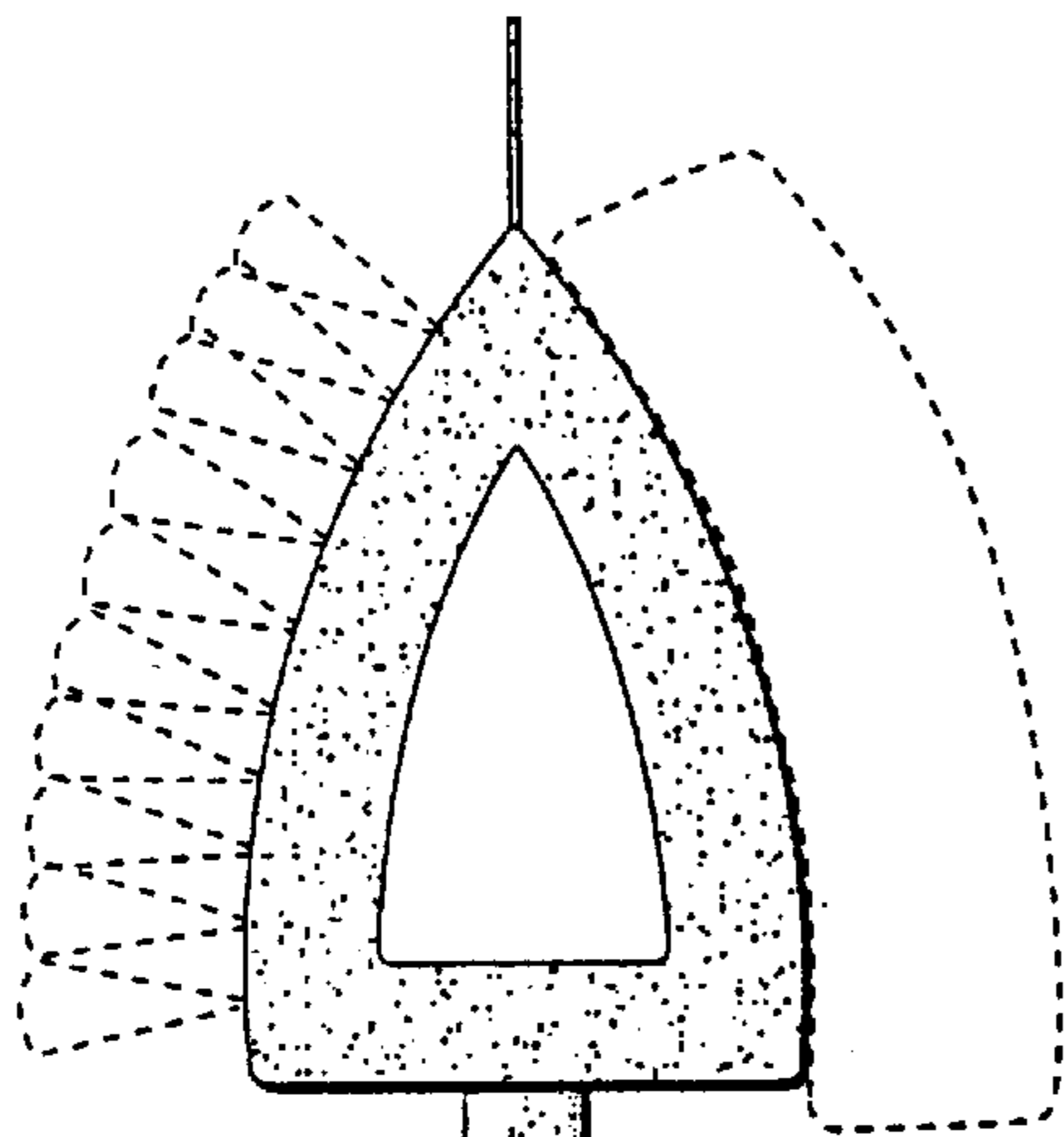

Fig. 1

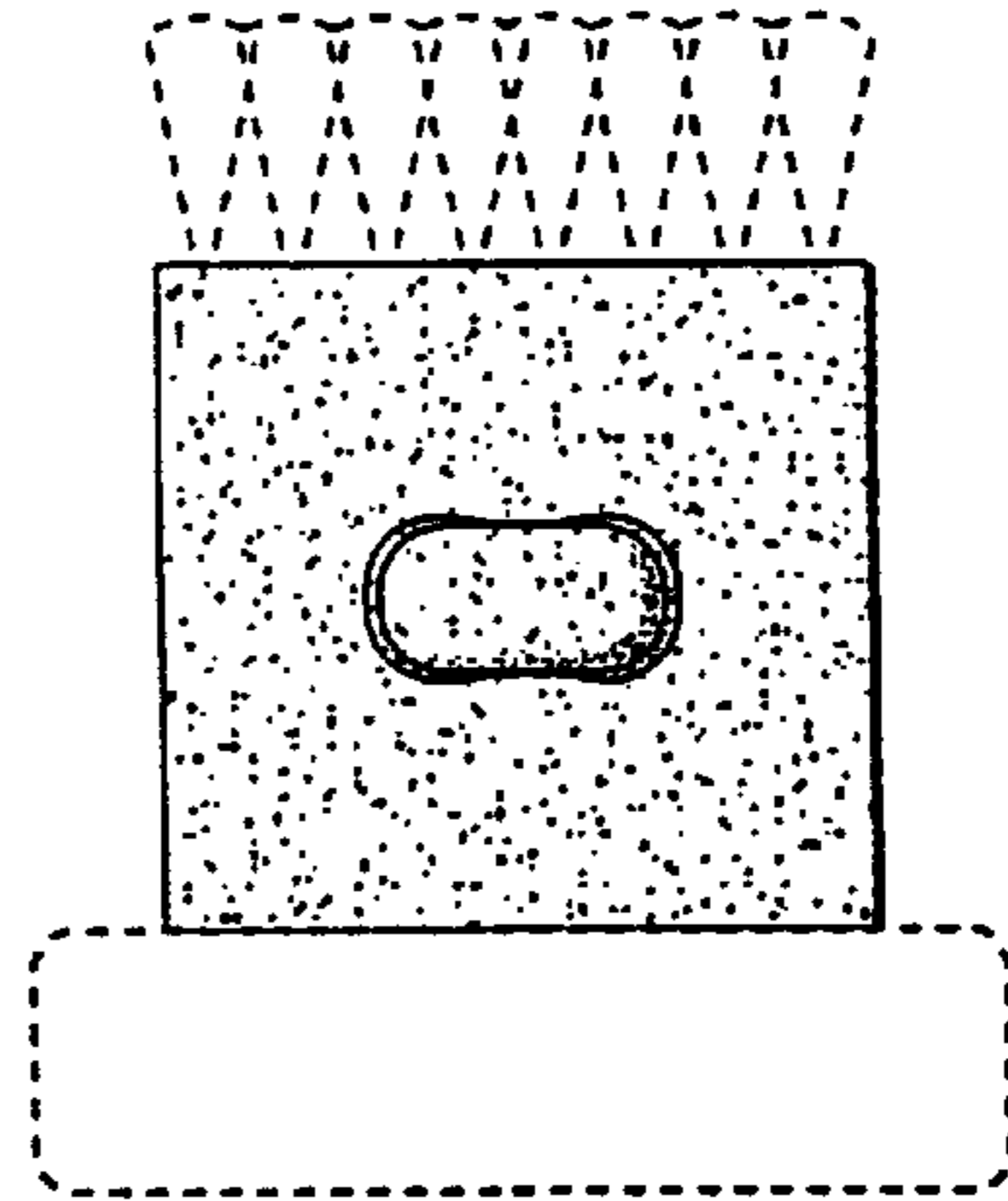

Fig. 4

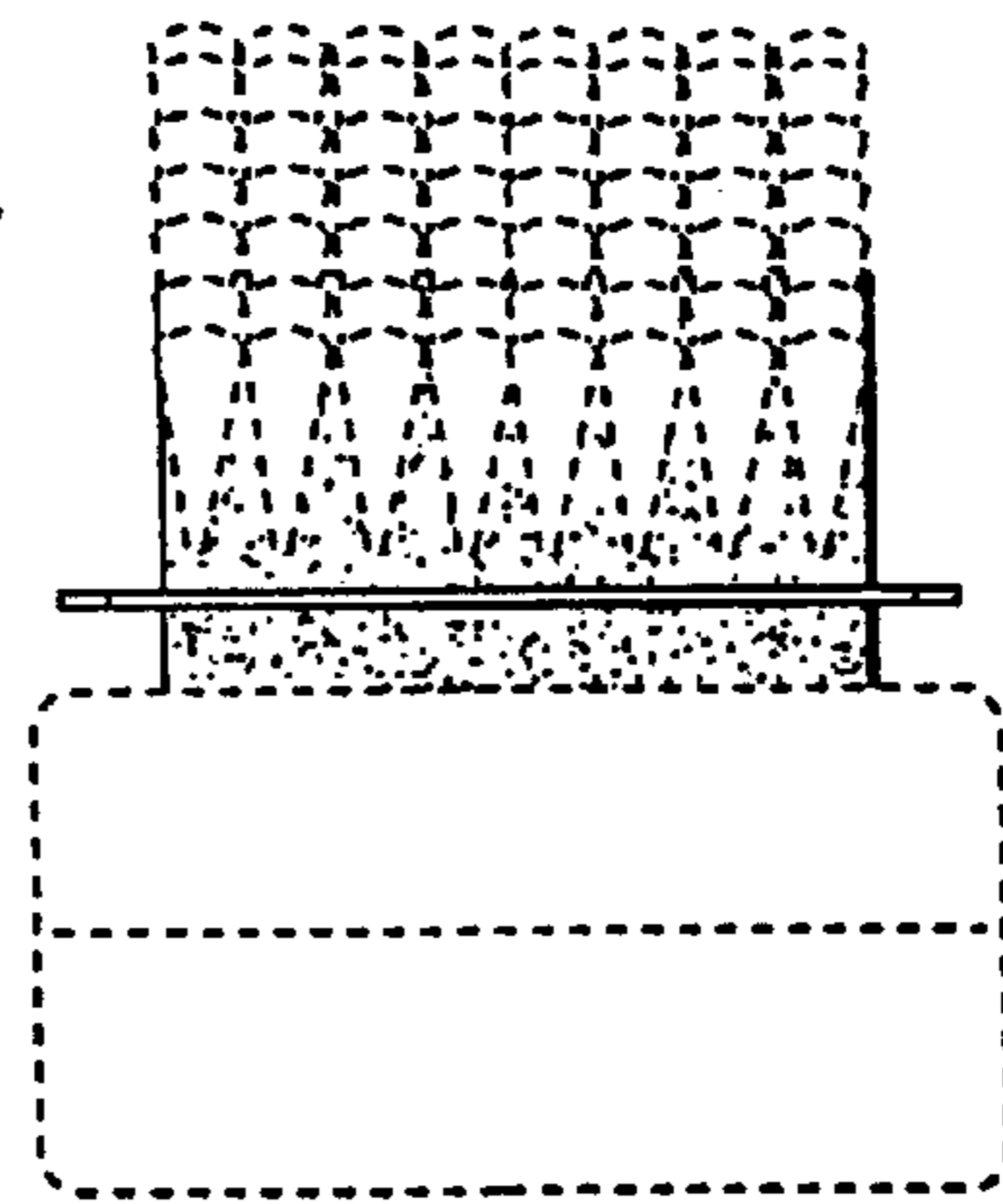
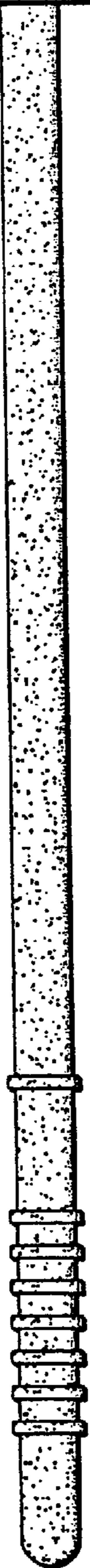

Fig. 5



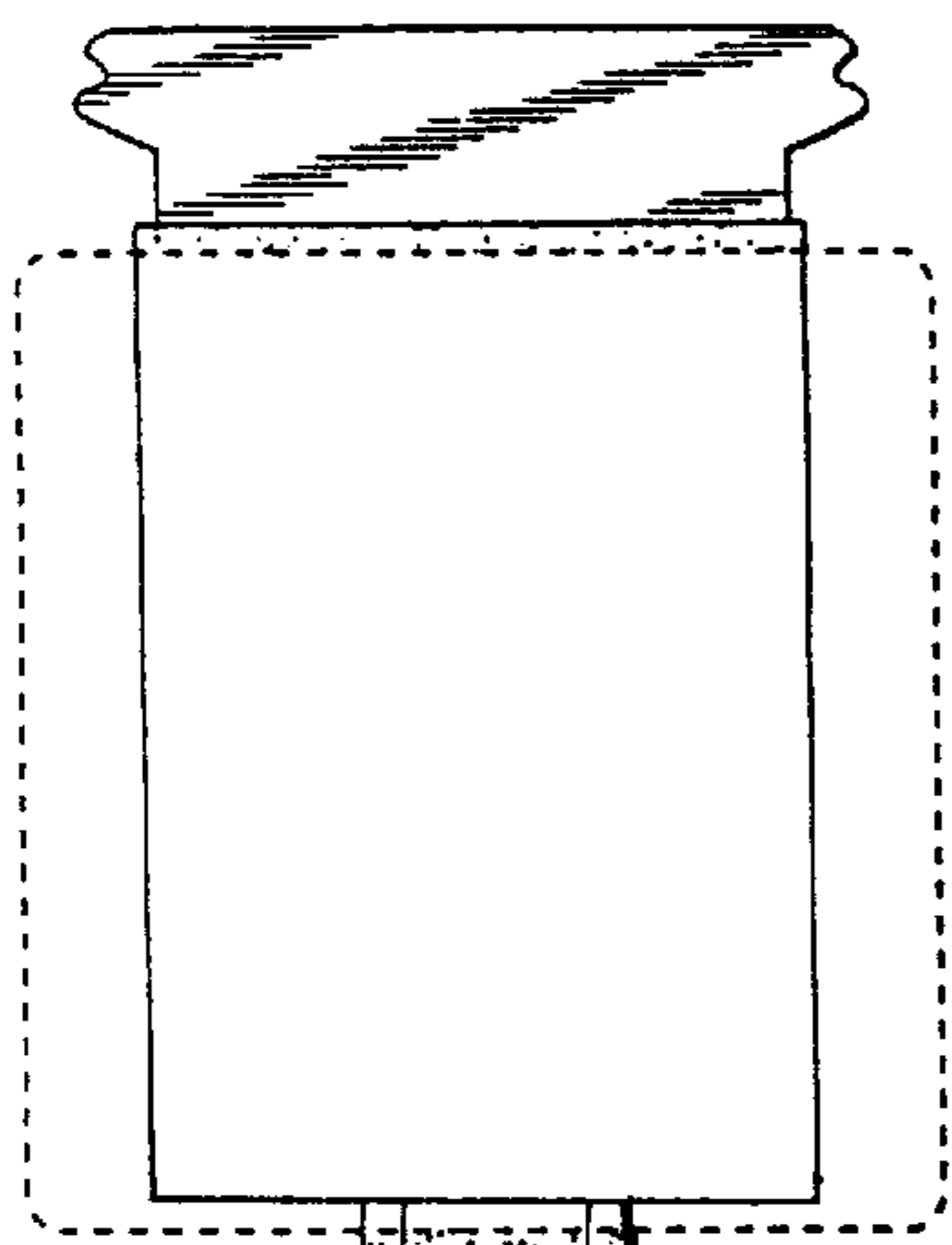

Fig. 2

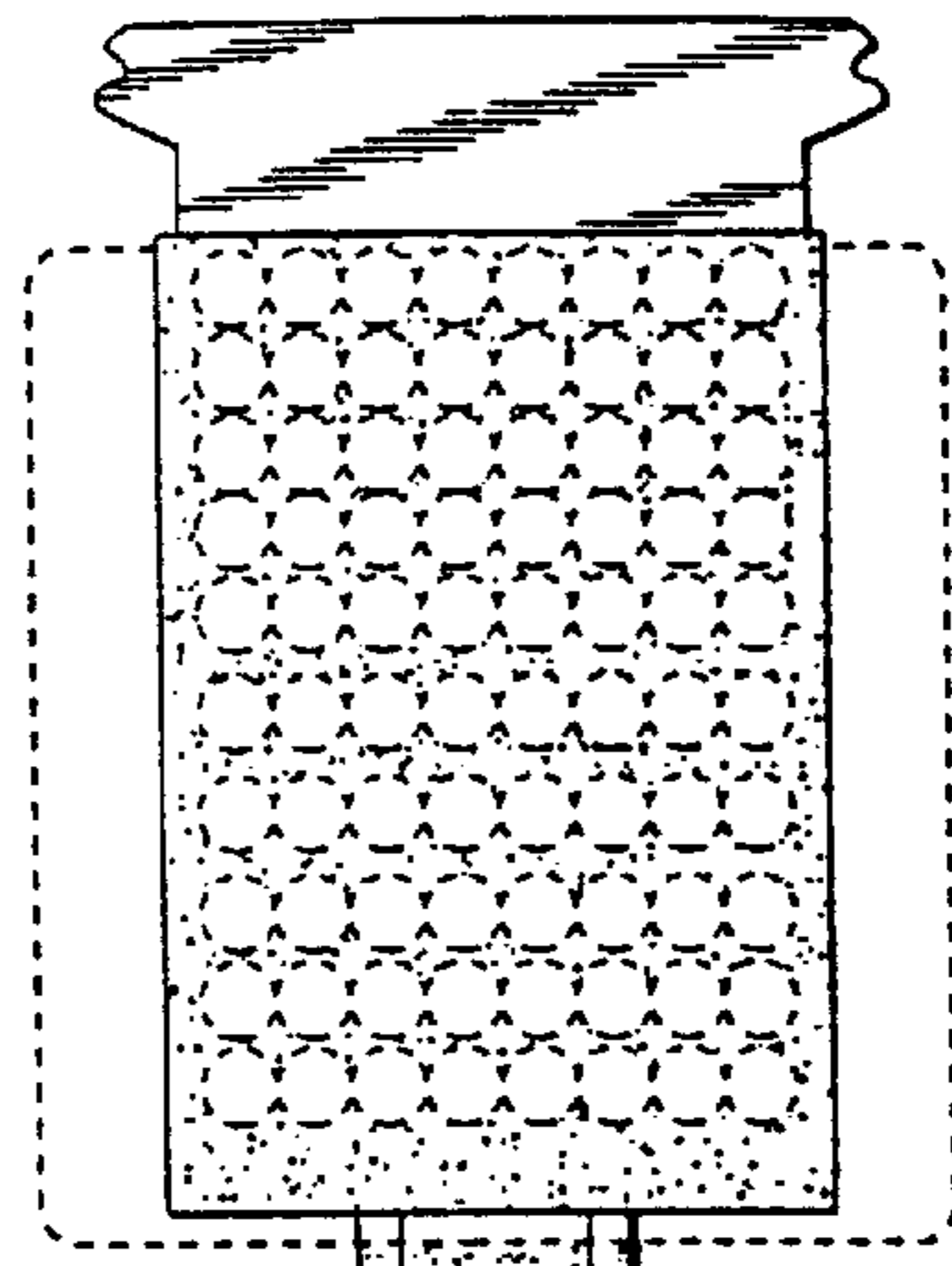

Fig. 3

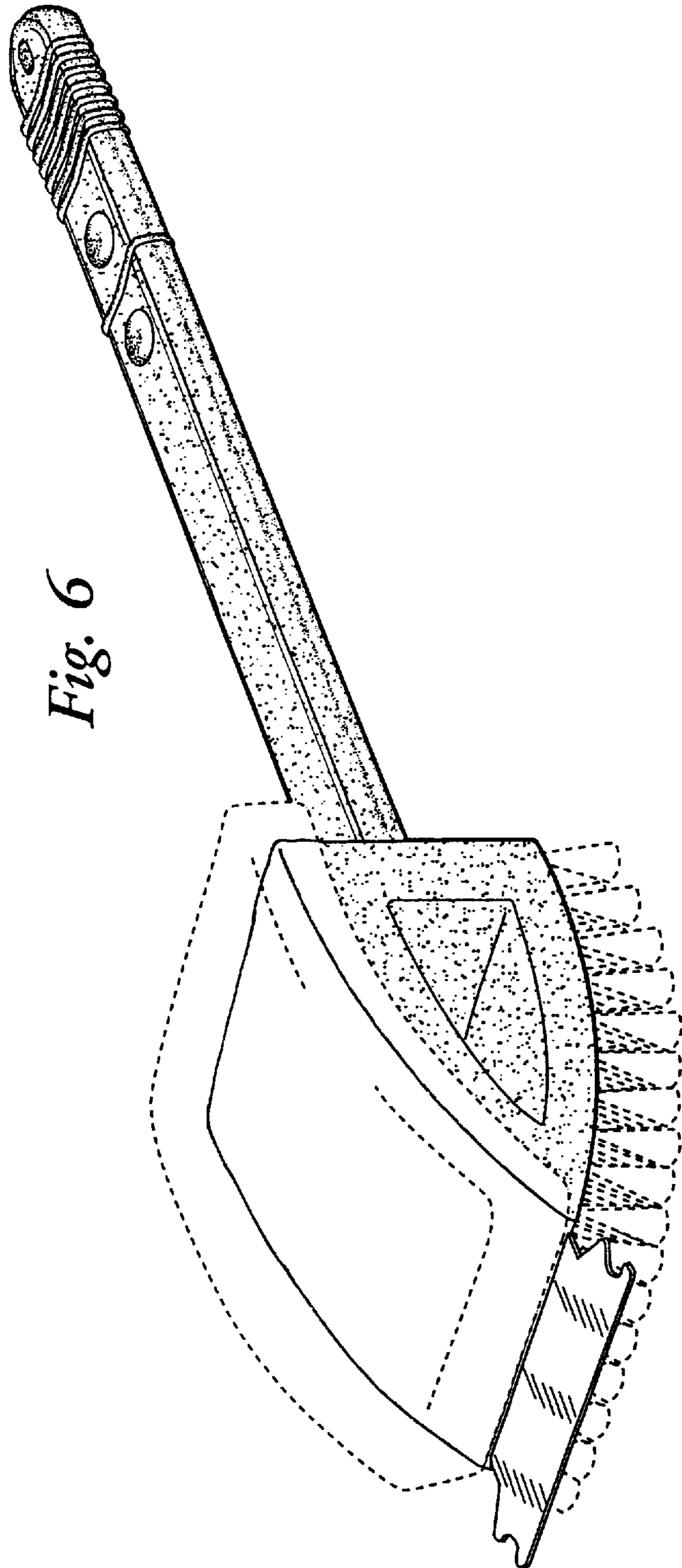

Fig. 6