



US00D400301S

# United States Patent [19] Wong

[11] Patent Number: **Des. 400,301**

[45] Date of Patent: **\*\*Oct. 27, 1998**

[54] **PEN SHAVER**

[76] Inventor: **Wai Tse Wong**, 23/F., Flat A,B&D, Etat  
Factory Bldg., 4 Heung Yip Road,  
Wong Chuk Hang, Hong Kong

[\*\*] Term: **14 Years**

[21] Appl. No.: **58,451**

[22] Filed: **Aug. 15, 1996**

[51] **LOC (6) Cl.** ..... **28-03**

[52] **U.S. Cl.** ..... **D28/45; D28/46; D19/43**

[58] **Field of Search** ..... **D28/44-48; D19/51;**  
**30/34.05, 29.5, 43, 43.4, 47-50, 84, 526,**  
**527, 528, 535**

[56] **References Cited**

**U.S. PATENT DOCUMENTS**

D. 156,961	1/1950	Hvid .....	D28/45
D. 225,788	1/1973	Rohrbach .....	D28/50
D. 226,338	2/1973	Tailer .....	D19/51
917,589	4/1909	Grabhorn .....	30/47
2,325,662	8/1943	Clarke .....	30/346.5 X
2,380,461	7/1945	Pedersen et al. ....	30/43.4
2,697,874	12/1954	Tomchek .....	30/50
4,332,321	6/1982	Wratschko .....	30/47 X
4,841,635	6/1989	Maurizi et al. ....	30/41
5,269,062	12/1993	Dallaire et al. ....	30/539 X

**FOREIGN PATENT DOCUMENTS**

278272	8/1988	European Pat. Off. ....	30/32
344331	3/1960	Switzerland .....	30/43.4
652261	4/1951	United Kingdom .....	30/43

*Primary Examiner*—Ted Shooman  
*Assistant Examiner*—C. Tuttle  
*Attorney, Agent, or Firm*—Ladas & Parry

[57] **CLAIM**

The ornamental design for a pen shaver, as shown and described.

**DESCRIPTION**

FIG. 1 is a front view of a pen shaver showing my new design with the top end facing to the left;  
FIG. 2 is a rear view thereof;  
FIG. 3 is a right side view, the left side view being a mirror image thereof;  
FIG. 4 is a top view thereof;  
FIG. 5 is a bottom view thereof;  
FIG. 6 is an exploded right side view of the pen shaver;  
FIG. 7 is a right side view of the pen shaver with the cap on the opposite end thereof;  
FIG. 8 is a top view of FIG. 7;  
FIG. 9 is a left side view of FIG. 7;  
FIG. 10 is a rear view of FIG. 7;  
FIG. 11 is a front view of FIG. 7;  
FIG. 12 is a front view of the pen shaver with the cap positioned on the end as in FIGS. 7-11 and showing the head portion rotated to the use position;  
FIG. 13 is a rear view thereof;  
FIG. 14 is a right side view thereof;  
FIG. 15 is a left side view thereof;  
FIG. 16 is a top view thereof; and,  
FIG. 17 is a bottom view thereof.

**1 Claim, 4 Drawing Sheets**

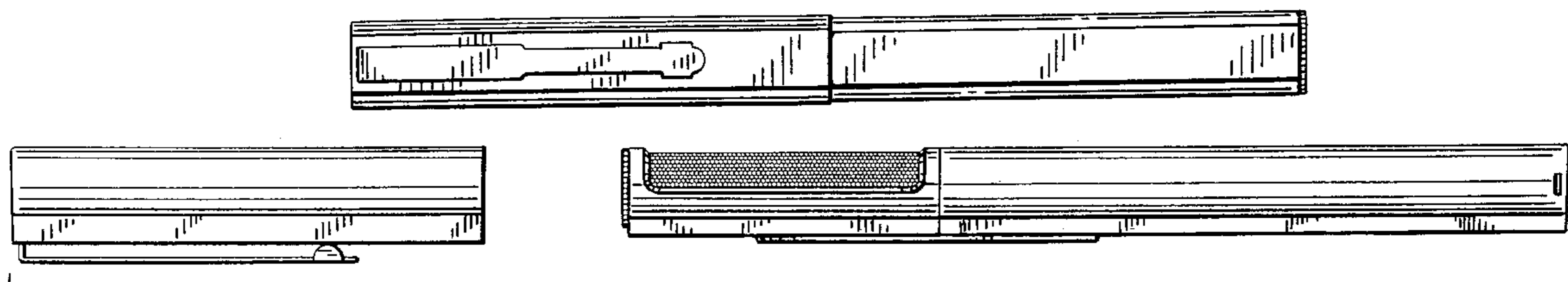

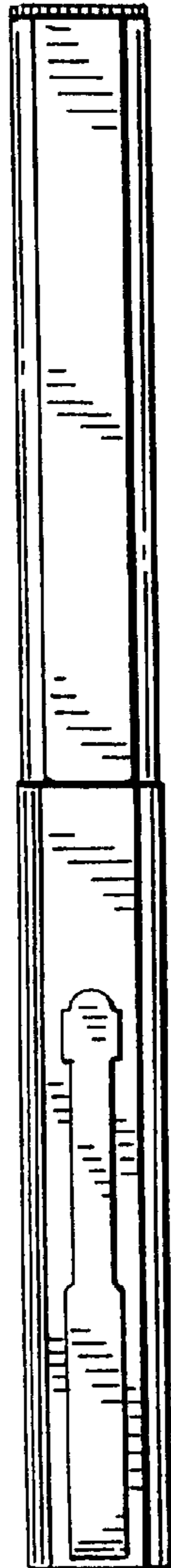

FIG. 1

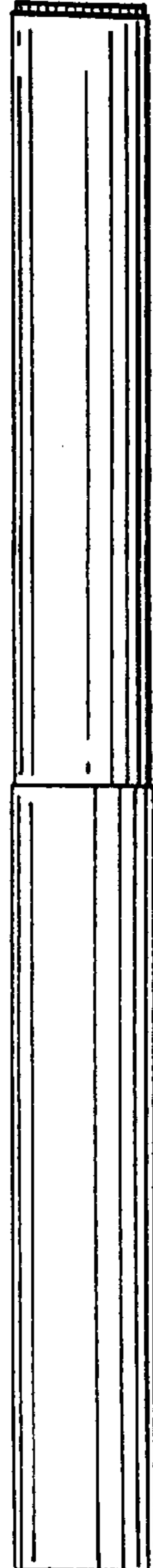

FIG. 2

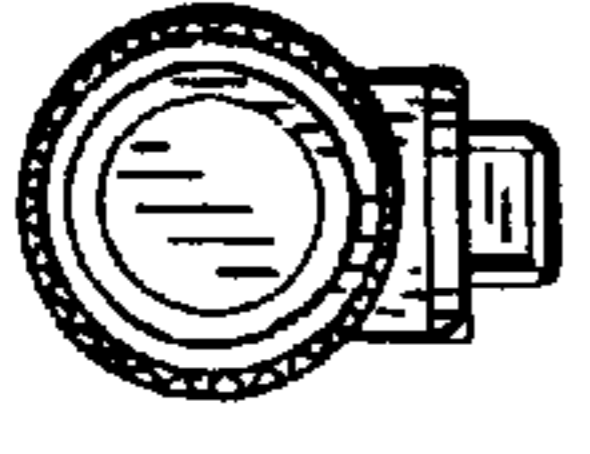

FIG. 5

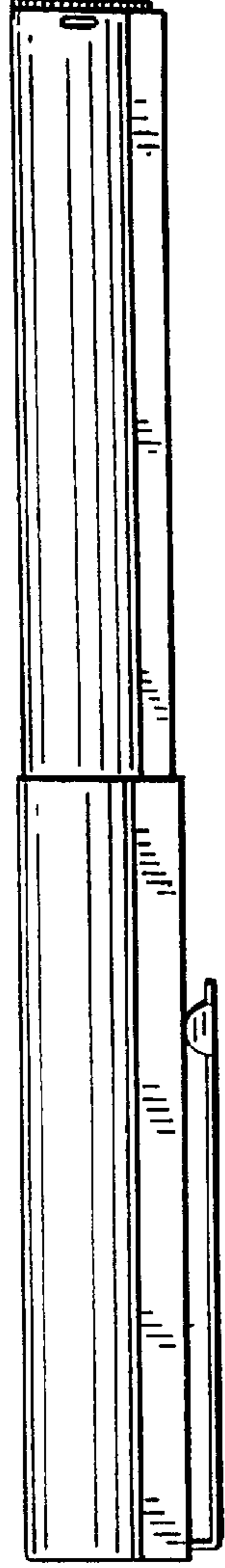

FIG. 3

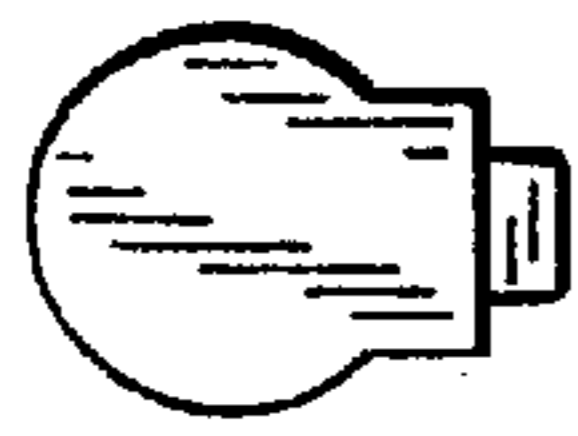

FIG. 4

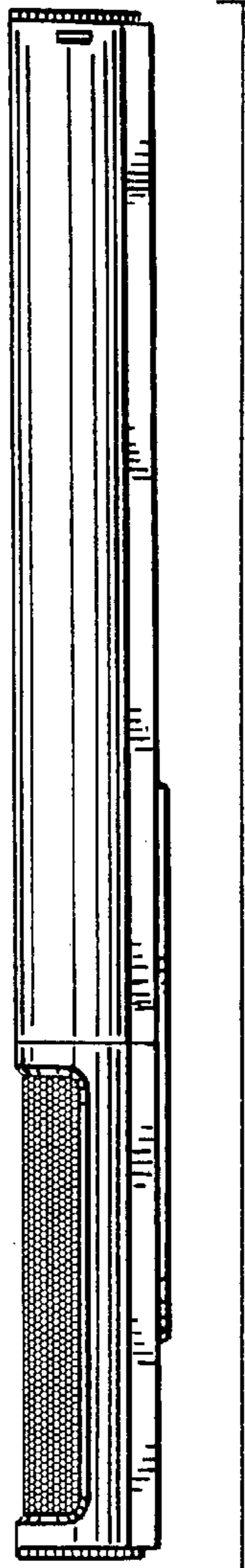

FIG. 6

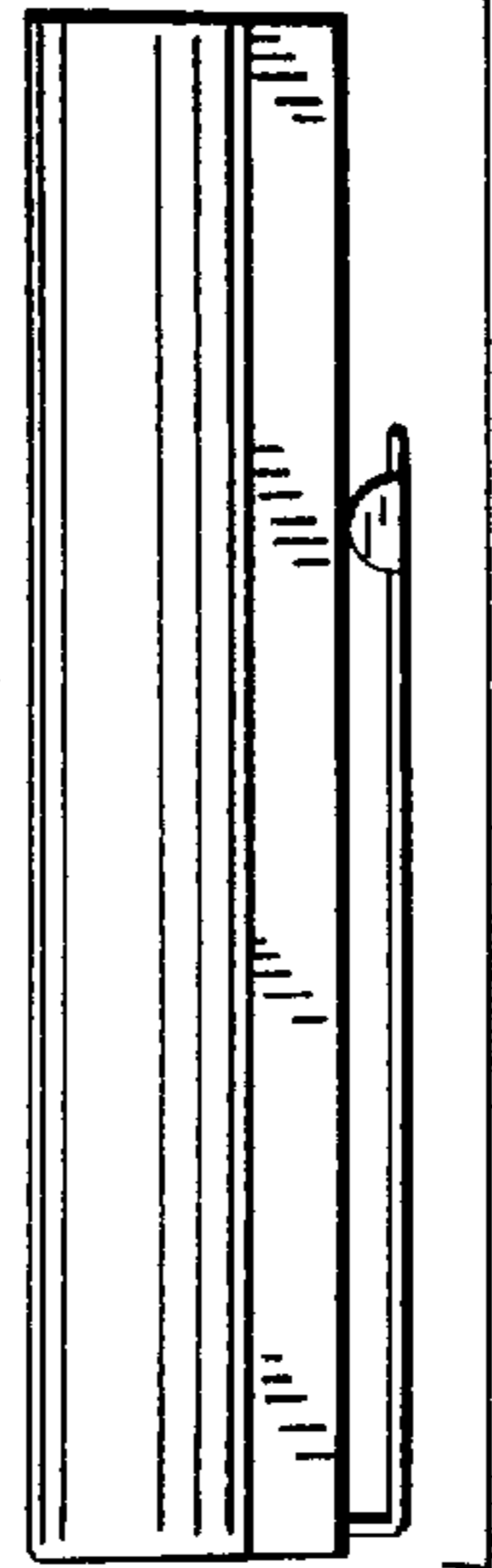

FIG. 7

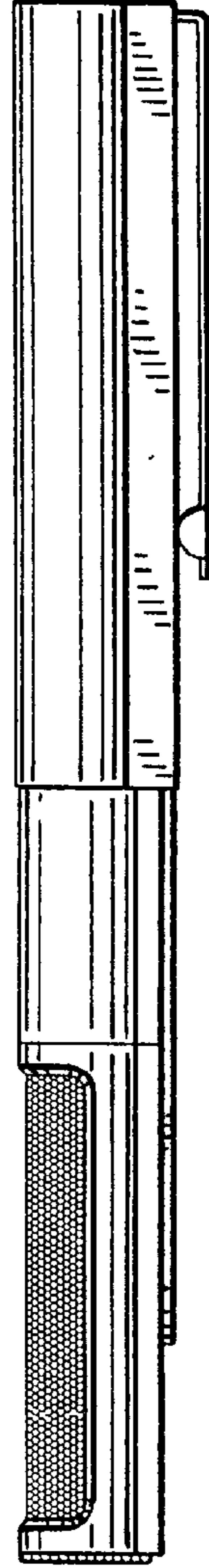

FIG. 8

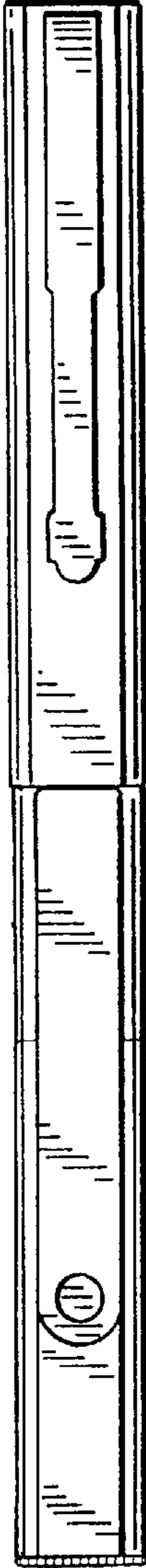

FIG. 10

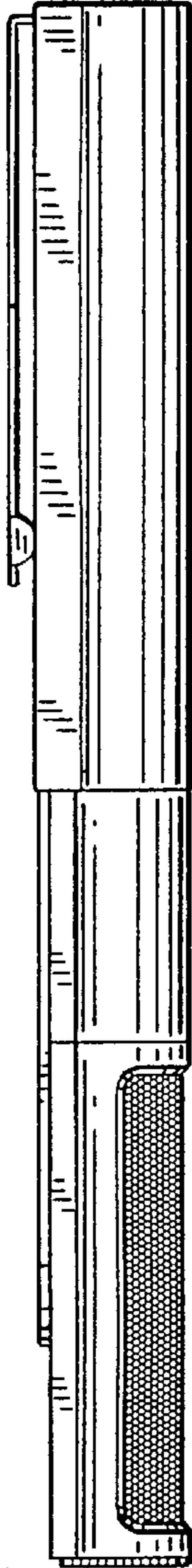

FIG. 9

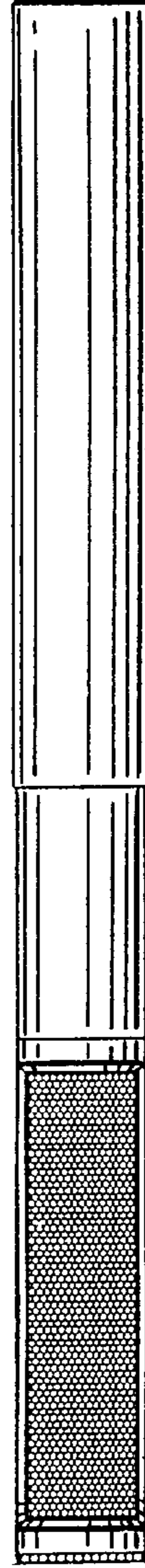

FIG. 11

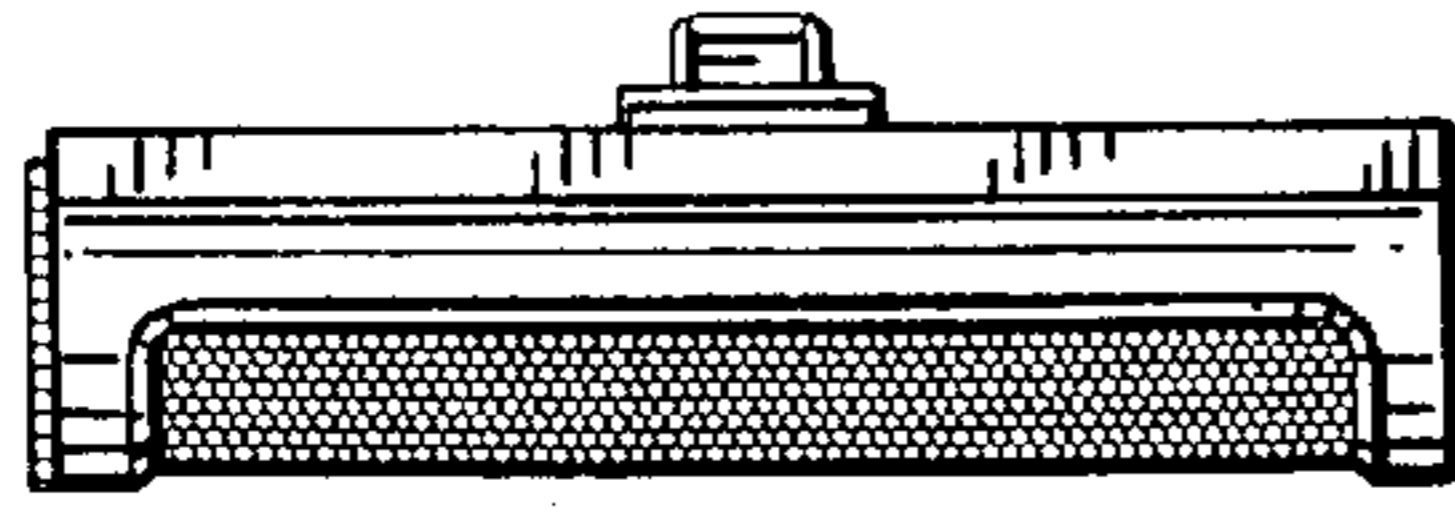

FIG. 16

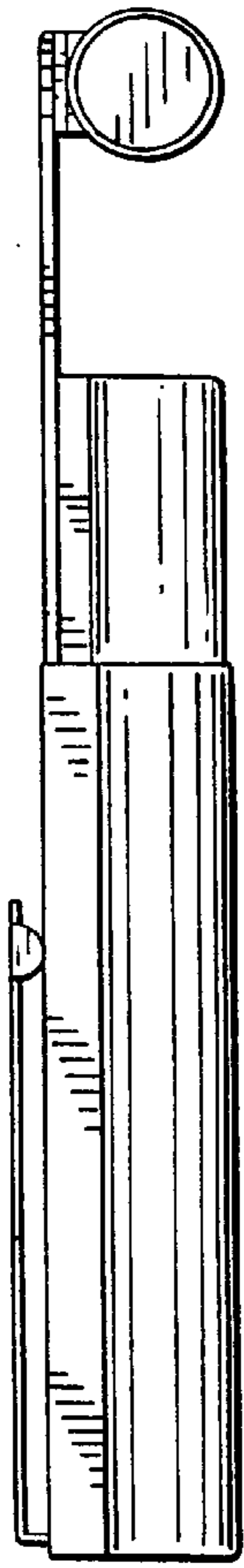

FIG. 14

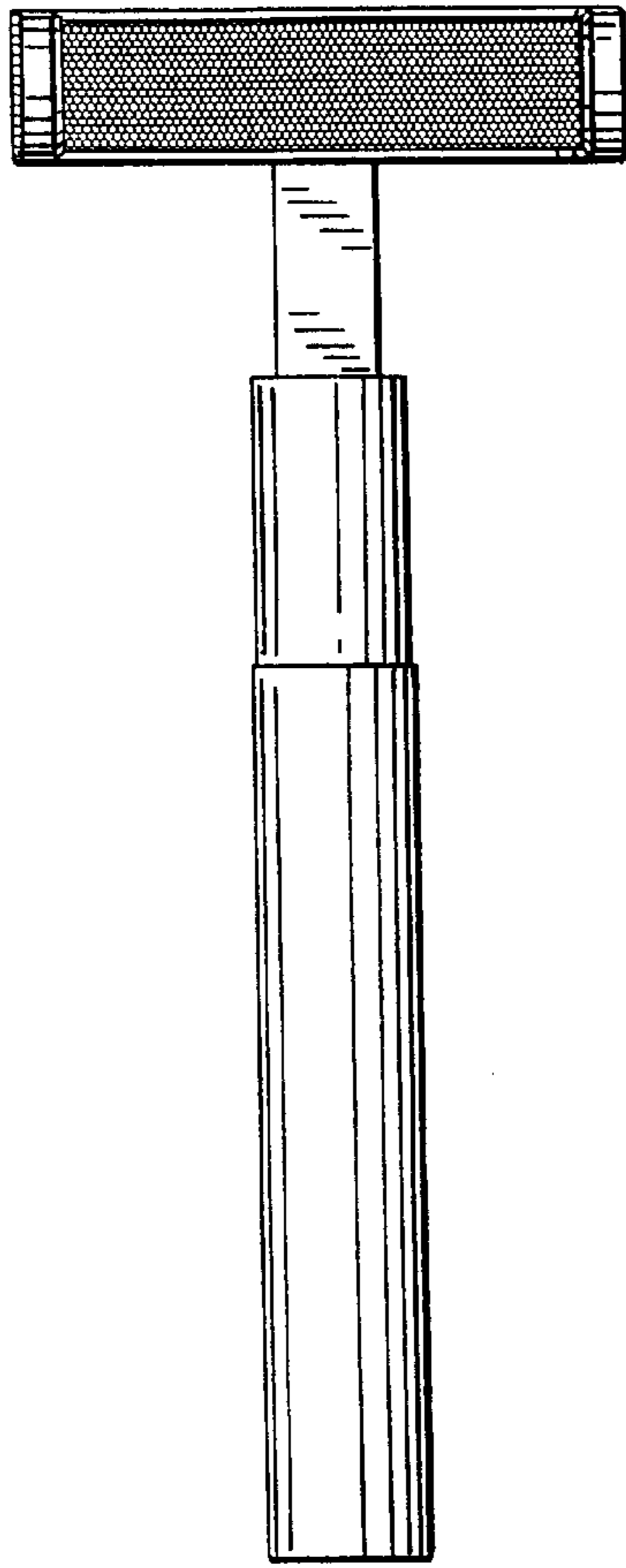

FIG. 12

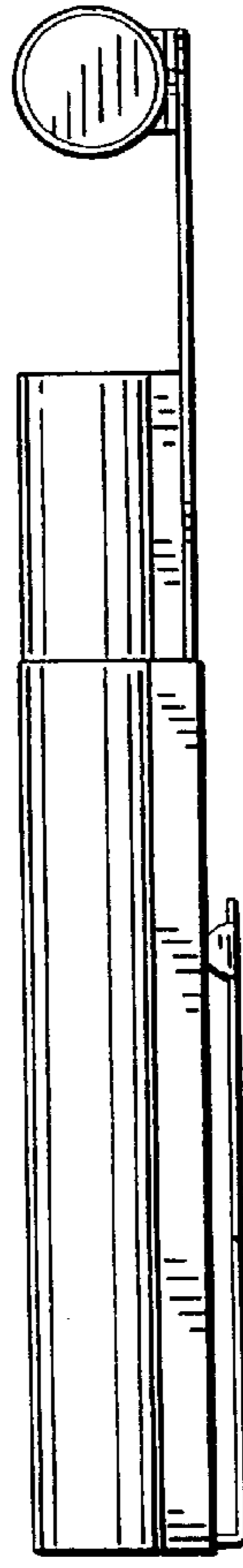

FIG. 15

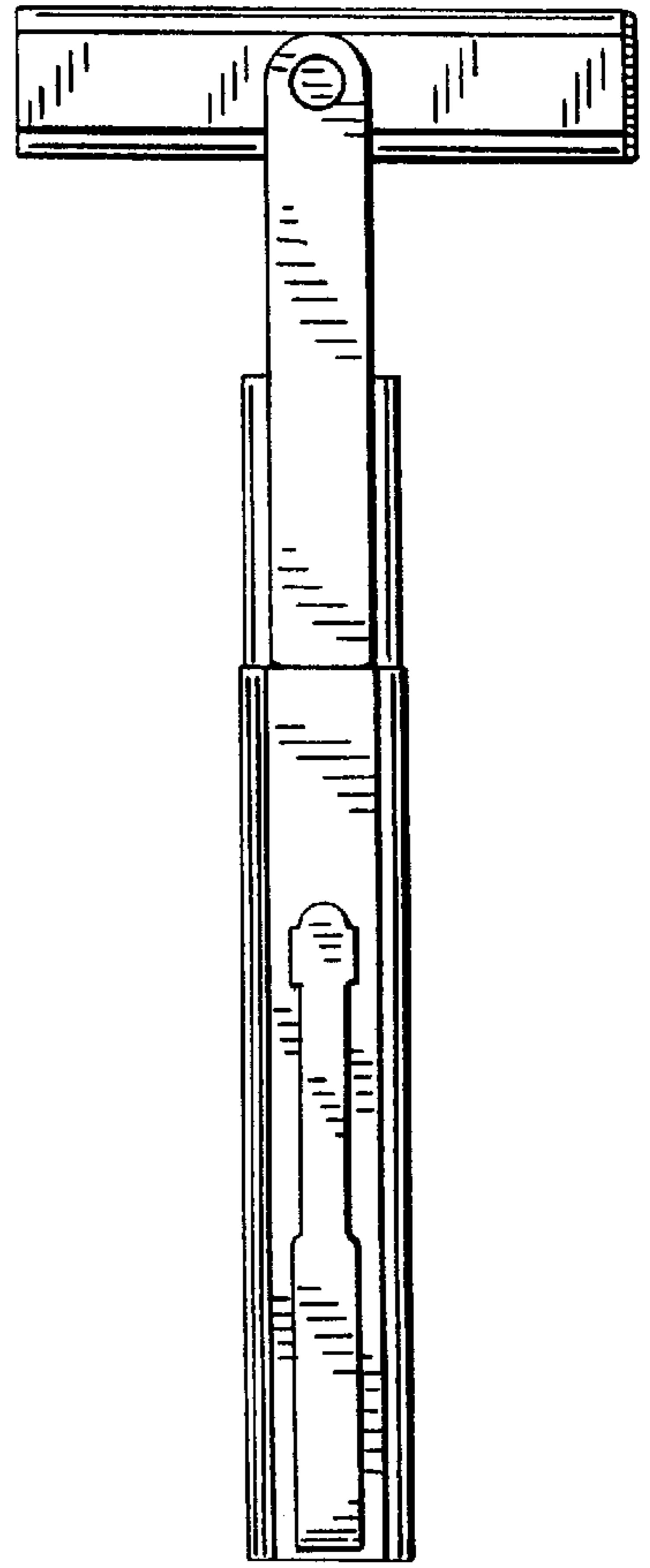

FIG. 13

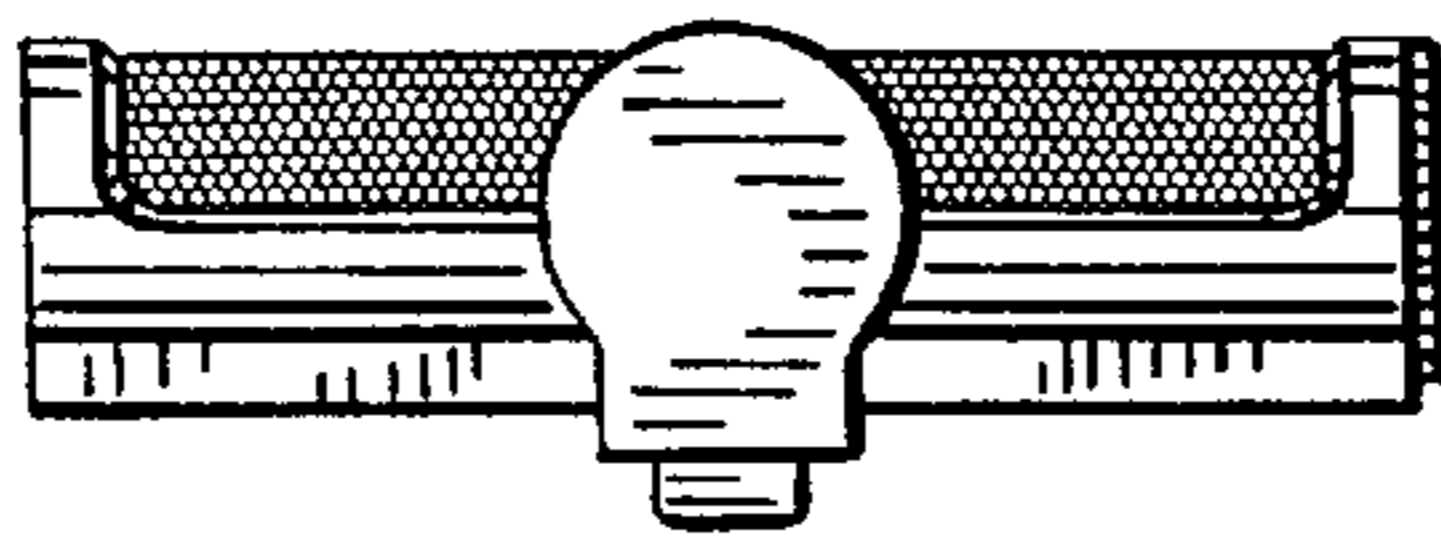

FIG. 17