



US00D400166S

United States Patent [19]

Concari et al.

[11] **Patent Number: Des. 400,166**

[45] **Date of Patent: **Oct. 27, 1998**

[54] **CHARGER HOUSING**

5,432,689 7/1995 Sharrah et al. 362/183
5,489,807 2/1996 Sanjuan et al. 320/114

[75] Inventors: **Gabriel E. Concari**, Eldersburg;
Gregory Scott Snider, Bel Air, both of Md.

OTHER PUBLICATIONS

Skill 92000 charging stand. Nov. 1991.
Skill 92010 charging stand. Nov. 1991.

[73] Assignee: **Black & Decker Inc.**, Newark, Del.

Primary Examiner—Joel Sincavage
Attorney, Agent, or Firm—Bruce S. Shapiro; Dennis A. Dearing; John D. Del Ponti

[**] Term: **14 Years**

[21] Appl. No.: **74,155**

[57] **CLAIM**

[22] Filed: **Jul. 29, 1997**

The ornamental design for a charger housing, as shown and described.

[51] **LOC (6) Cl.** **13-02**

[52] **U.S. Cl.** **D13/108**

[58] **Field of Search** D13/107, 108,
D13/118; 320/110–115

DESCRIPTION

[56] **References Cited**

FIG. 1 is a front perspective view of a charger housing showing our new design;
FIG. 2 is a front elevational view thereof;
FIG. 3 is a top plan view thereof;
FIG. 4 is a bottom plan view thereof;
FIG. 5 is a right side elevational view thereof; and,
FIG. 6 is a left side elevational view thereof.

U.S. PATENT DOCUMENTS

| | | | | |
|------------|---------|----------------|-------|-----------|
| D. 334,993 | 4/1993 | Lee | | D26/38 |
| D. 345,958 | 4/1994 | Keller et al. | | D13/108 |
| D. 351,675 | 10/1994 | Sharrah et al. | | D26/38 |
| 5,165,048 | 11/1992 | Keller et al. | | 320/113 |
| 5,172,043 | 12/1992 | Toops | | 320/113 X |

1 Claim, 4 Drawing Sheets

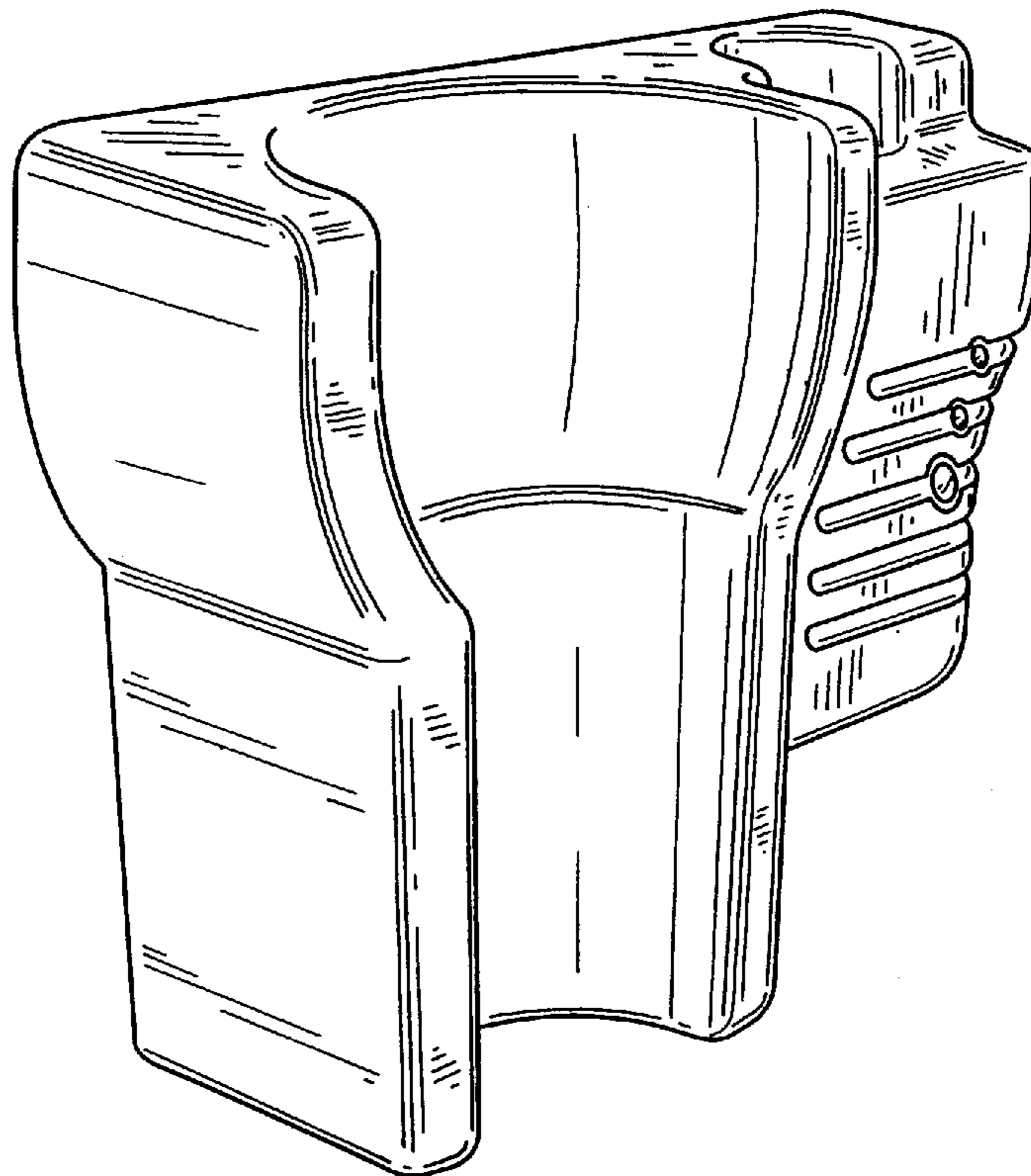

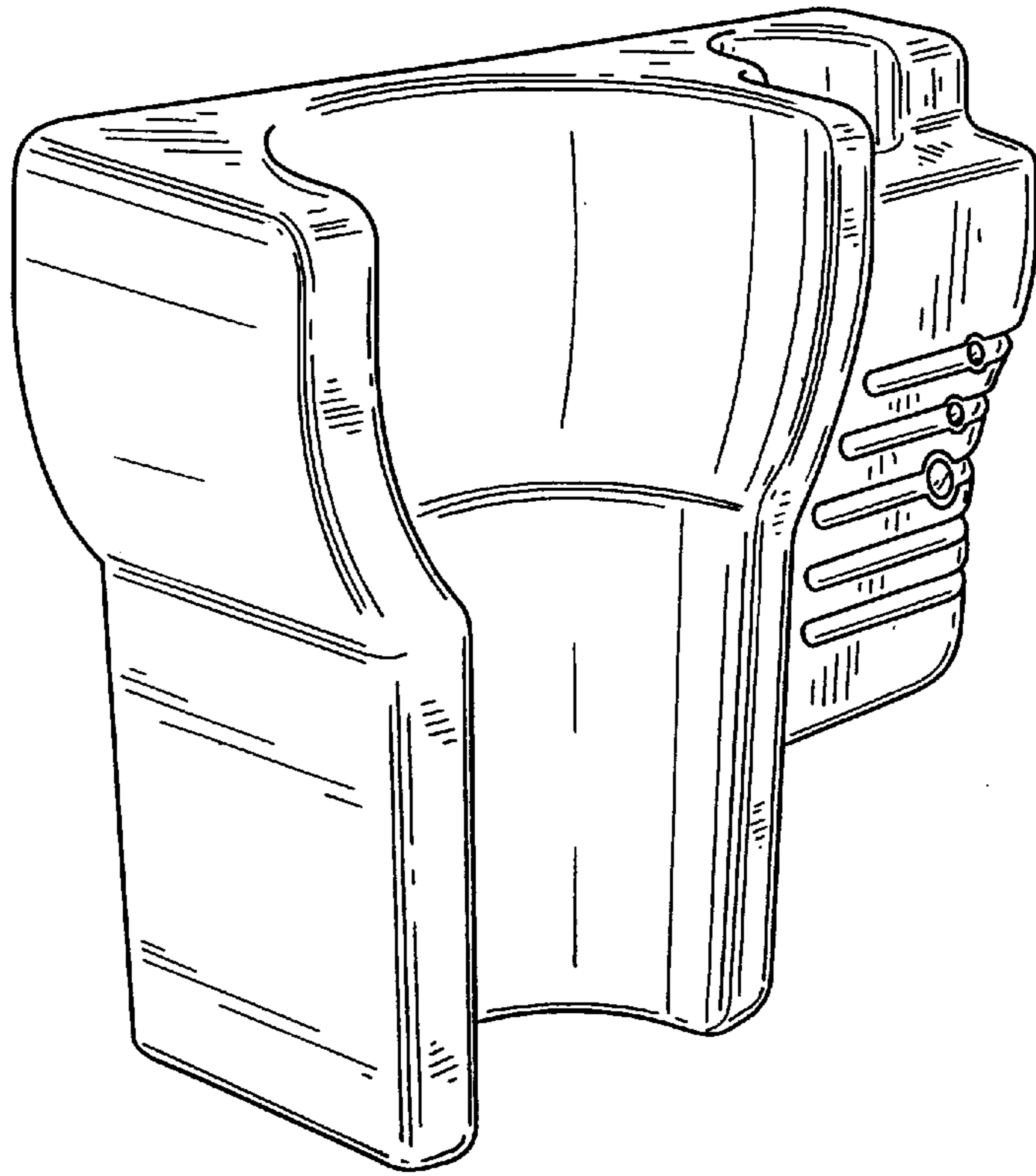

FIG. 1

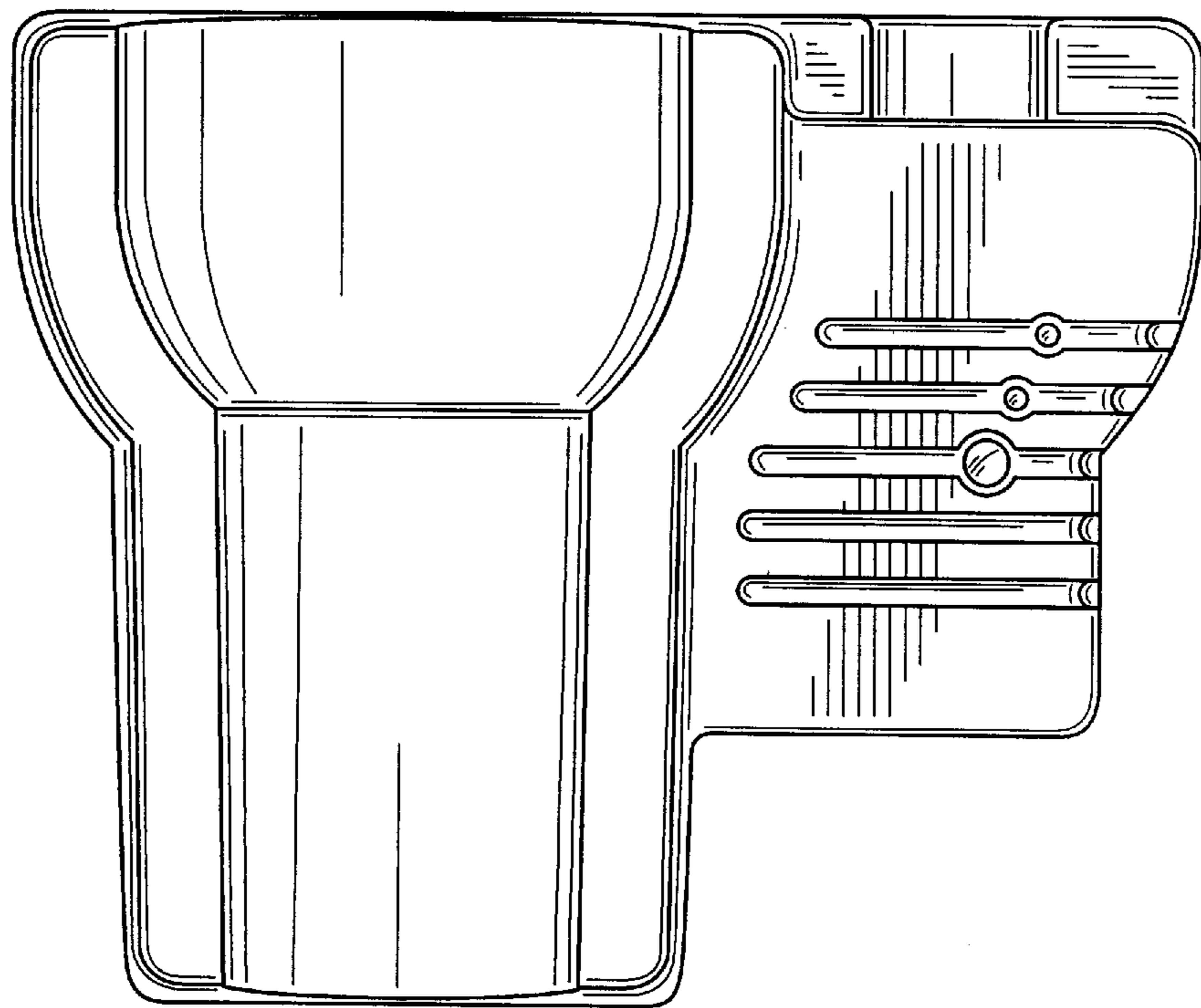

FIG. 2

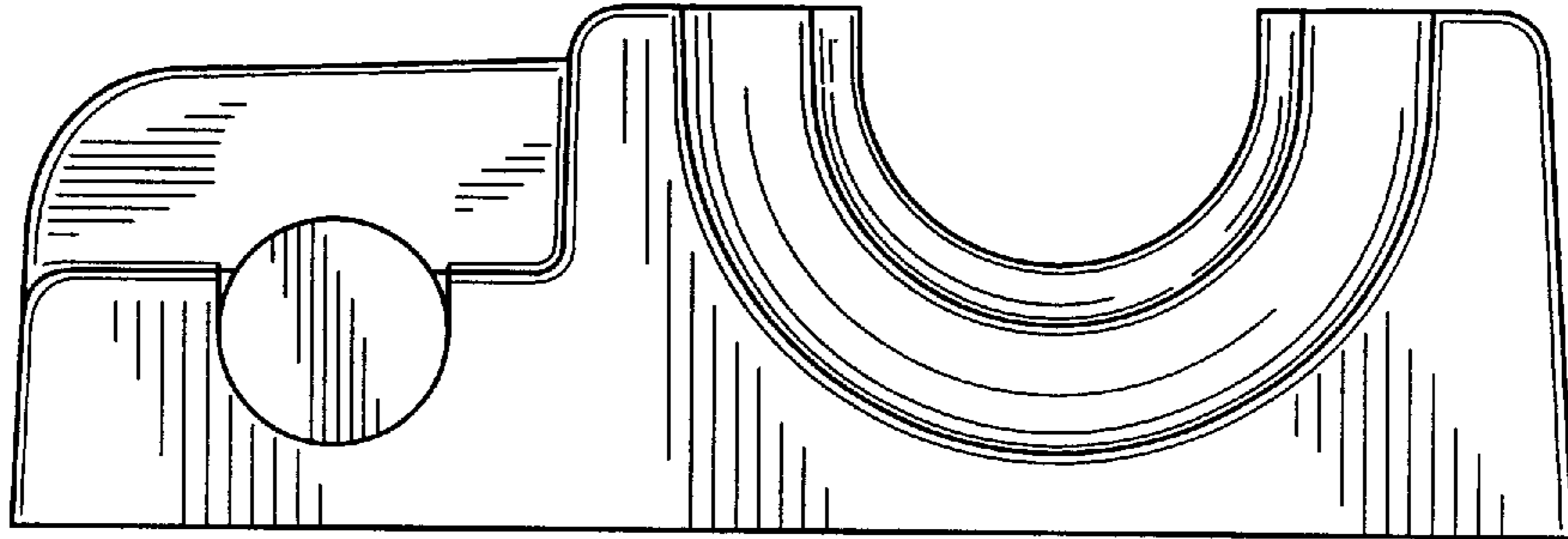

FIG. 3

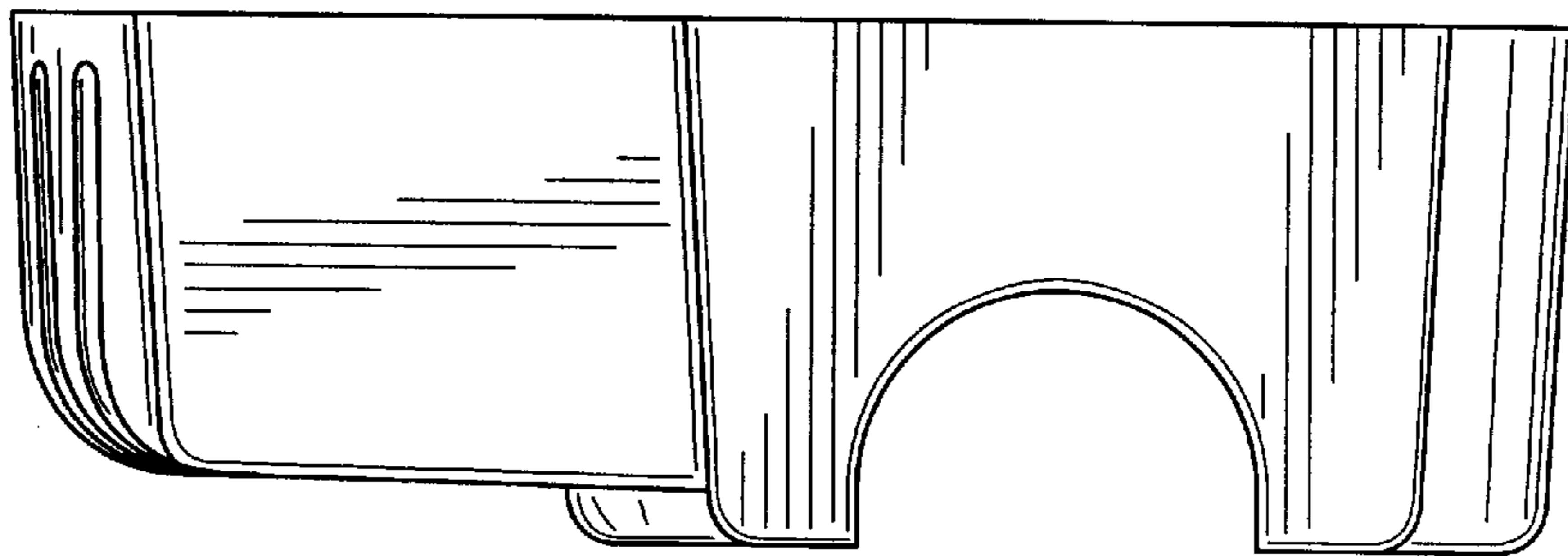

FIG. 4

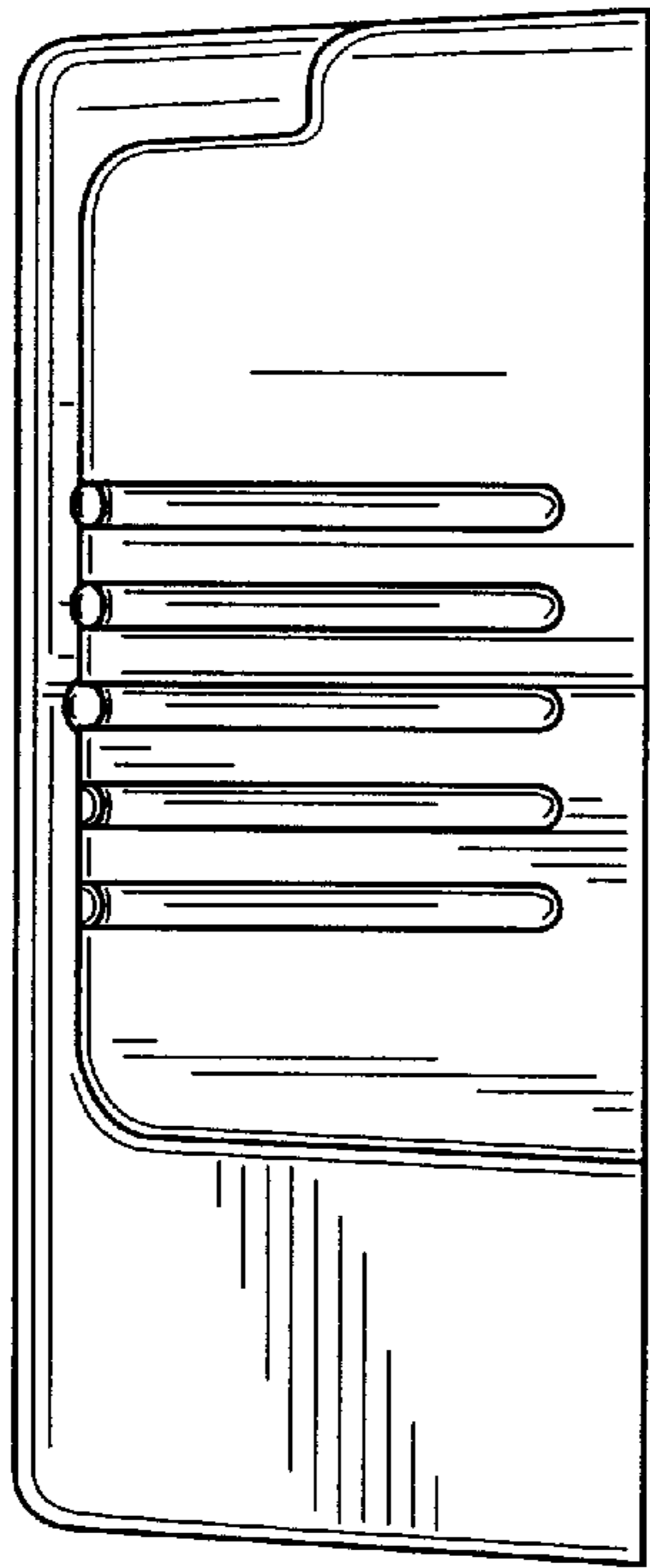

FIG. 5

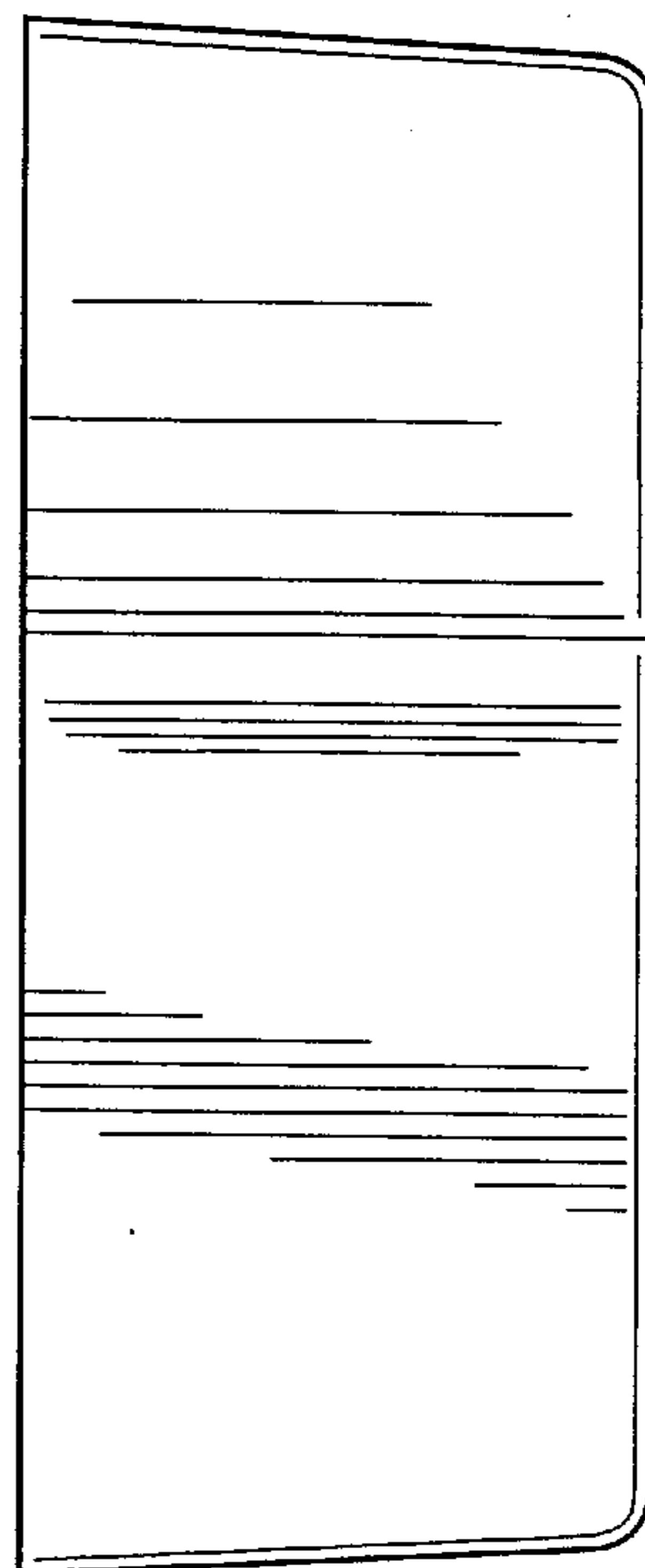

FIG. 6