



US00D400163S

# United States Patent [19] Lam

[11] **Patent Number: Des. 400,163**

[45] **Date of Patent: \*\*Oct. 27, 1998**

[54] **SOLAR POWERED BATTERY CHARGER**

[76] Inventor: **Yuen-Ming Lam**, 15/F., Tak King Industrial Building, 27 Lee Chung Street, Chaiwan, Hong Kong

[\*\*] Term: **14 Years**

[21] Appl. No.: **60,746**

[22] Filed: **Oct. 4, 1996**

[51] **LOC (6) Cl.** ..... **13-02**

[52] **U.S. Cl.** ..... **D13/107**

[58] **Field of Search** ..... D13/107, 108;  
320/3, 4, 5, 15

[56] **References Cited**

**U.S. PATENT DOCUMENTS**

D. 278,702	5/1985	Chiodo et al.	.....	D13/107
D. 278,703	5/1985	Chiodo et al.	.....	D13/107
D. 352,927	11/1994	Williams	.....	D13/107
D. 358,363	5/1995	Usami	.....	D13/107
D. 375,934	11/1996	Rosen et al.	.....	D13/107

**OTHER PUBLICATIONS**

Battery chargers on p. 365 of Hong Kong Enterprise, Jun. 1994.

*Primary Examiner*—Joel Sincavage

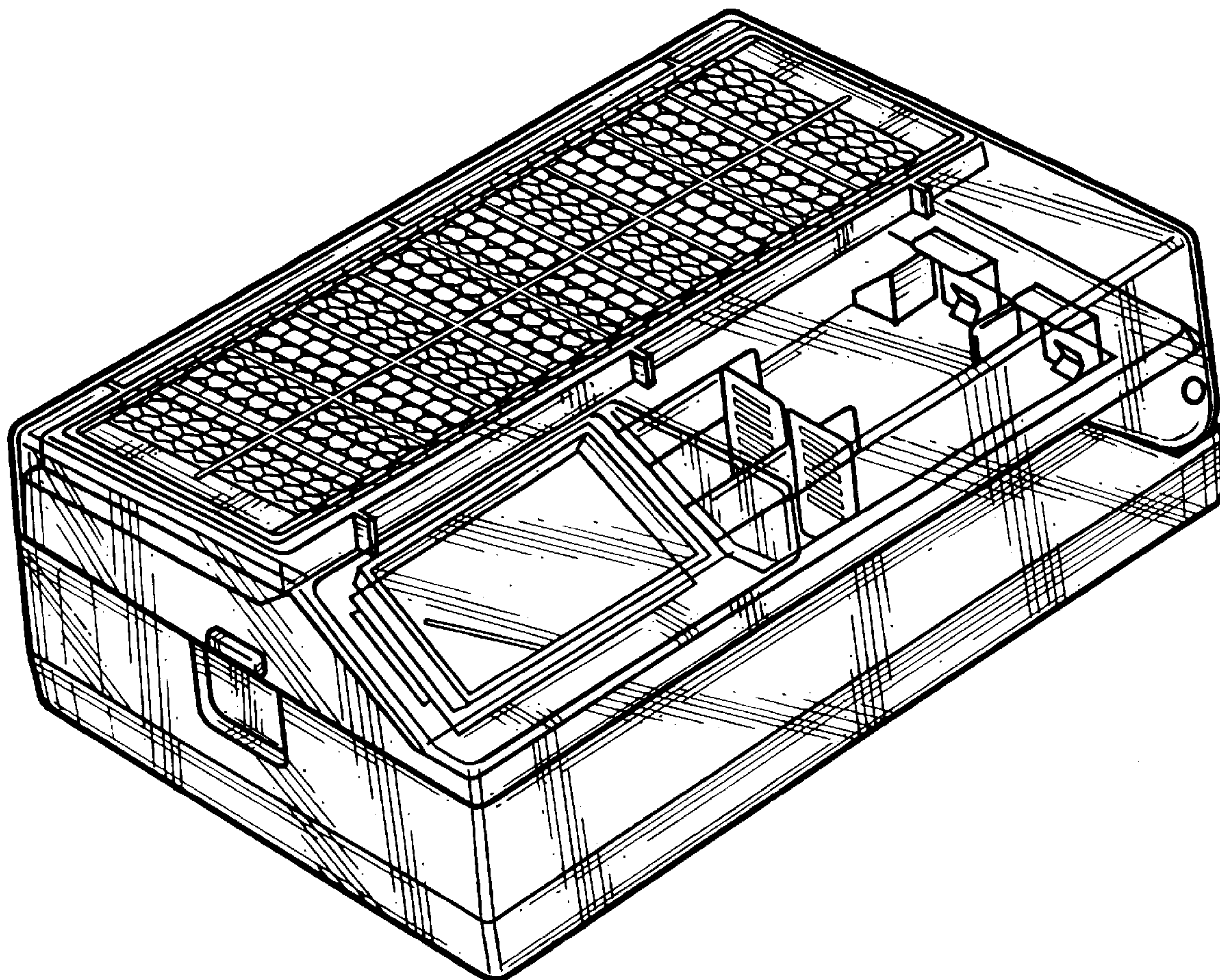
[57] **CLAIM**

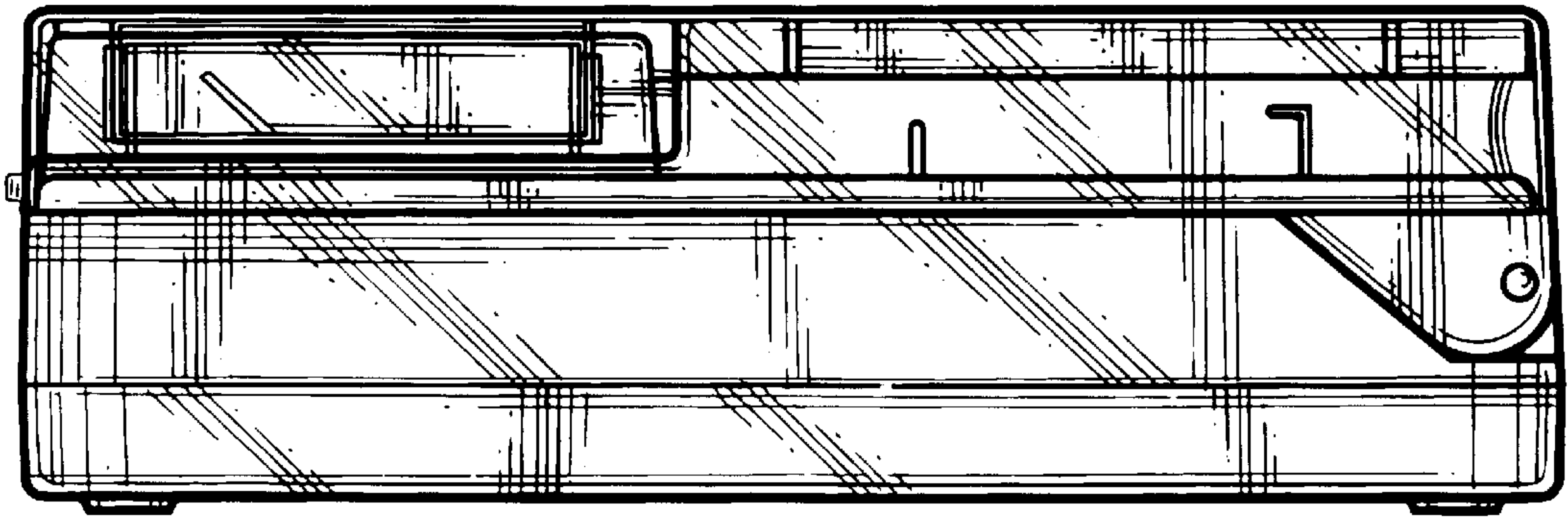
The ornamental design for a “solar powered battery charger”, as shown and described.

**DESCRIPTION**

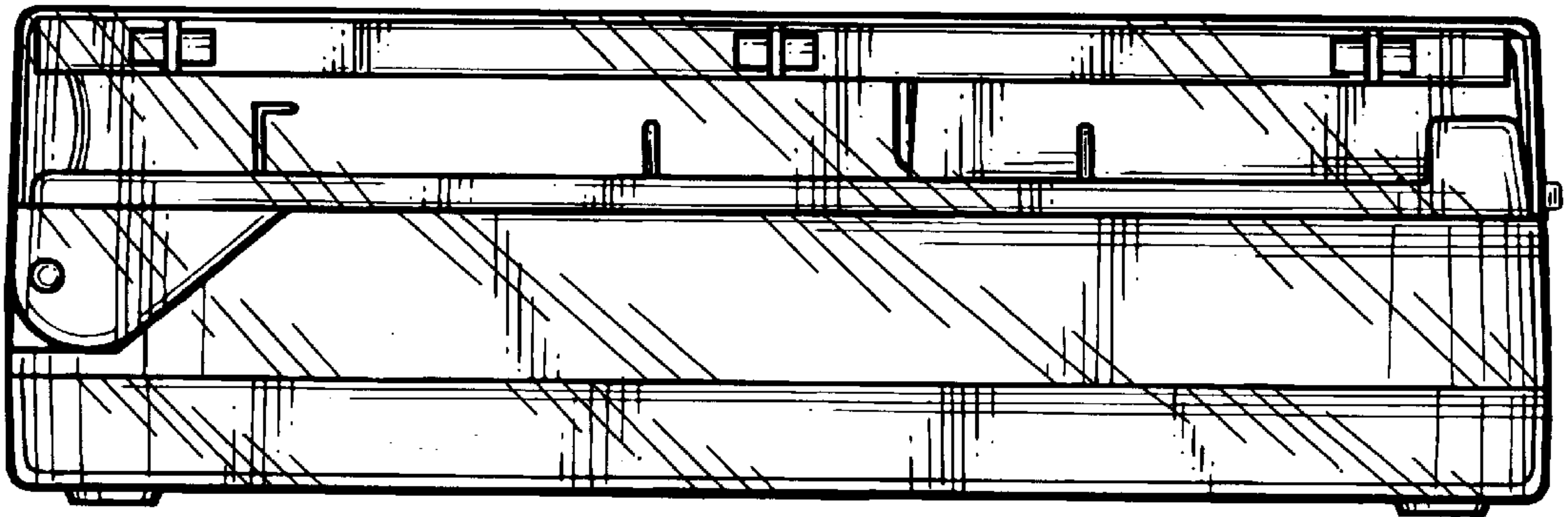
FIG. 1 is a front view of a “solar powered battery charger” showing my design;  
FIG. 2 is a rear view thereof;  
FIG. 3 is a top plan view thereof;  
FIG. 4 is a bottom plan view thereof;  
FIG. 5 is a left side elevational view thereof;  
FIG. 6 is a right side elevational view thereof;  
FIG. 7 is a perspective view thereof; and,  
FIG. 8 is a perspective view thereof with the cover in the open position.

**1 Claim, 8 Drawing Sheets**



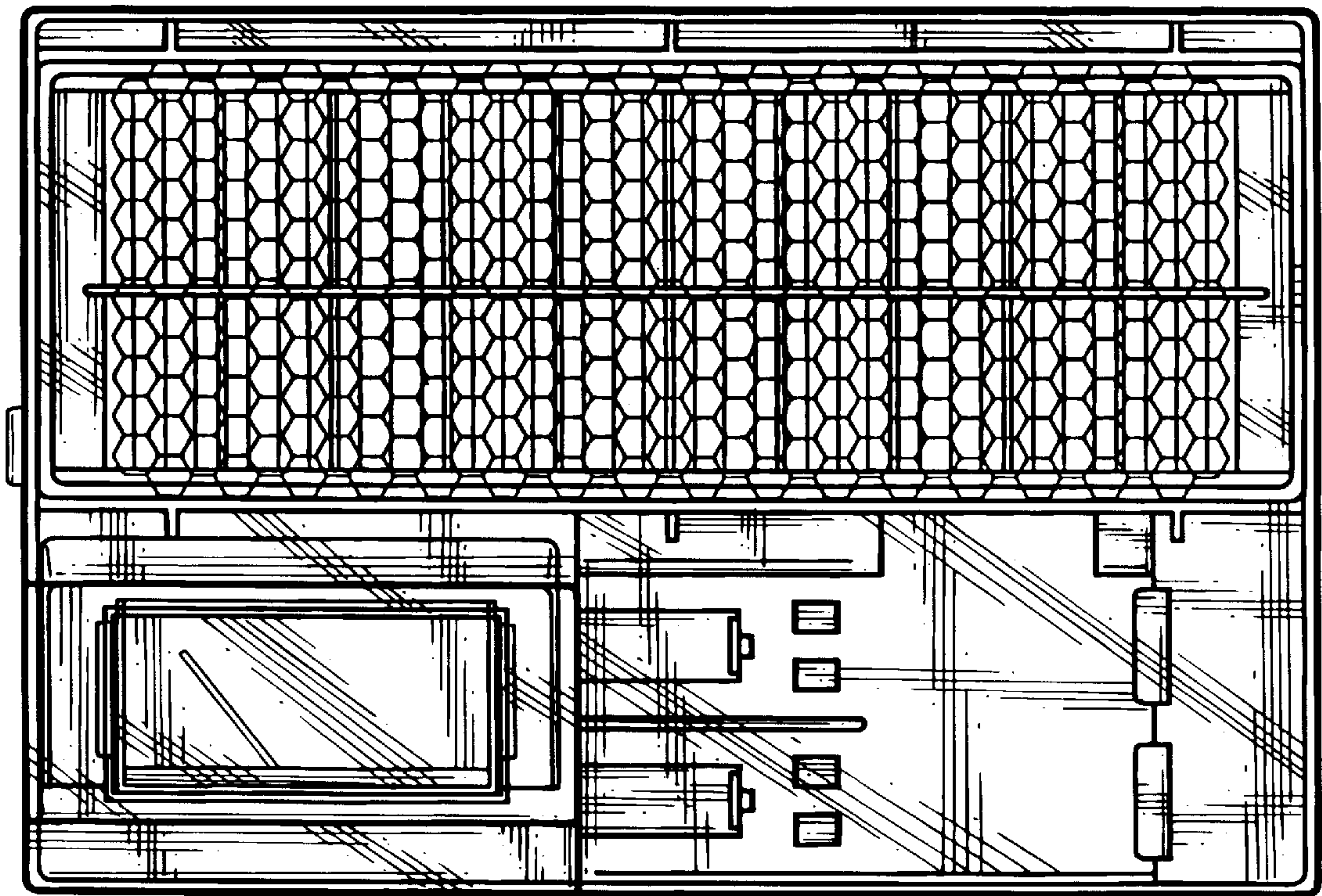


**FIG. 1**

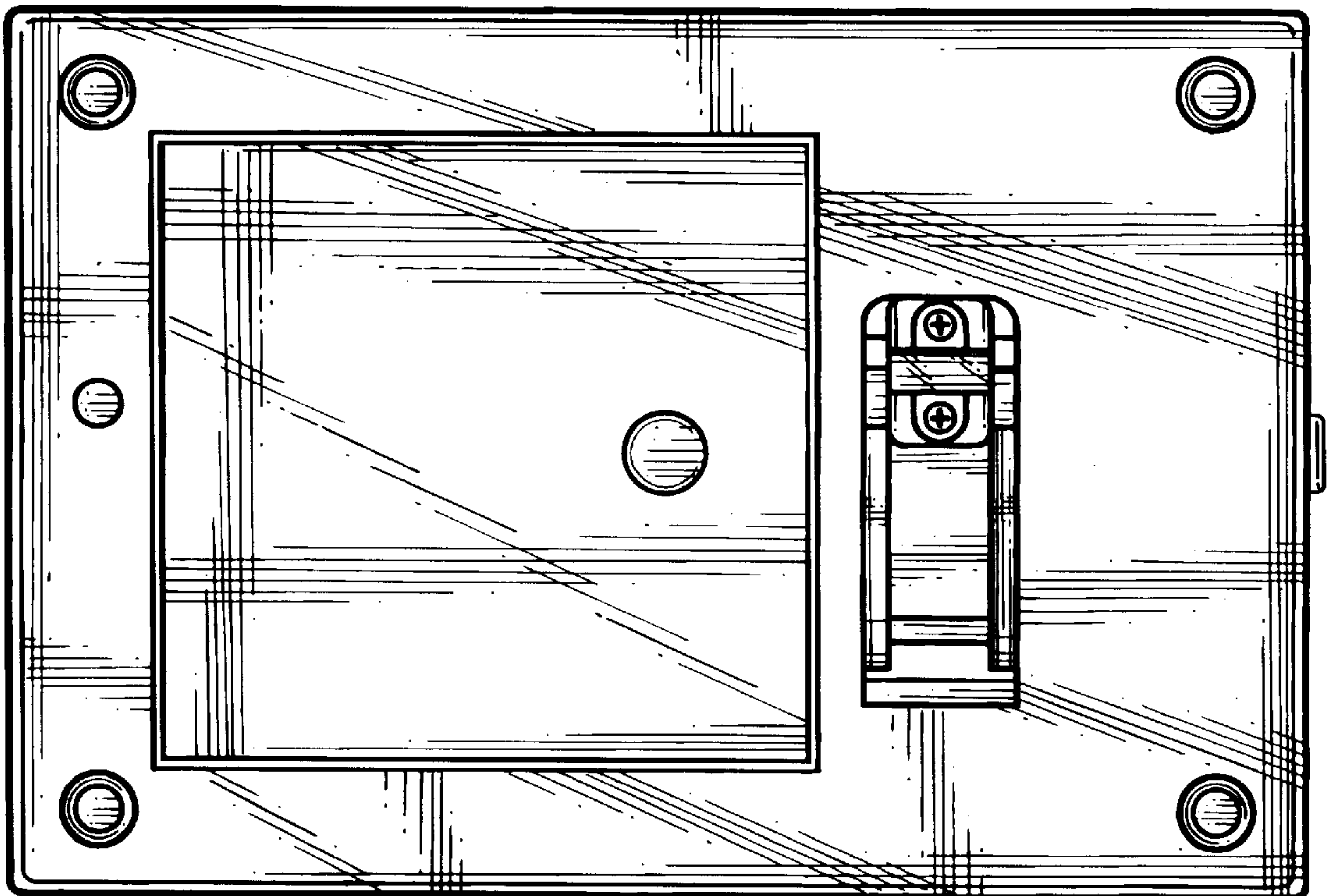


**FIG. 2**

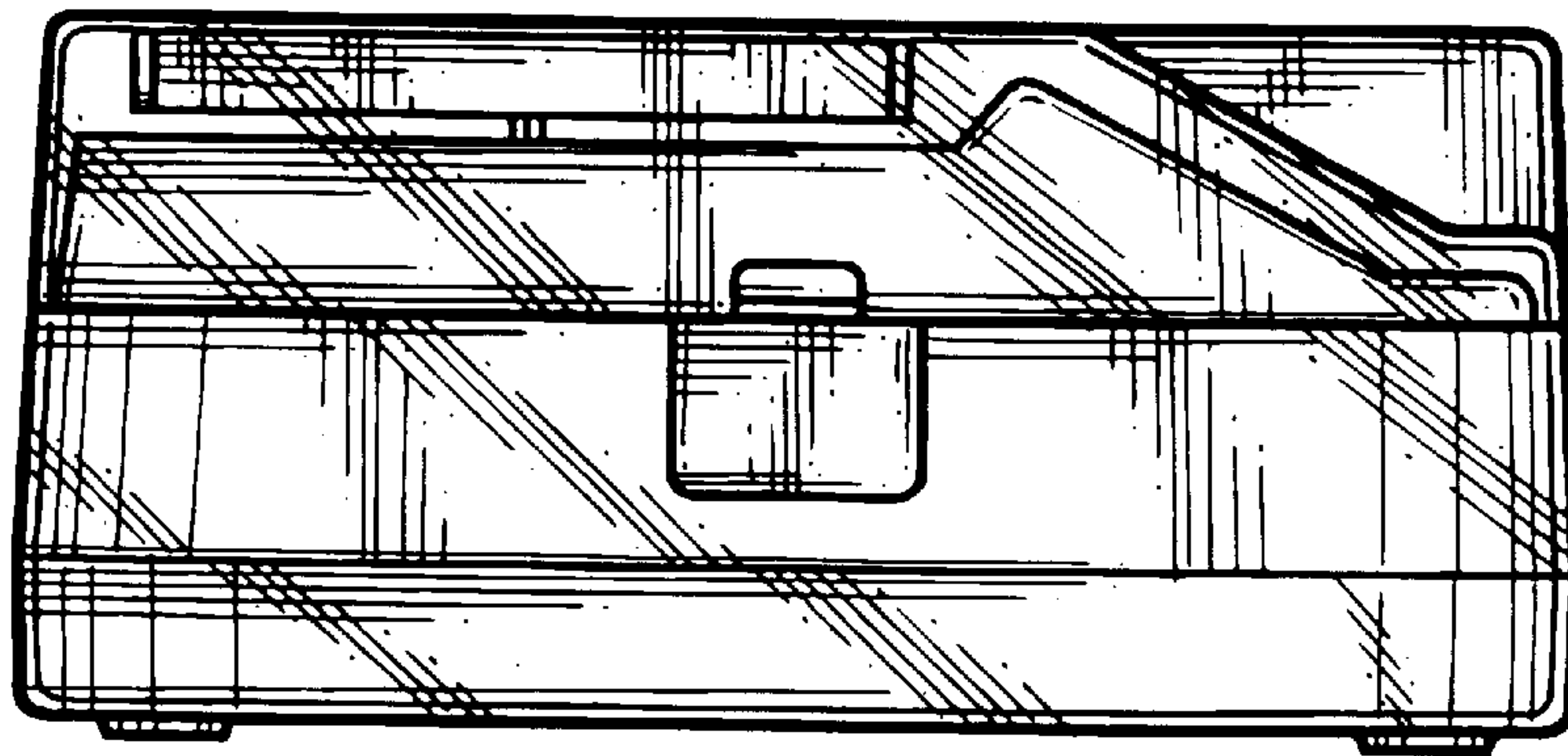




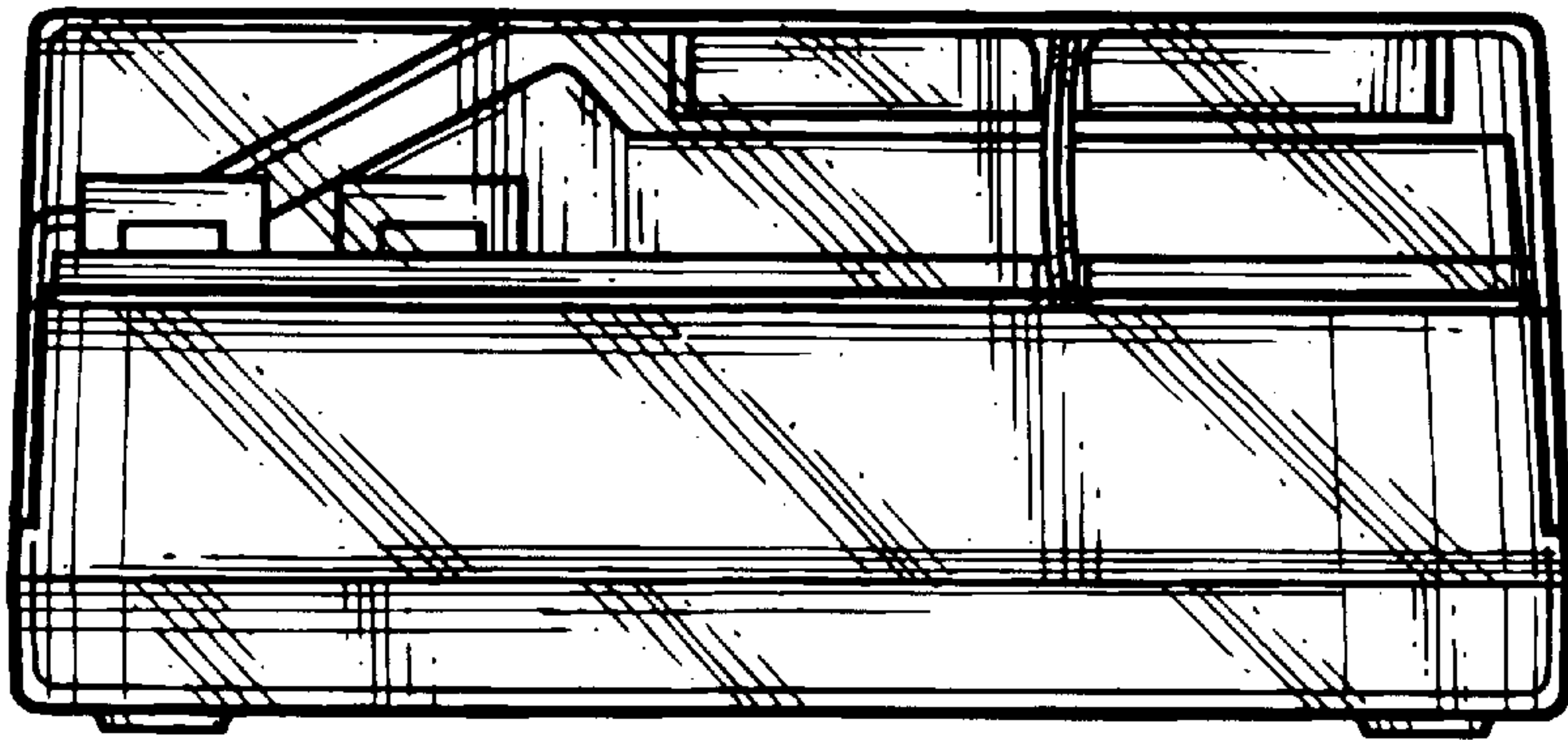
**FIG. 3**



**FIG. 4**

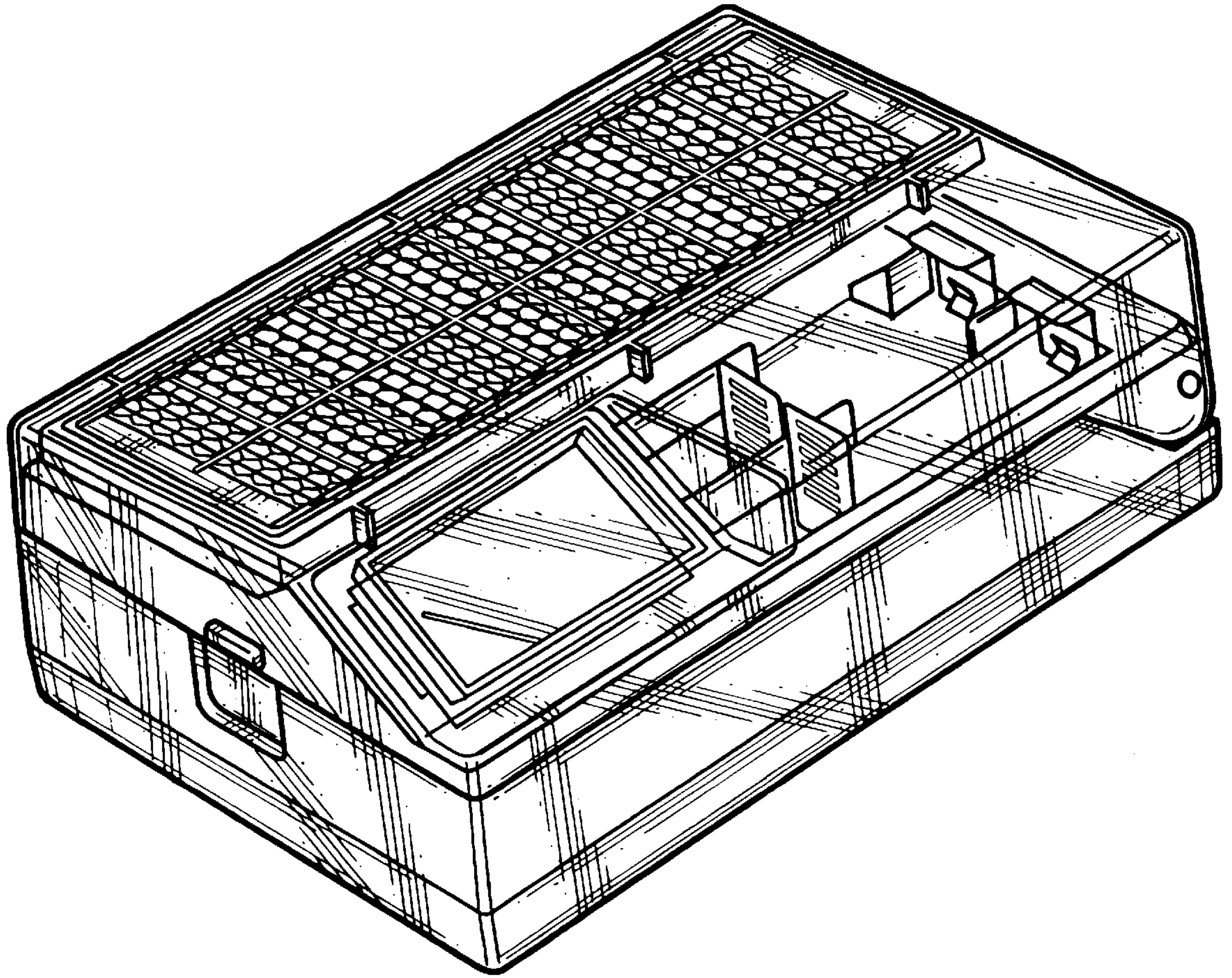


**FIG. 5**



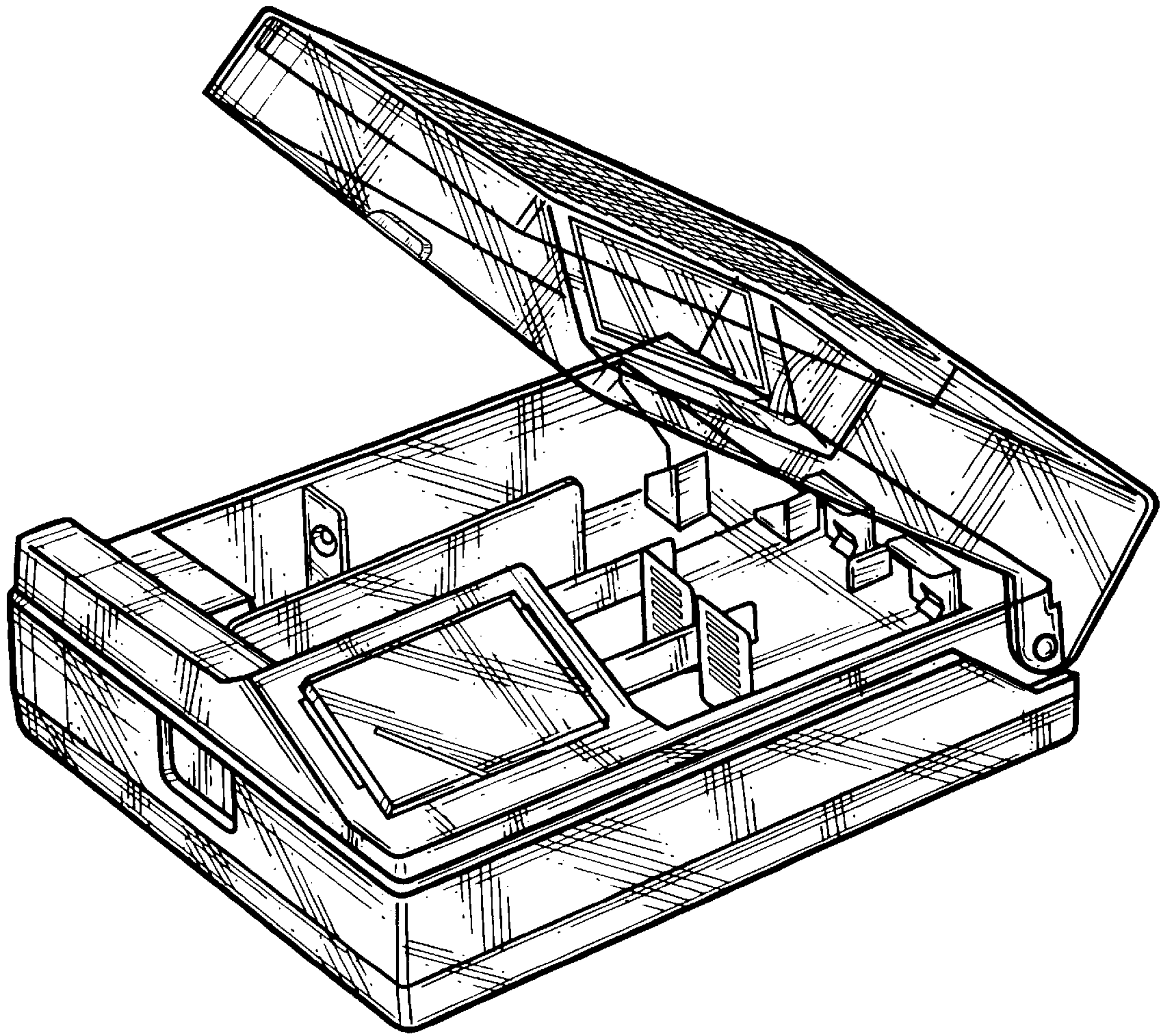
**FIG. 6**





**FIG. 7**





**FIG. 8**