



US00D399983S

United States Patent [19]

Cadotte et al.

[11] **Patent Number: Des. 399,983**

[45] **Date of Patent: **Oct. 20, 1998**

[54] **LAMP**

[76] Inventors: **Germain Cadotte**, 389 des Bois
Francs, St-élie d'Orford, Quebec,
Canada, JOB 250; **Martin Aube**, 3790
Monseigneur Moisan, Sherbrooke,
Quebec, Canada, J1L 2C1

[**] Term: **14 Years**

[21] Appl. No.: **79,077**

[22] Filed: **Nov. 7, 1997**

[51] **LOC (6) Cl.** **26-06**

[52] **U.S. Cl.** **D26/28**

[58] **Field of Search** D26/28-36; 362/61,
362/80, 81, 82, 83, 83.4, 267, 269, 275

[56] **References Cited**

U.S. PATENT DOCUMENTS

- D. 291,923 9/1987 Kawaguchi D26/28
- D. 323,899 2/1992 Za Pointe D26/28

- D. 388,897 1/1998 Tomforde et al. D26/28
- D. 389,256 1/1998 Sacco et al. D26/28
- 3,594,569 7/1971 Webster D26/28
- 4,586,116 4/1986 Kasboske D26/28

Primary Examiner—Marcus A. Jackson
Attorney, Agent, or Firm—St. Onge Steward Johnston &
Reens LLC

[57] **CLAIM**

We claim the ornamental design for a lamp, as shown and described.

DESCRIPTION

FIG. 1 is a front perspective view of a lamp embodying the design;
FIG. 2 is a top plan view of the lamp of FIG. 1;
FIG. 3 is a right elevational view of the lamp of FIG. 1;
FIG. 4 is left elevational view of the lamp of FIG. 1;
FIG. 5 is front elevational view of the lamp of FIG. 1;
FIG. 6 is a bottom plan view of the lamp of FIG. 1; and,
FIG. 7 is a rear elevational view of the lamp of FIG. 1.

1 Claim, 2 Drawing Sheets

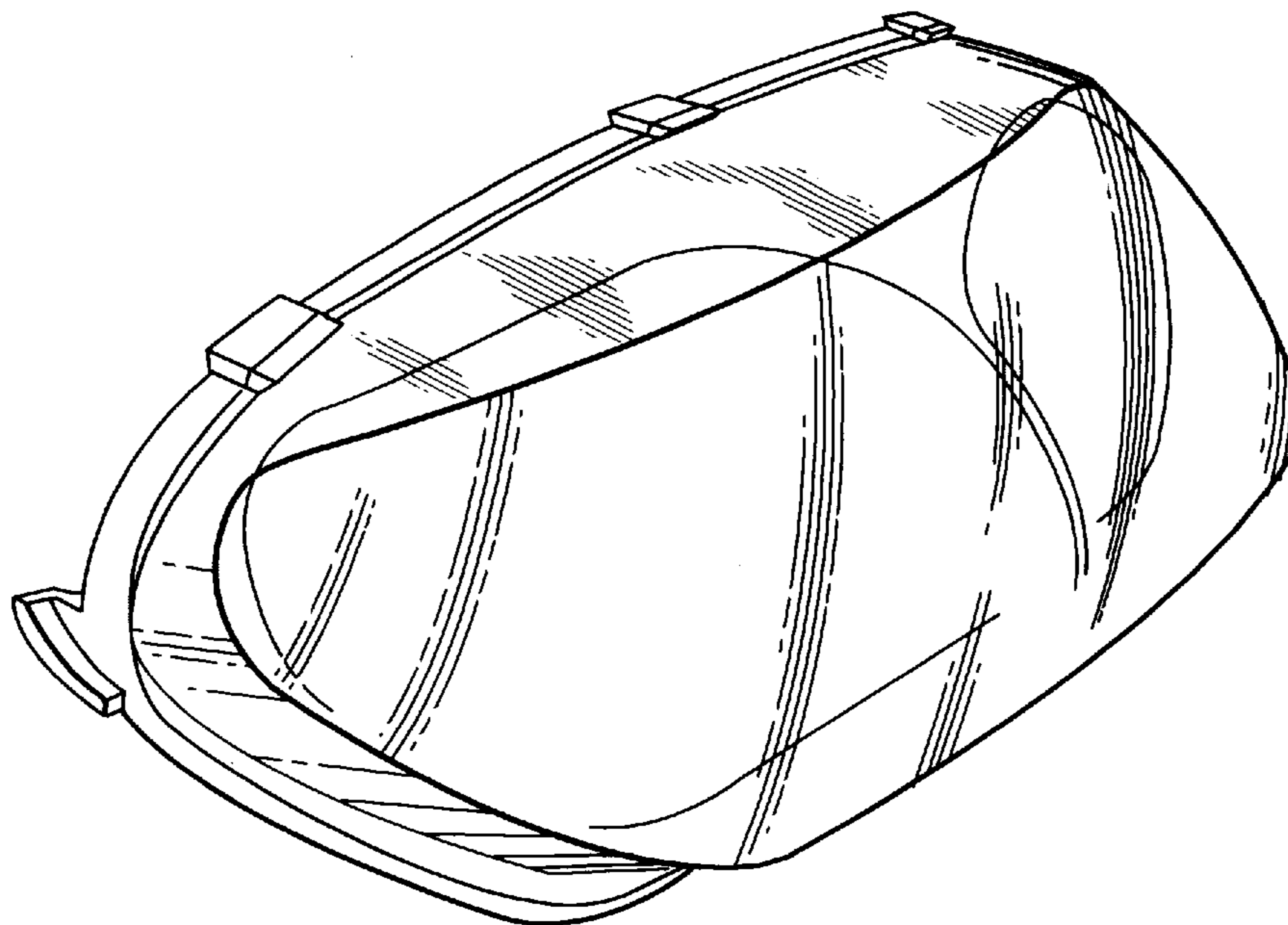

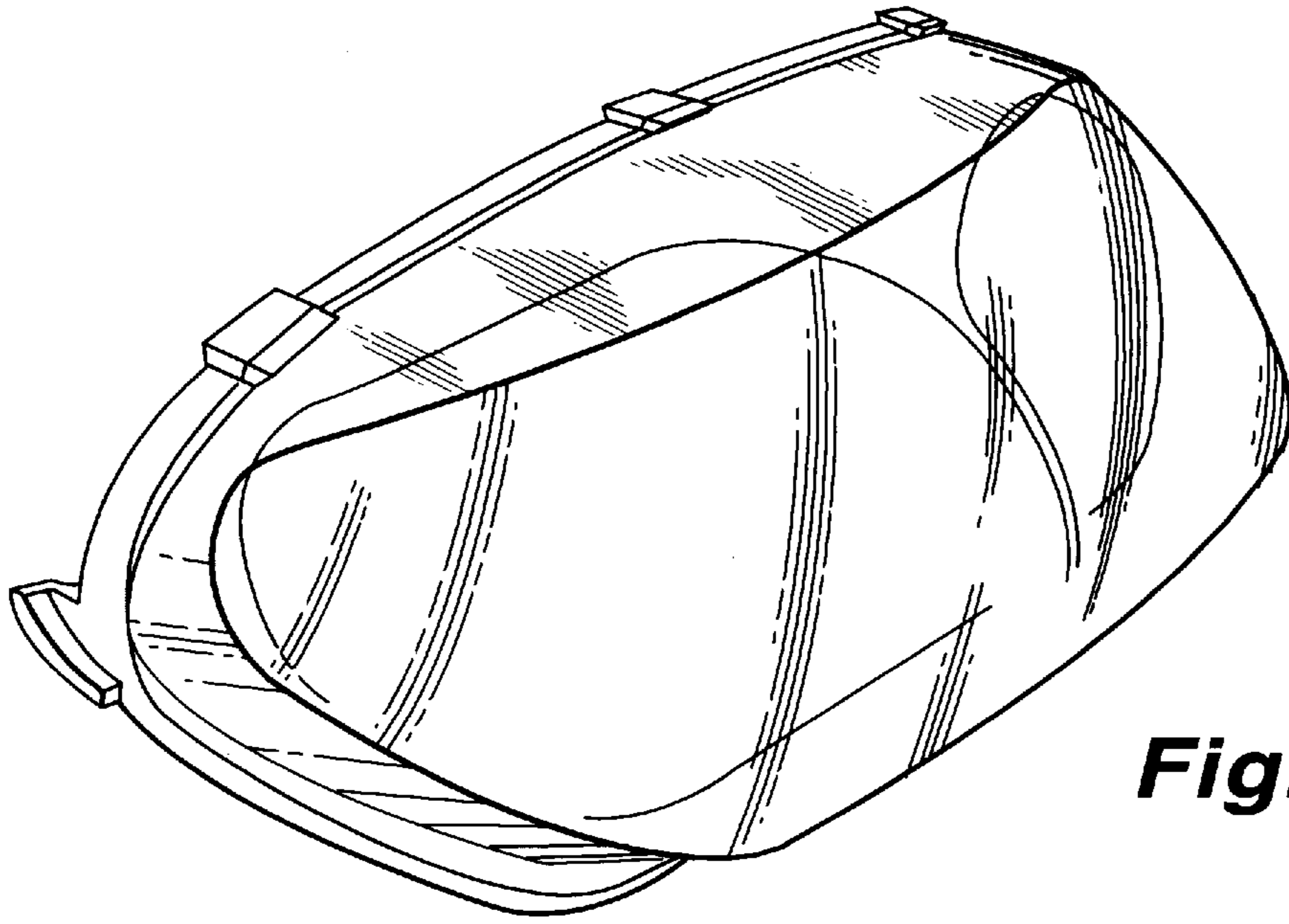

Fig. 1

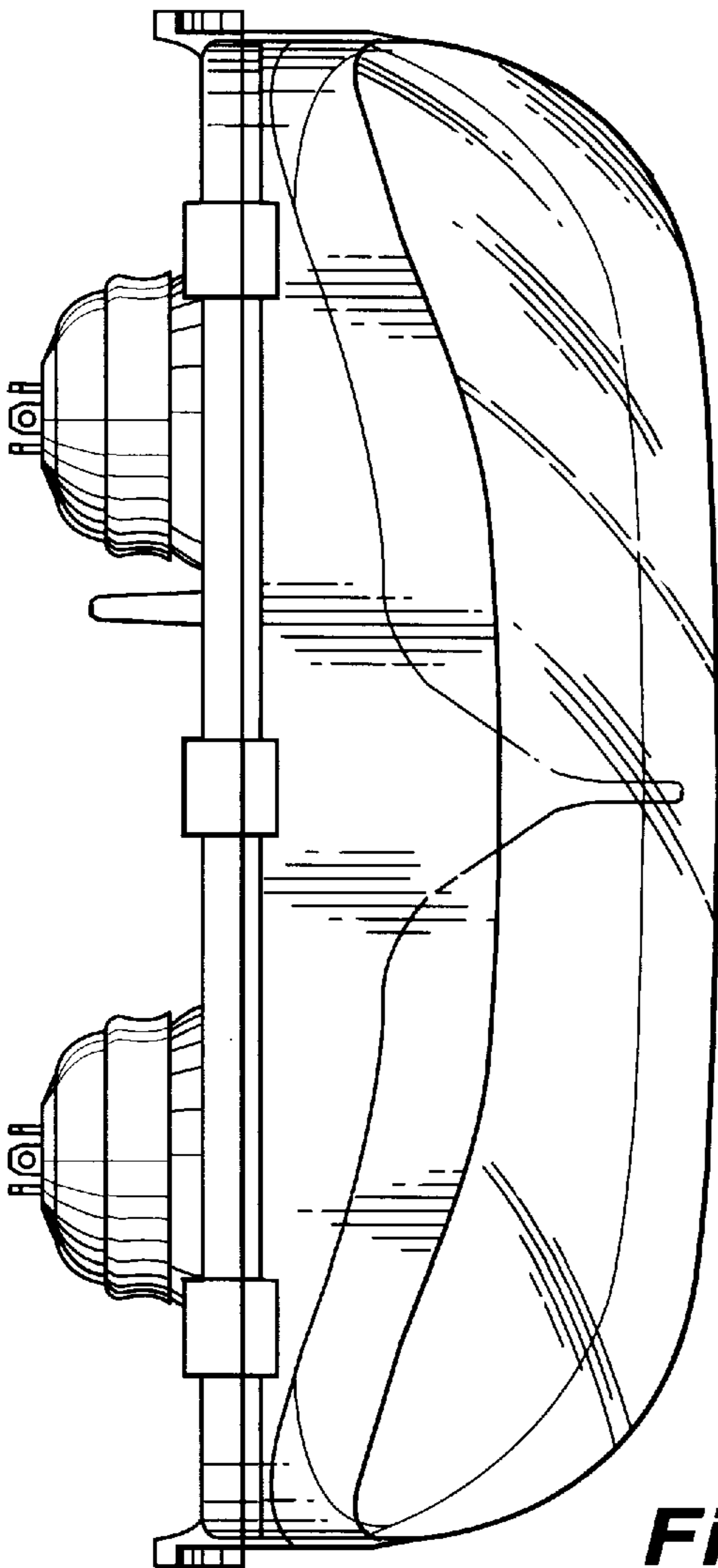

Fig. 2

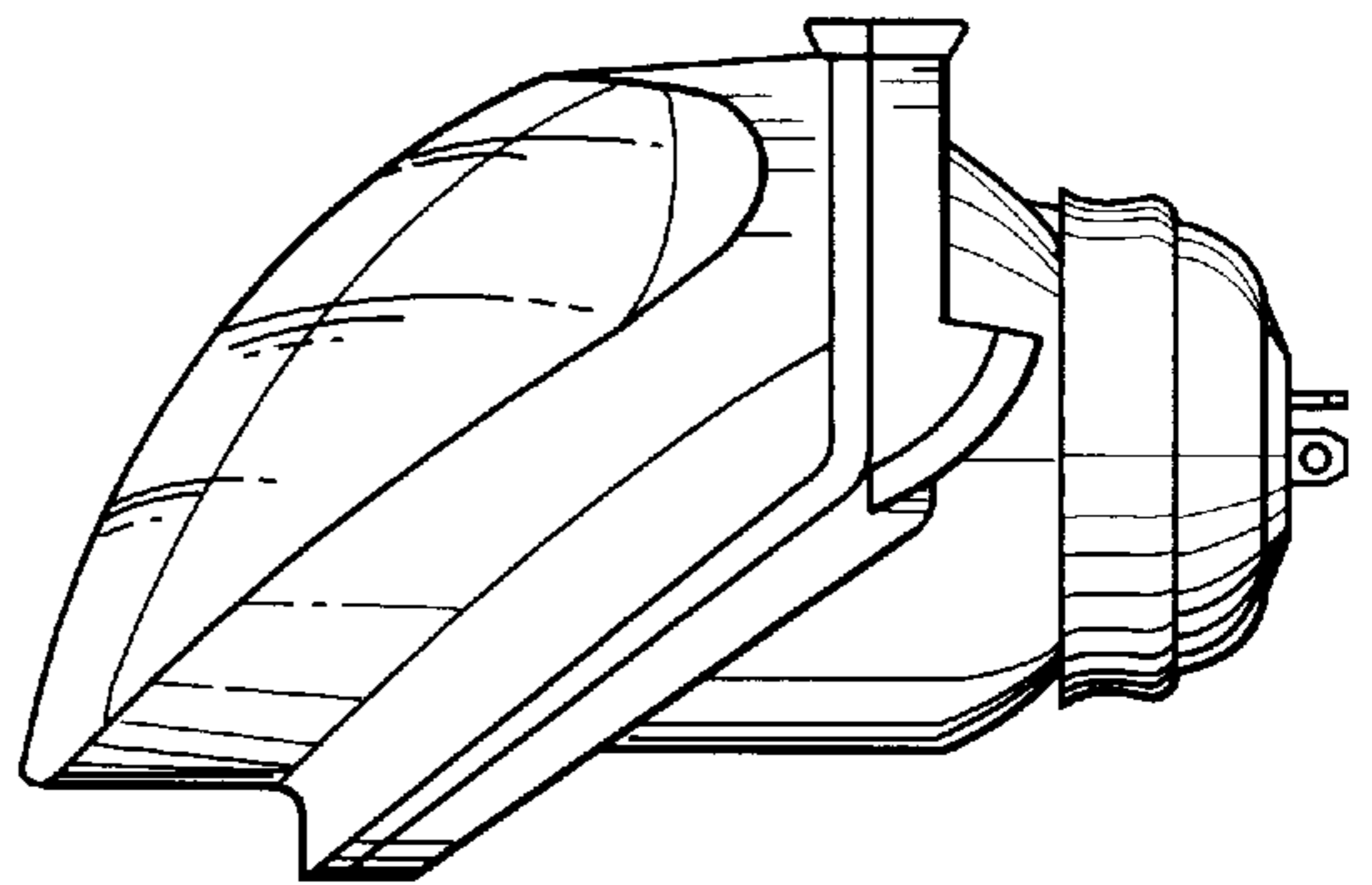

Fig. 3

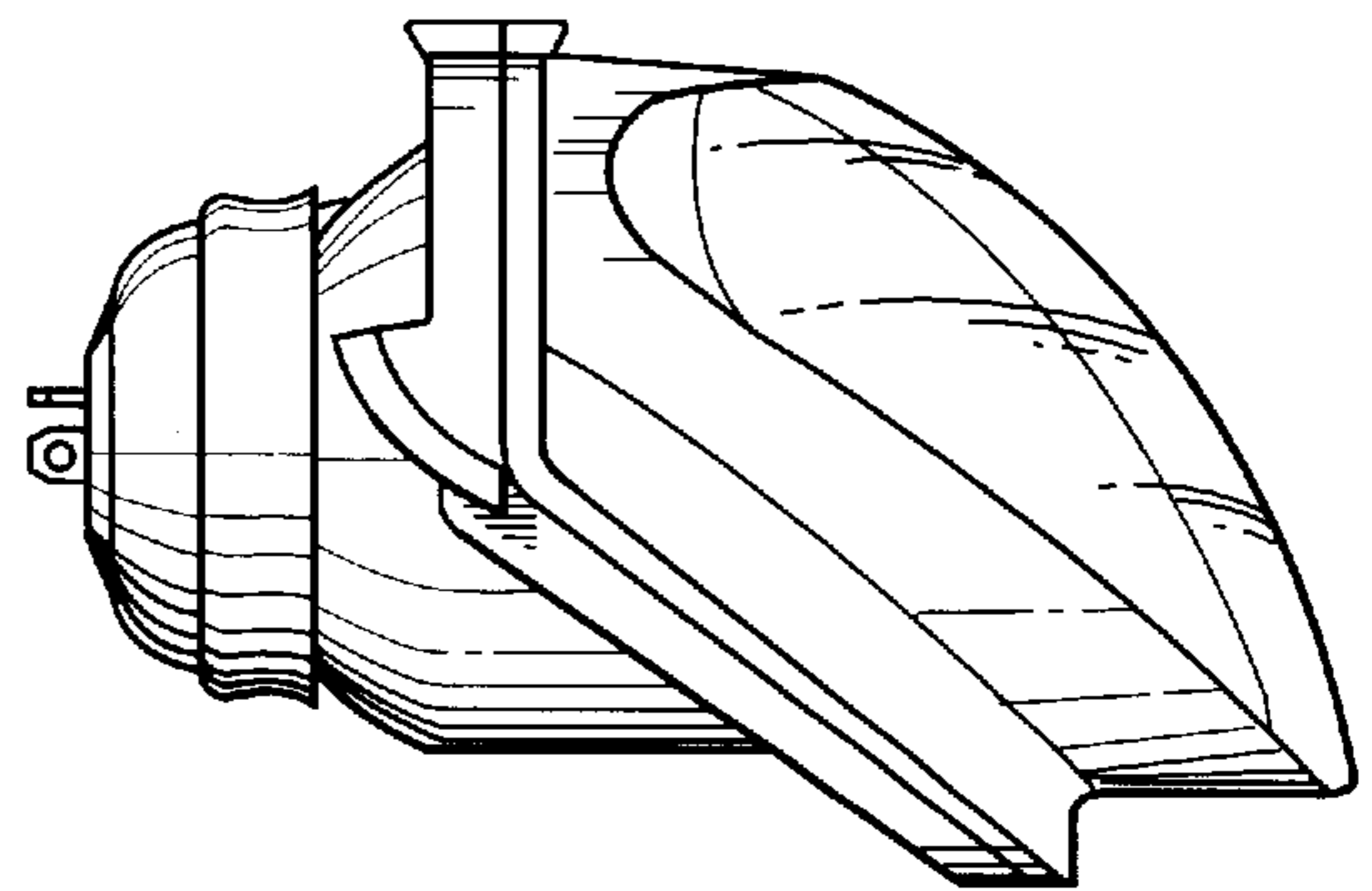

Fig. 4

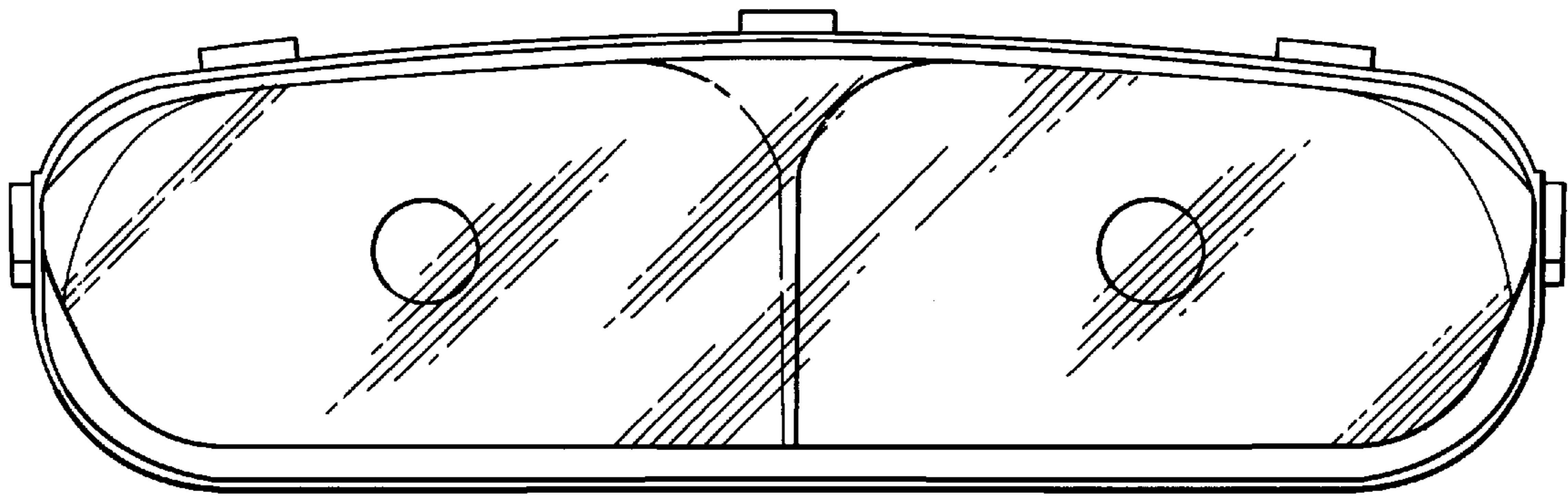

Fig. 5

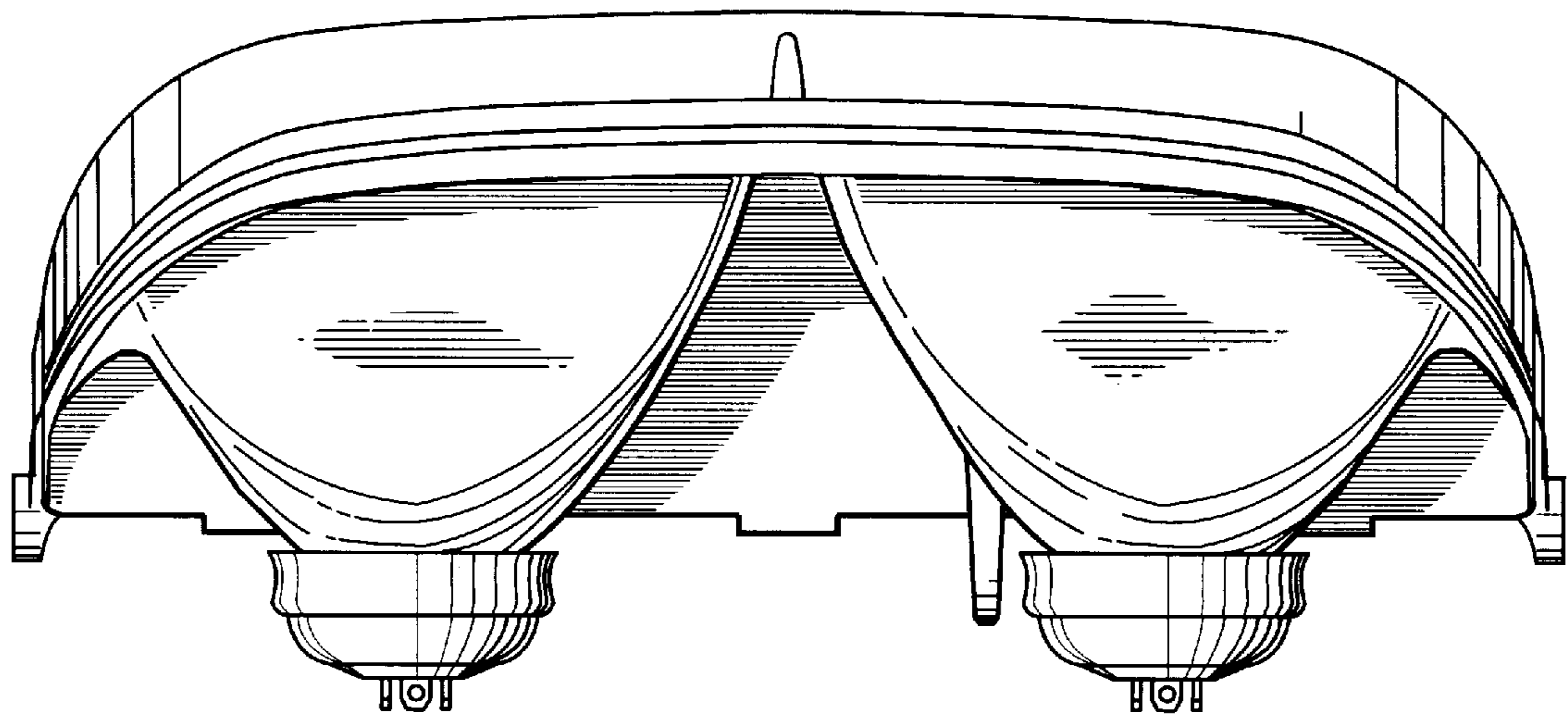

Fig. 6

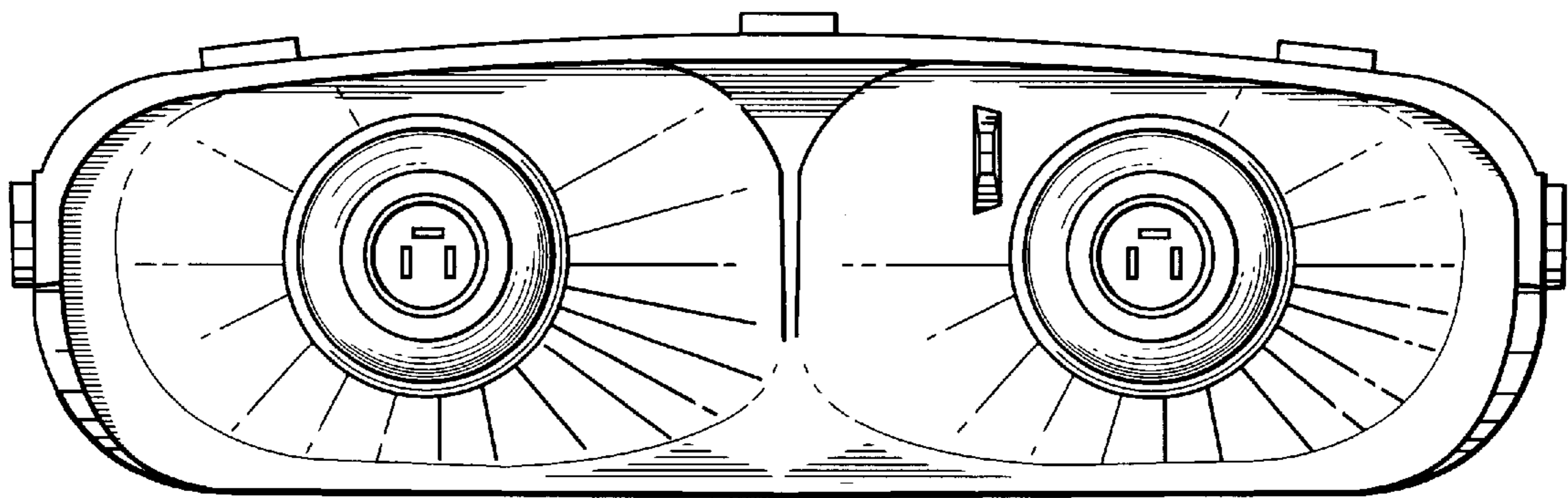

Fig. 7