



US00D399946S

United States Patent [19]
Horng

[11] **Patent Number: Des. 399,946**

[45] **Date of Patent: **Oct. 20, 1998**

[54] **HEAT DISSIPATION FAN**

[75] Inventor: **Alex Horng**, Kaohsiung, Taiwan

[73] Assignee: **Sunonwealth Electric Machine Industry Co., Ltd.**, Taiwan

[**] Term: **14 Years**

[21] Appl. No.: **77,605**

[22] Filed: **Oct. 7, 1997**

[51] **LOC (6) Cl.** **23-04**

[52] **U.S. Cl.** **D23/370**

[58] **Field of Search** D23/370, 379;
415/176, 177, 178, 211.2; 361/697, 695;
165/80.3, 121; D14/114

[56] **References Cited**

U.S. PATENT DOCUMENTS

5,079,438	1/1992	Heung	361/695
5,638,895	6/1997	Dodson	361/697
5,689,404	11/1997	Katsui	361/697
5,690,468	11/1997	Hong	361/697

FOREIGN PATENT DOCUMENTS

3408139	9/1985	Germany	361/695
---------	--------	---------	---------

Primary Examiner—Lisa Lichtenstein
Attorney, Agent, or Firm—Cushman Darby & Cushman IP Group of Pillsbury Madison & Sutro LLP

[57] **CLAIM**

The ornamental design for a heat dissipation fan, as shown and described.

DESCRIPTION

FIG. 1 is a perspective view of the heat dissipation fan in accordance with the first embodiment of the claimed design; FIG. 2 is a top plan view thereof; FIG. 3 is a right side elevational view thereof; FIG. 4 is a front elevational view thereof; FIG. 5 is a rear elevational view thereof; FIG. 6 is a left side elevational view thereof; FIG. 7 is a bottom plan view thereof; FIG. 8 is a perspective view of the heat dissipation fan in accordance with the second embodiment of the claimed design; FIG. 9 is a top plan view of FIG. 8; FIG. 10 is a right side elevational view of FIG. 8; FIG. 11 is a front elevational view of FIG. 8; FIG. 12 is a rear elevational view of FIG. 8; FIG. 13 is a left side elevational view of FIG. 8; and, FIG. 14 is a bottom plan view of FIG. 8.

1 Claim, 8 Drawing Sheets

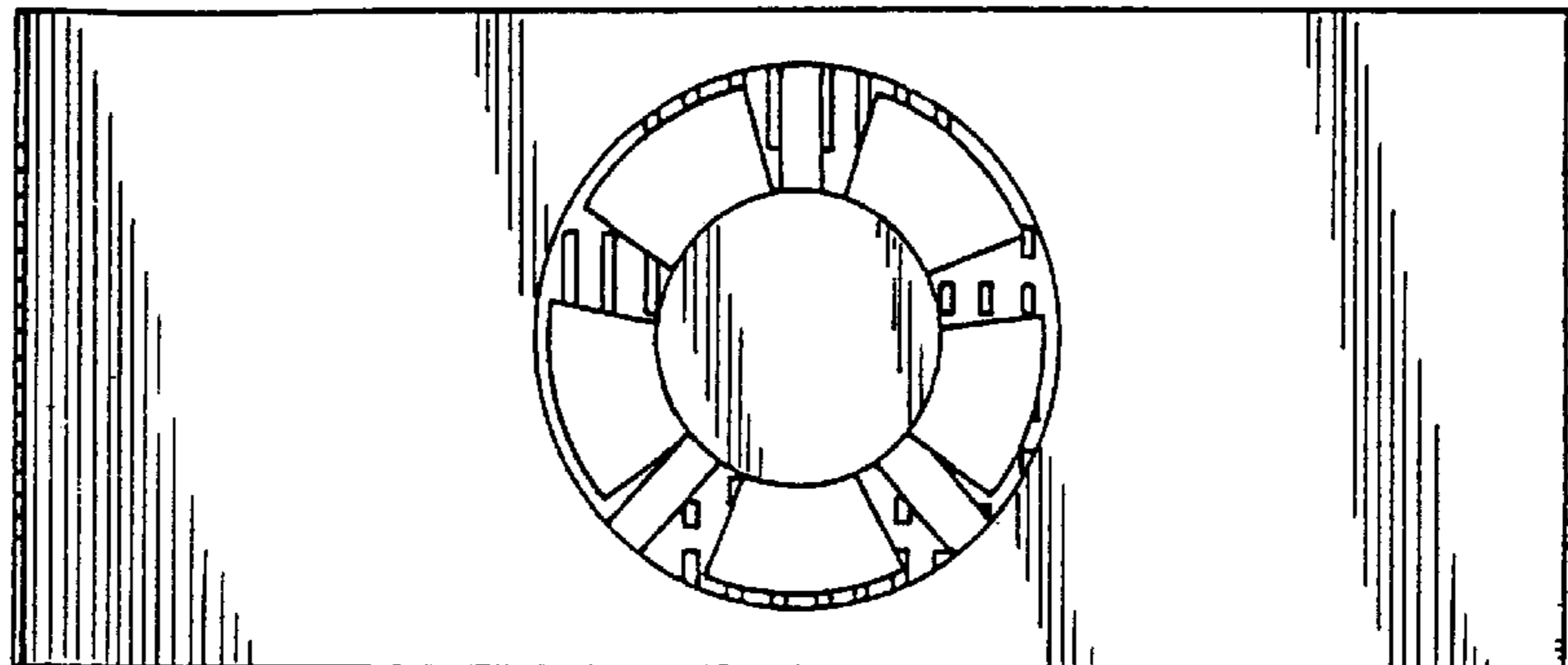
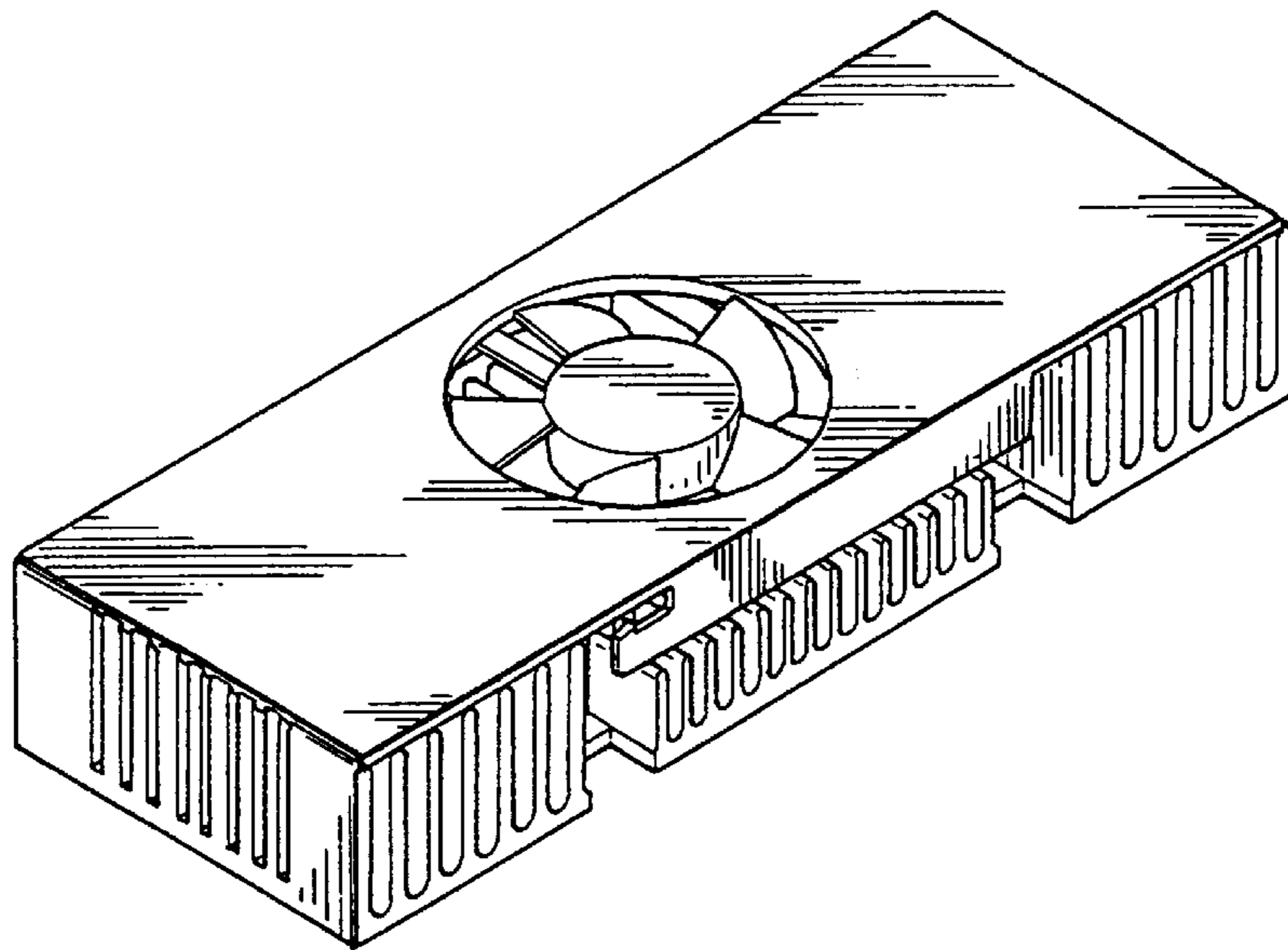

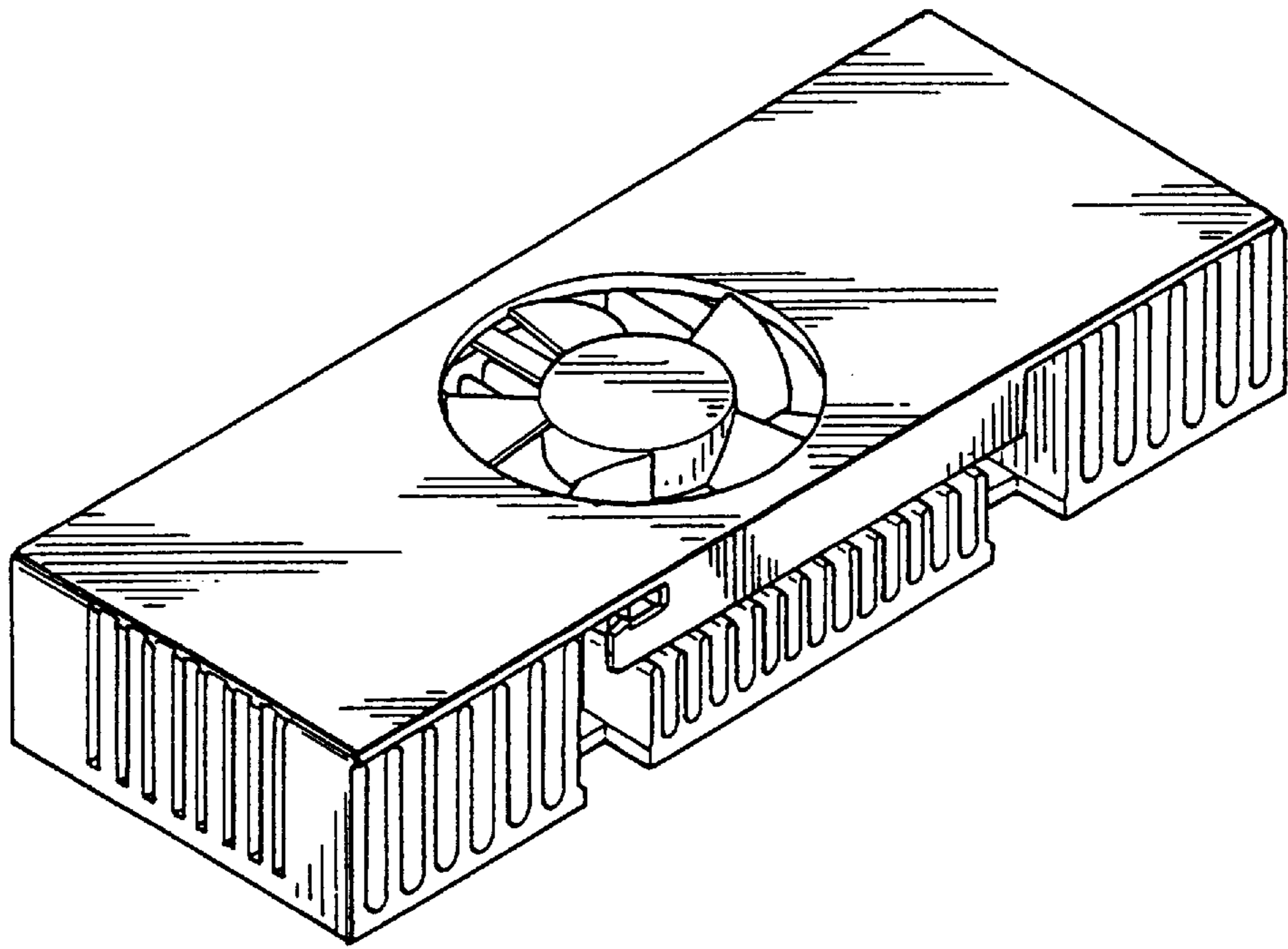

FIG.1

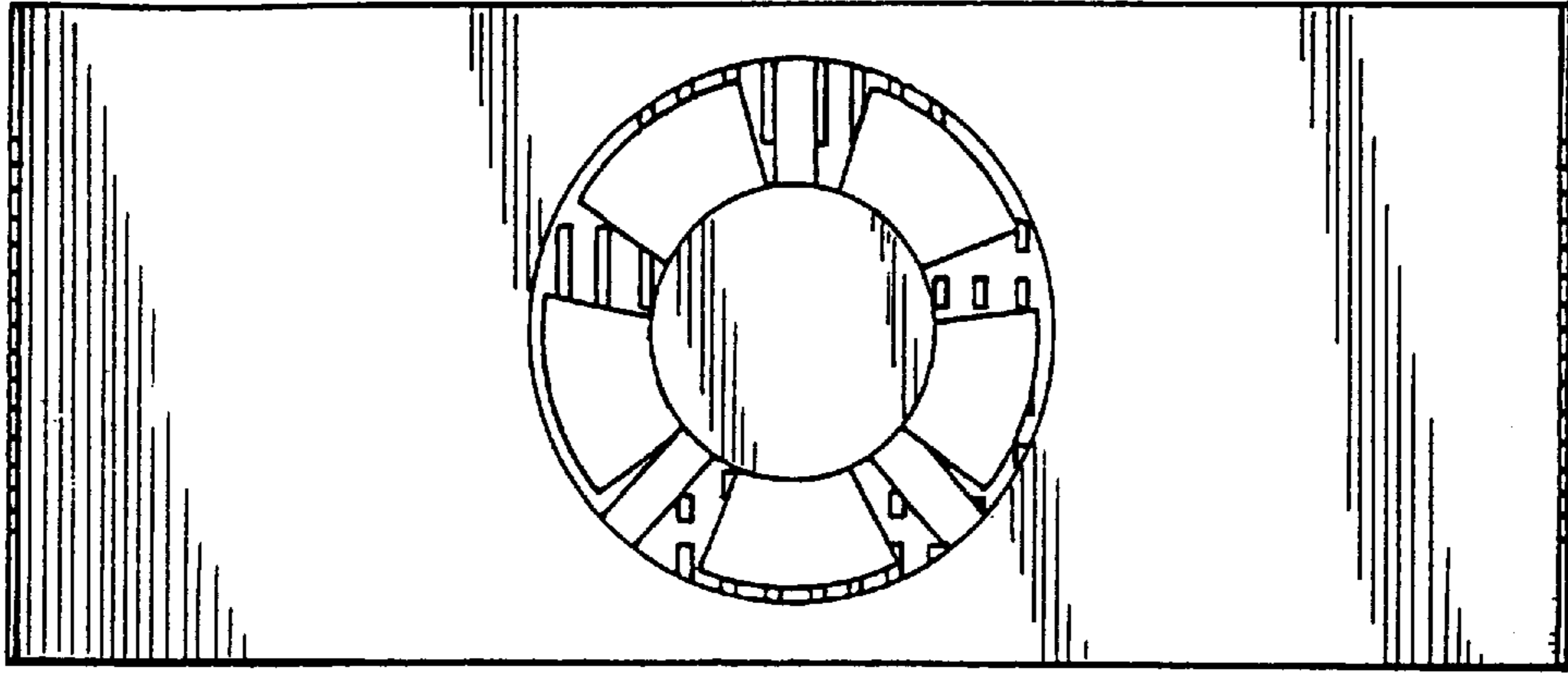

FIG. 2

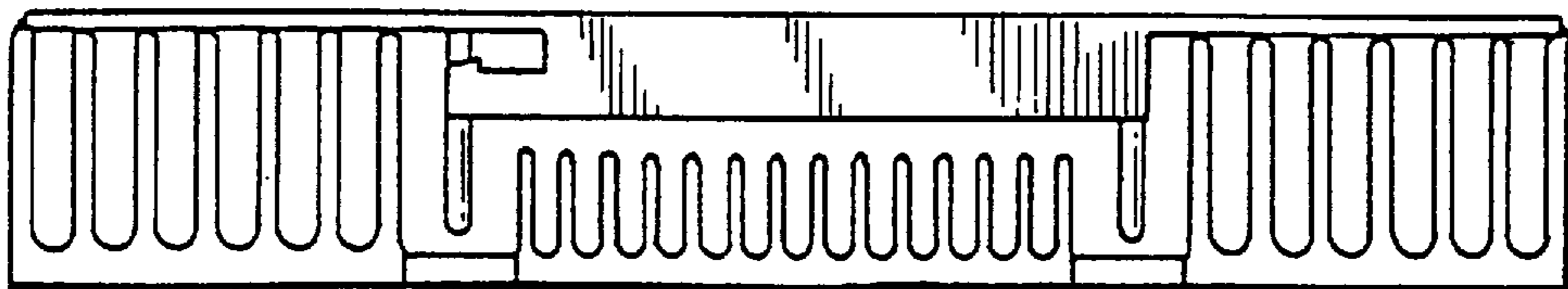

FIG. 3

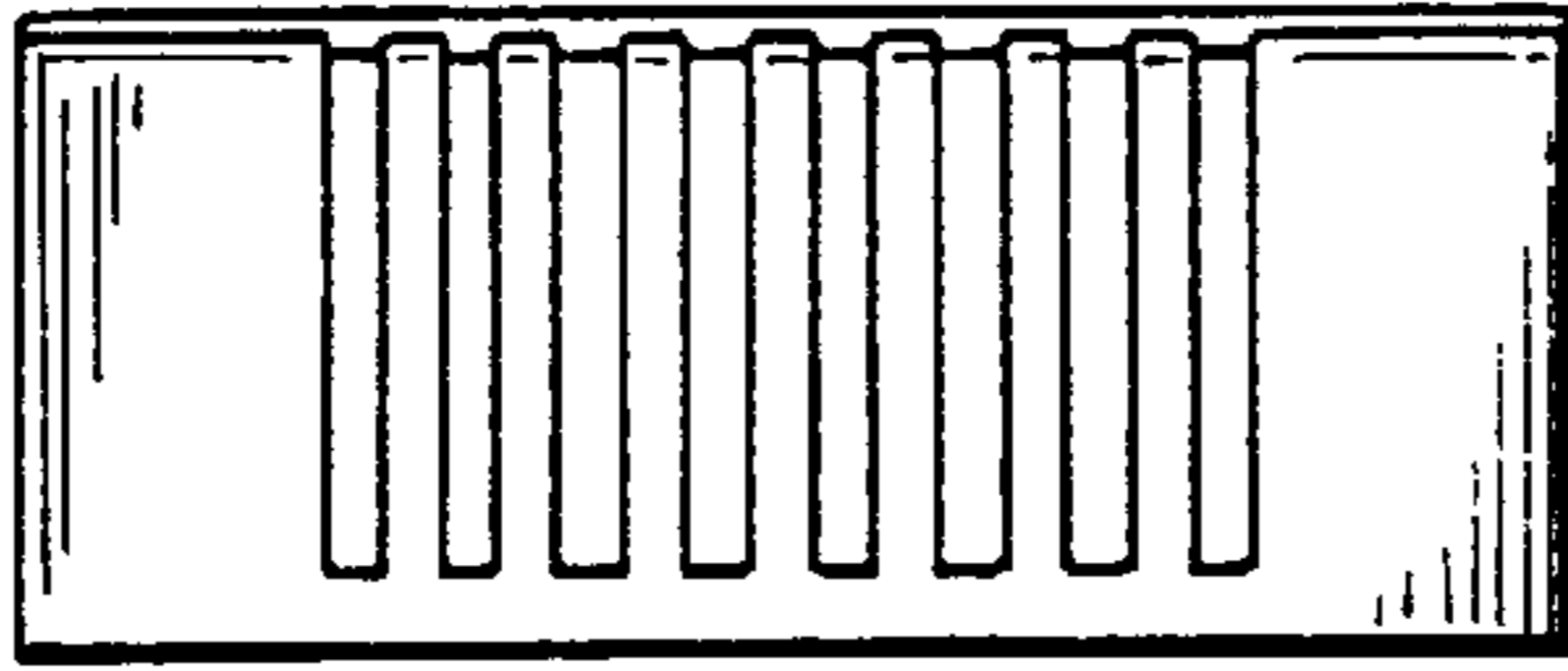

FIG. 4

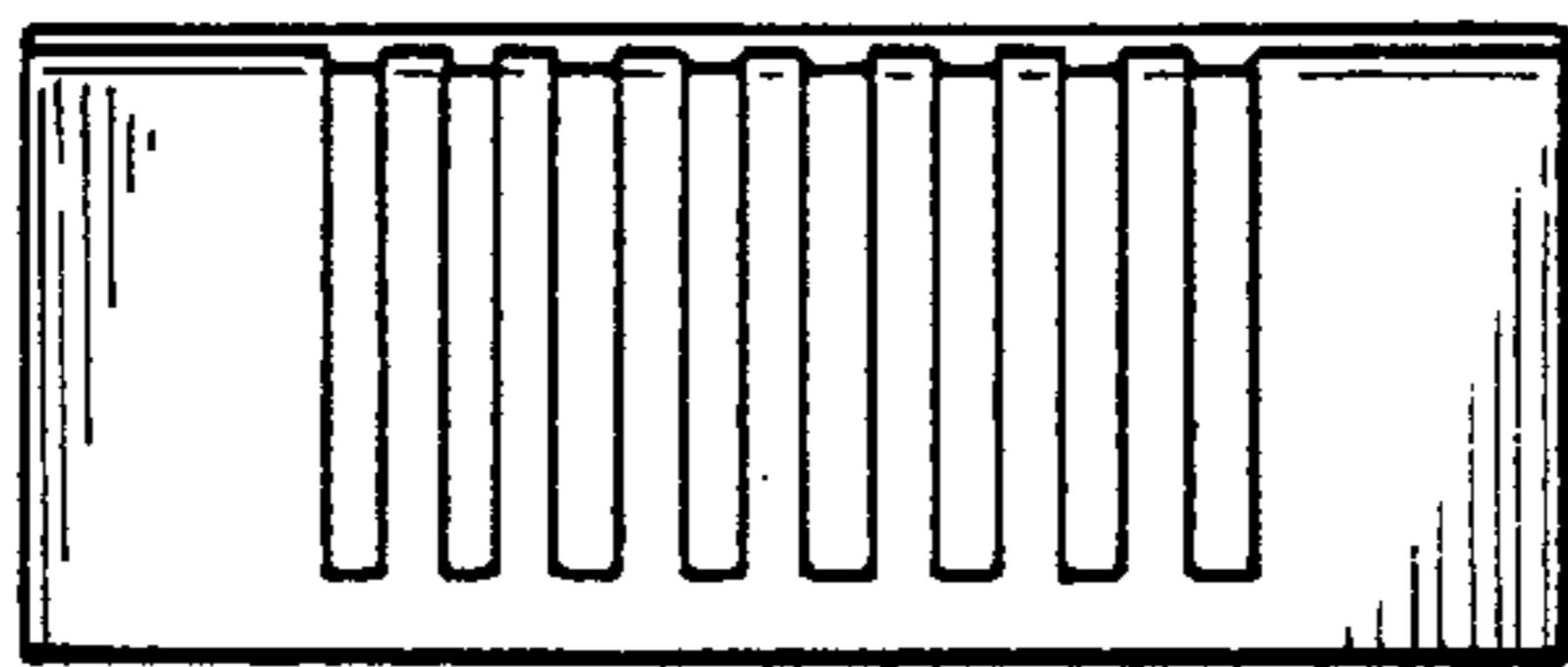

FIG. 5

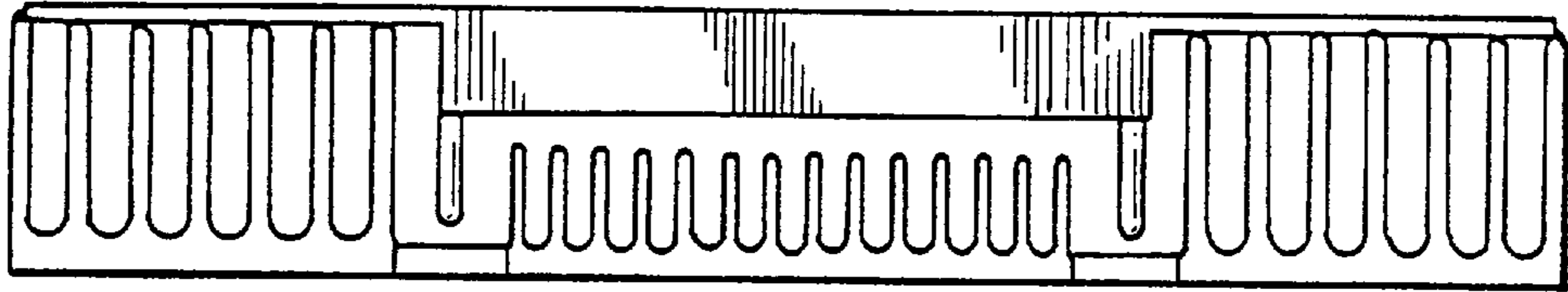

FIG. 6

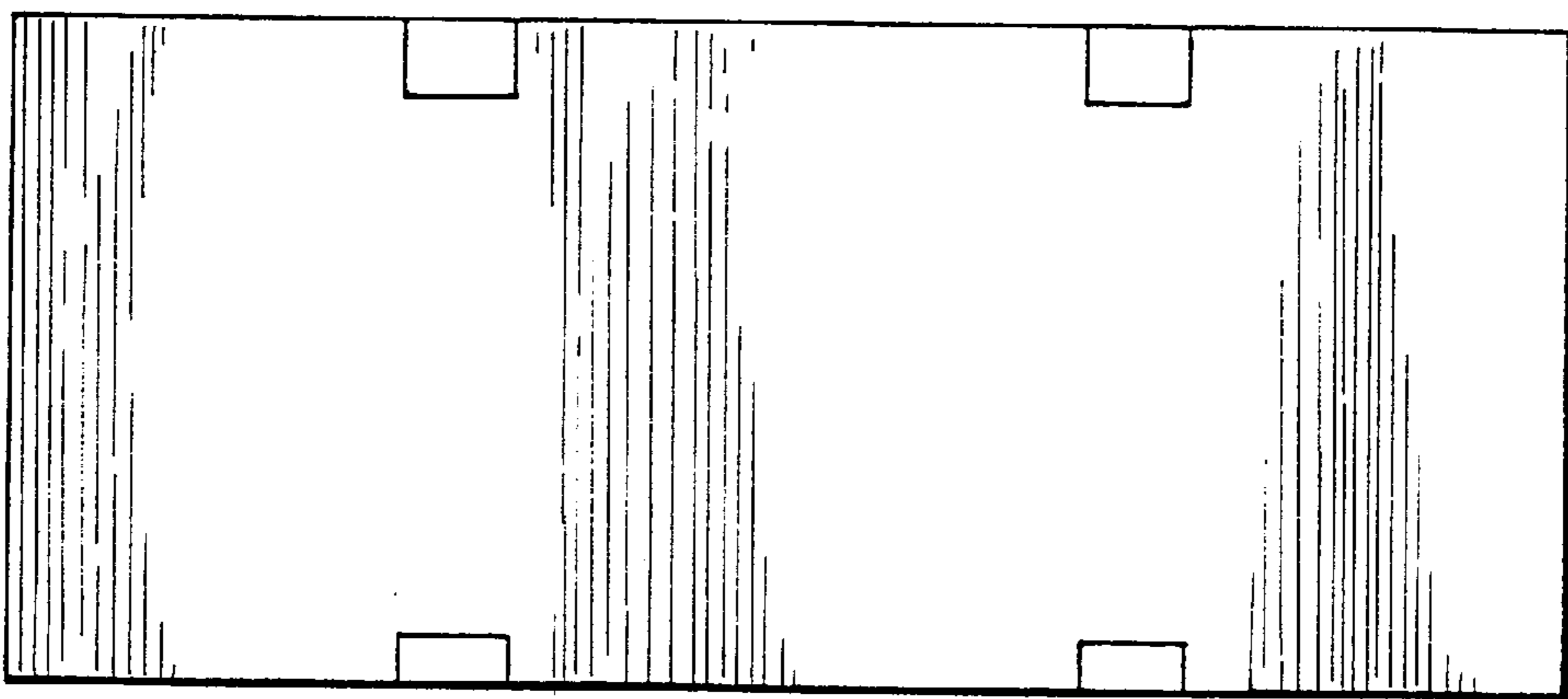

FIG. 7

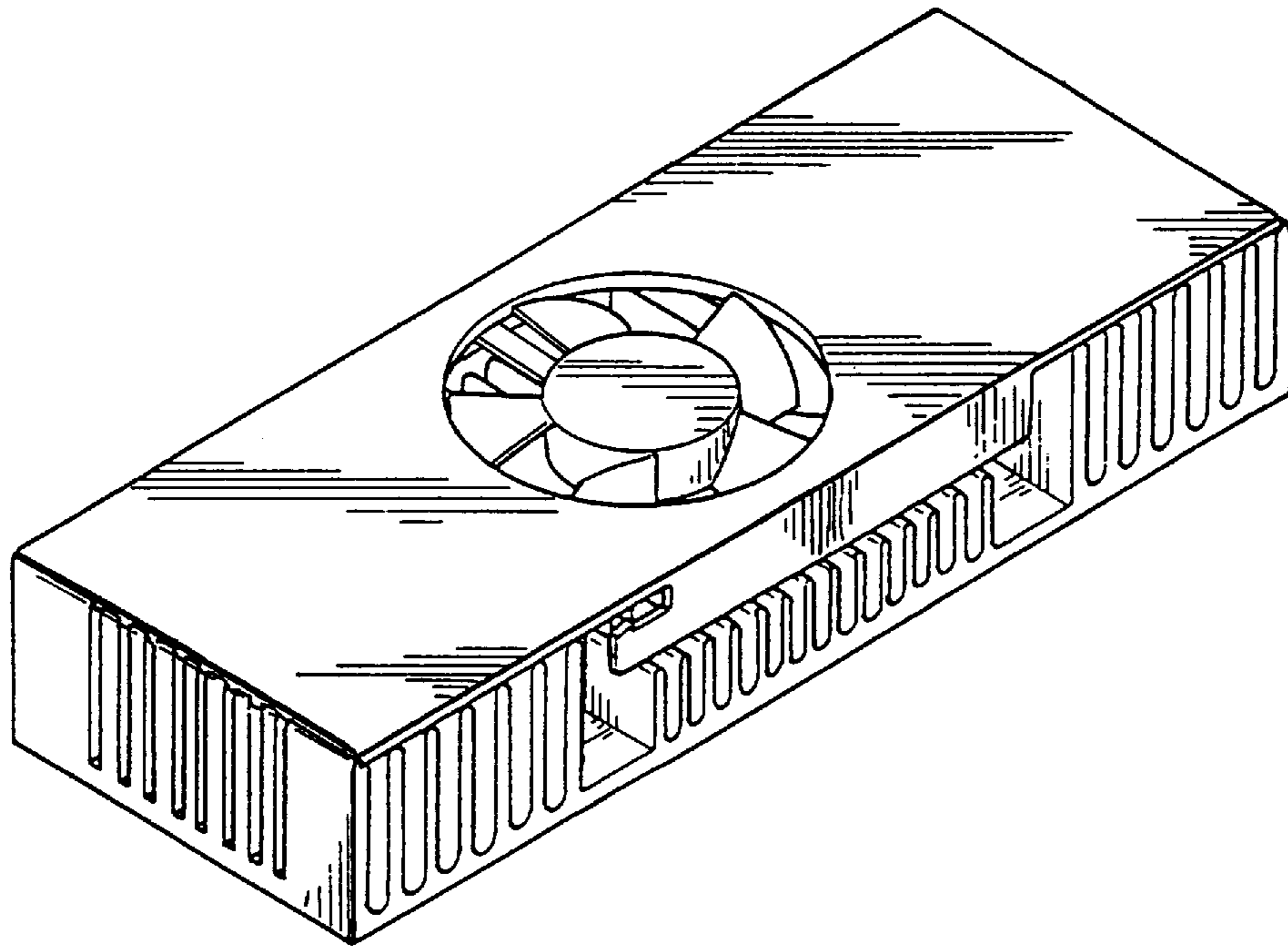

FIG.8

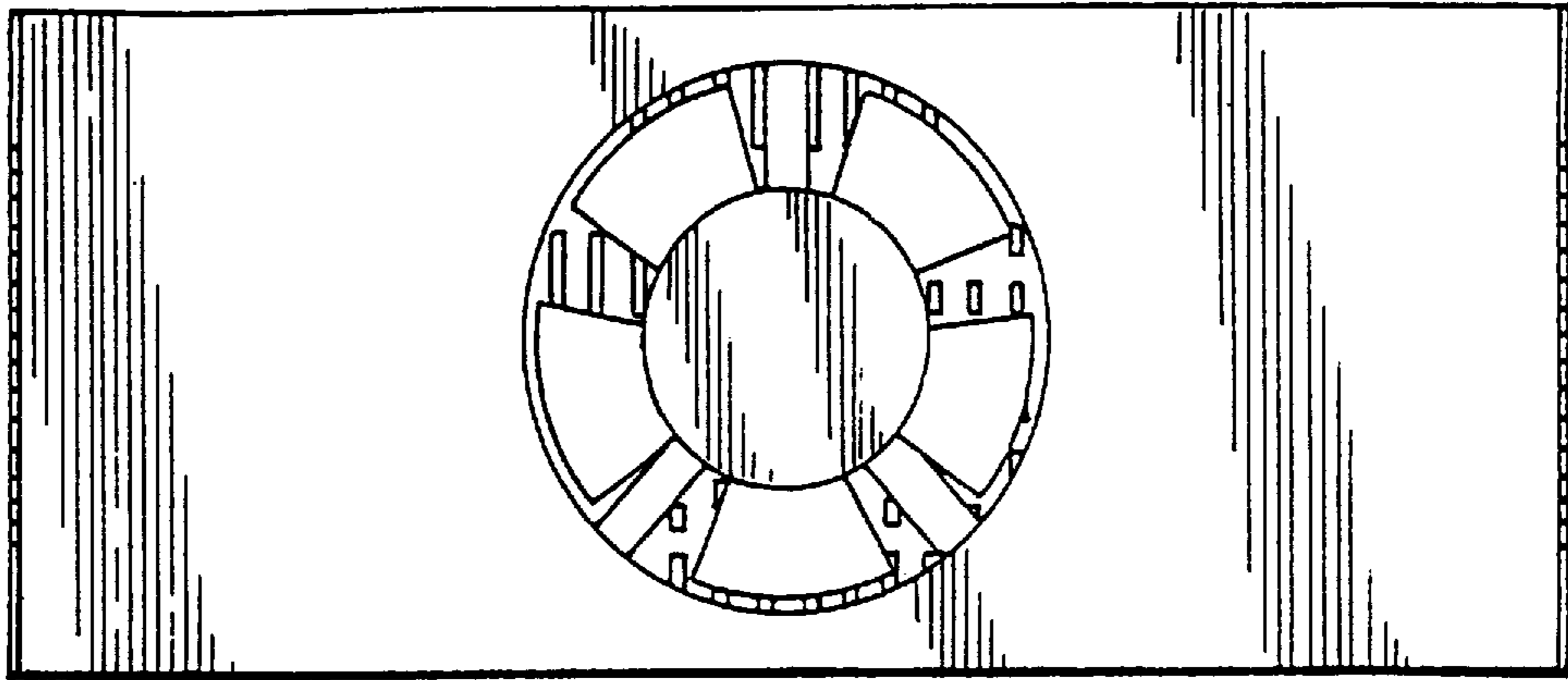

FIG. 9

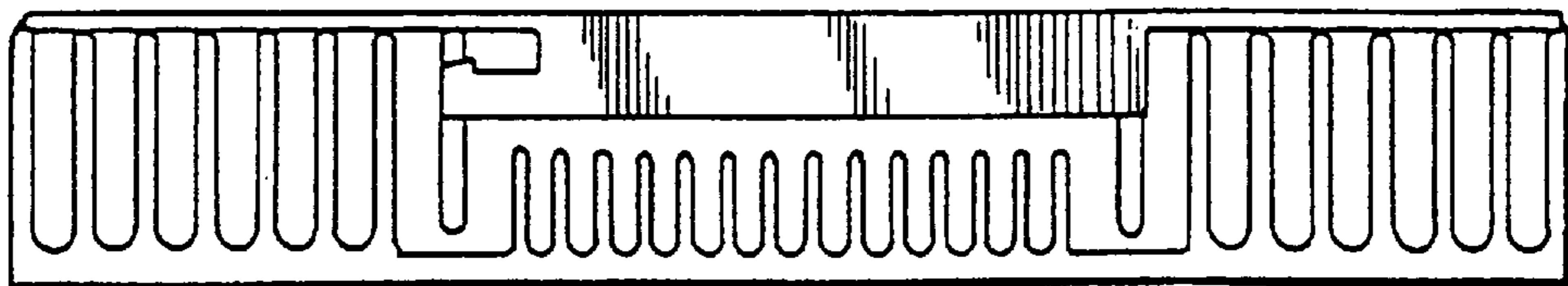

FIG. 10

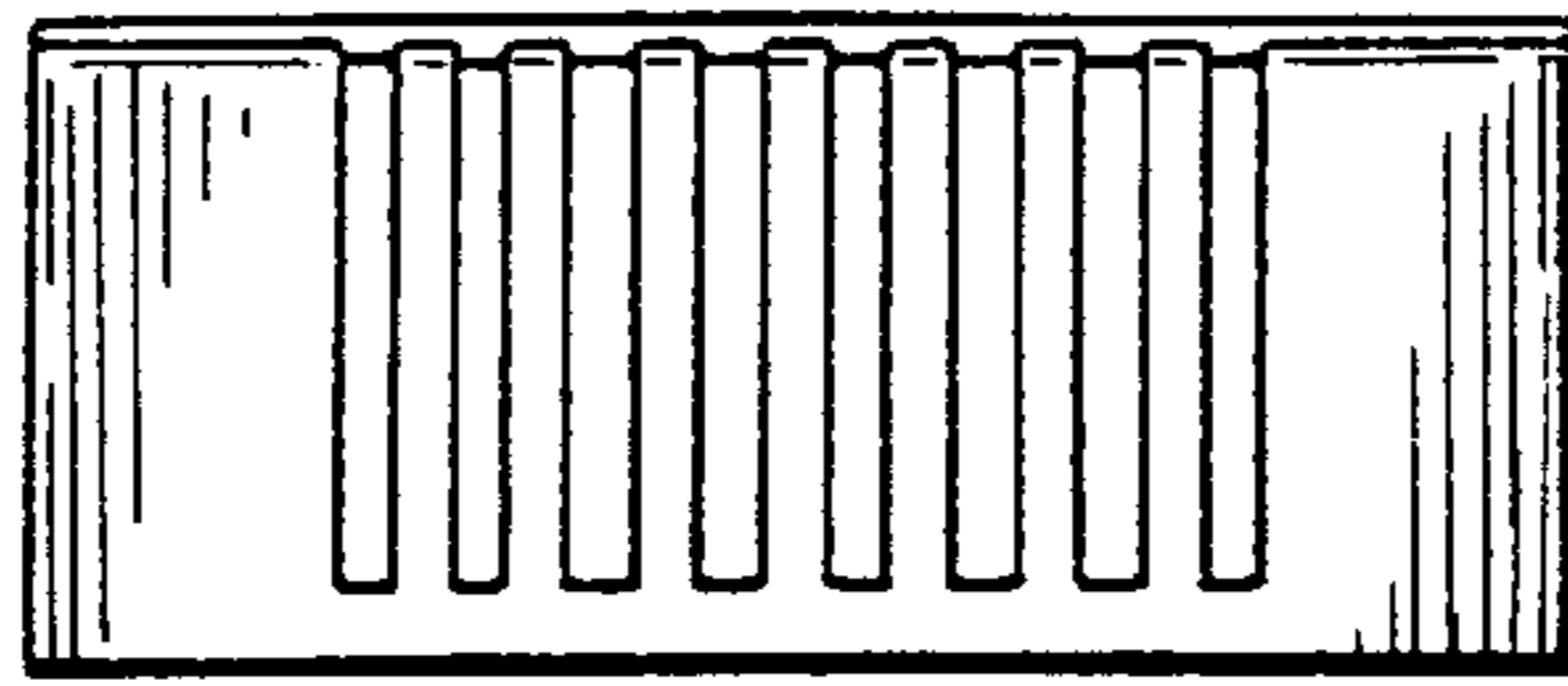

FIG. 11

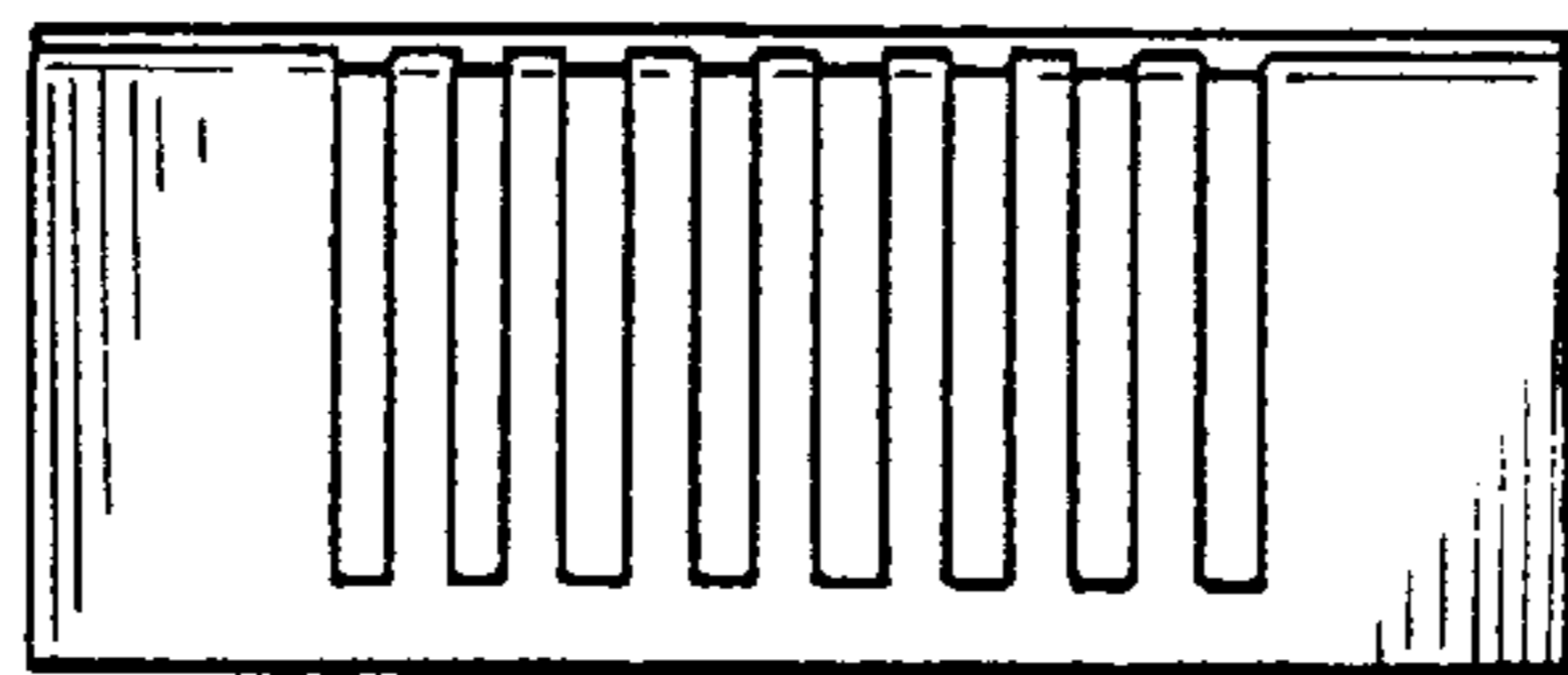

FIG. 12

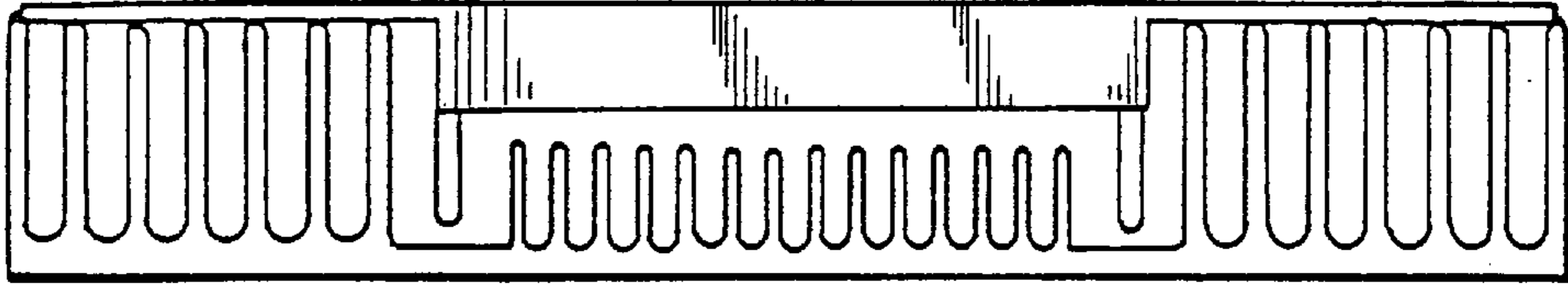

FIG. 13

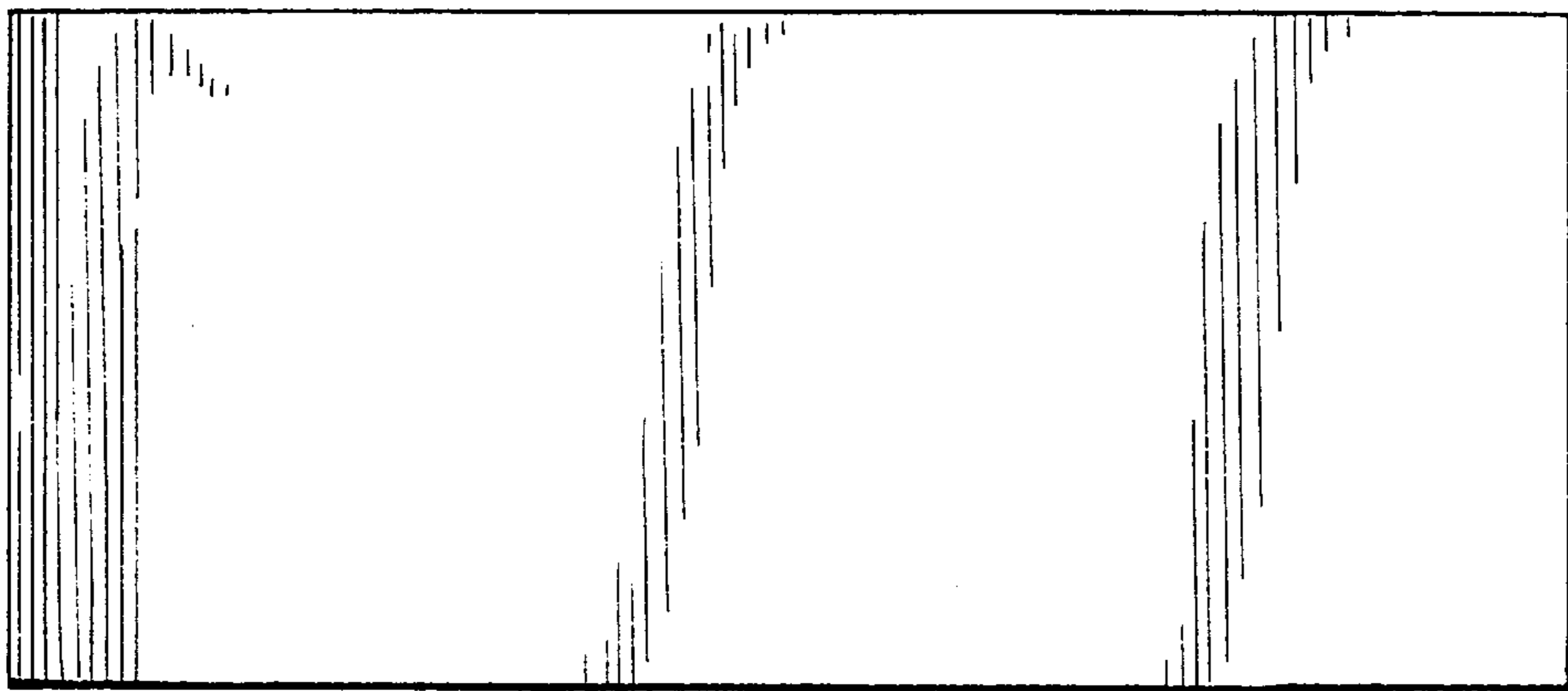

FIG. 14