



US00D399918S

United States Patent [19]
Huen

[11] **Patent Number: Des. 399,918**

[45] **Date of Patent: **Oct. 20, 1998**

[54] **HAND-HELD SHOWER HEAD**

[75] Inventor: **Hing Wah Huen**, Hong Kong, Hong Kong

[73] Assignee: **Oasis Global Limited**, Kowloon, Hong Kong

[**] Term: **14 Years**

[21] Appl. No.: **78,273**

[22] Filed: **Oct. 23, 1997**

[51] **LOC (6) Cl.** **23-01**

[52] **U.S. Cl.** **D23/223**

[58] **Field of Search** D23/213, 223-230;
239/394, 459, 460, 461

[56] **References Cited**

U.S. PATENT DOCUMENTS

D. 381,737 7/1997 Chan D23/223

D. 385,947 11/1997 Dow et al. D23/223

Primary Examiner—Alan P. Douglas
Assistant Examiner—Robin V. Taylor
Attorney, Agent, or Firm—Salter & Michaelson

[57] **CLAIM**

The ornamental design for a hand-held shower head, as shown.

DESCRIPTION

FIG. 1 is a front elevational view of a hand-held shower head showing my new design;
FIG. 2 is a rear elevational view thereof;
FIG. 3 is a left side elevational view thereof;
FIG. 4 is a right side elevational view thereof;
FIG. 5 is a top plan view thereof;
FIG. 6 is a bottom plan view thereof; and,
FIG. 7 is a perspective view of thereof.

1 Claim, 3 Drawing Sheets

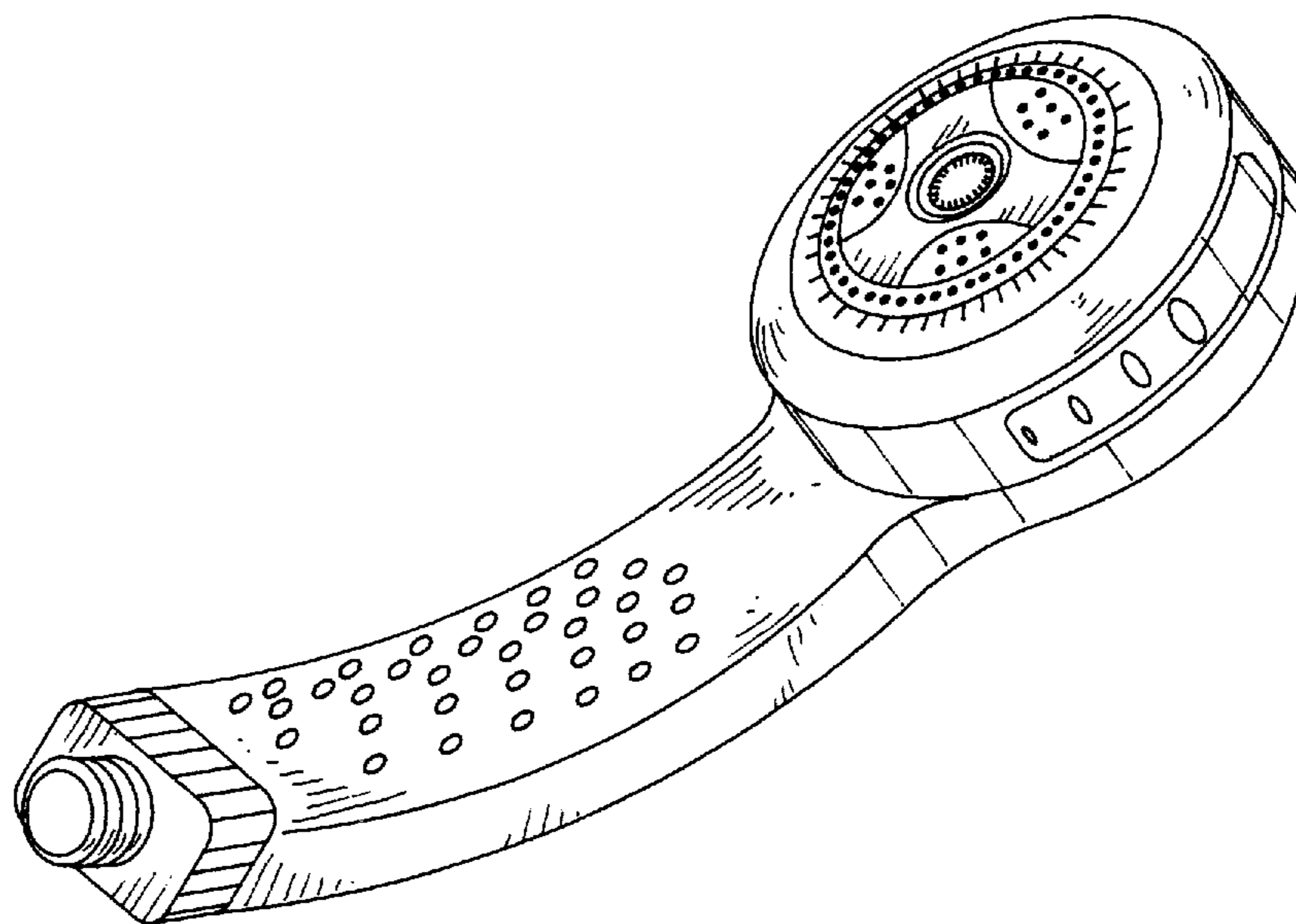

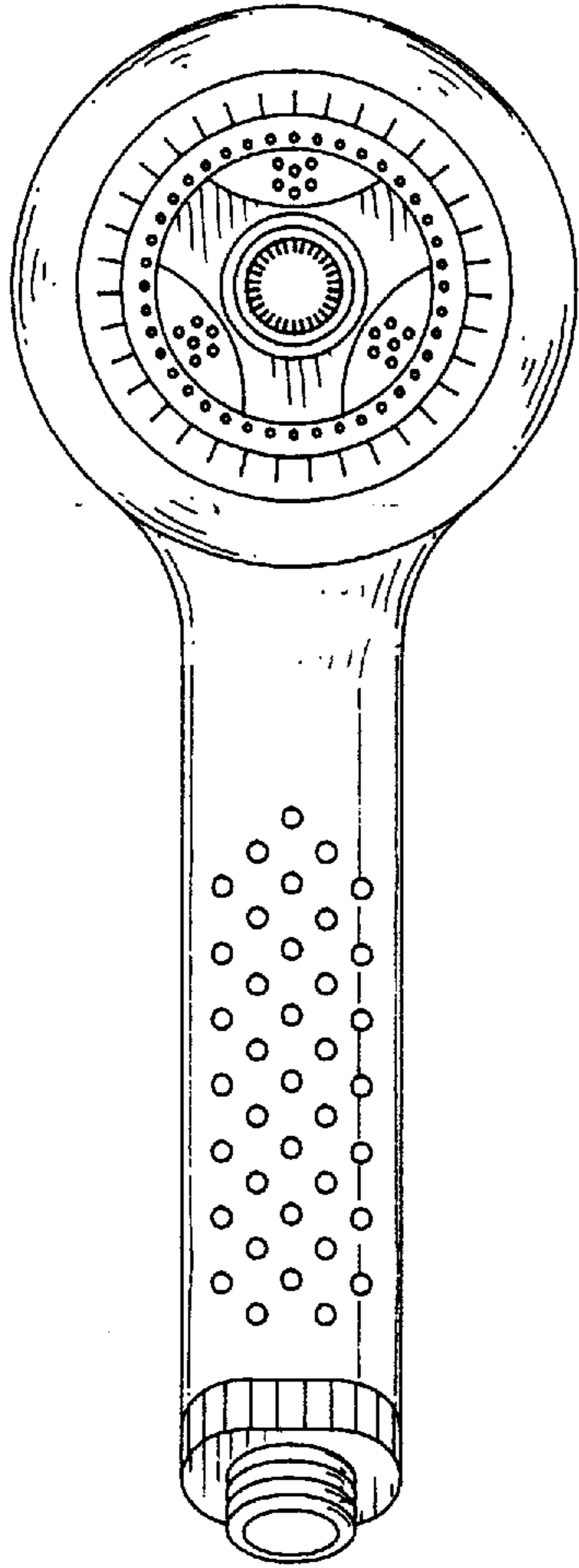

FIG. 1

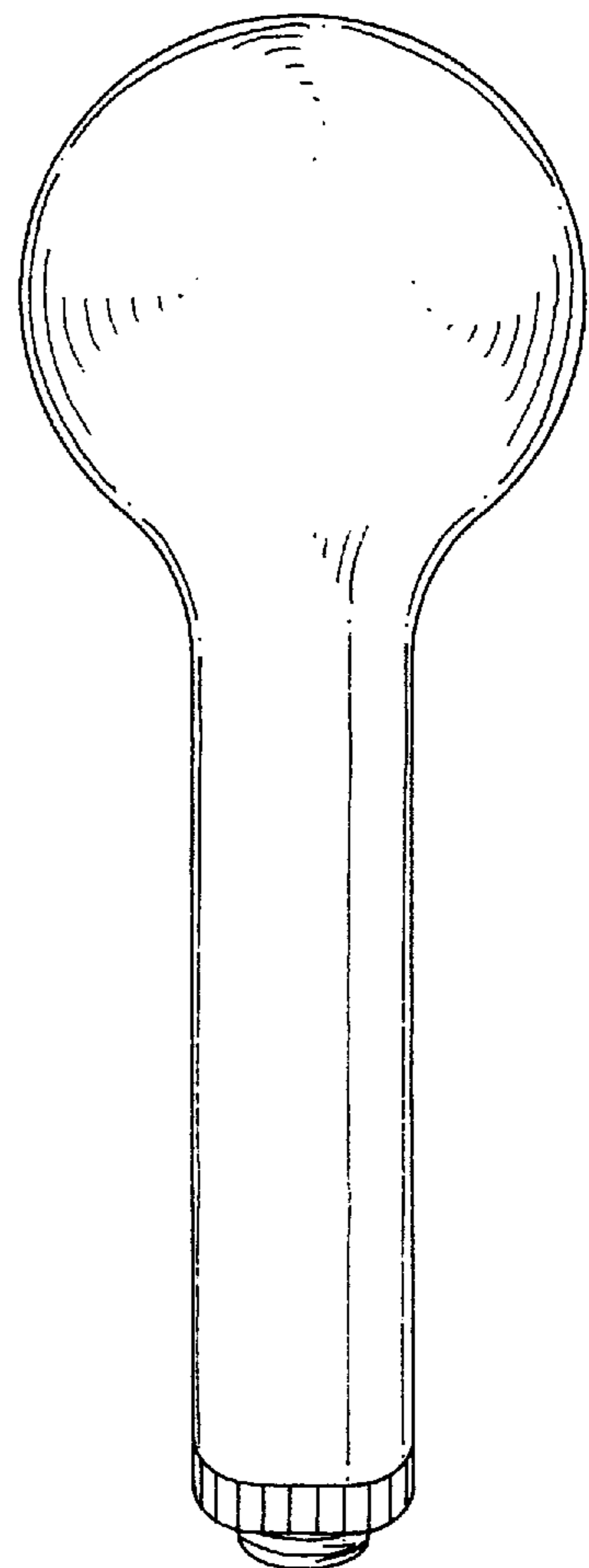

FIG. 2

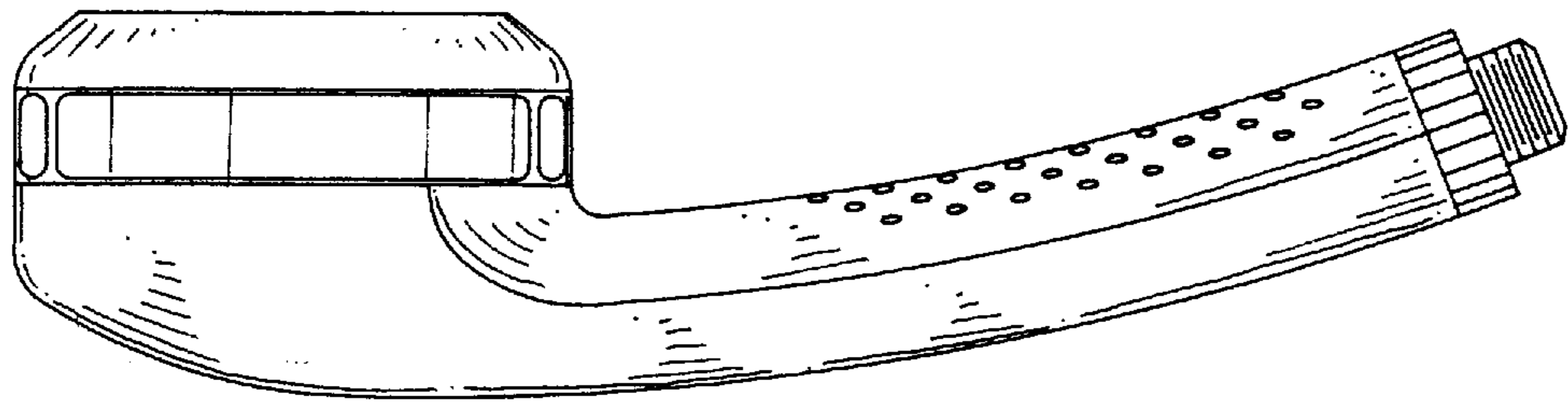

FIG. 3

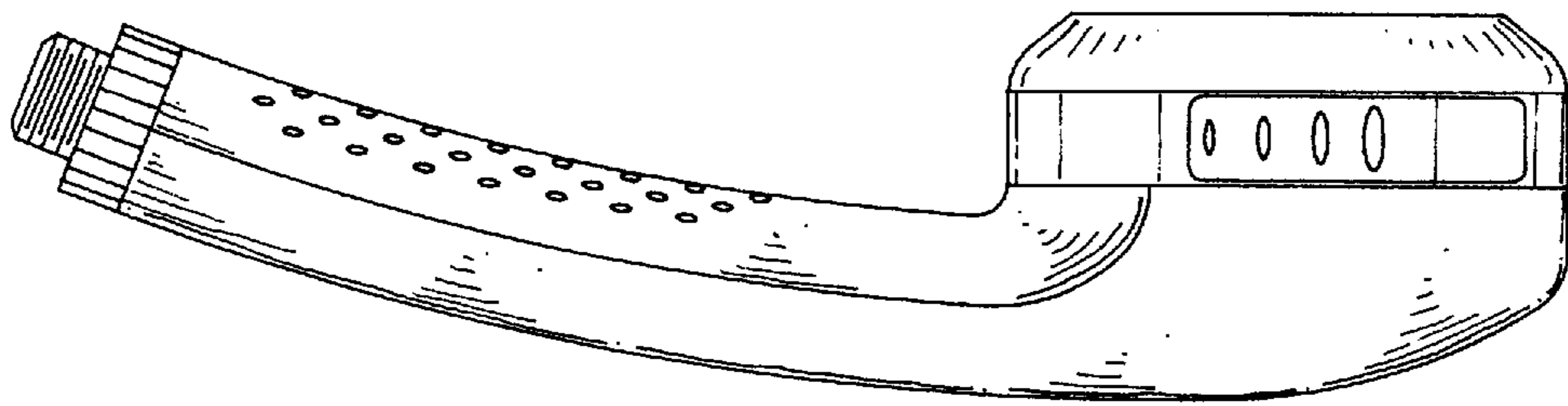

FIG. 4

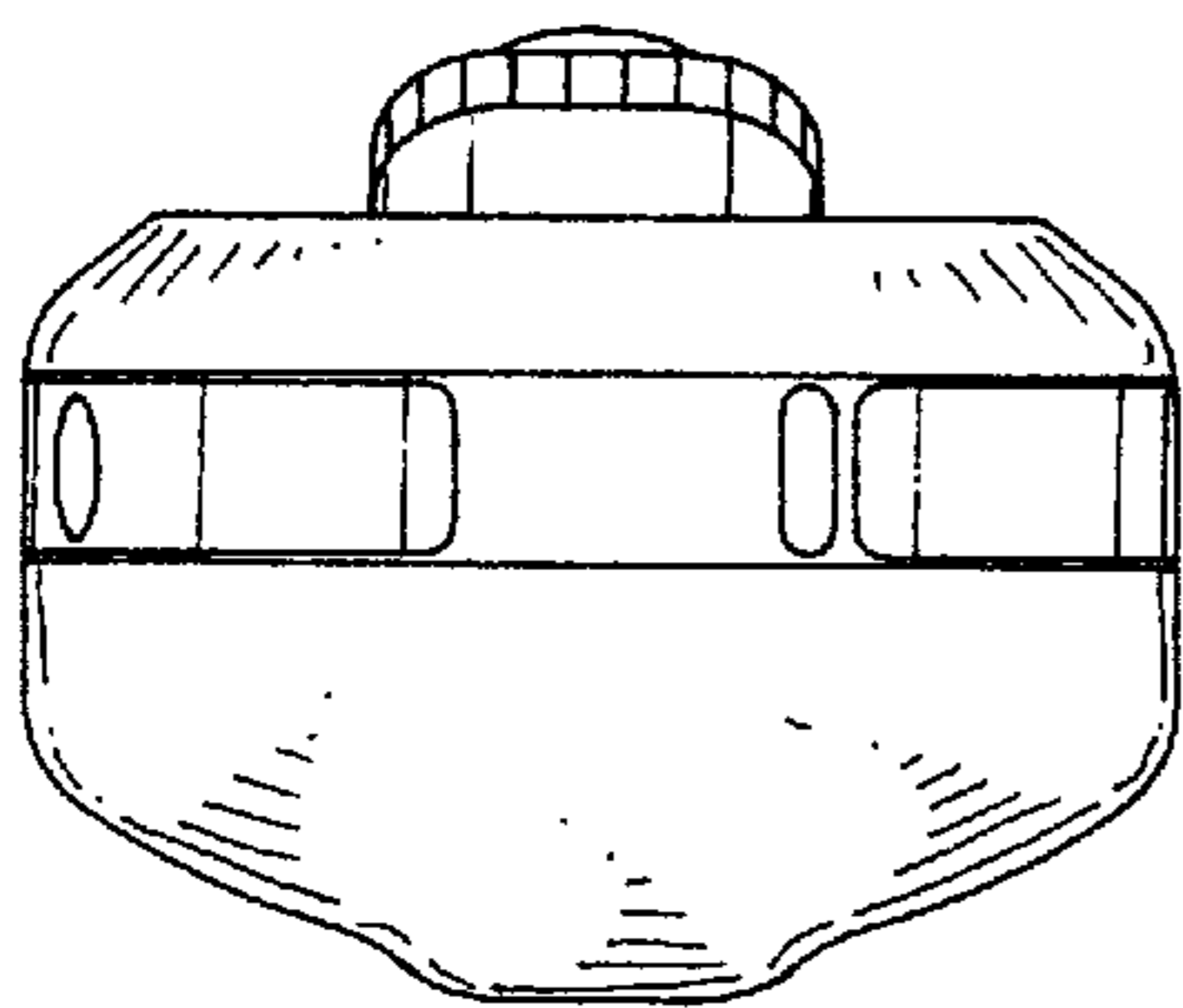

FIG. 5

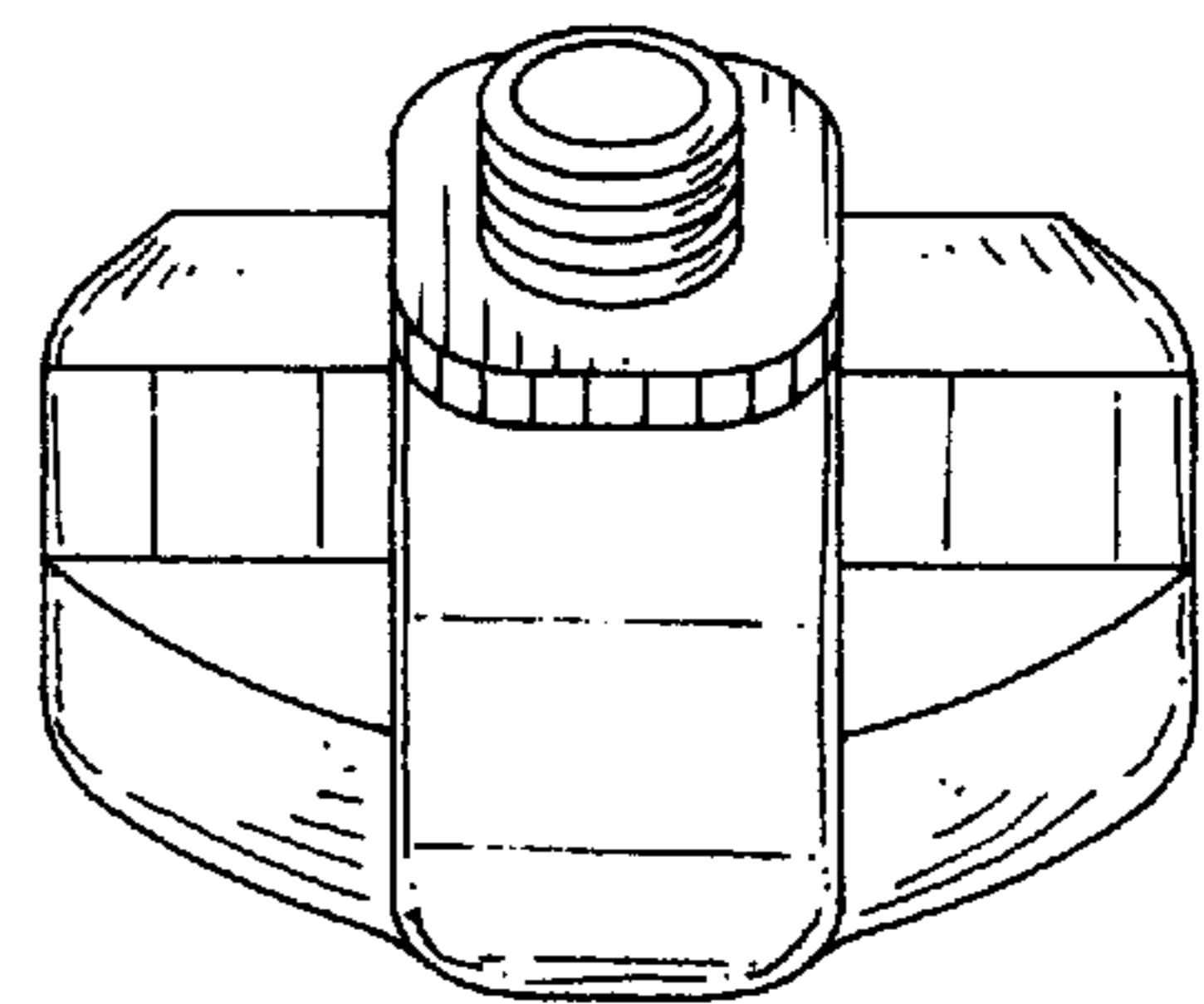

FIG. 6

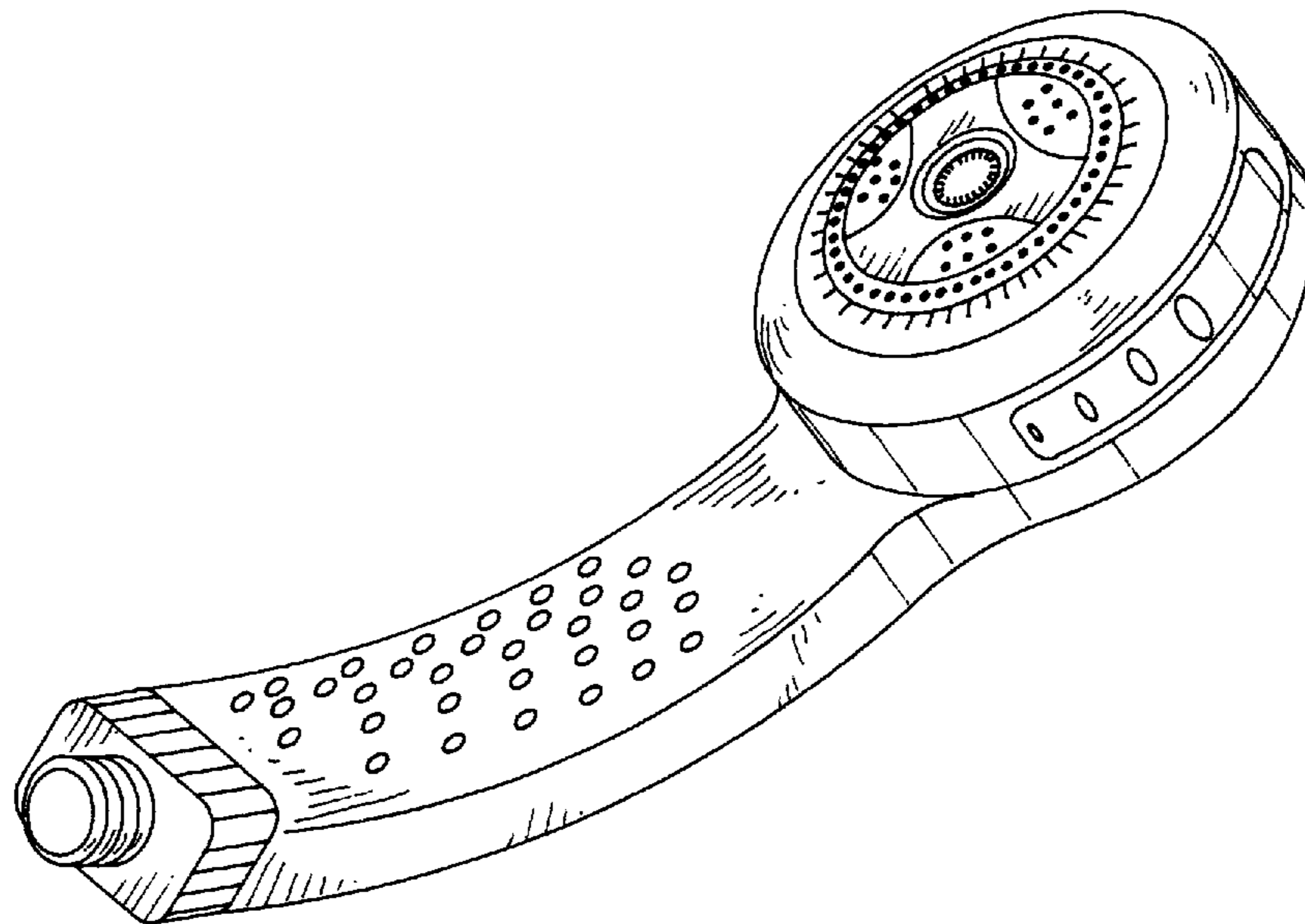

FIG. 7