



US00D399842S

United States Patent [19]

Matsuda et al.

[11] **Patent Number: Des. 399,842**

[45] **Date of Patent: **Oct. 20, 1998**

[54] **SPEAKER PHONE**

[75] Inventors: **Hari Matsuda**, Evantson, Ill.; **Rick T. Mason**, Westland, Mich.; **Frank J. Annerino**, Rolling Meadows, Ill.

[73] Assignee: **3Com Corporation**, Santa Clara, Calif.

[**] Term: **14 Years**

[21] Appl. No.: **78,333**

[22] Filed: **Oct. 21, 1997**

[51] **LOC (6) Cl.** **14-03**

[52] **U.S. Cl.** **D14/150; D14/243**

[58] **Field of Search** D14/137, 138, D14/148, 149-151, 240, 243, 140-142; 379/433-436, 419, 420, 428, 440, 338-390, 406, 410; D21/48

[56] **References Cited**

U.S. PATENT DOCUMENTS

D. 304,335	10/1989	Chen	D14/142
D. 307,274	4/1990	Sasaki et al.	D14/243
D. 342,732	12/1993	Hinman et al.	D14/150
D. 346,598	5/1994	McCan et al.	D14/137
D. 355,416	2/1995	McCan et al.	D14/137
D. 373,585	9/1996	Nagele et al.	D14/149
D. 382,265	8/1997	Bradley et al.	D14/149

D. 382,266	8/1997	Wakefield	D14/150
5,664,015	9/1997	Ford et al.	379/420 X

OTHER PUBLICATIONS

Hello Direct on line, Siemens/Rolm PBX, www.hello-direct.com Feb. 1998.

Primary Examiner—Jeffrey Asch
Attorney, Agent, or Firm—McDonnell Boehnen Hulbert & Berghoff

[57] **CLAIM**

The ornamental design for a speaker phone, as shown and described.

DESCRIPTION

FIG. 1 is a perspective view of the speaker phone; FIG. 2 is a top plan view of the speaker phone; FIG. 3 is a bottom plan view of the speaker phone; FIG. 4 is a front elevational view of the speaker phone; FIG. 5 is a rear elevational view of the speaker phone; FIG. 6 is a side elevational view of the speaker phone, as seen from the right hand side of the machine; FIG. 7 is a side elevational view of the speakerphone, as seen from the left hand side of the machine. The broken line showings throughout the views are for illustrative purposes only and form no part of the claimed design;

1 Claim, 3 Drawing Sheets

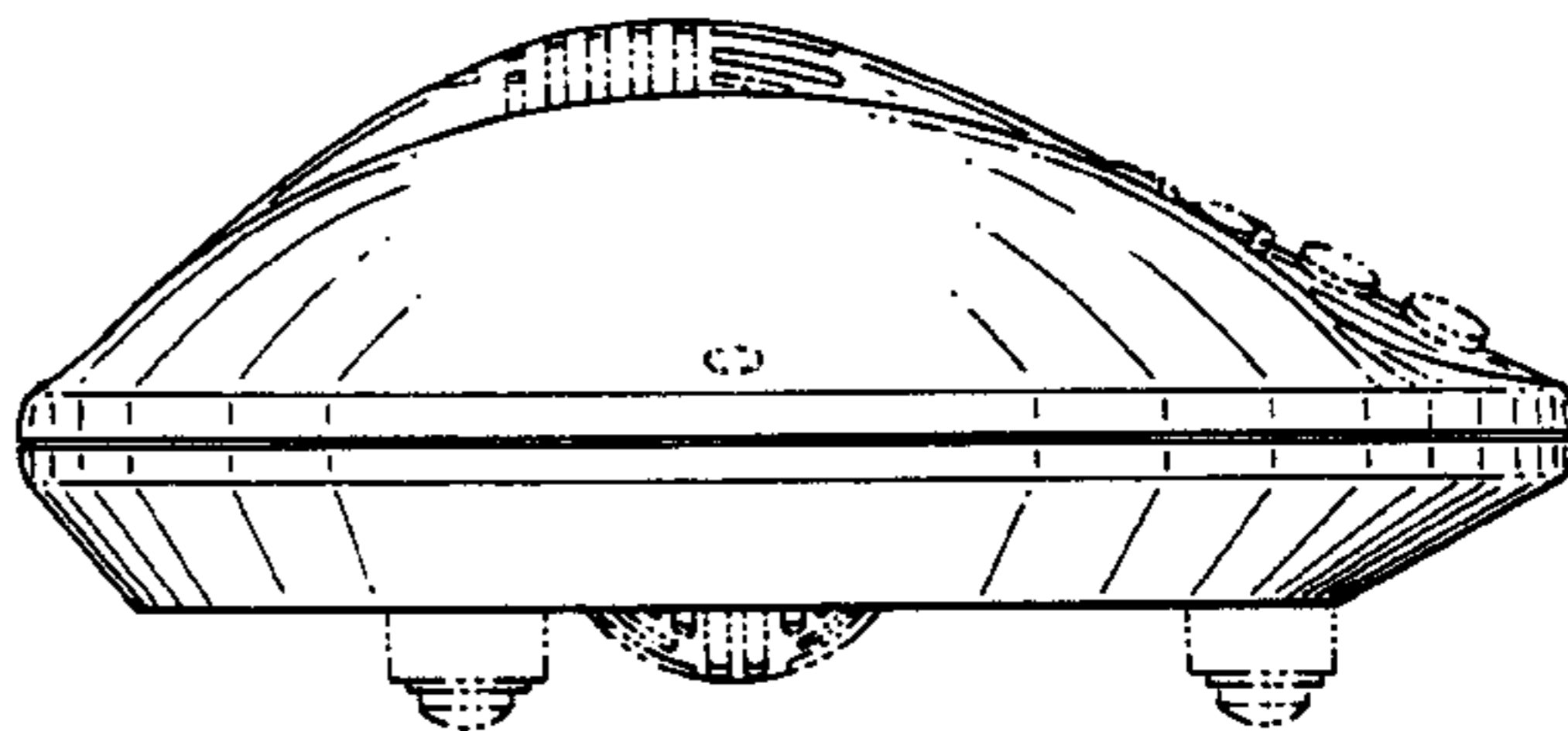
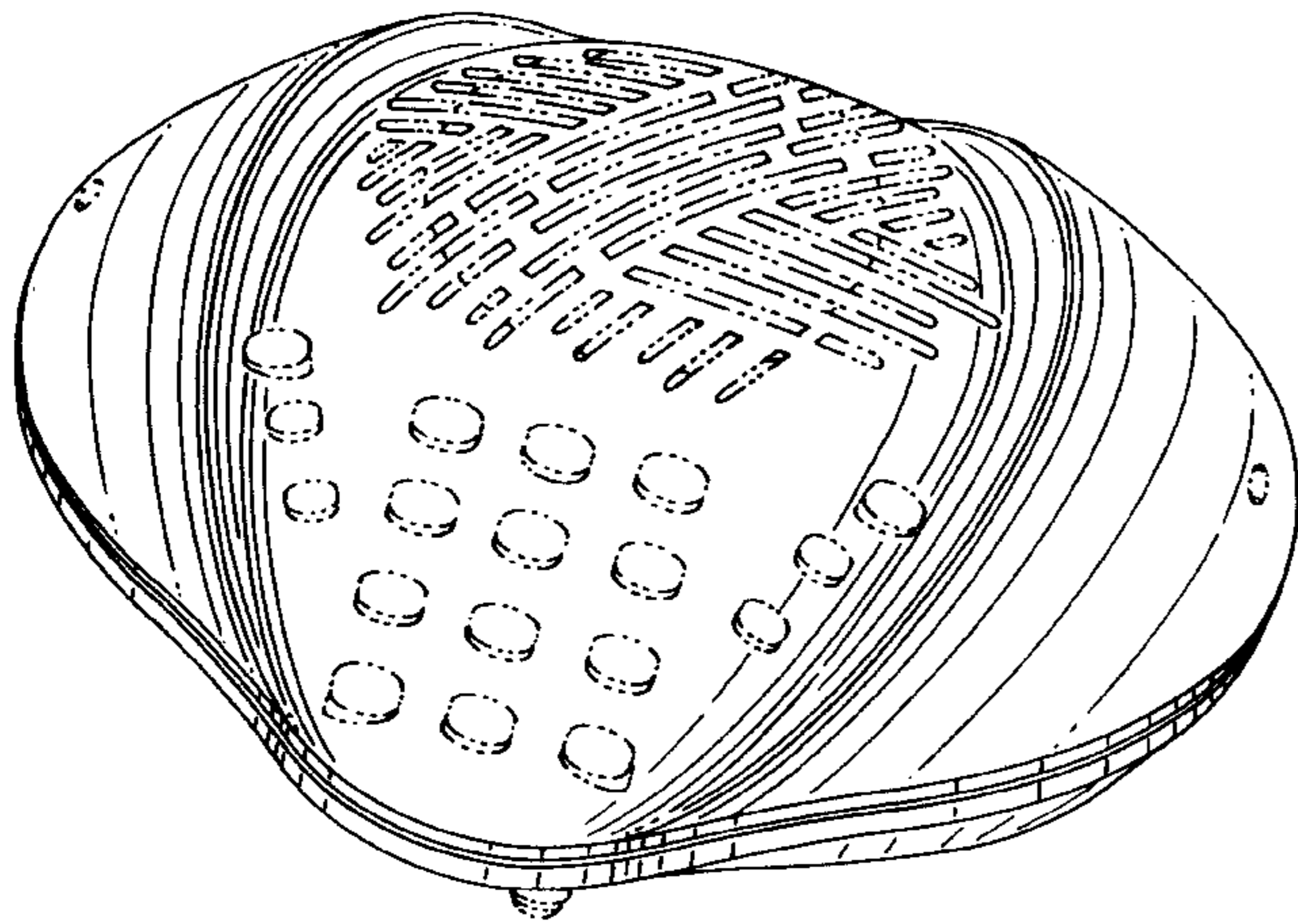

FIG. 1

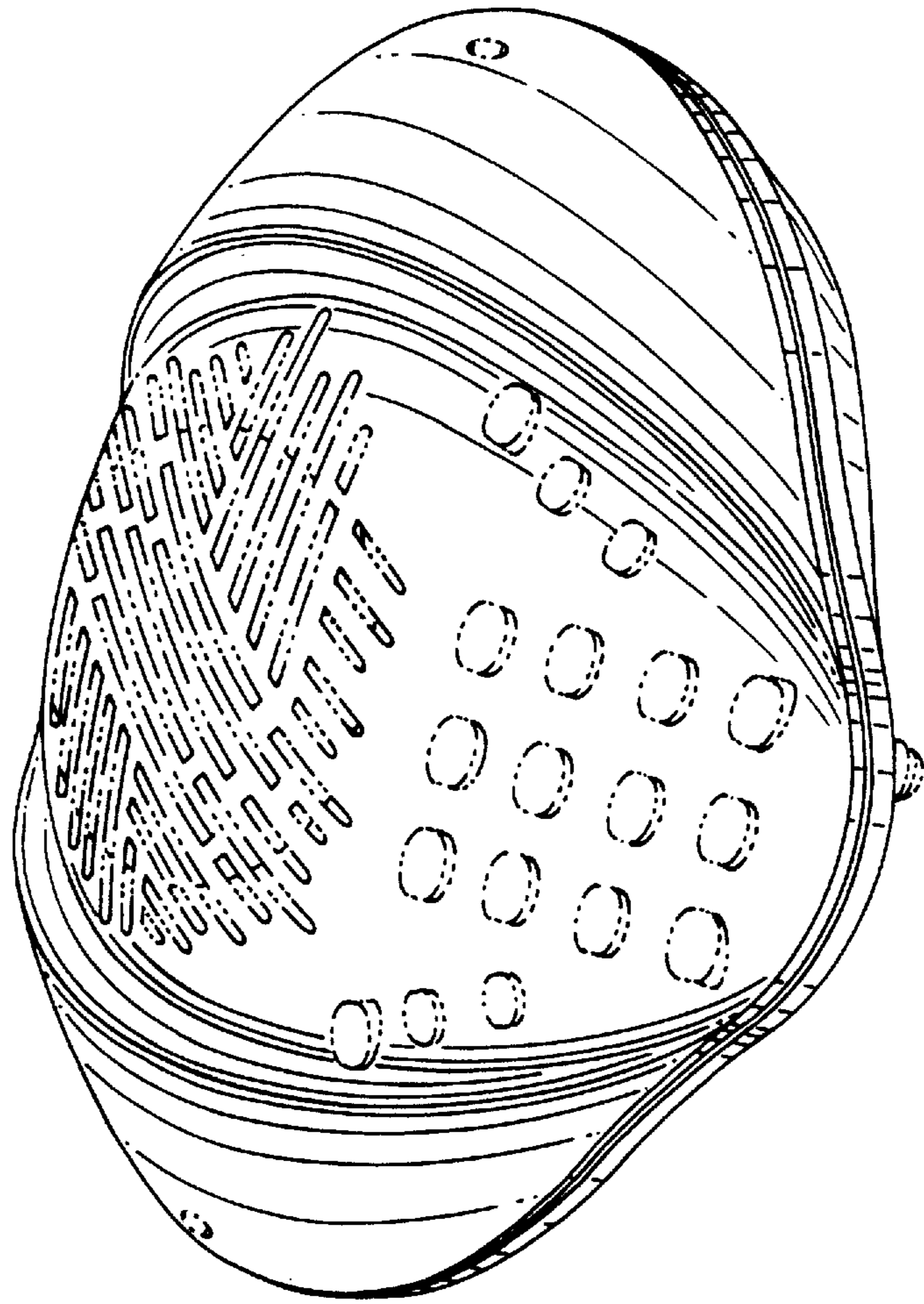

FIG. 2

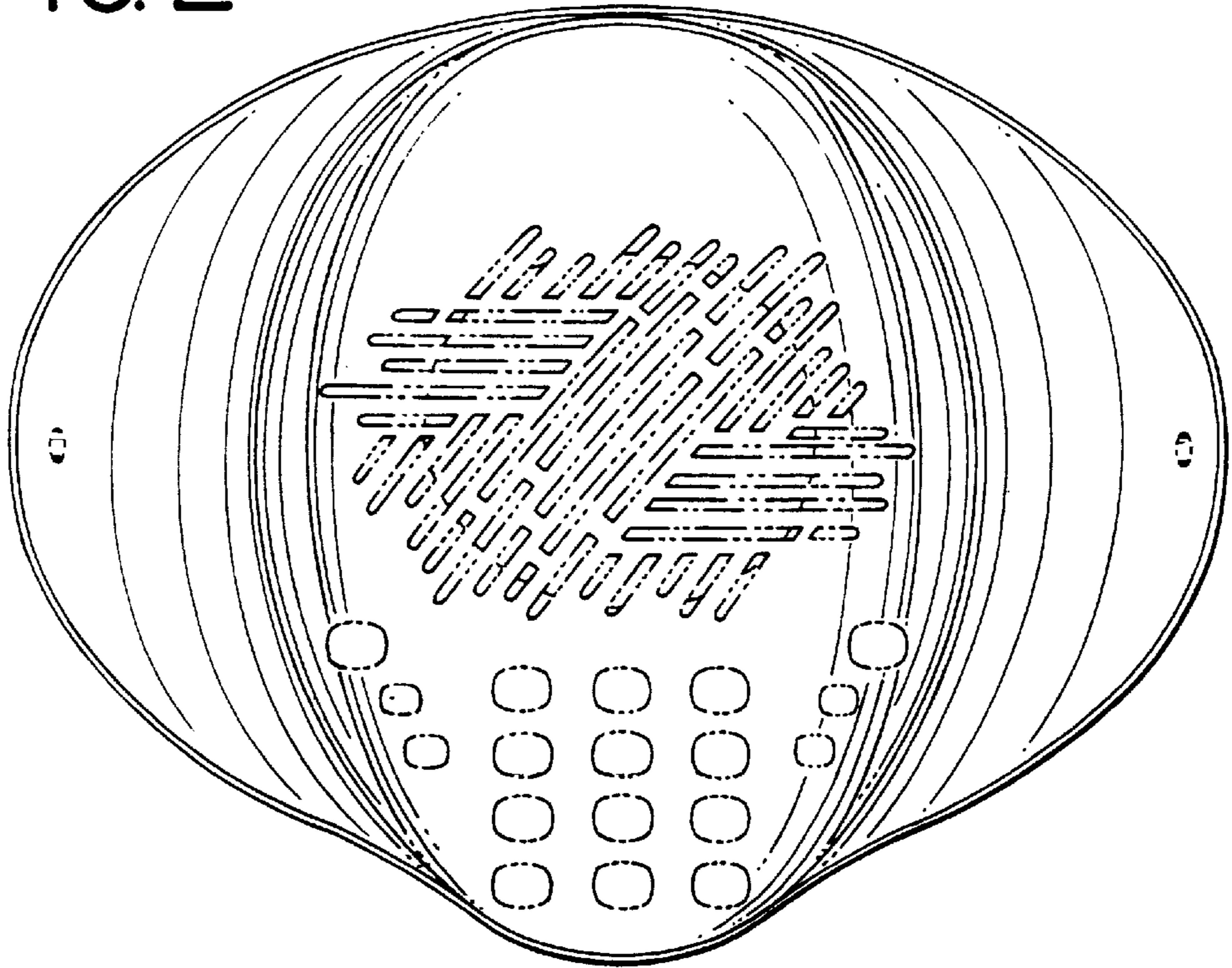

FIG. 3

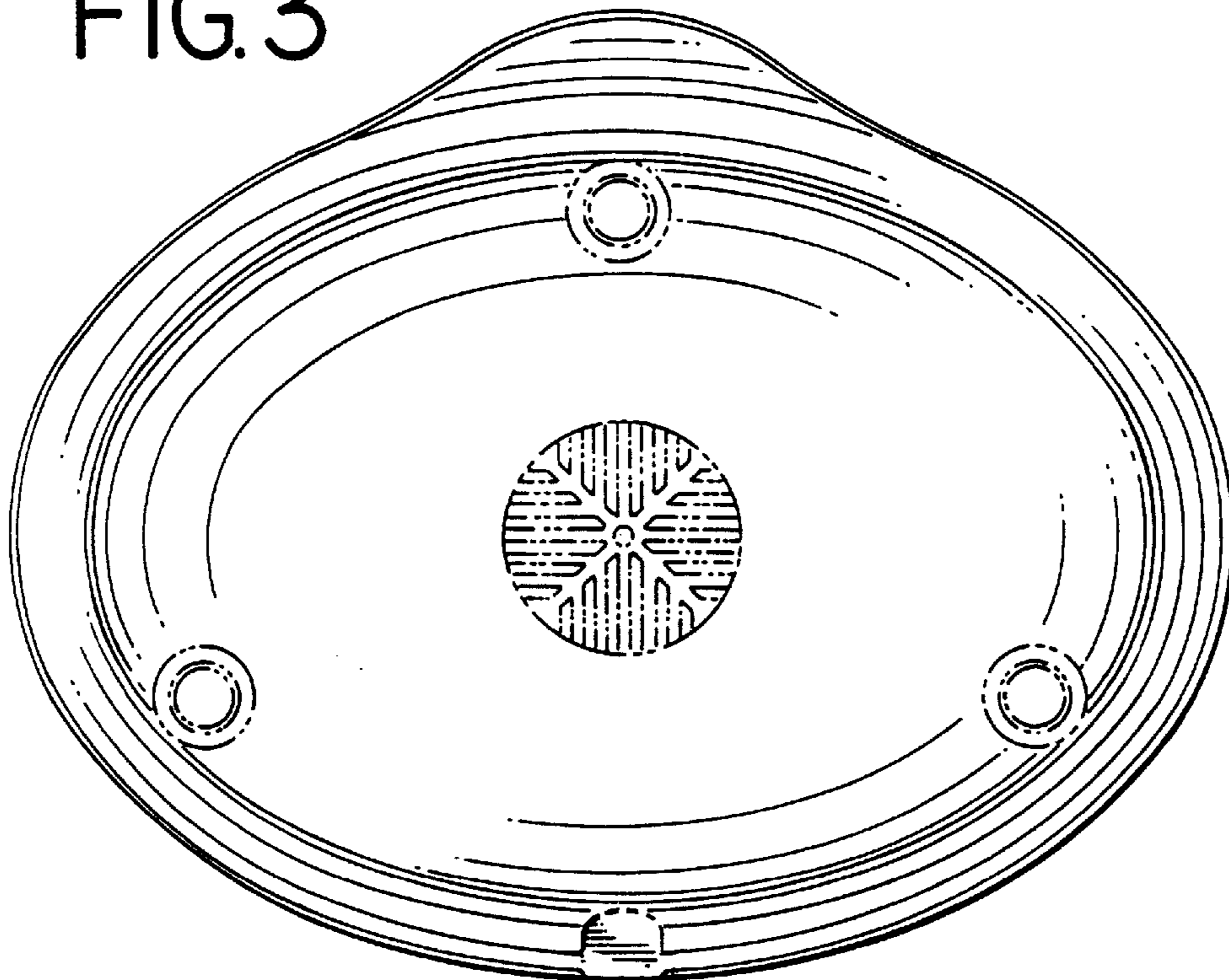

FIG. 4

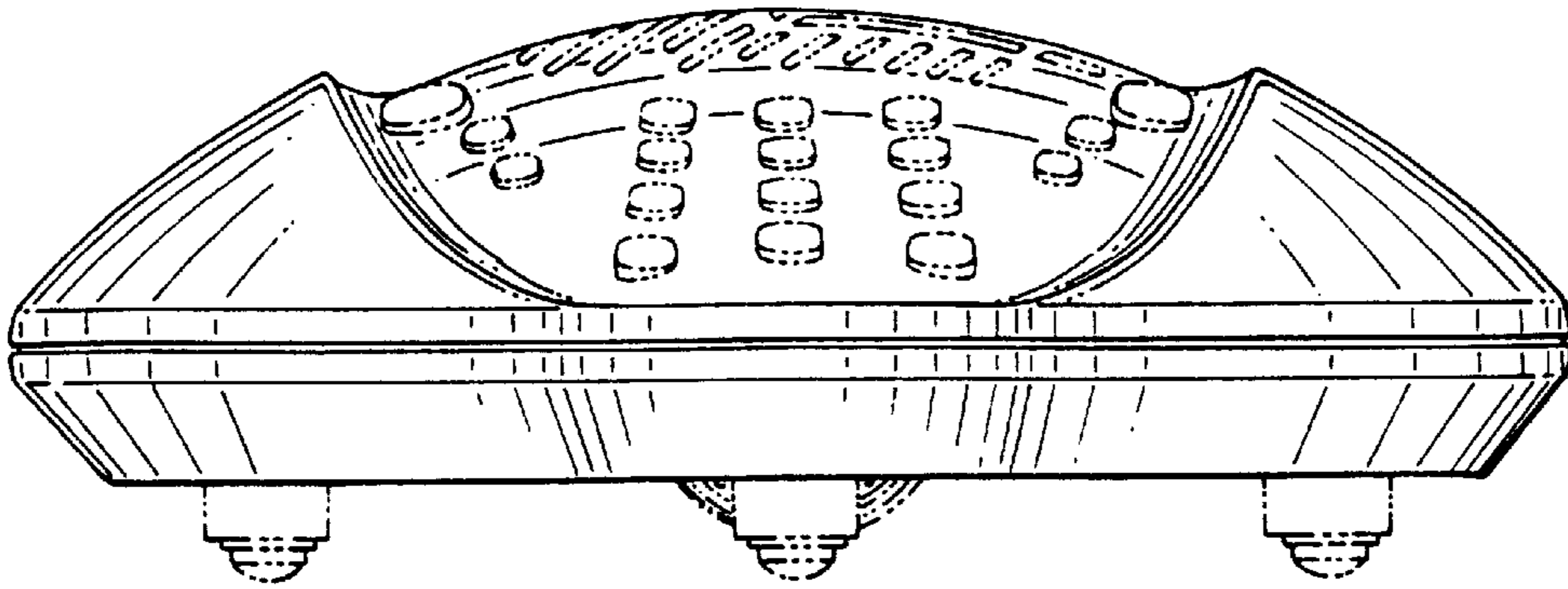

FIG. 5

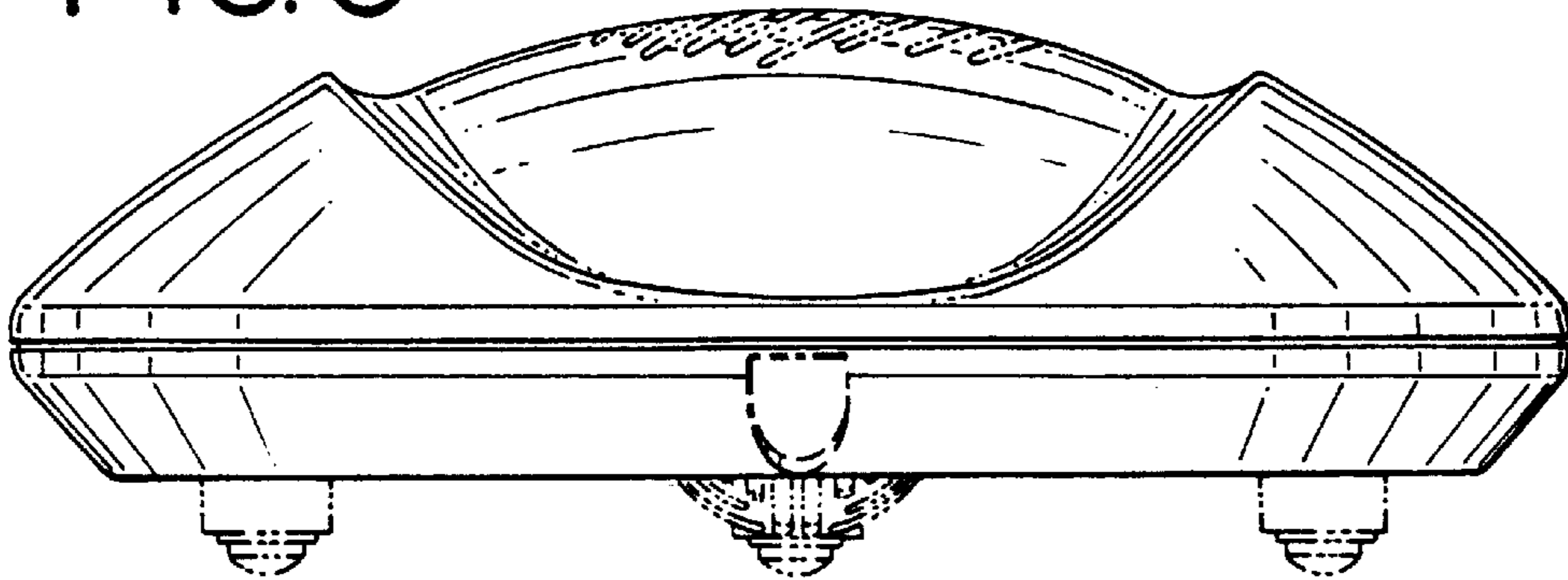

FIG. 6

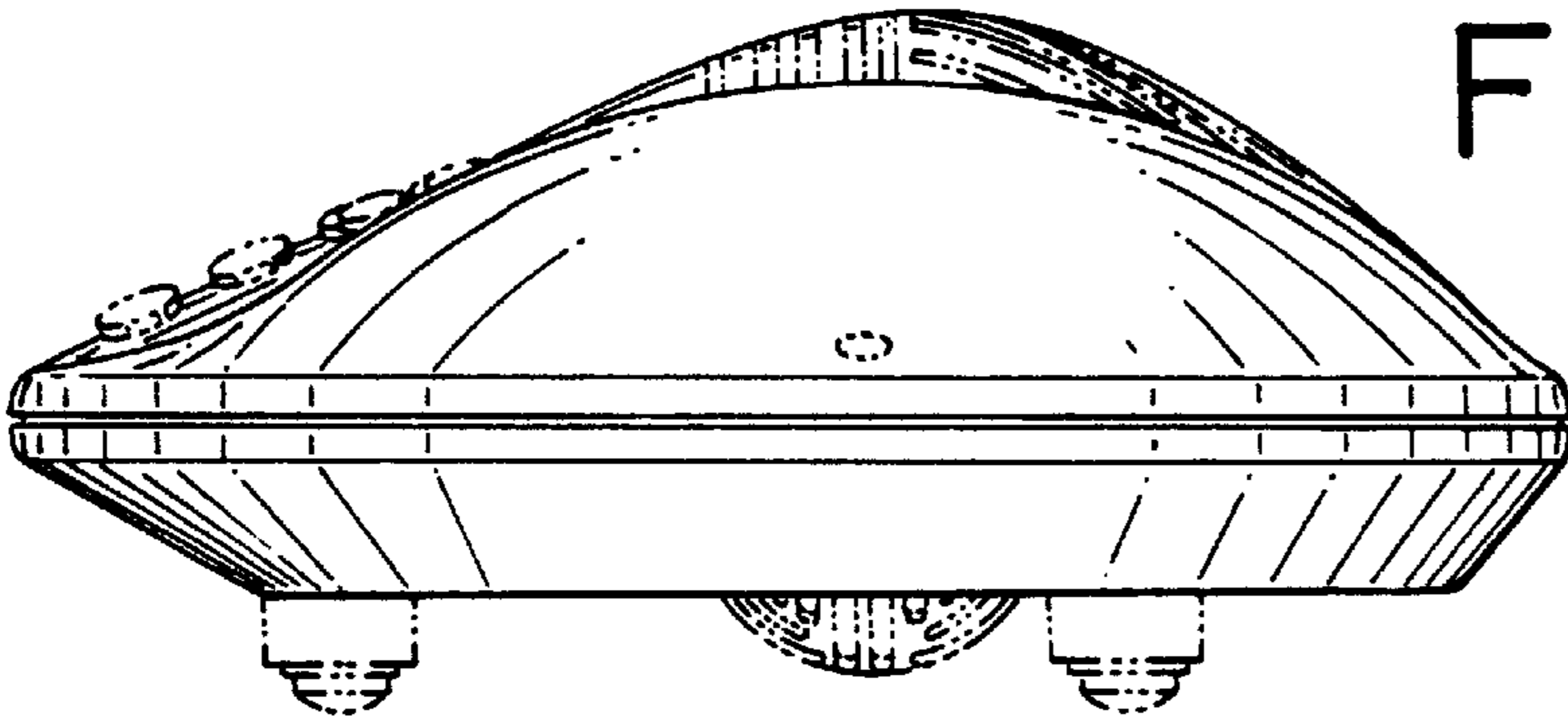

FIG. 7

