



US00D399784S

United States Patent [19]

Weder et al.

[11] Patent Number: Des. 399,784

[45] Date of Patent: **Oct. 20, 1998

[54] FLOWER POT COVER

[75] Inventors: Donald E. Weder; Joseph G. Straeter, both of Highland, Ill.

[73] Assignee: Southpac Trust International, Inc.

[**] Term: 14 Years

[21] Appl. No.: 65,328

[22] Filed: Jan. 21, 1997

D. 368,876	4/1996	Weder et al.	D11/164
D. 368,877	4/1996	Weder et al.	D11/164
D. 380,414	7/1997	Weder et al.	D11/164
D. 385,217	10/1997	Weder et al.	D11/164
1,520,647	12/1924	Hennegan	47/72
1,794,212	2/1931	Snyder	47/72
1,951,642	3/1934	Augustin et al.	47/34
2,355,559	8/1944	Renner	229/8
2,827,217	3/1958	Clement	229/1.5
3,443,741	5/1969	Stockdale	229/51
4,043,077	8/1977	Stonehocker	47/66
4,712,725	12/1987	Moore	229/8
5,076,011	12/1991	Stehouwer	47/72

Related U.S. Application Data

[62] Division of Ser. No. 46,635, Oct. 18, 1995, Pat. No. Des. 380,414, which is a division of Ser. No. 7,760, Apr. 30, 1993, Pat. No. Des. 363,899, which is a continuation-in-part of Ser. No. 782,237, Oct. 18, 1991, Pat. No. Des. 349,076, which is a continuation-in-part of Ser. No. 617,454, Nov. 21, 1990, abandoned, and Ser. No. 411,249, Sep. 22, 1989, Pat. No. Des. 358,113, and Ser. No. 411,247, Sep. 22, 1989, abandoned, and a continuation-in-part of Ser. No. 411,245, Sep. 22, 1989, abandoned.

[51] LOC (6) Cl. 11-02

[52] U.S. Cl. D11/164

[58] Field of Search D11/143, 149, D11/152-156, 164, 89, 90; 47/66, 72; 206/423; 215/100.5; 229/1.5 R, 1.5 B, 4.5, 108, 108.1, 109, 110, 87.01, 922, 930, 186, 189; 428/27, 35.1, 24, 542.6; 338/122; D9/346, 428-431; D27/102, 133; D26/128-136; D19/96; D7/540, 584, 586, 587, 354

[56] References Cited

U.S. PATENT DOCUMENTS

D. 239,192	3/1976	Wiles et al.	D35/3 A
D. 254,659	4/1980	Karotseris	D11/143
D. 292,182	10/1987	Weder et al.	D11/164
D. 292,562	11/1987	Weder et al.	D11/164
D. 293,224	12/1987	Weder et al.	D11/164
D. 293,775	1/1988	Weder et al.	D11/164
D. 317,583	6/1991	Weder et al.	D11/164
D. 322,403	12/1991	Eaton	D9/429
D. 324,659	3/1992	Stehouwer	D11/164
D. 349,076	7/1994	Weder et al.	D11/164
D. 363,899	11/1995	Weder et al.	D11/164
D. 364,119	11/1995	Weder et al.	D11/164

FOREIGN PATENT DOCUMENTS

785369	8/1935	France	229/186
2489126	3/1982	France	.	
2603159	4/1988	France	.	
153402	of 1903	Germany	47/72
1115	of 1887	Sweden	47/72
17903	5/1899	Switzerland	47/72
54263	7/1912	Switzerland	47/72

OTHER PUBLICATIONS

The Glassware of Frederick Carder, p. 327, item 1267, 1971. "The Simple Solution For Those Peak Volume Periods", (4 pages) a brochure published by Highland Supply Corporation, 1111 Sixth St., Highland, Illinois 62249 ©1989.

Primary Examiner—Jeffrey Asch
Attorney, Agent, or Firm—Dunlap & Coddling, P.C.

[57] CLAIM

The ornamental design for a flower pot cover, as shown and described.

DESCRIPTION

FIG. 1 is a perspective view of our new flower pot cover design;
FIG. 2 is a side elevational view thereof;
FIG. 3 is a top plan view thereof;
FIG. 4 is a bottom plan view thereof;
FIG. 5 is a perspective view of a second embodiment of our new flower pot cover design;
FIG. 6 is a side elevational view thereof;
FIG. 7 is a top plan view thereof;
FIG. 8 is a bottom plan view thereof;

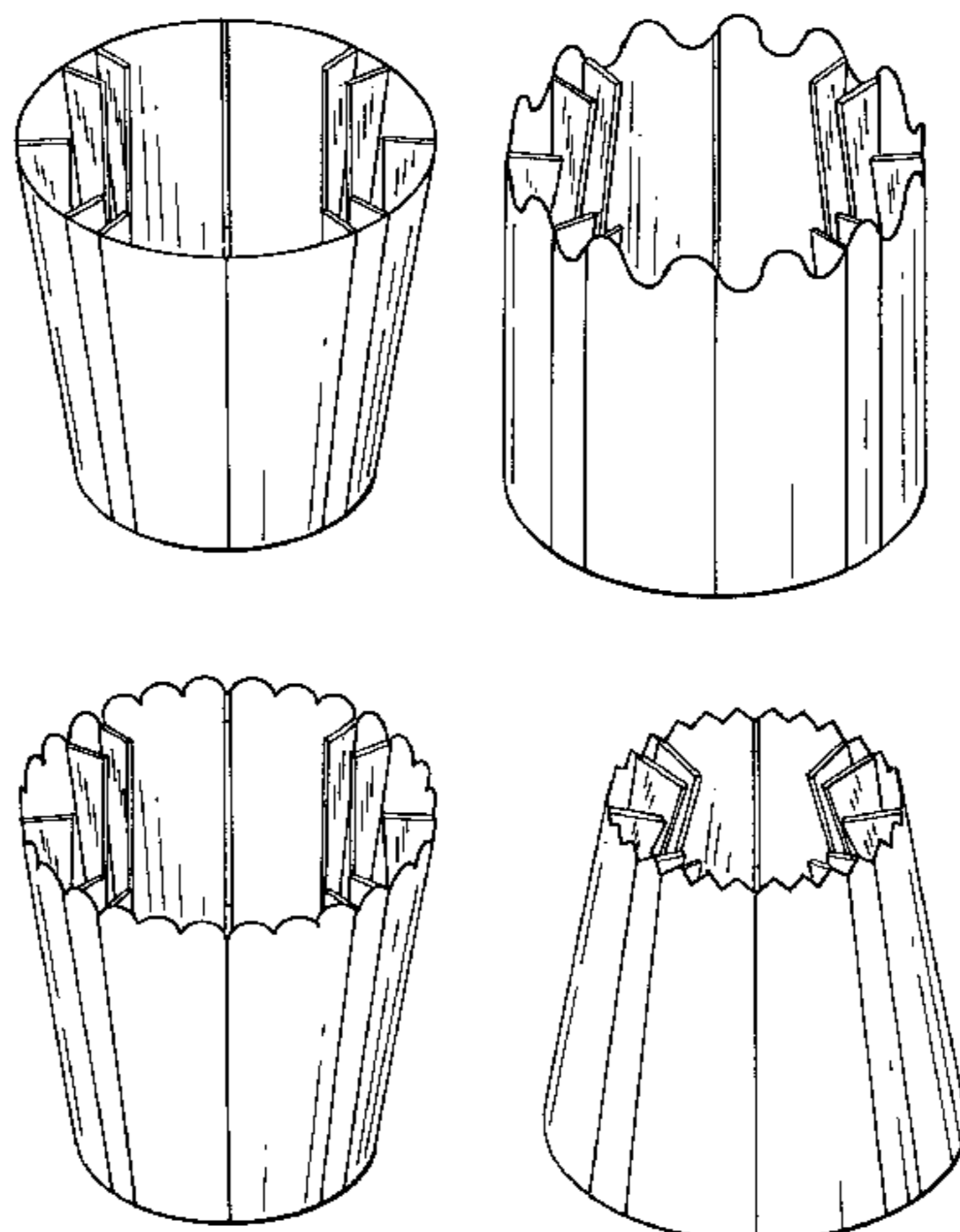

FIG. 9 is a perspective view of a third embodiment of our new flower pot cover design;
FIG. 10 is a side elevational view thereof;
FIG. 11 is a top plan view thereof;
FIG. 12 is a bottom plan view thereof;
FIG. 13 is a perspective view of a fourth embodiment of our new flower pot cover design;
FIG. 14 is a side elevational view thereof;
FIG. 15 is a top plan view thereof;
FIG. 16 is a bottom plan view thereof;
FIG. 17 is a perspective view of a fifth embodiment of our new flower pot cover design;
FIG. 18 is a side elevational view thereof;
FIG. 19 is a top plan view thereof;
FIG. 20 is a bottom plan view thereof;
FIG. 21 is a perspective view of a sixth embodiment of our new flower pot cover design;
FIG. 22 is a side elevational view thereof;
FIG. 23 is a top plan view thereof;
FIG. 24 is a bottom plan view thereof;
FIG. 25 is a perspective view of a seventh embodiment of our new flower pot cover design;
FIG. 26 is a side elevational view thereof;
FIG. 27 is a top plan view thereof;
FIG. 28 is a bottom plan view thereof;
FIG. 29 is a perspective view of an eighth embodiment of our new flower pot cover design;

FIG. 30 is a side elevational view thereof;
FIG. 31 is a top plan view thereof;
FIG. 32 is a bottom plan view thereof;
FIG. 33 is a perspective view of a ninth embodiment of our new flower pot cover design;
FIG. 34 is a side elevational view thereof;
FIG. 35 is a top plan view thereof;
FIG. 36 is a bottom plan view thereof;
FIG. 37 is a perspective view of a tenth embodiment of our new flower pot cover design;
FIG. 38 is a side elevational view thereof;
FIG. 39 is a top plan view thereof;
FIG. 40 is a bottom plan view thereof;
FIG. 41 is a perspective view of an eleventh embodiment of our new flower pot cover design;
FIG. 42 is a side elevational view thereof;
FIG. 43 is a top plan view thereof;
FIG. 44 is a bottom plan view thereof;
FIG. 45 is a perspective view of a twelfth embodiment of our new flower pot cover design;
FIG. 46 is a side elevational view thereof;
FIG. 47 is a top plan view thereof; and,
FIG. 48 is a bottom plan view thereof.

1 Claim, 12 Drawing Sheets

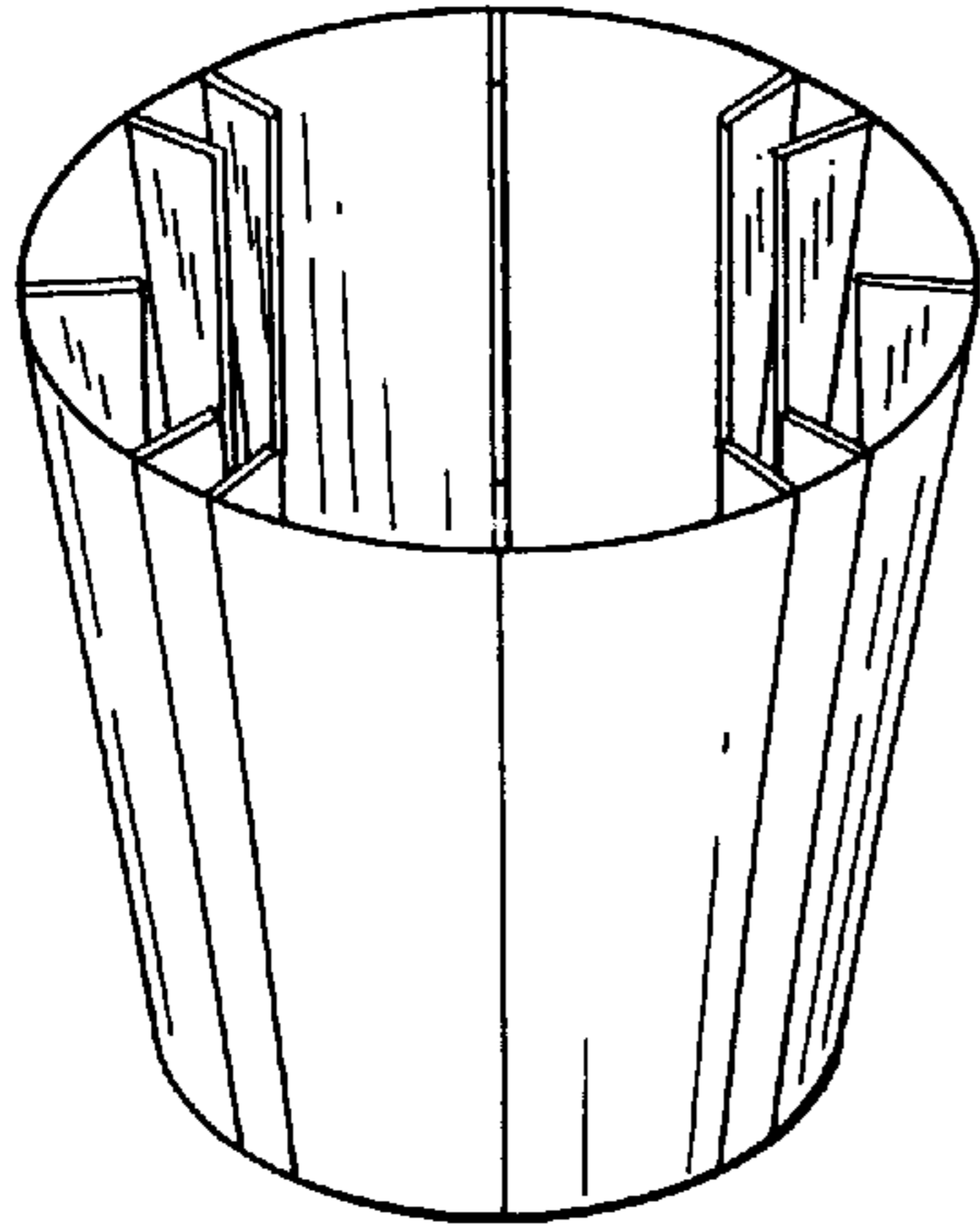

FIG. 1

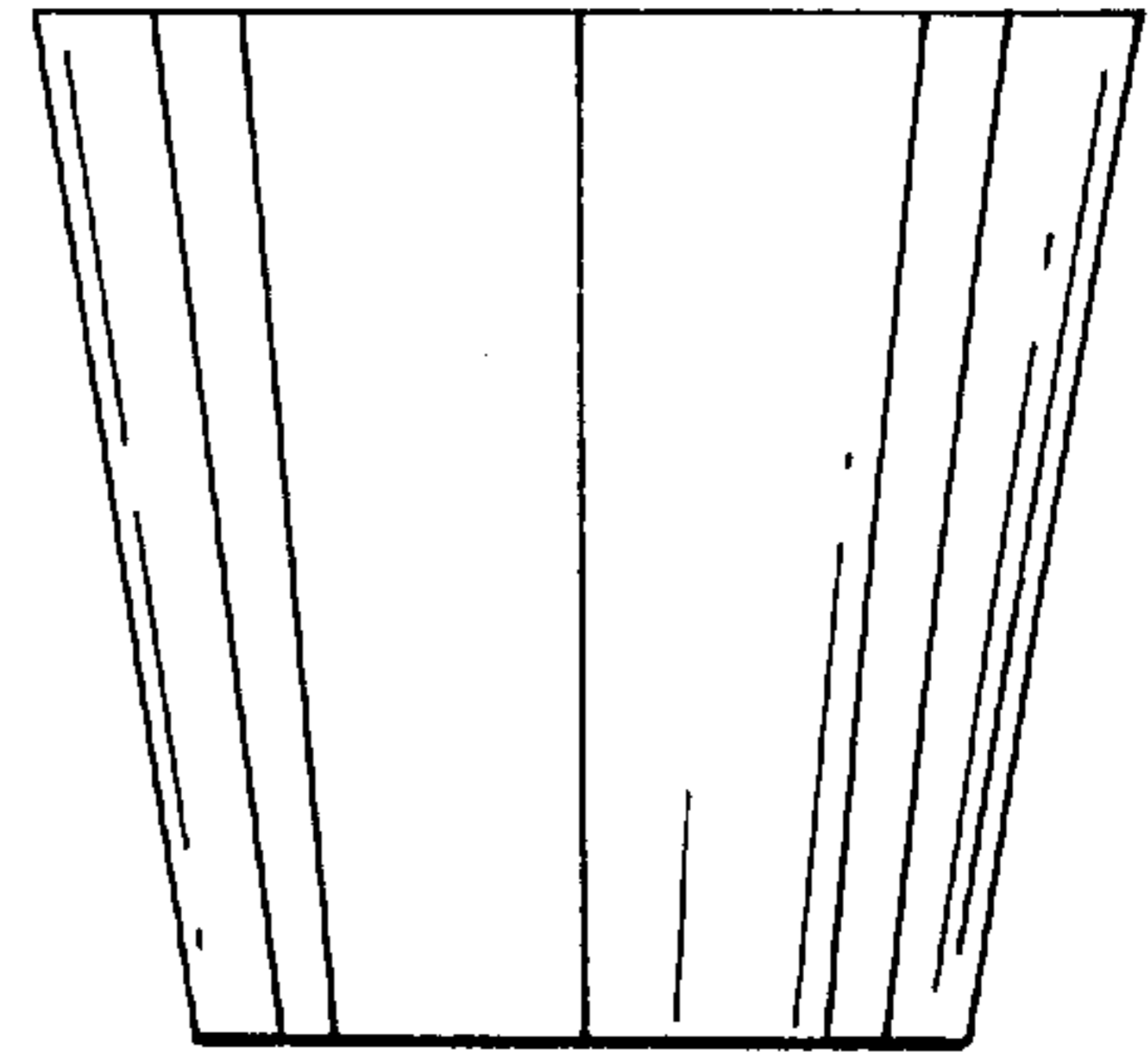

FIG. 2

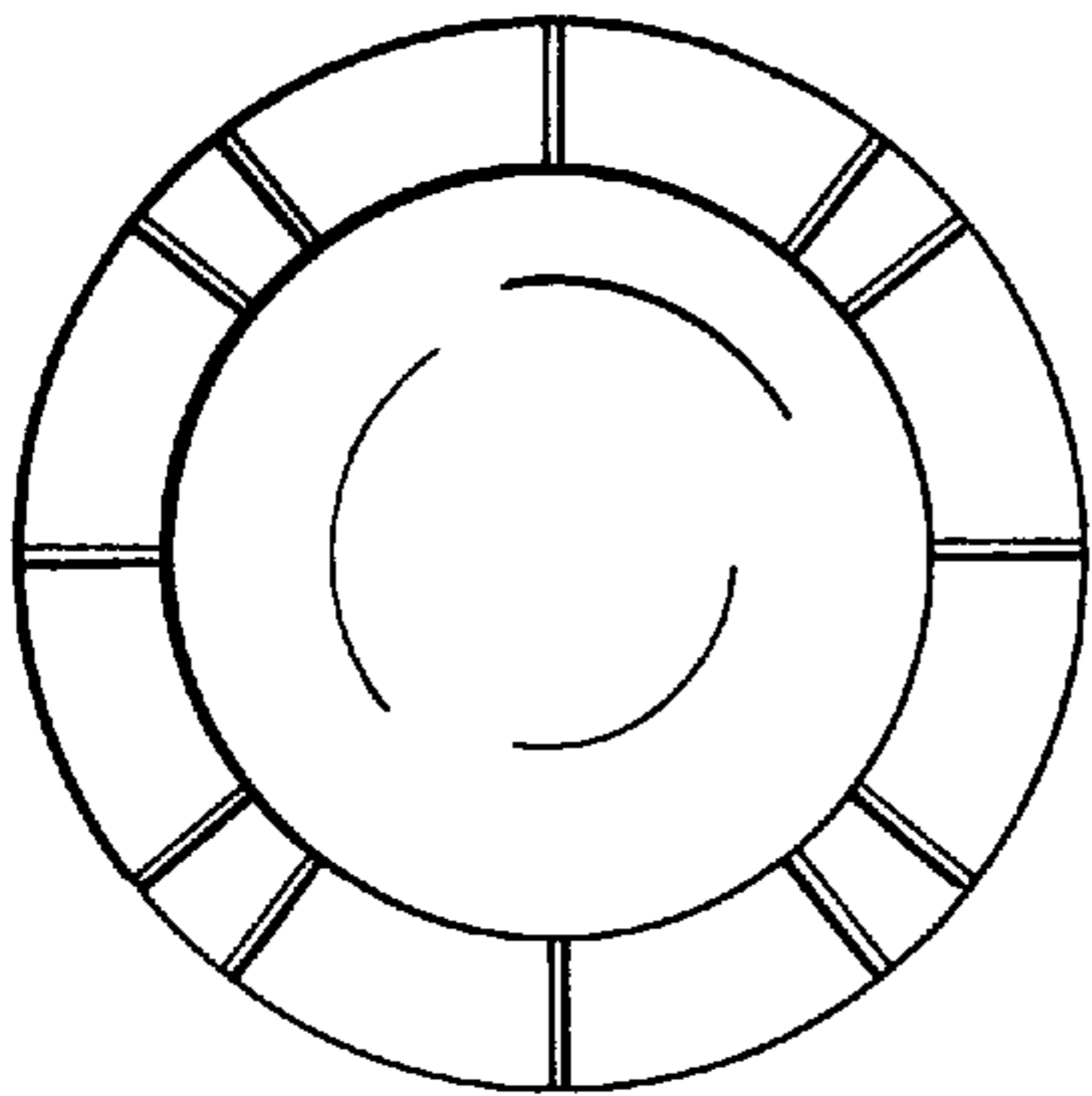

FIG. 3

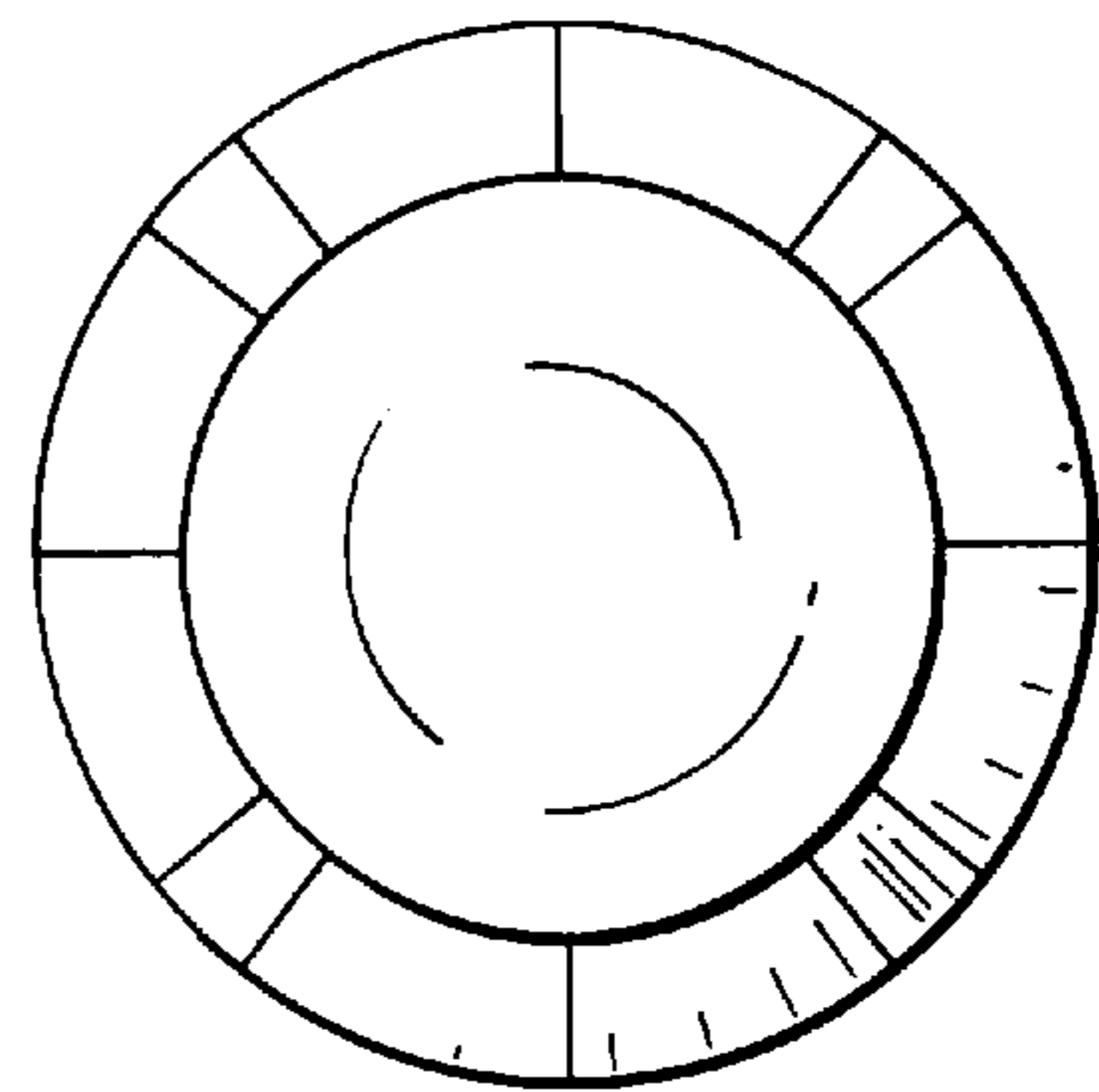

FIG. 4

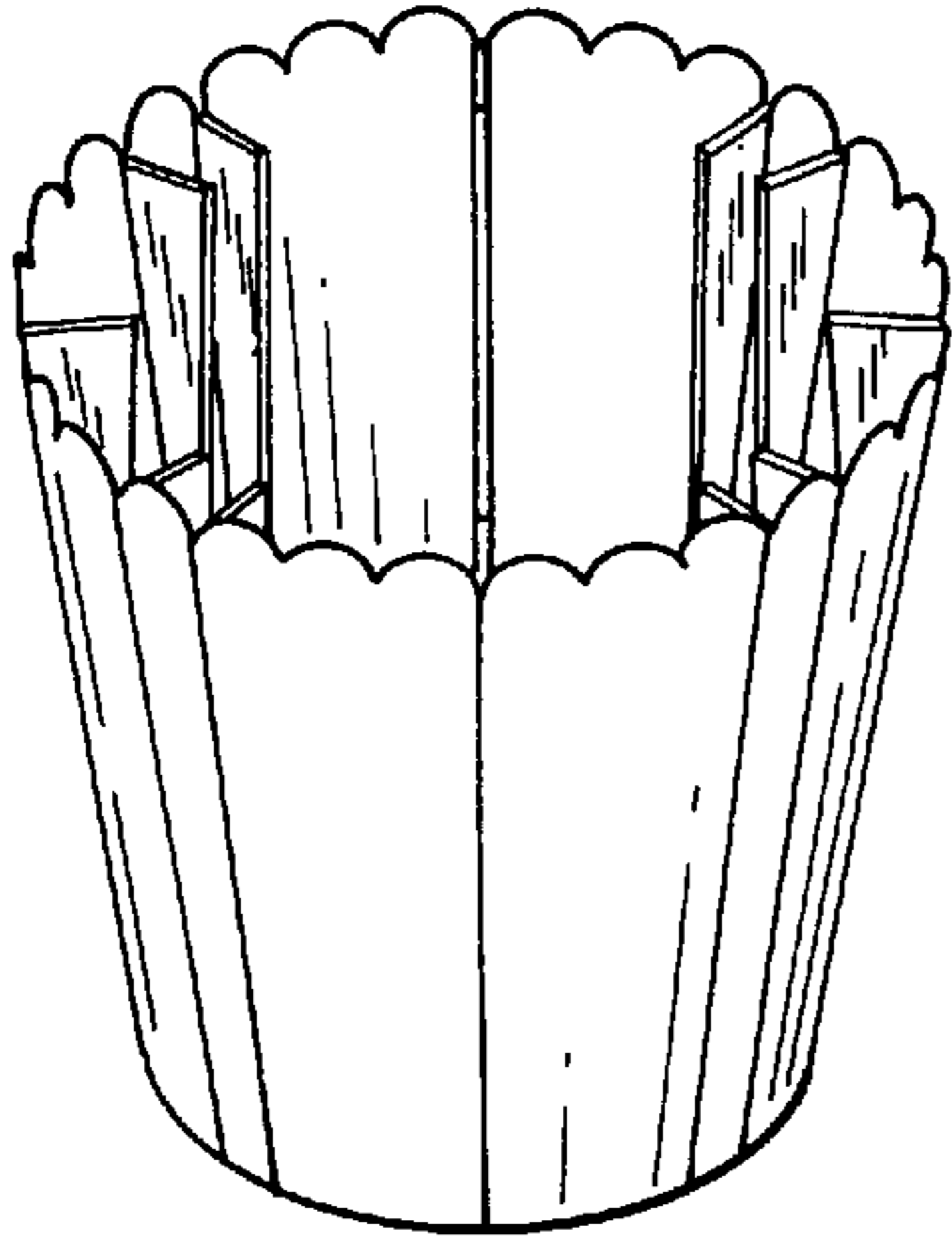

FIG. 5

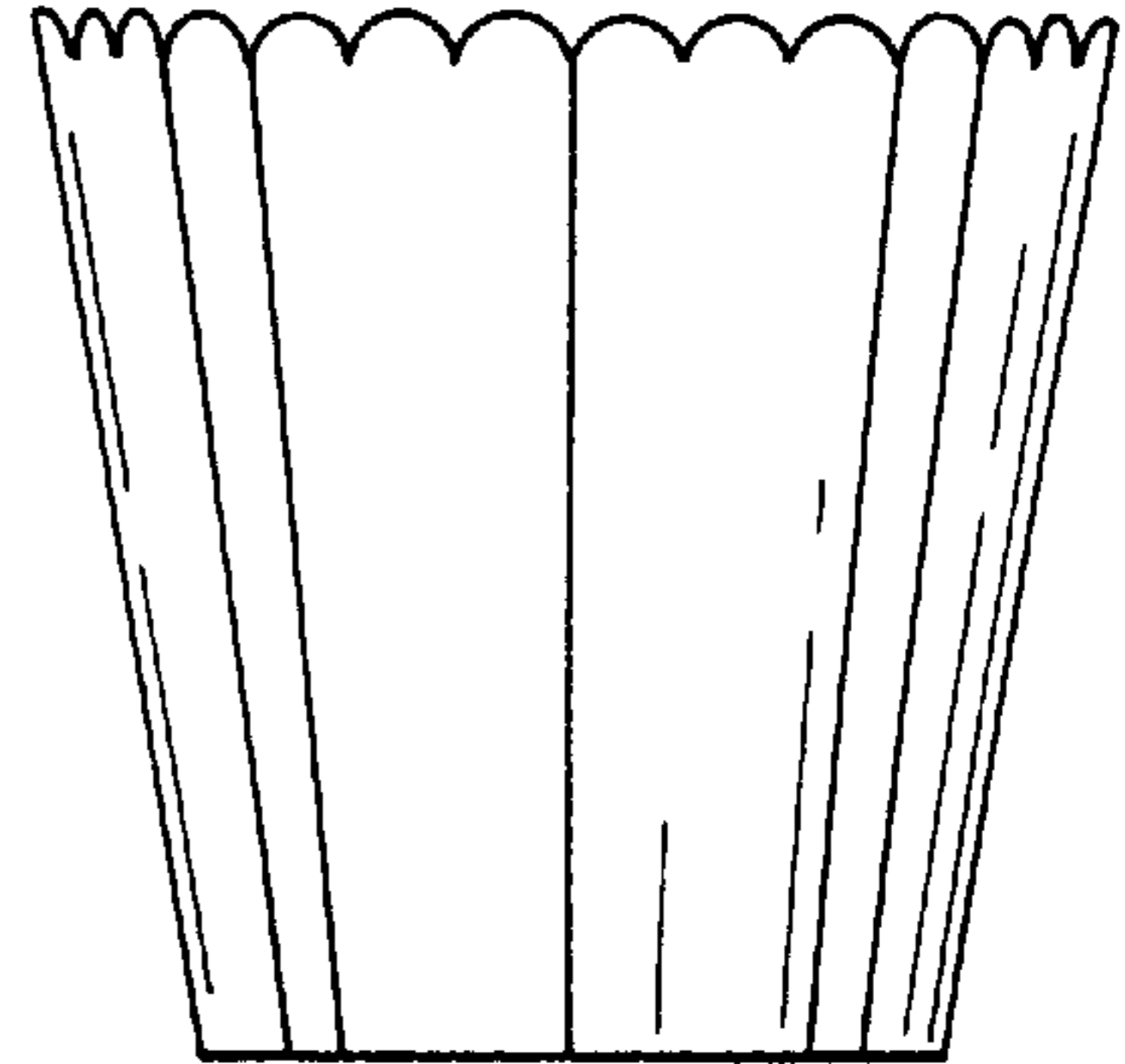

FIG. 6

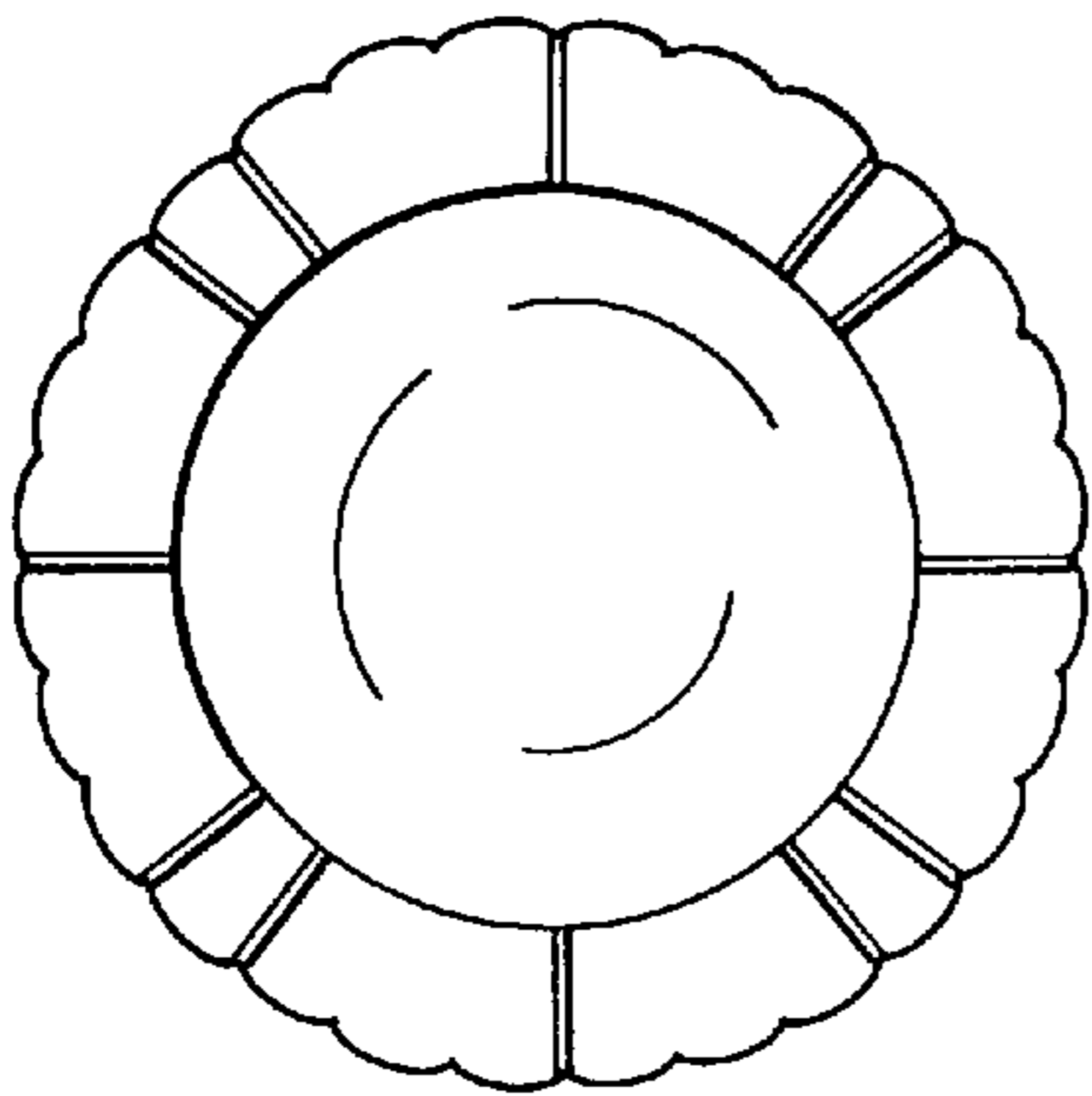

FIG. 7

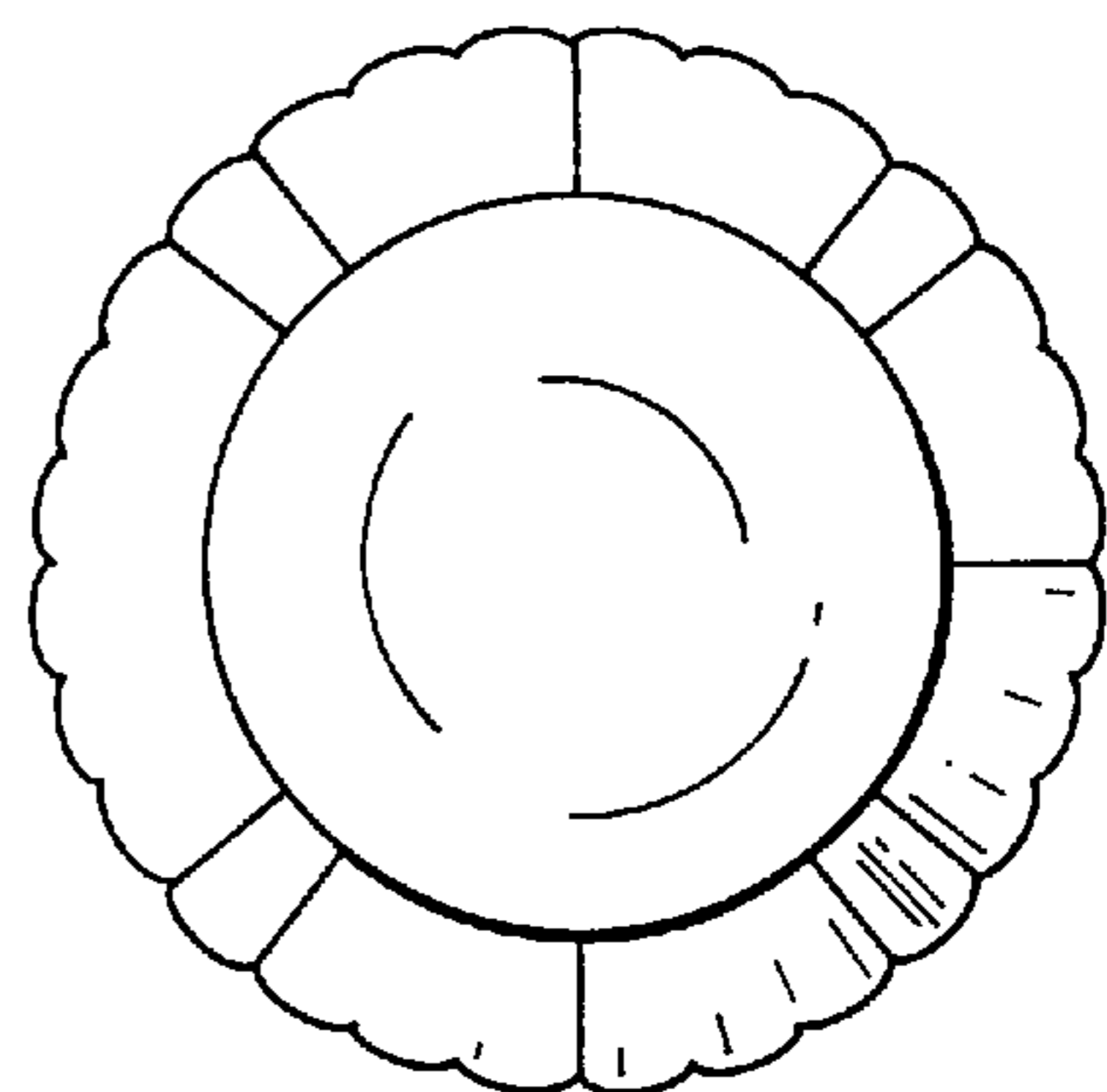

FIG. 8

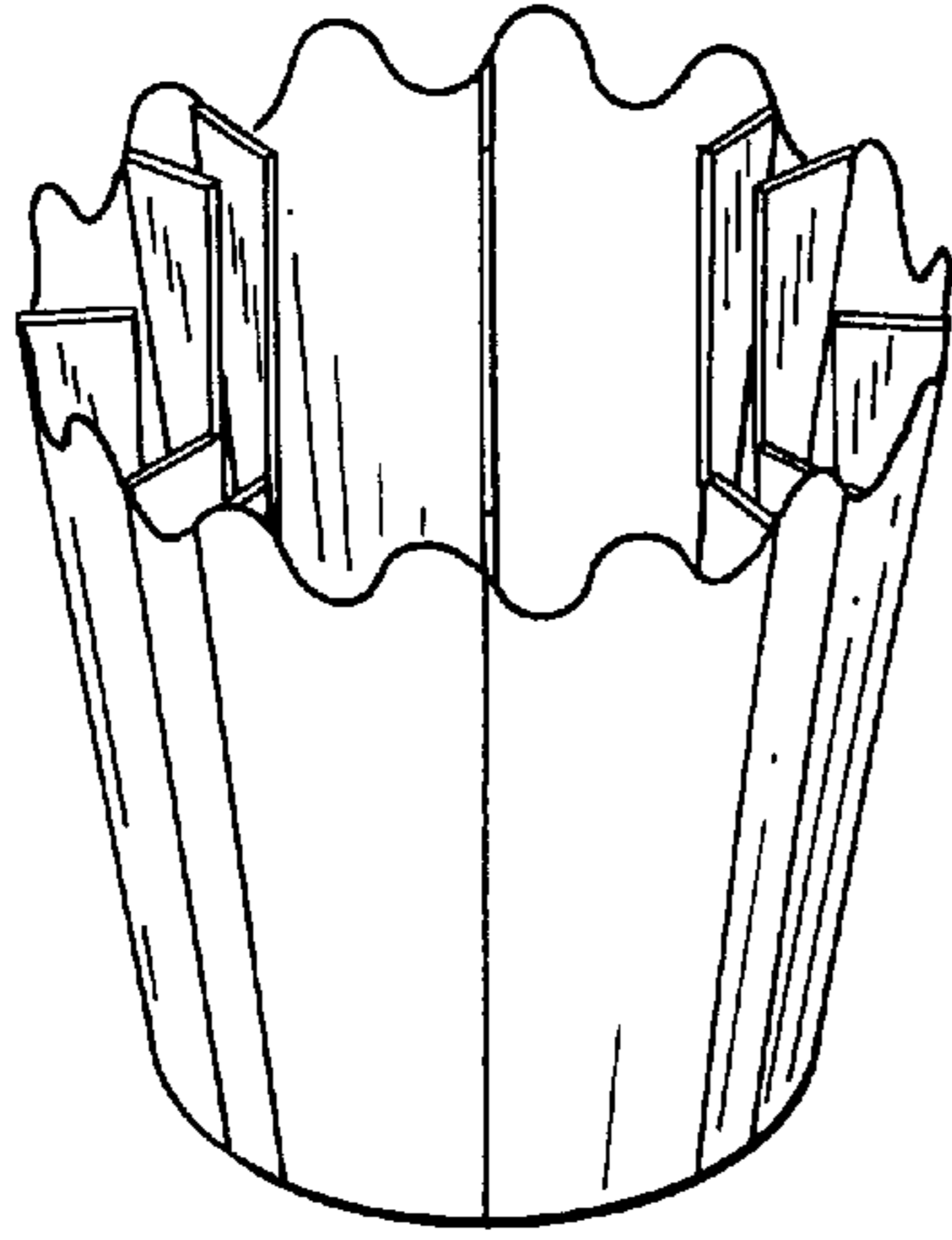

FIG. 9

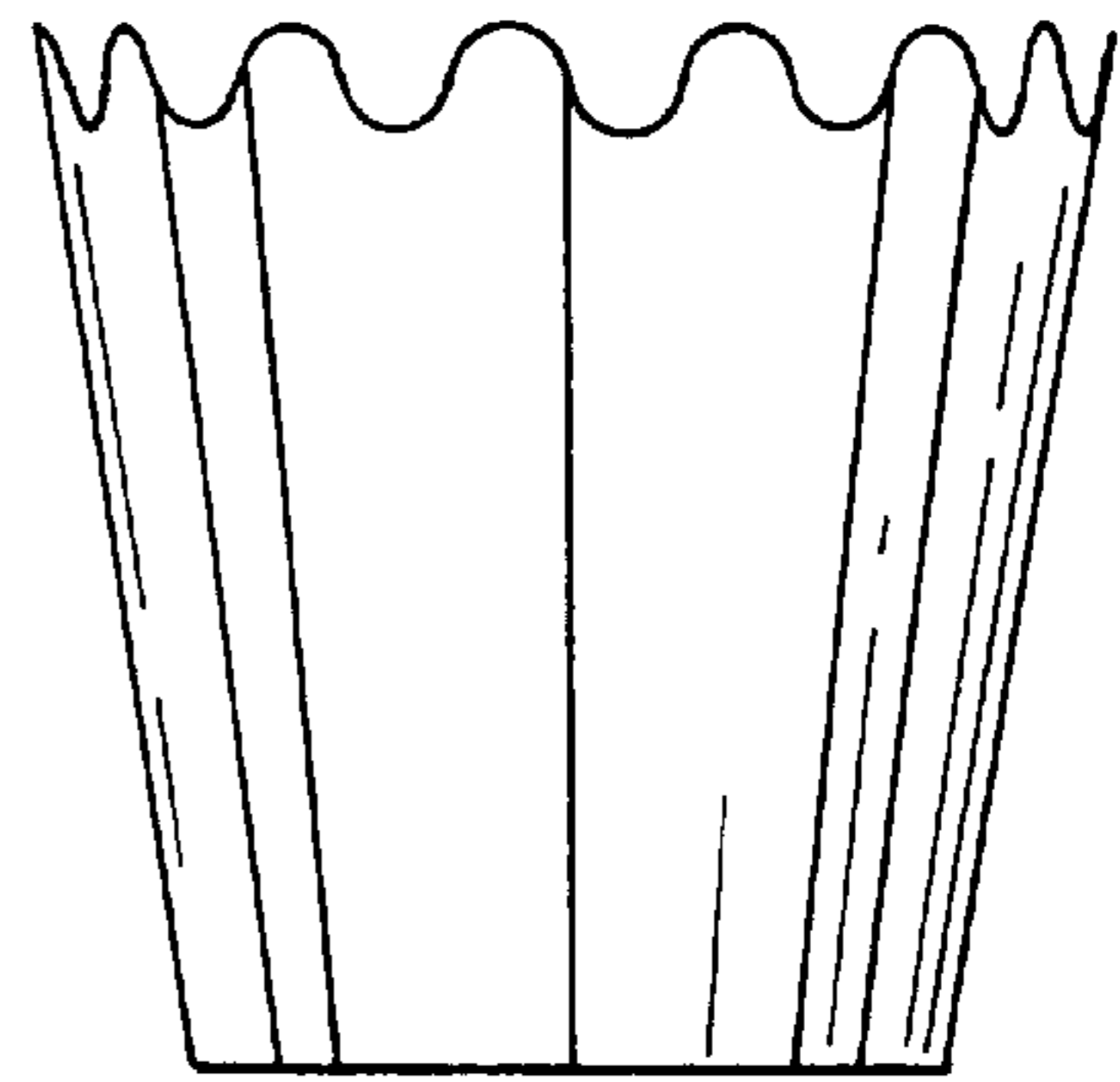

FIG. 10

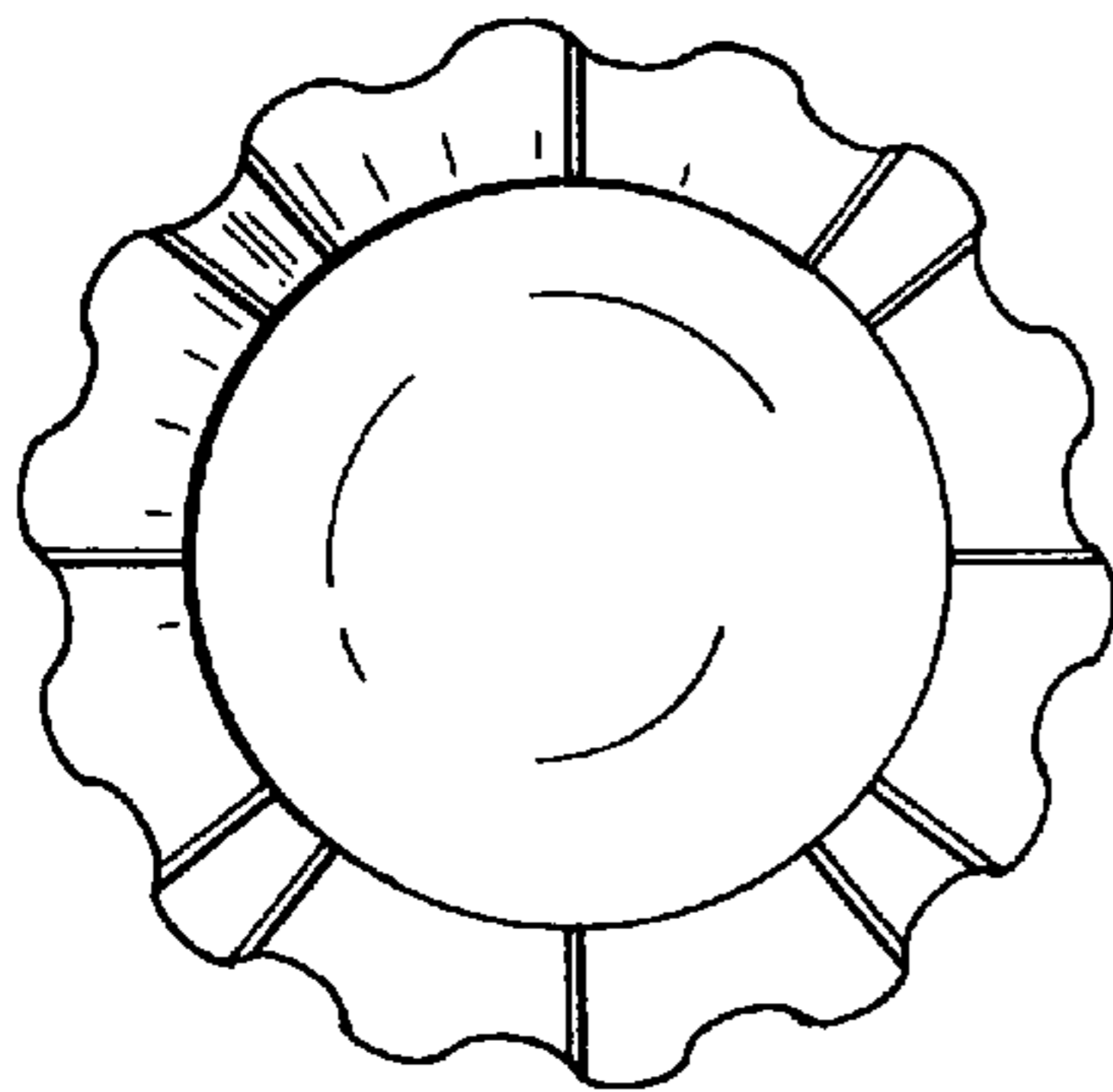

FIG. 11

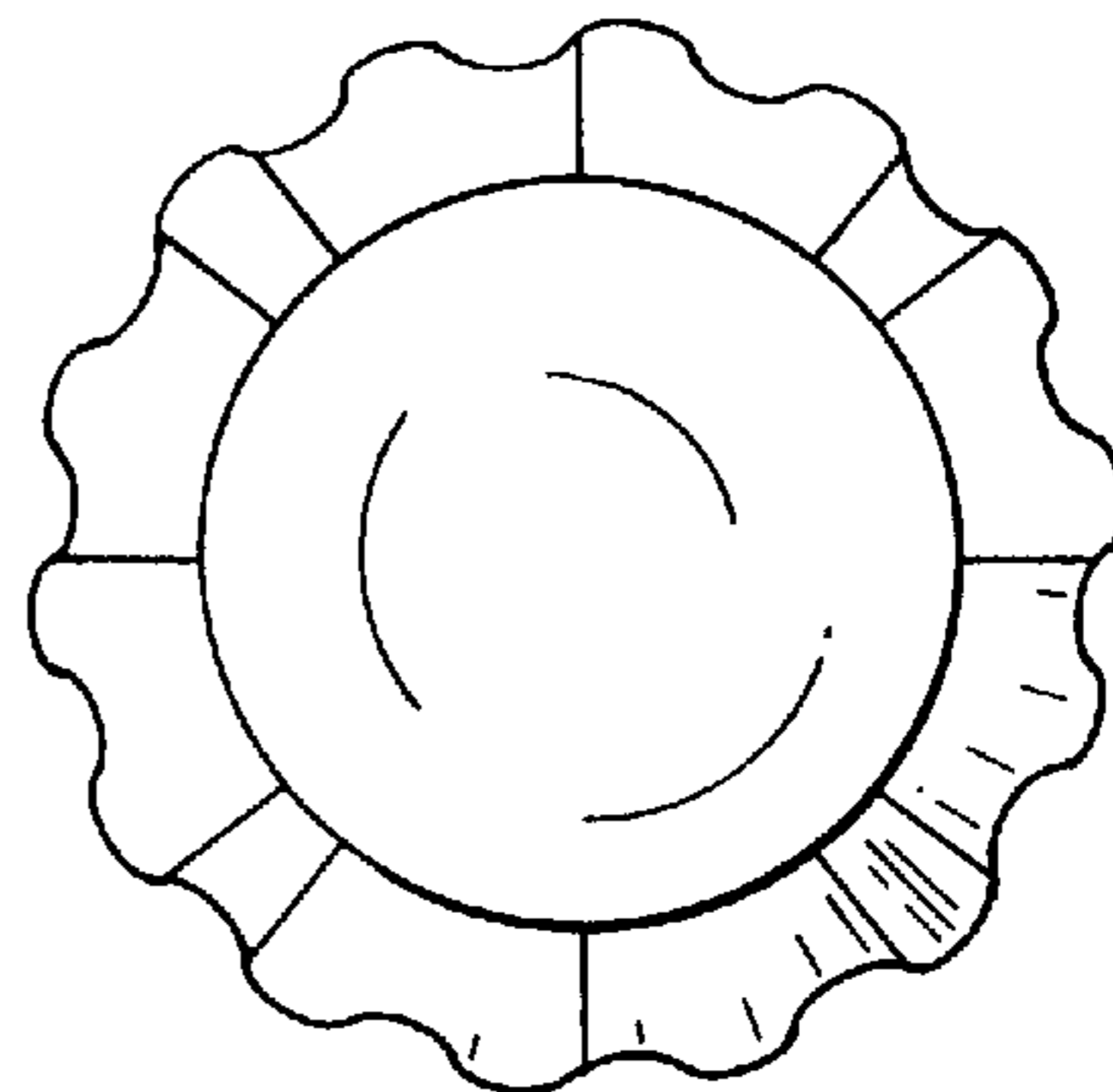

FIG. 12

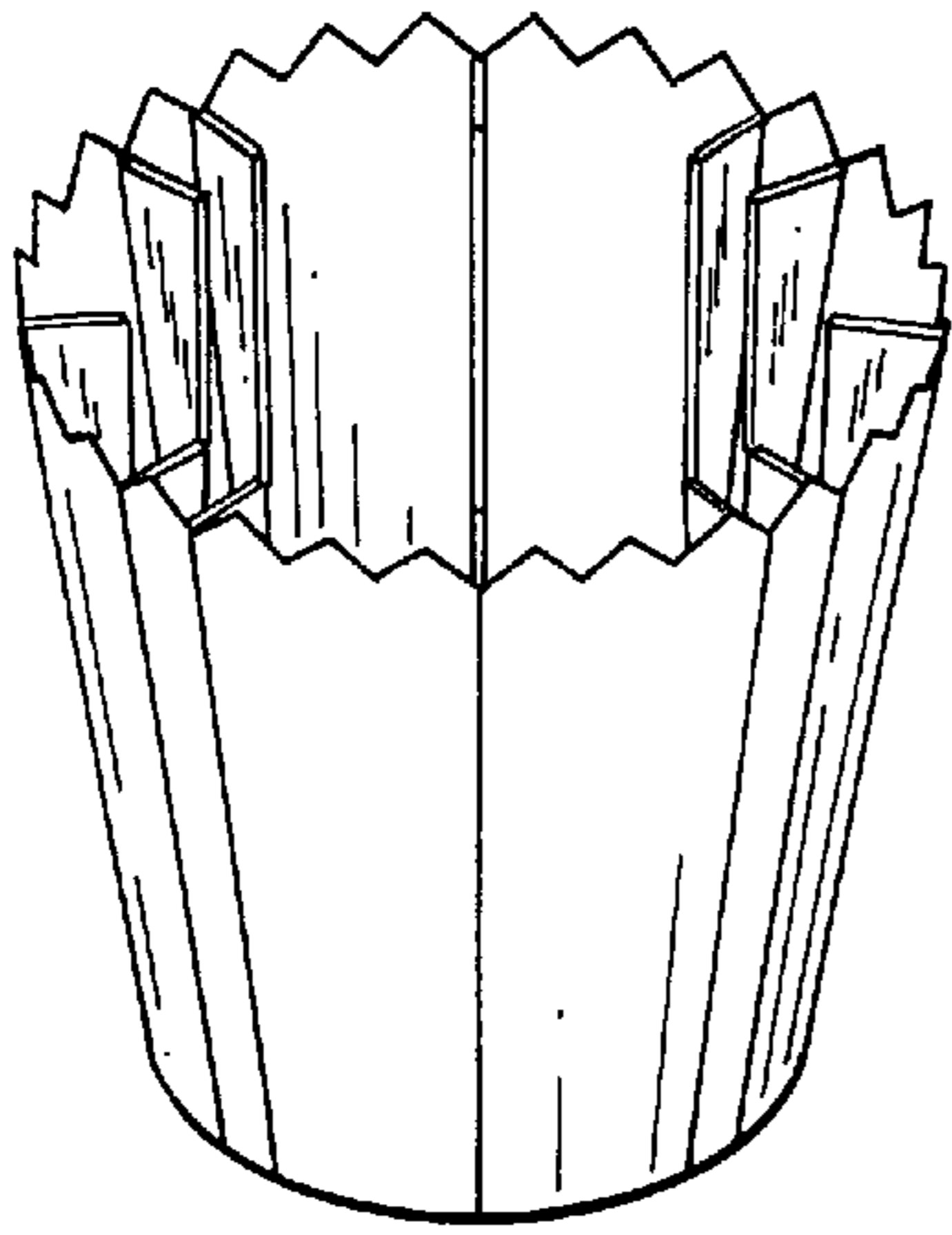

FIG. 13

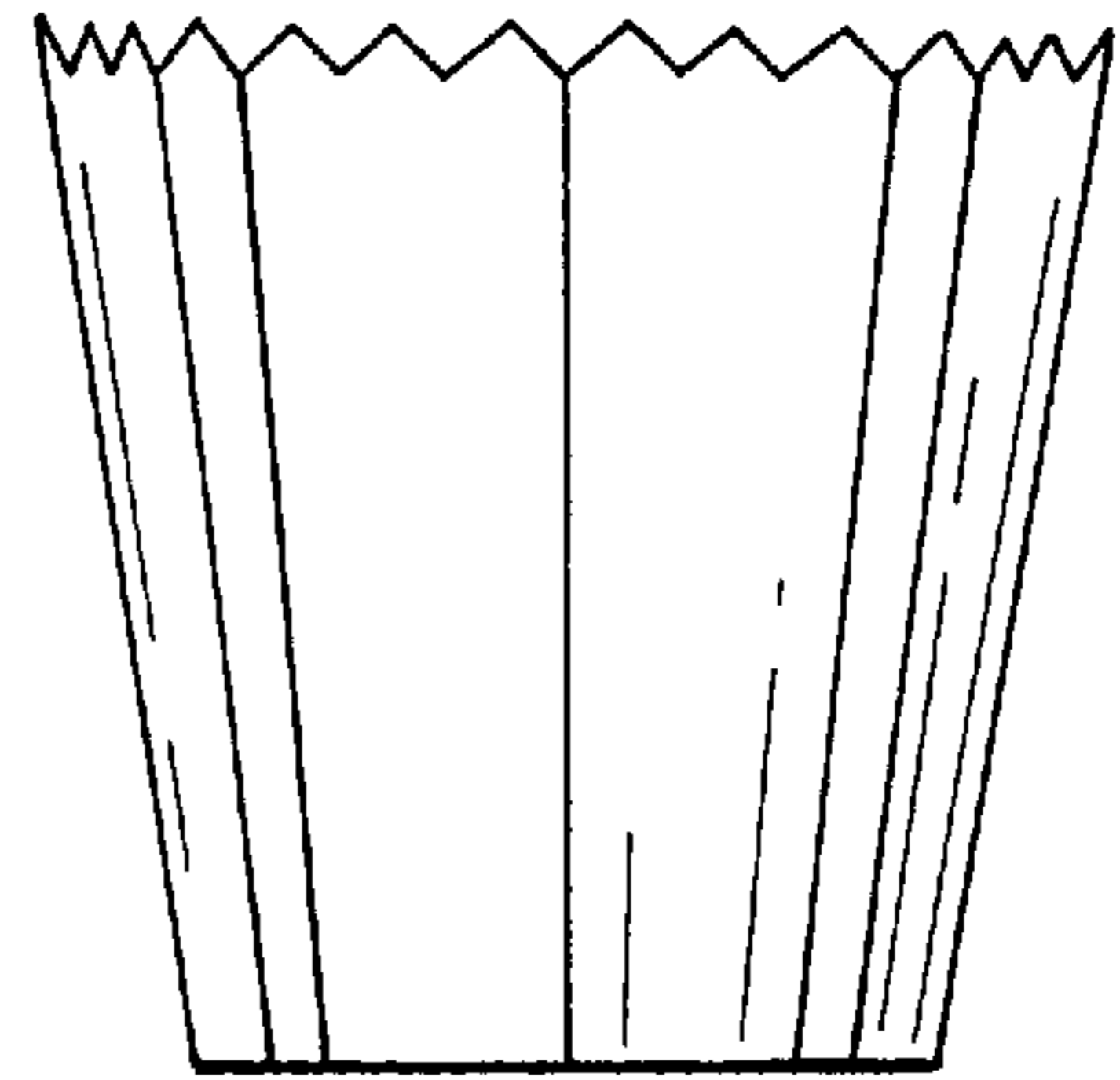

FIG. 14

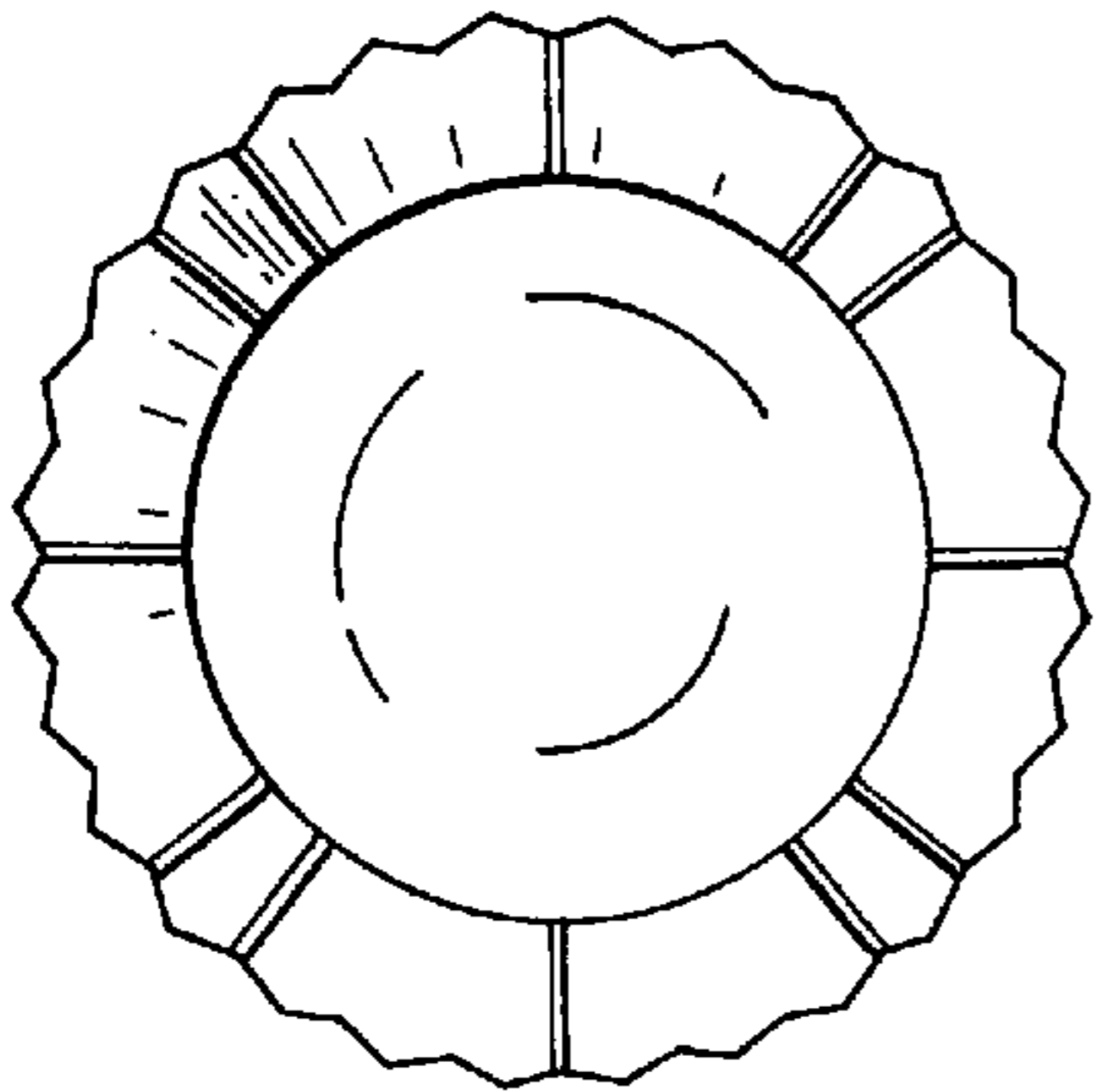

FIG. 15

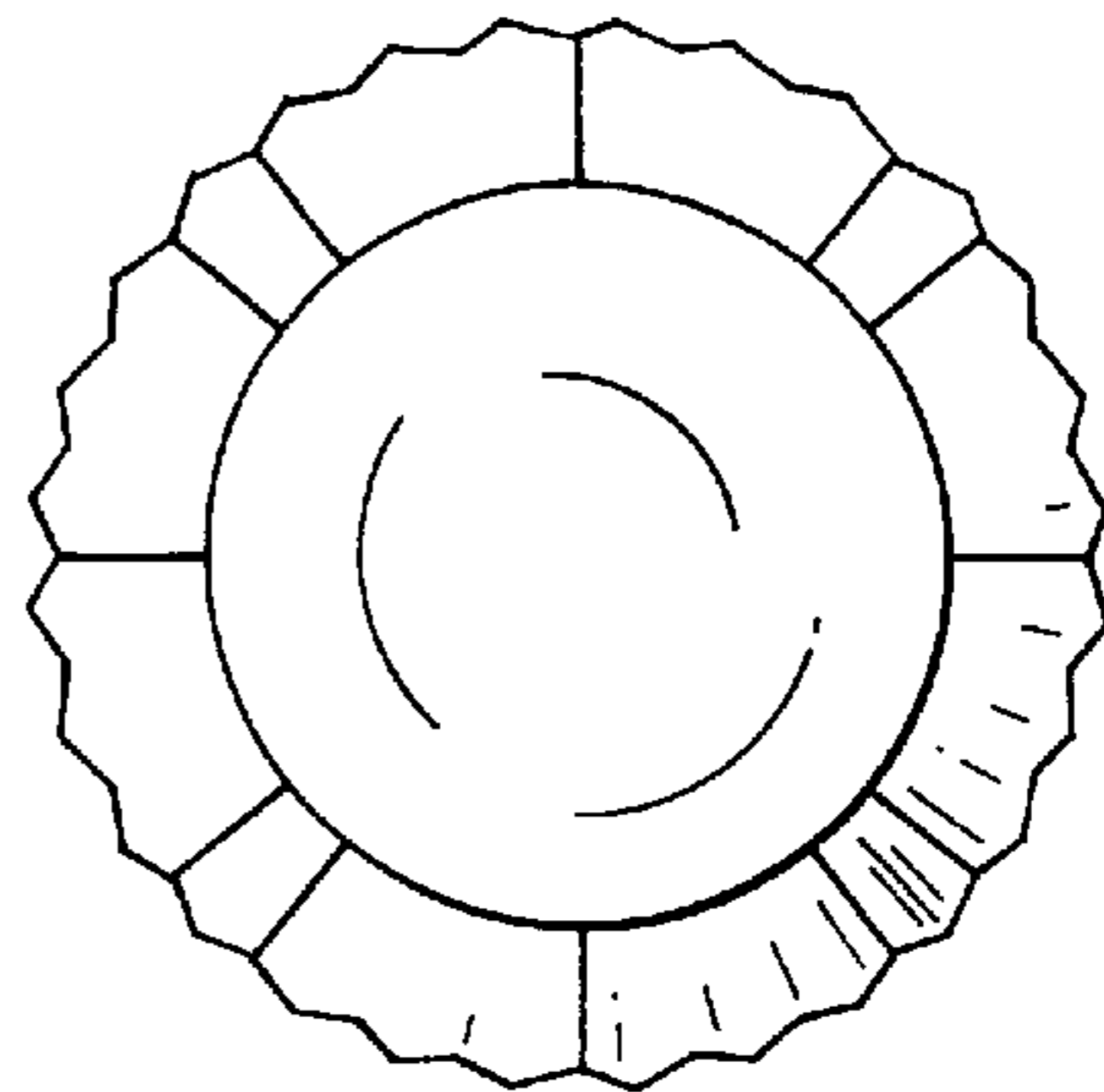

FIG. 16

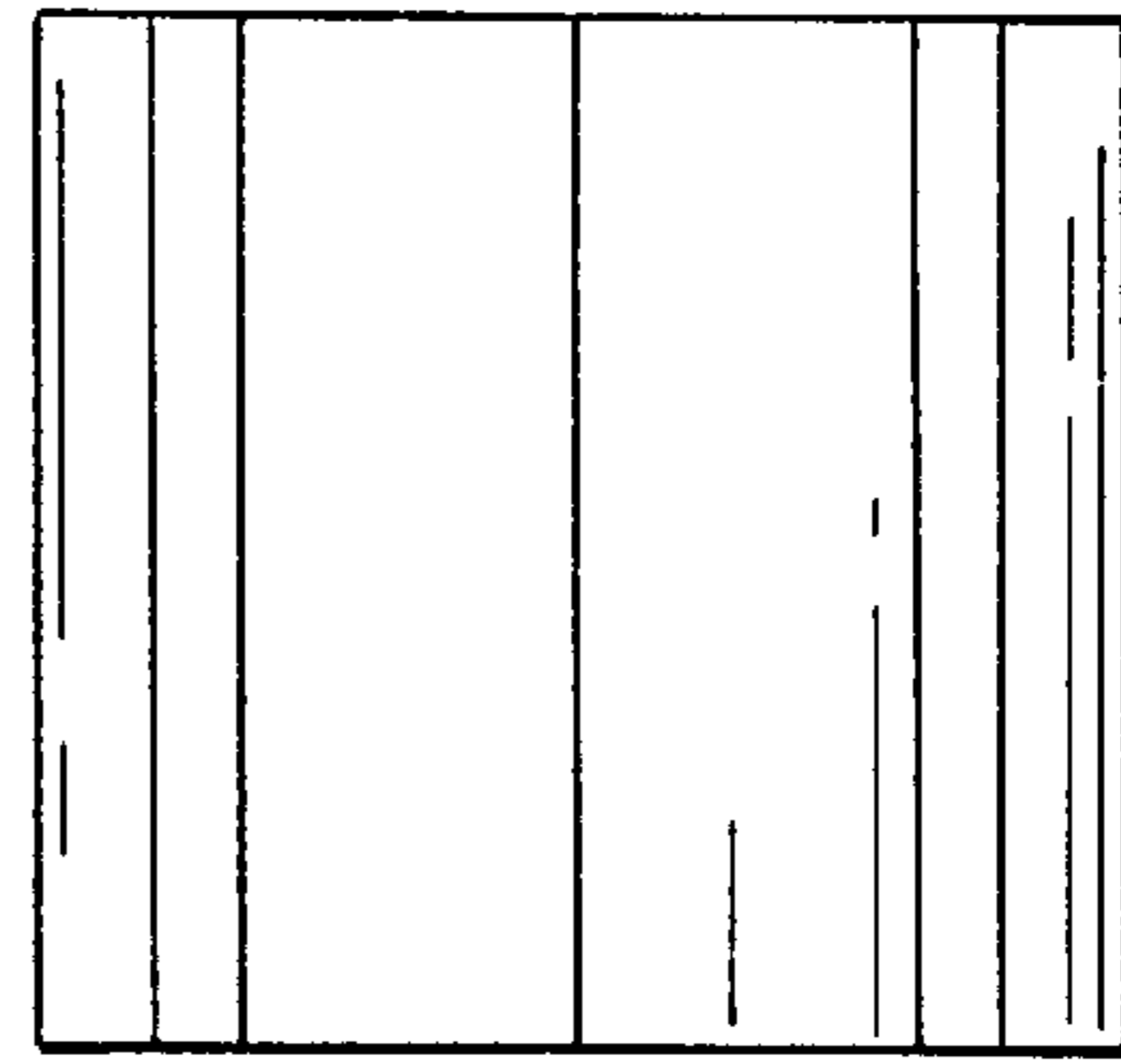
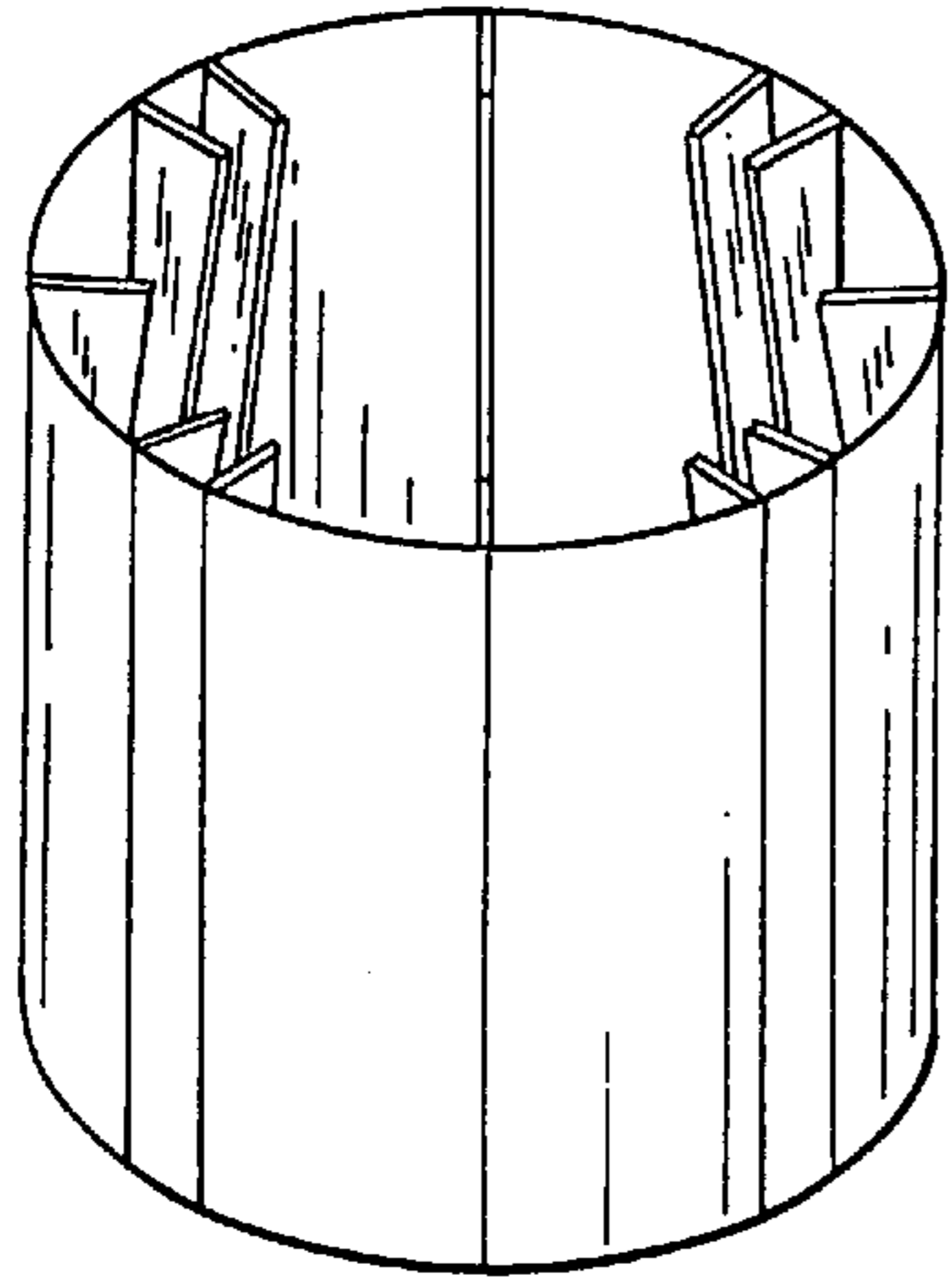

FIG. 17

FIG. 18

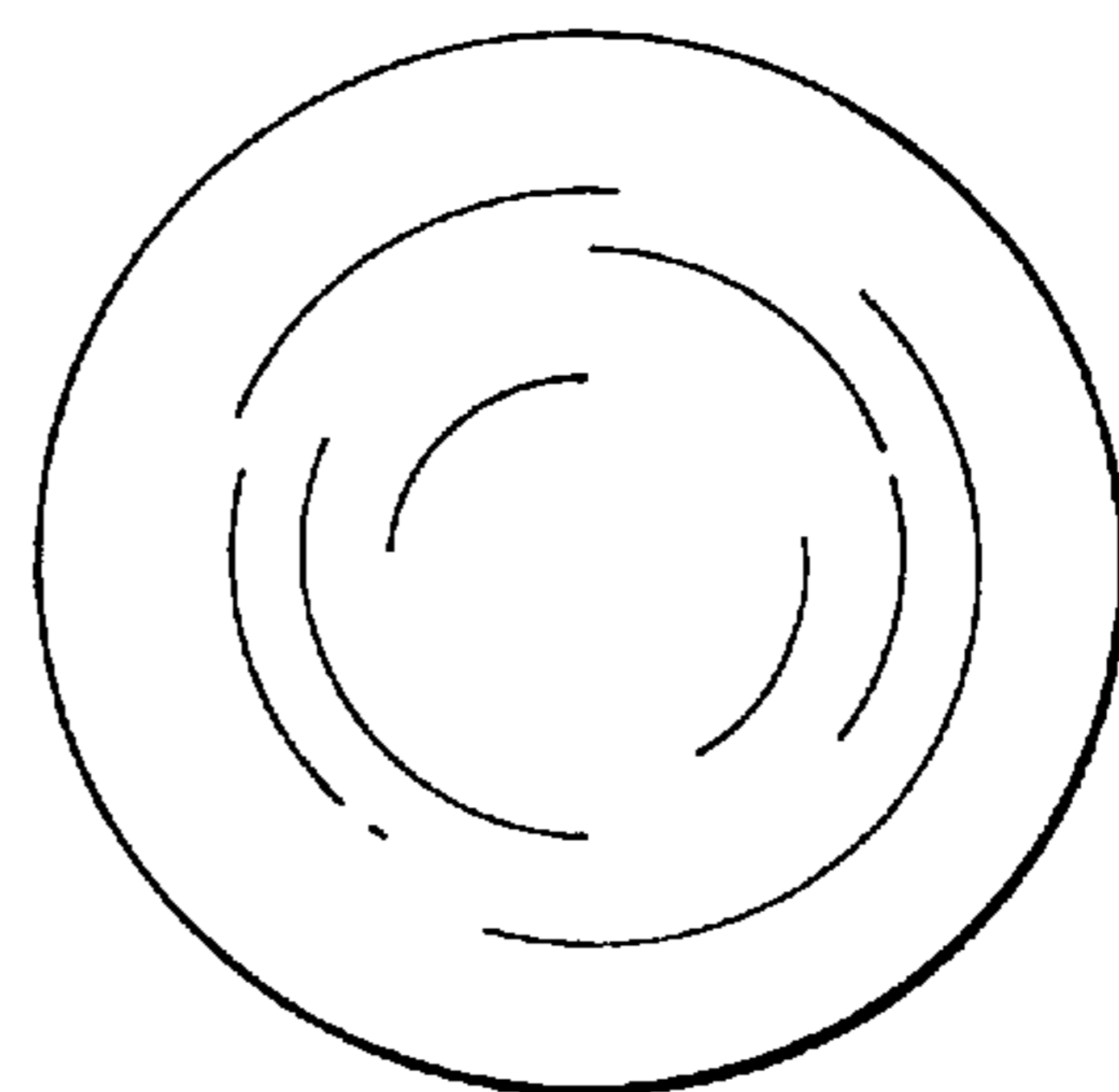
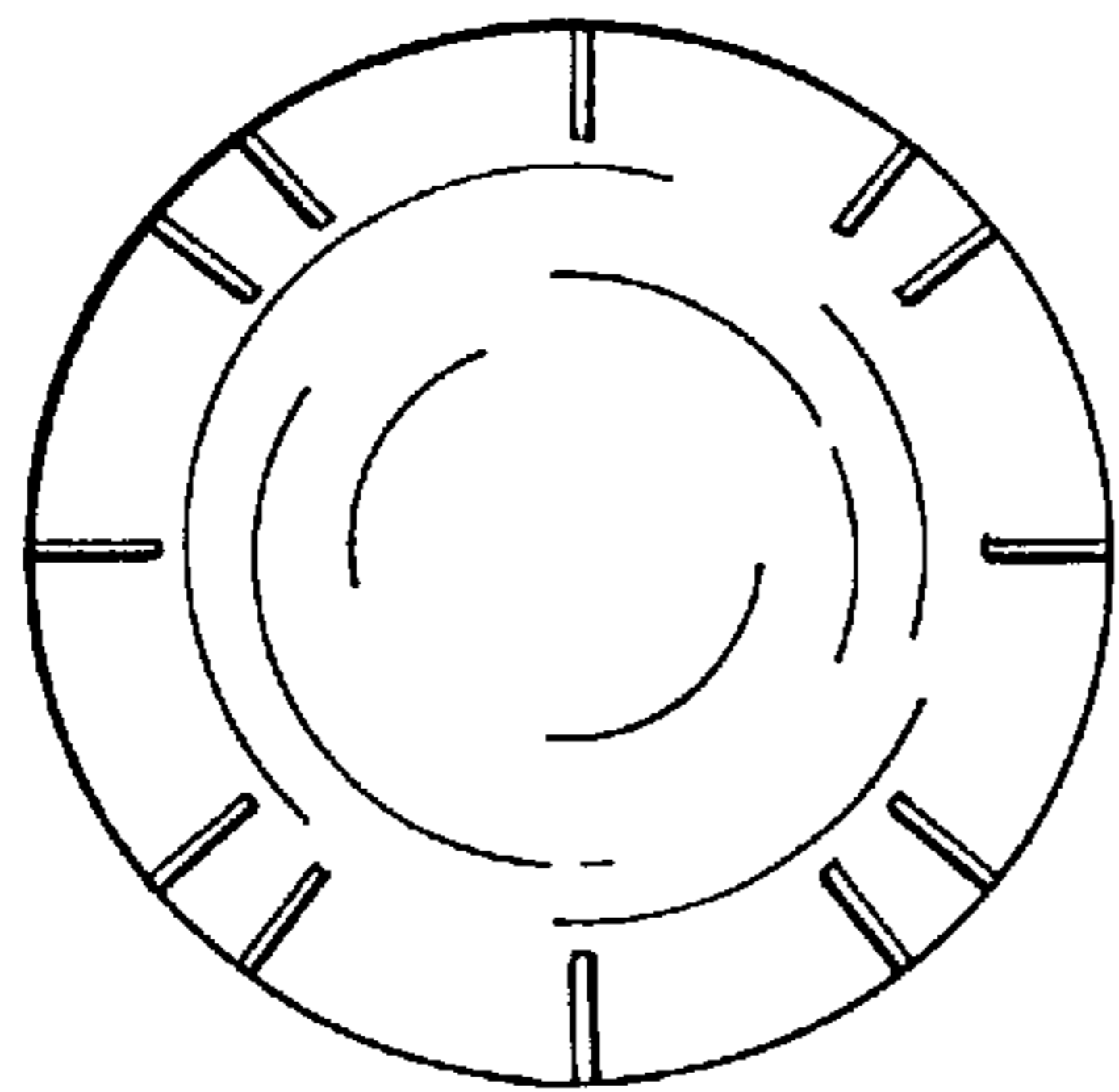

FIG. 19

FIG. 20

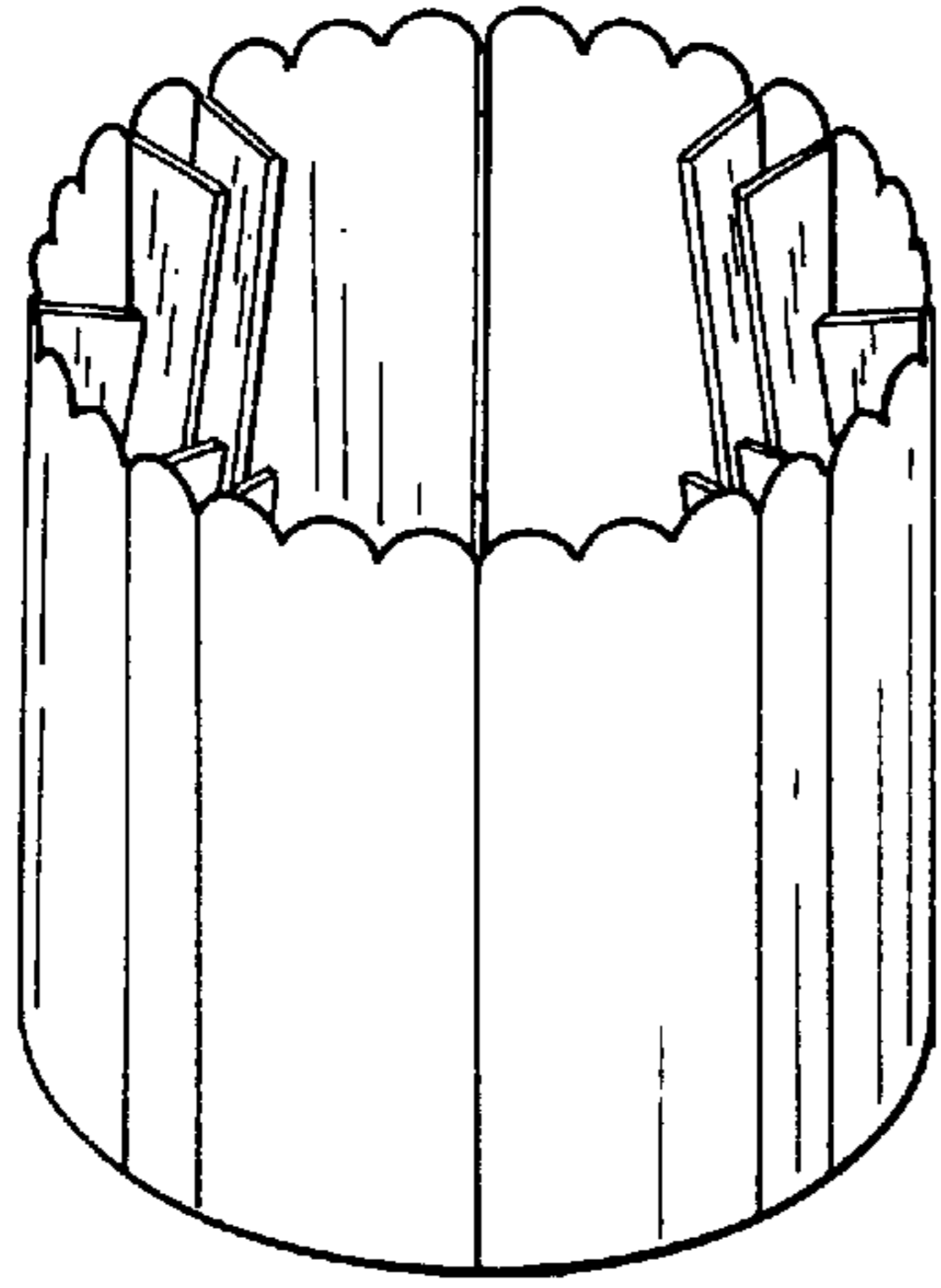

FIG. 21

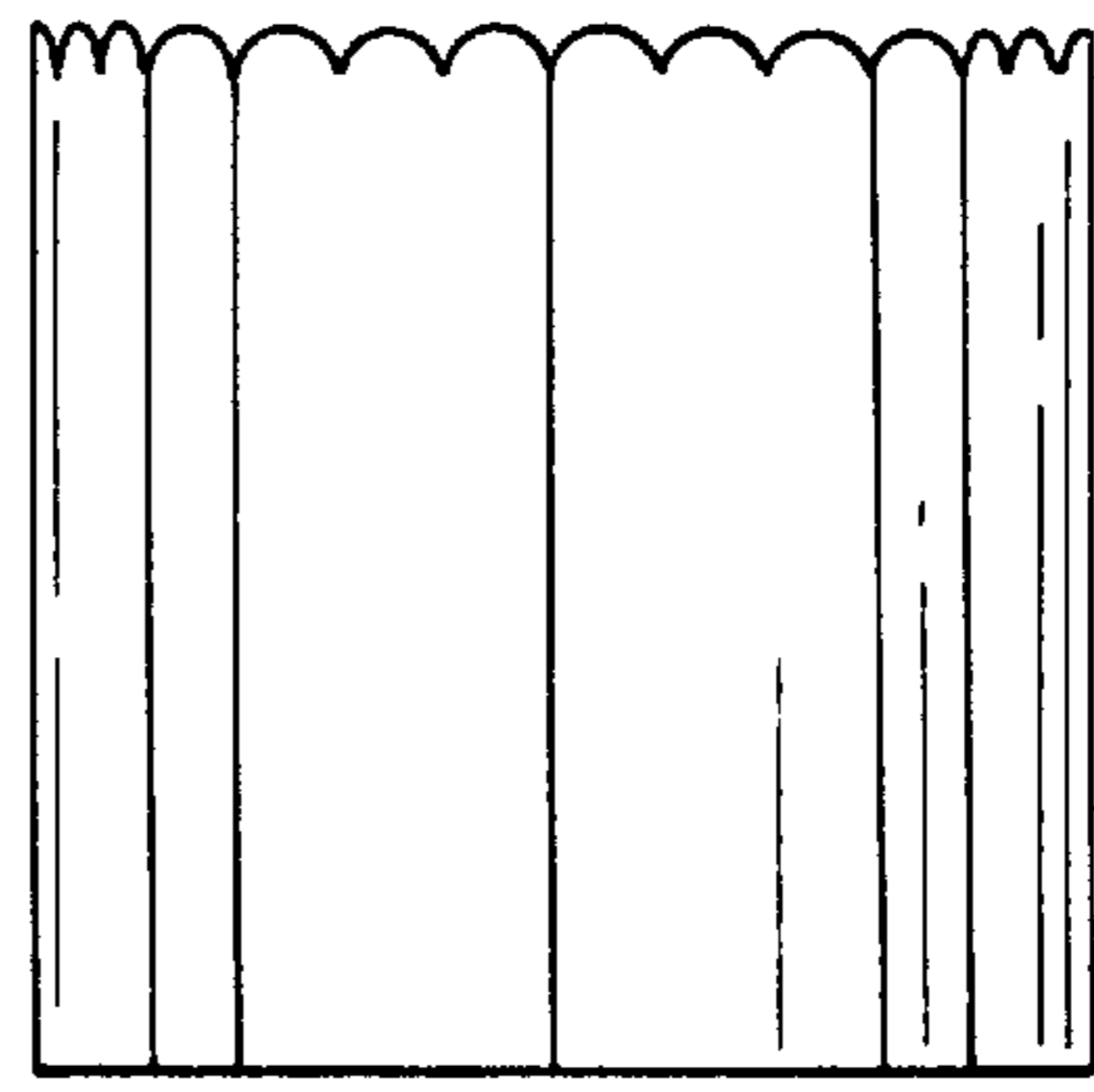

FIG. 22

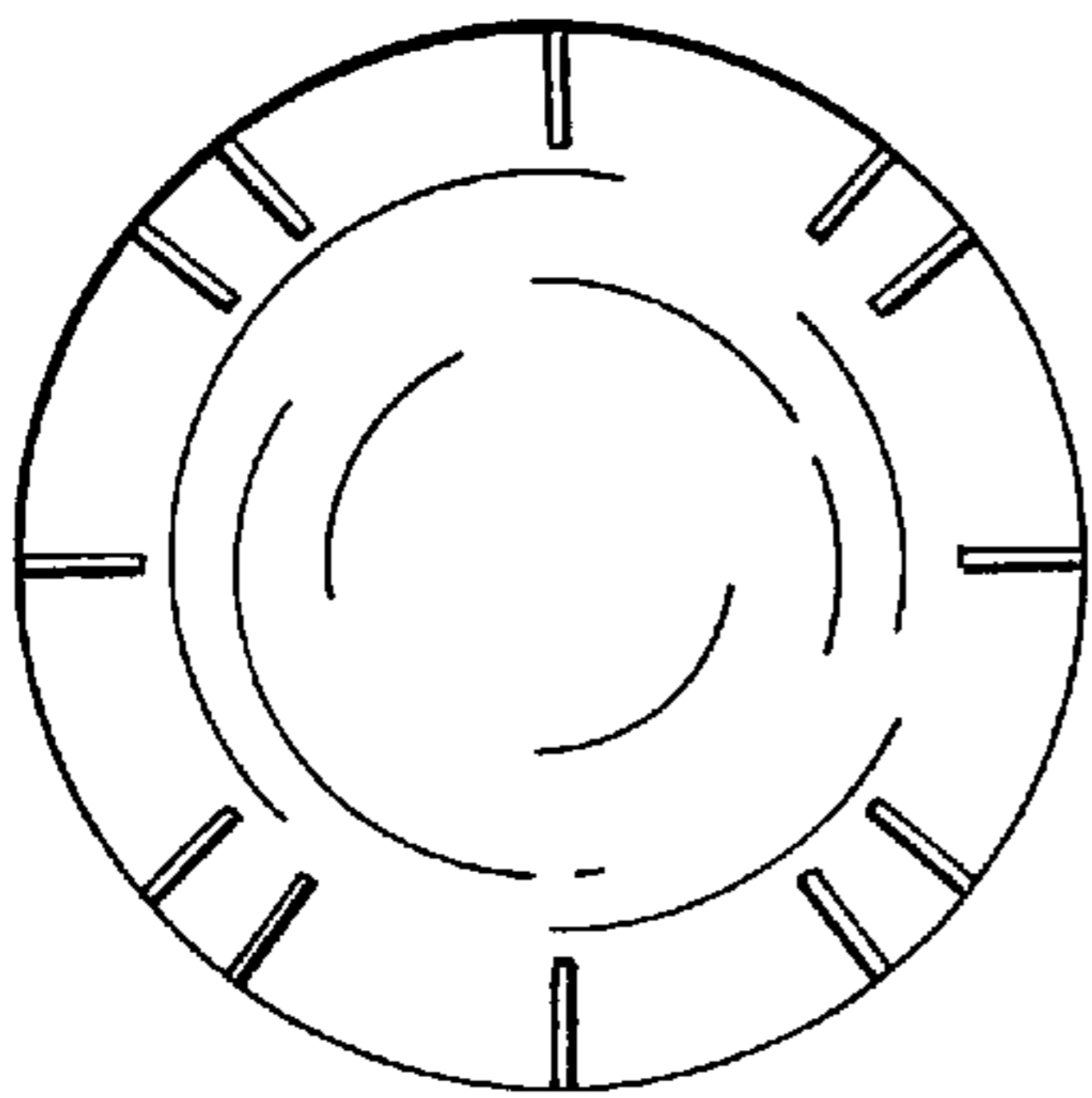

FIG. 23

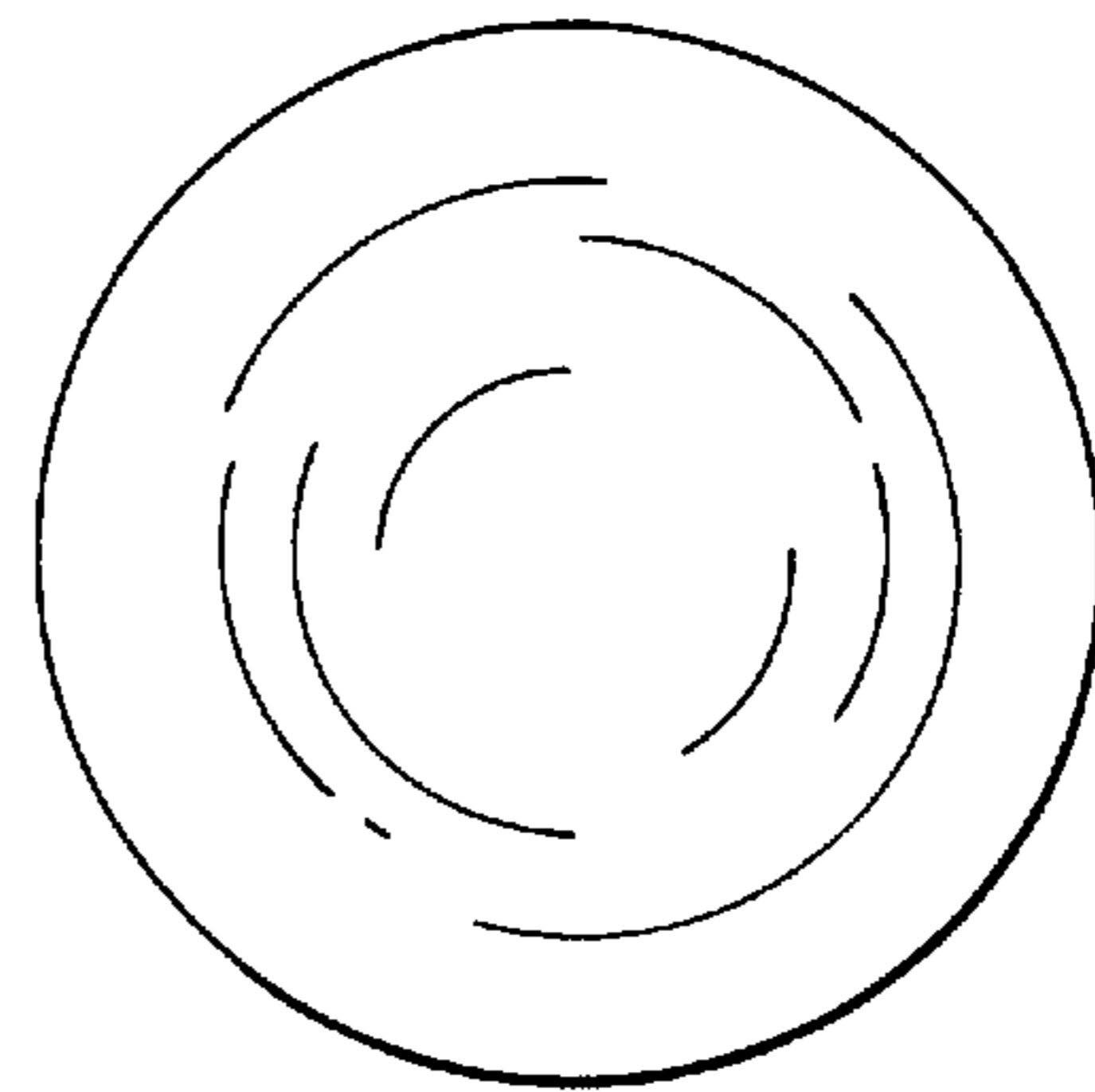

FIG. 24

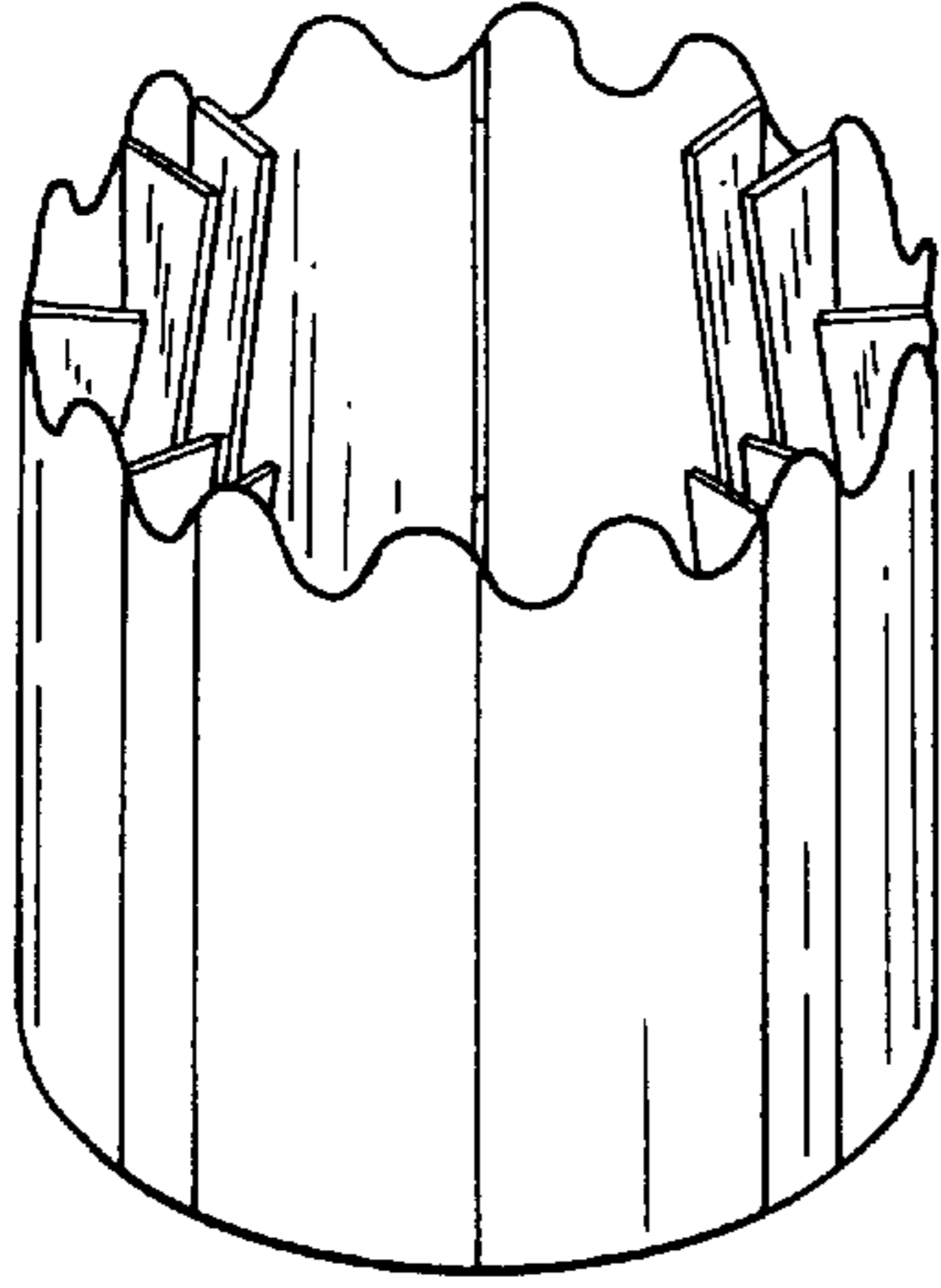

FIG. 25

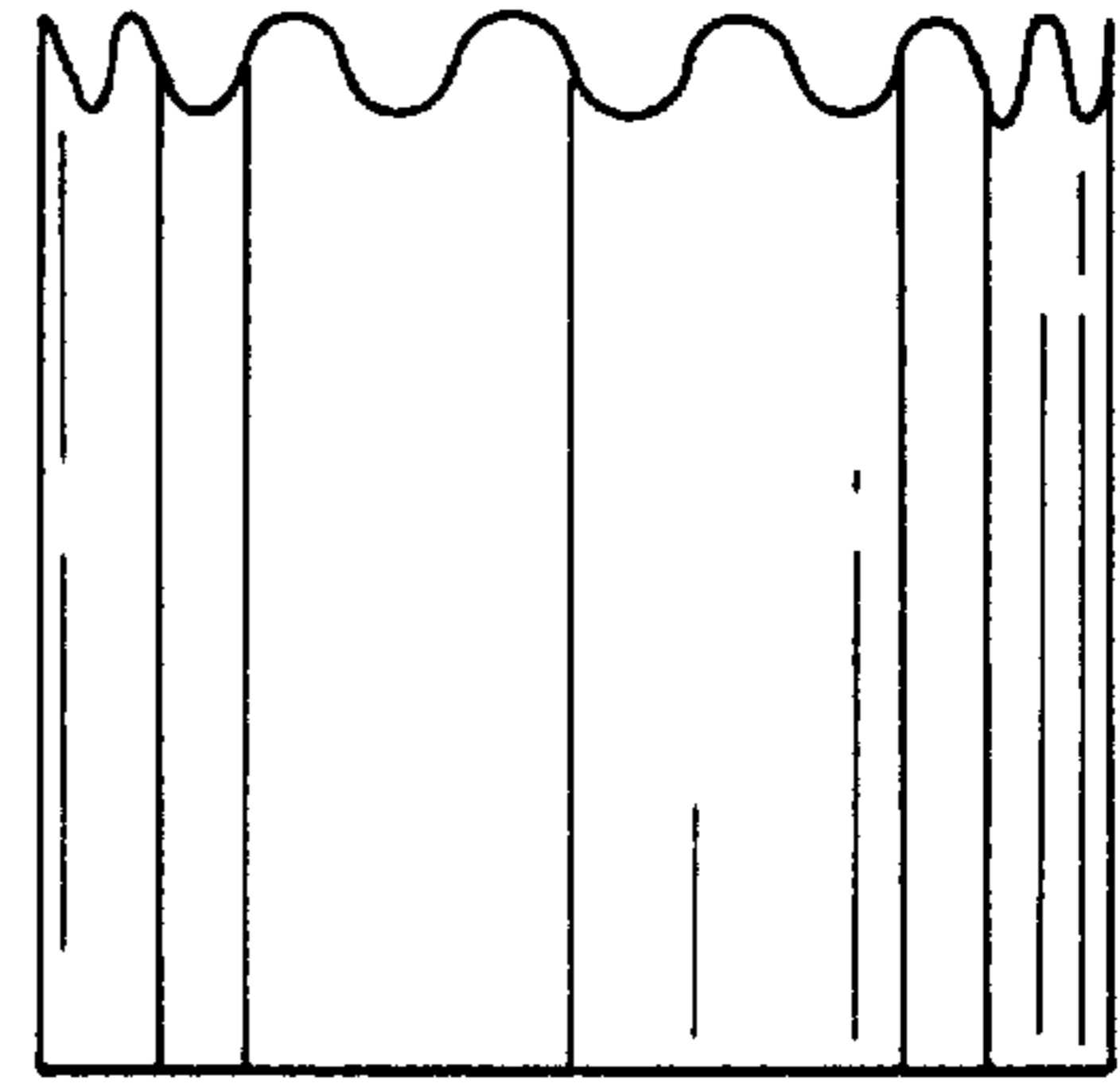

FIG. 26

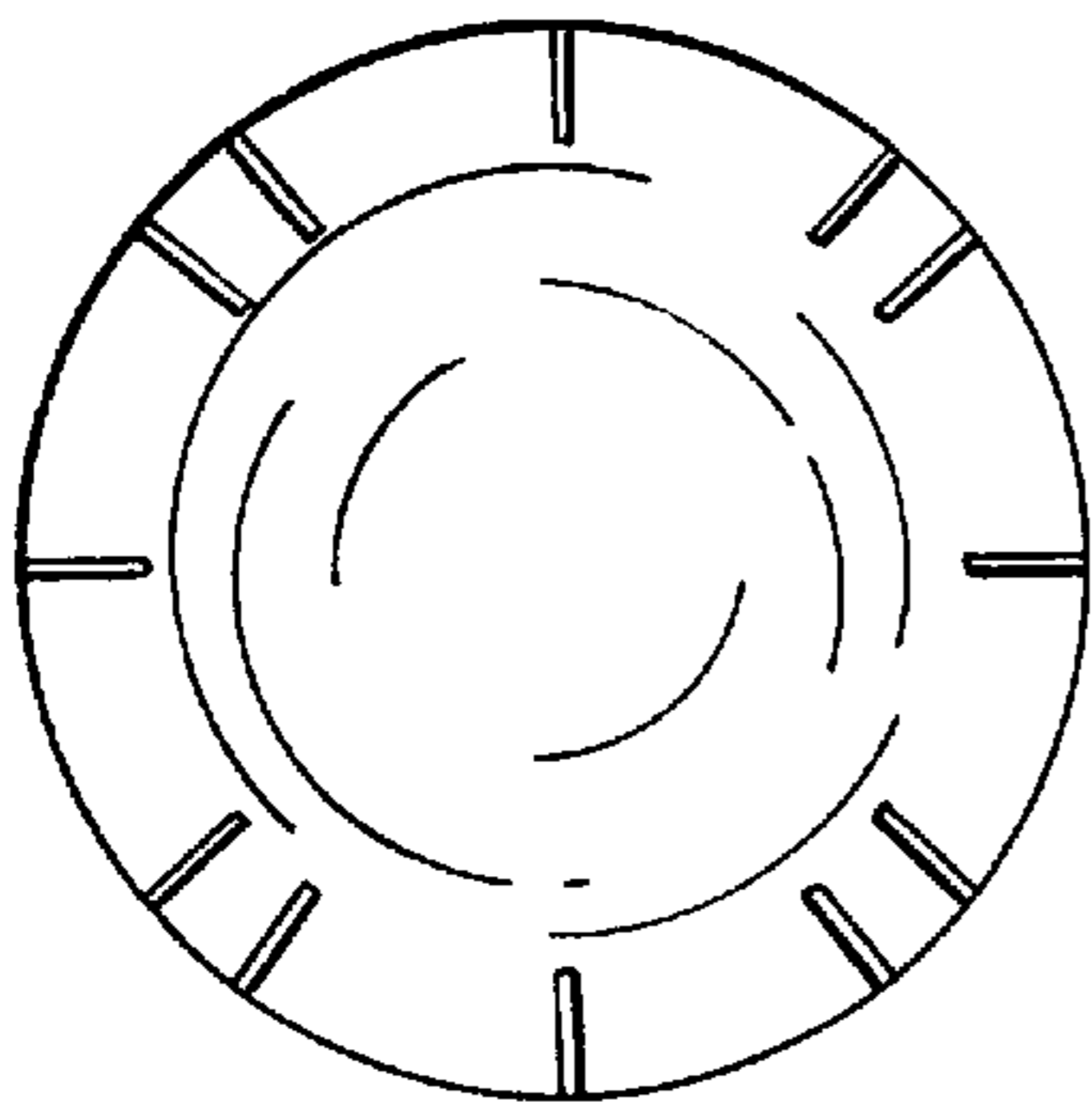

FIG. 27

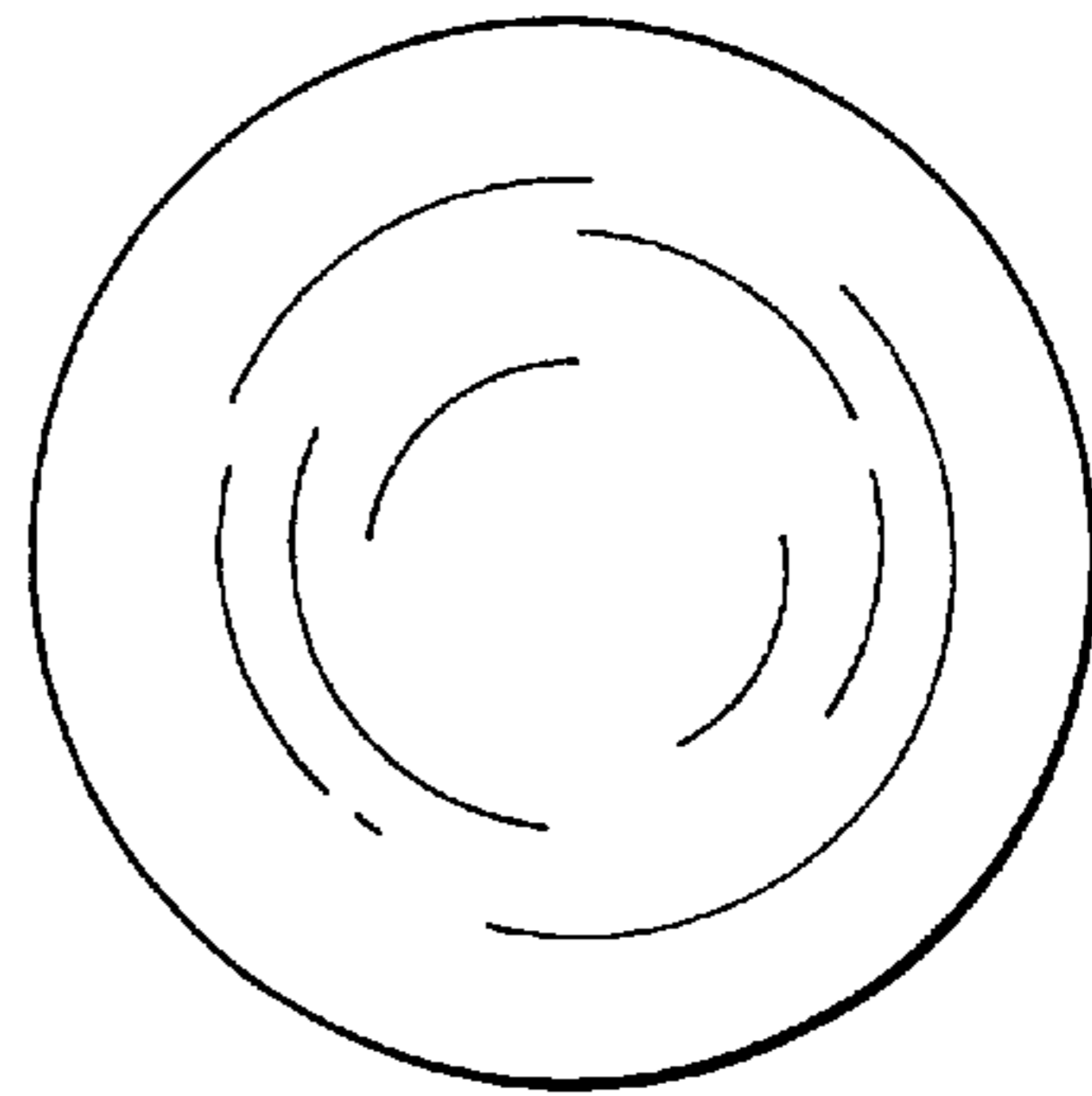

FIG. 28

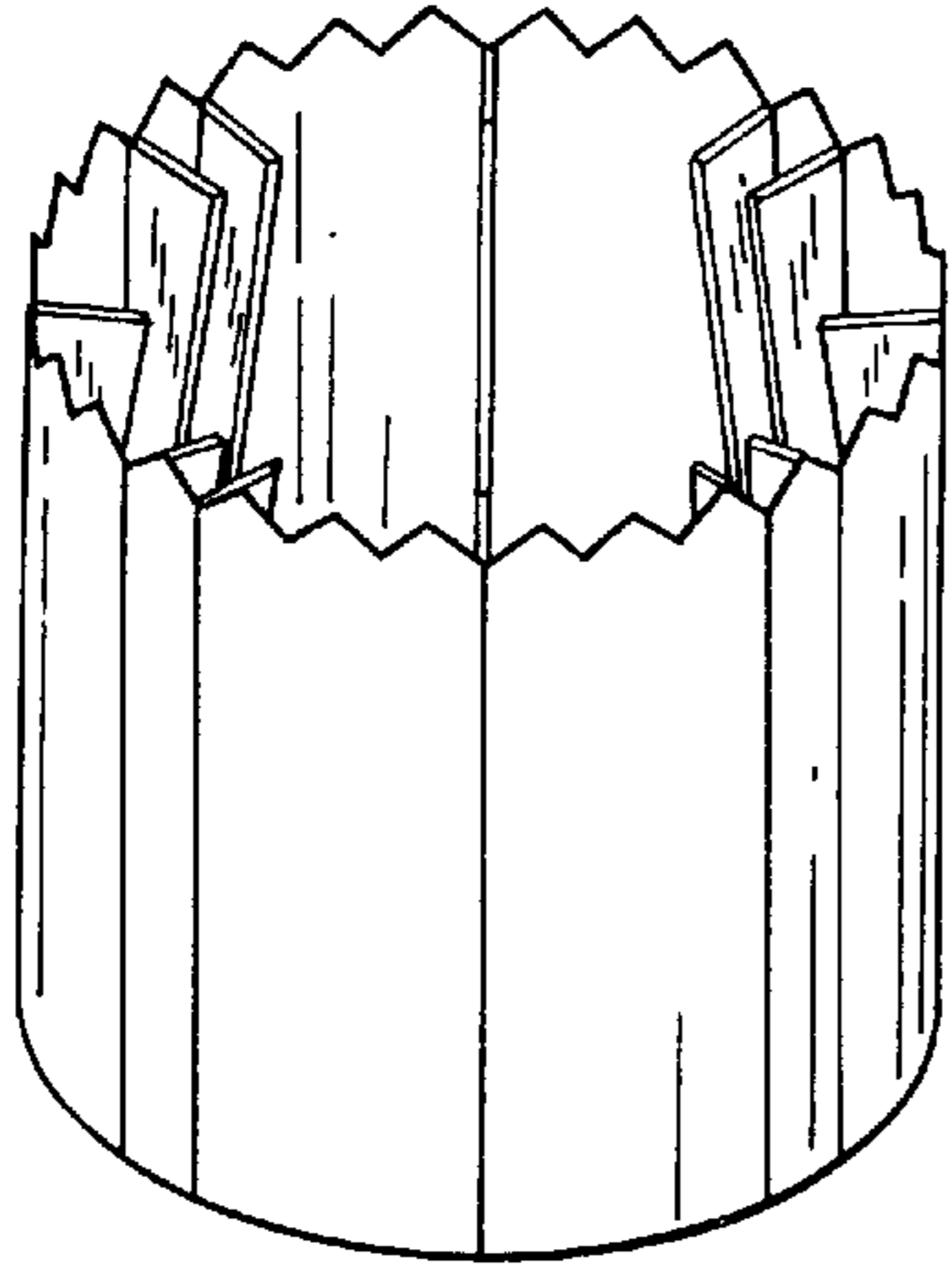

FIG. 28

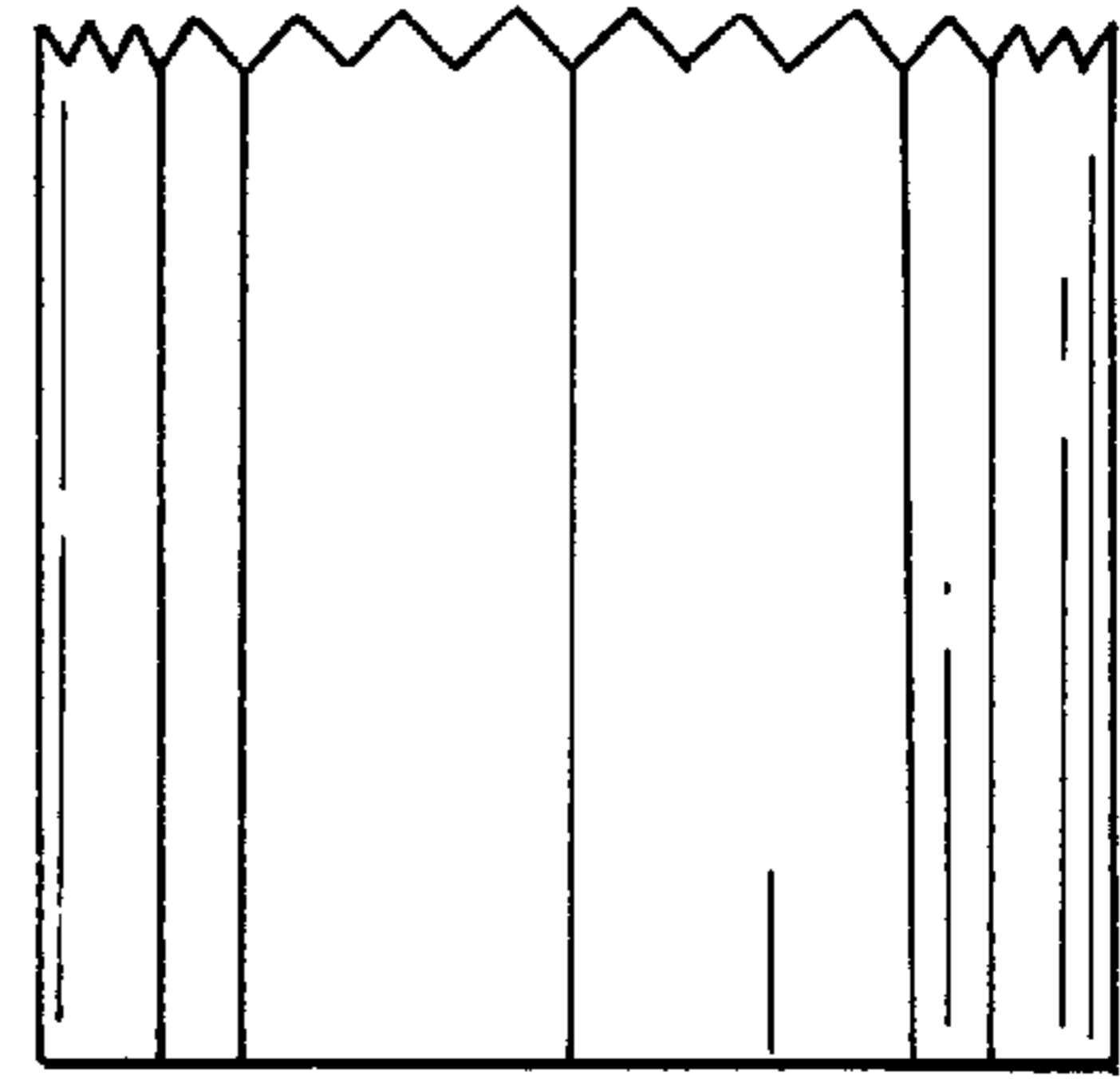

FIG. 29

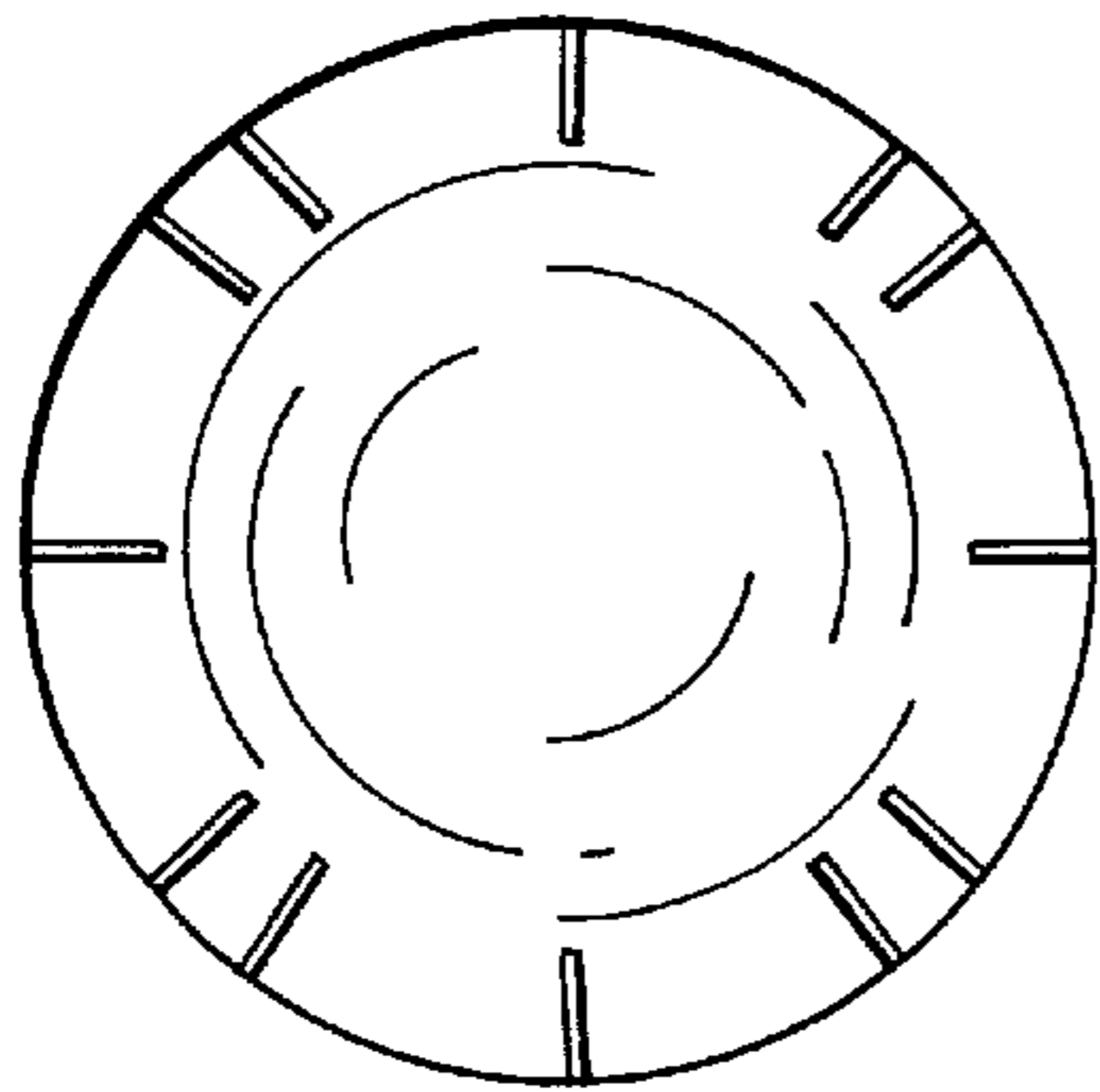

FIG. 31

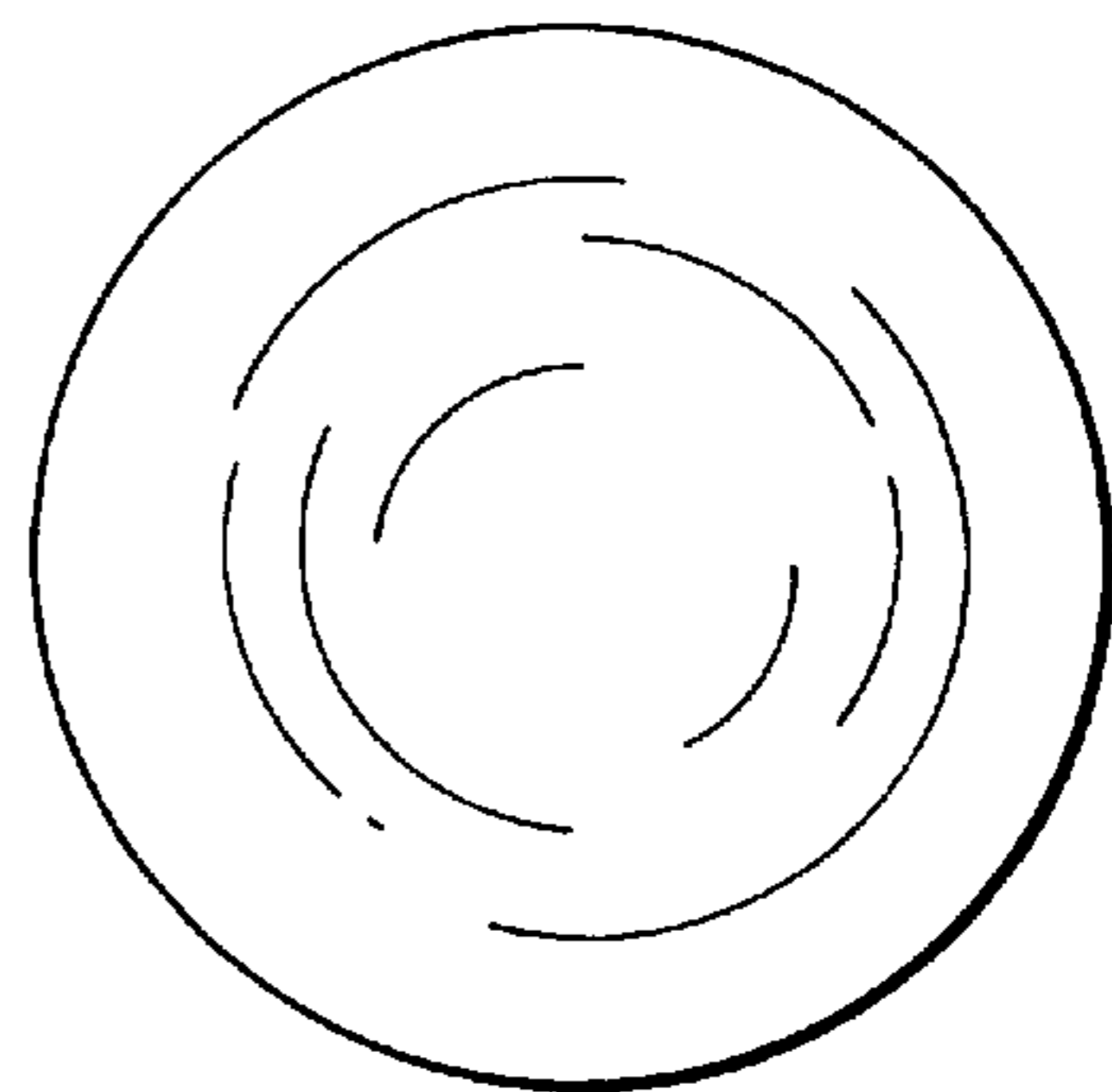

FIG. 32

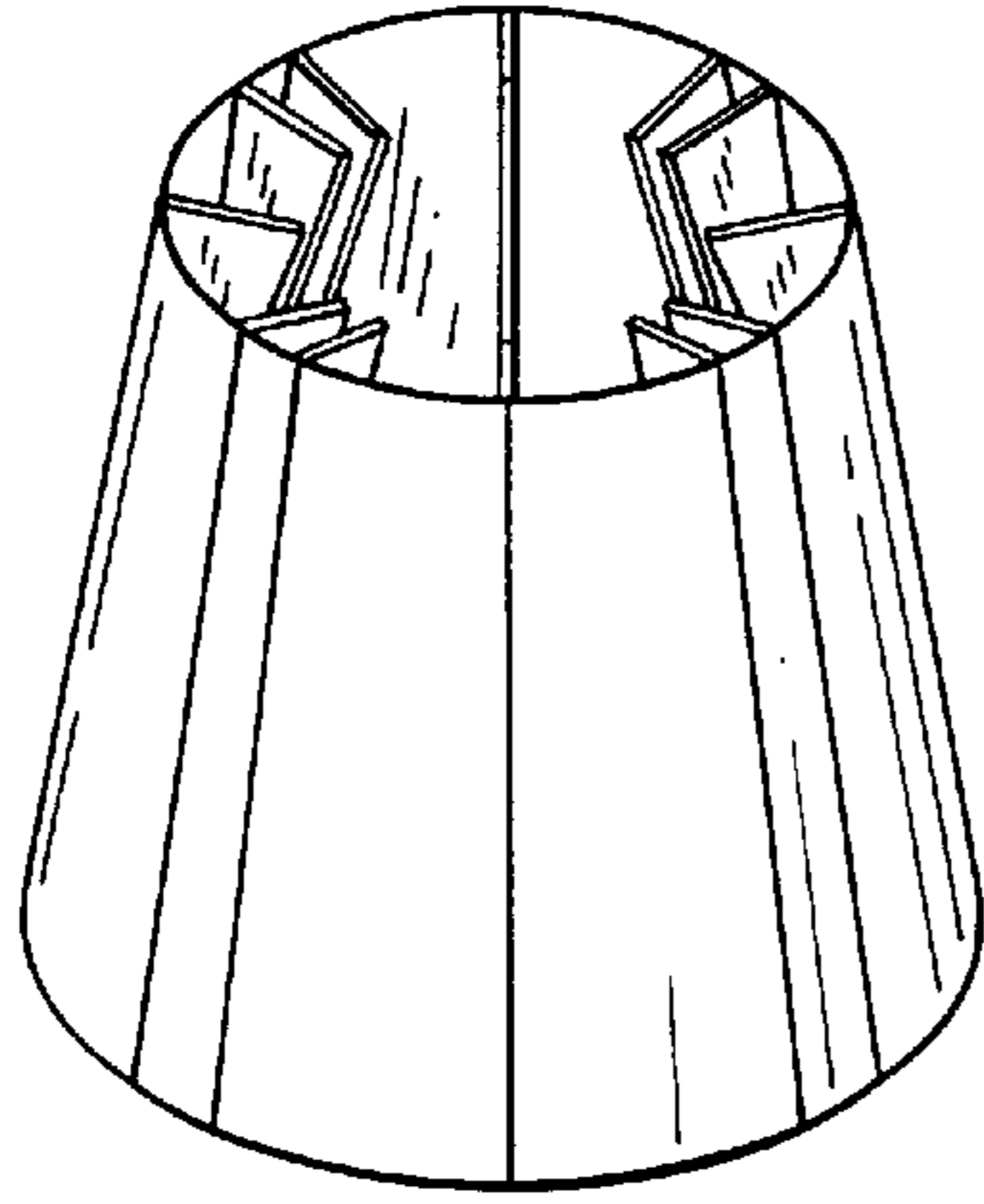

FIG. 33

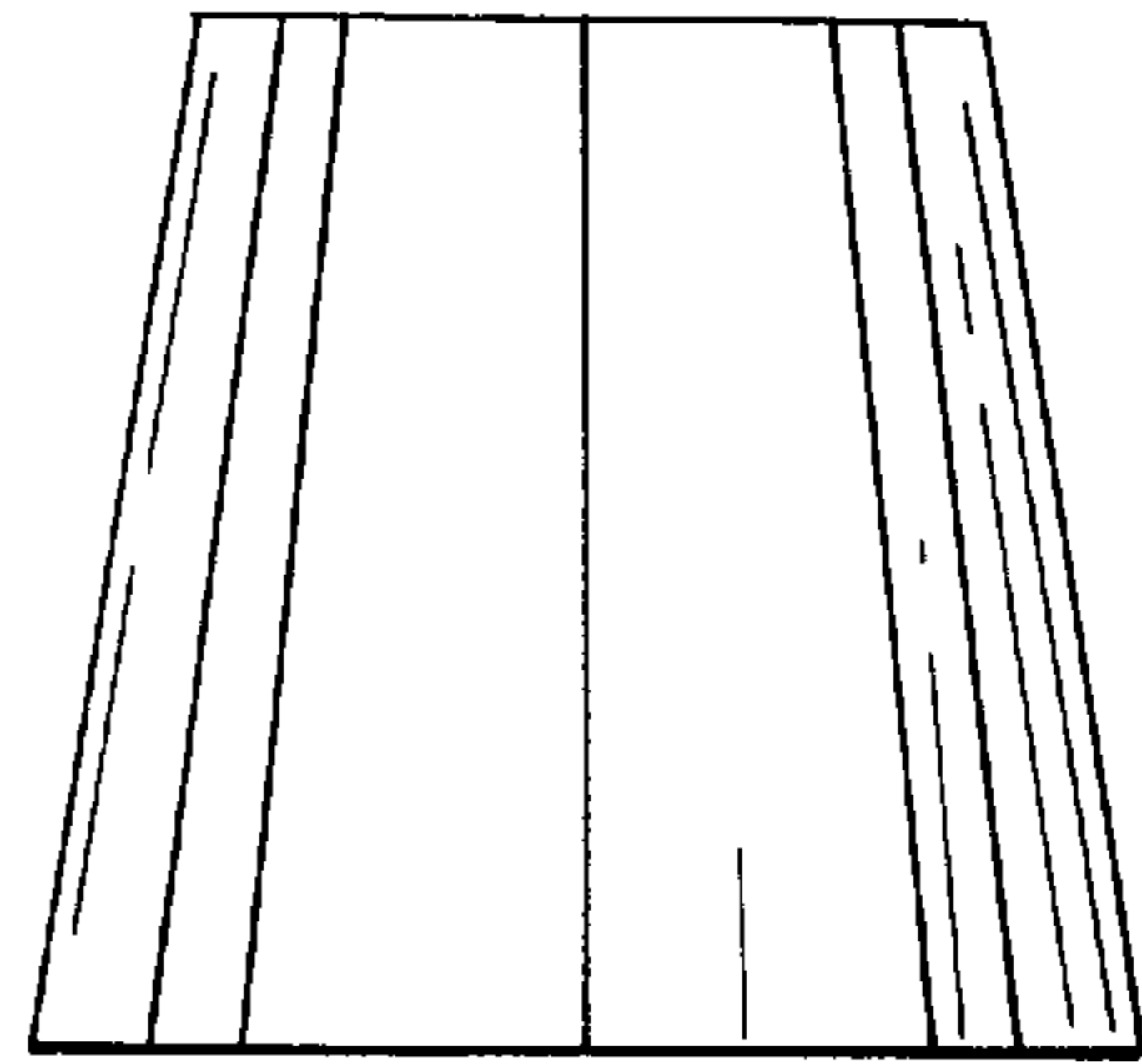

FIG. 34

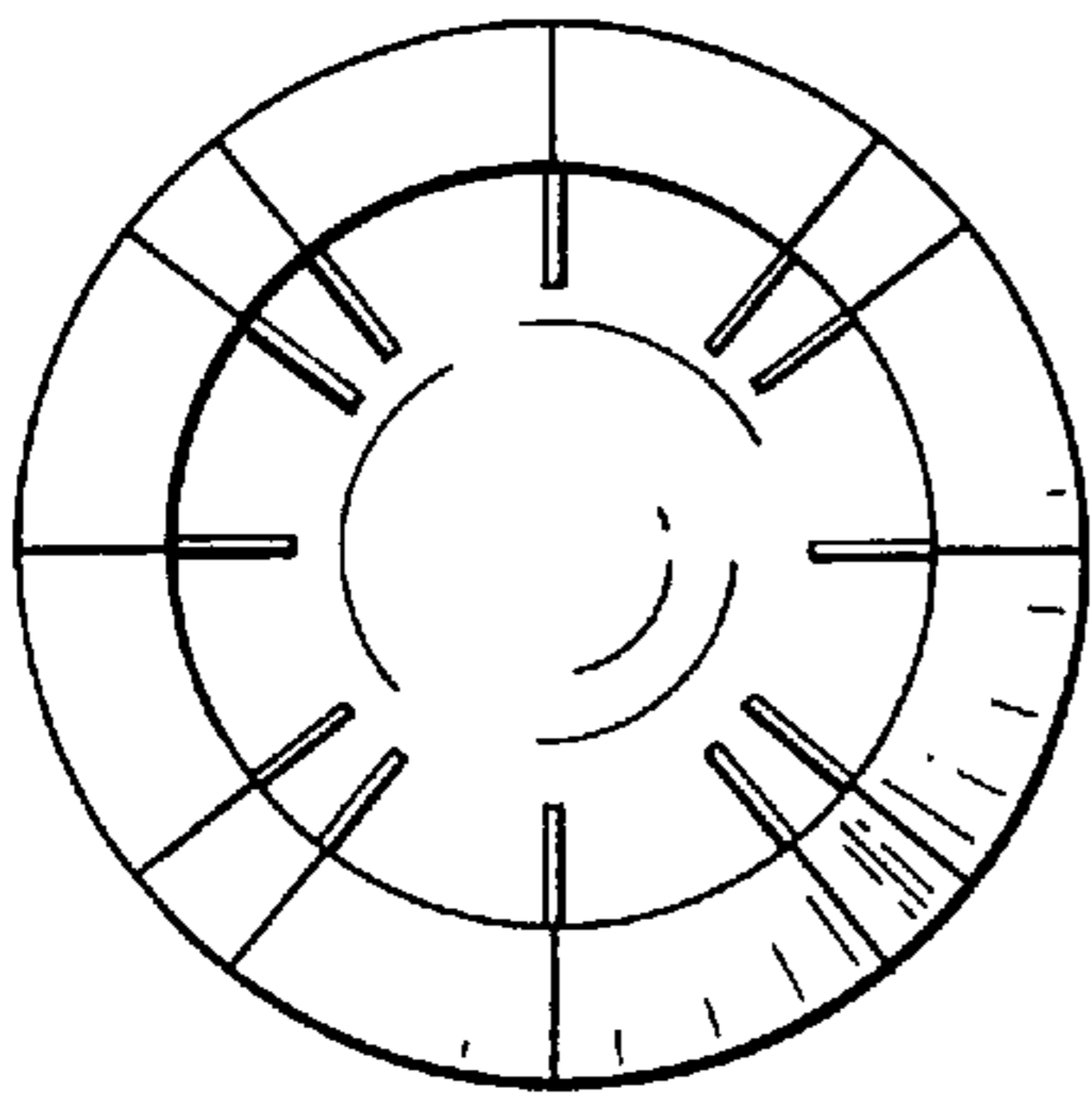

FIG. 35

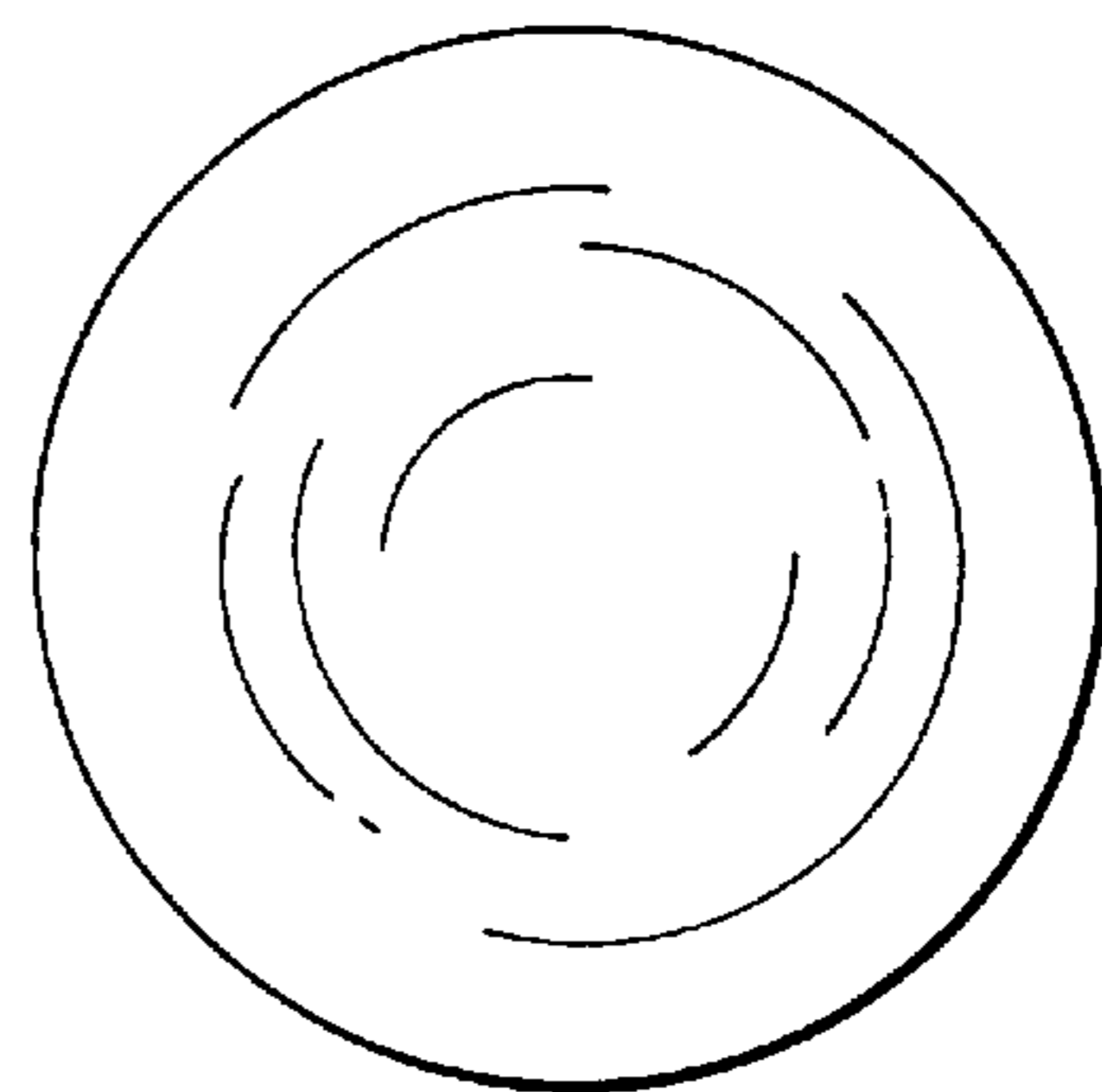

FIG. 36

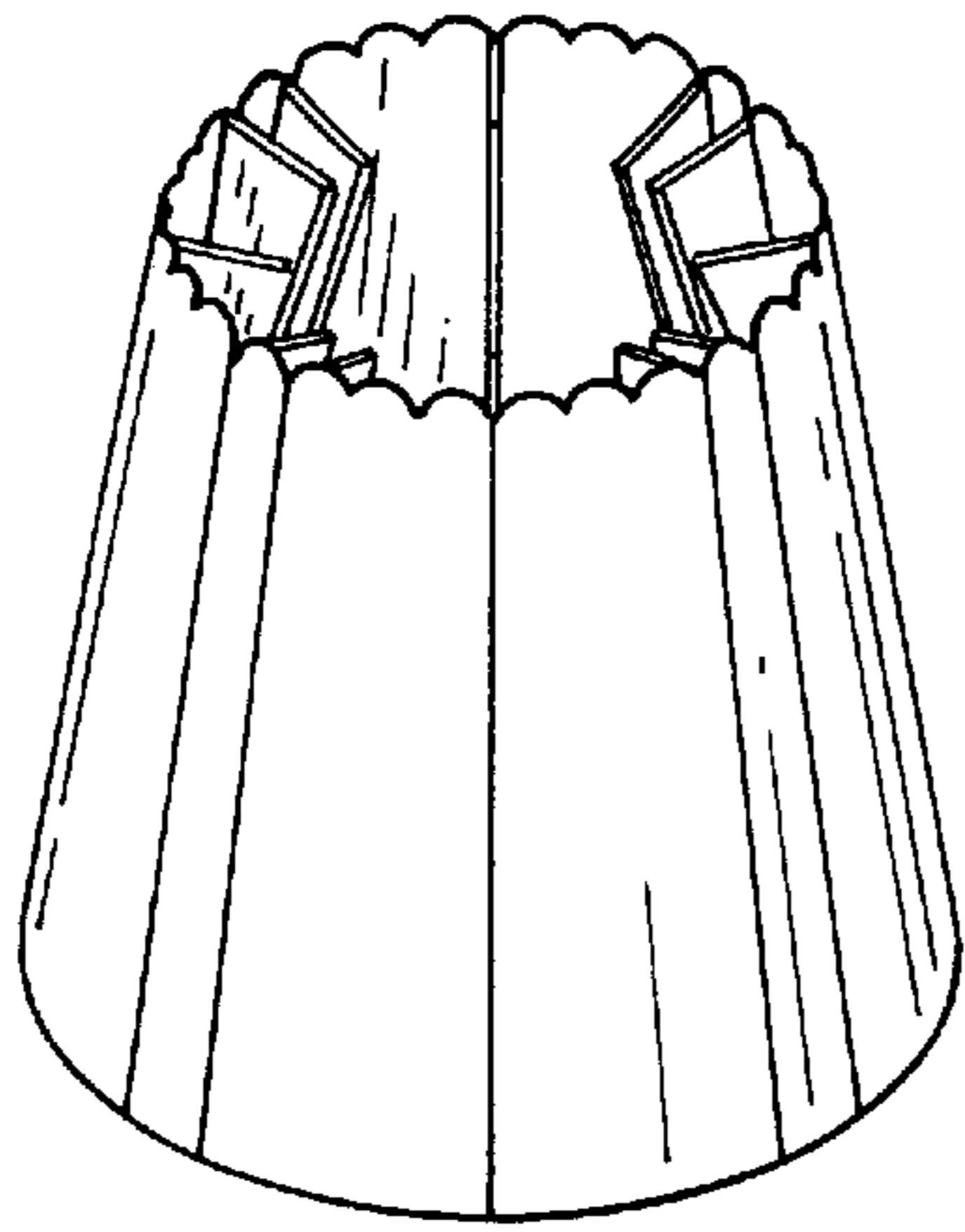

FIG. 37

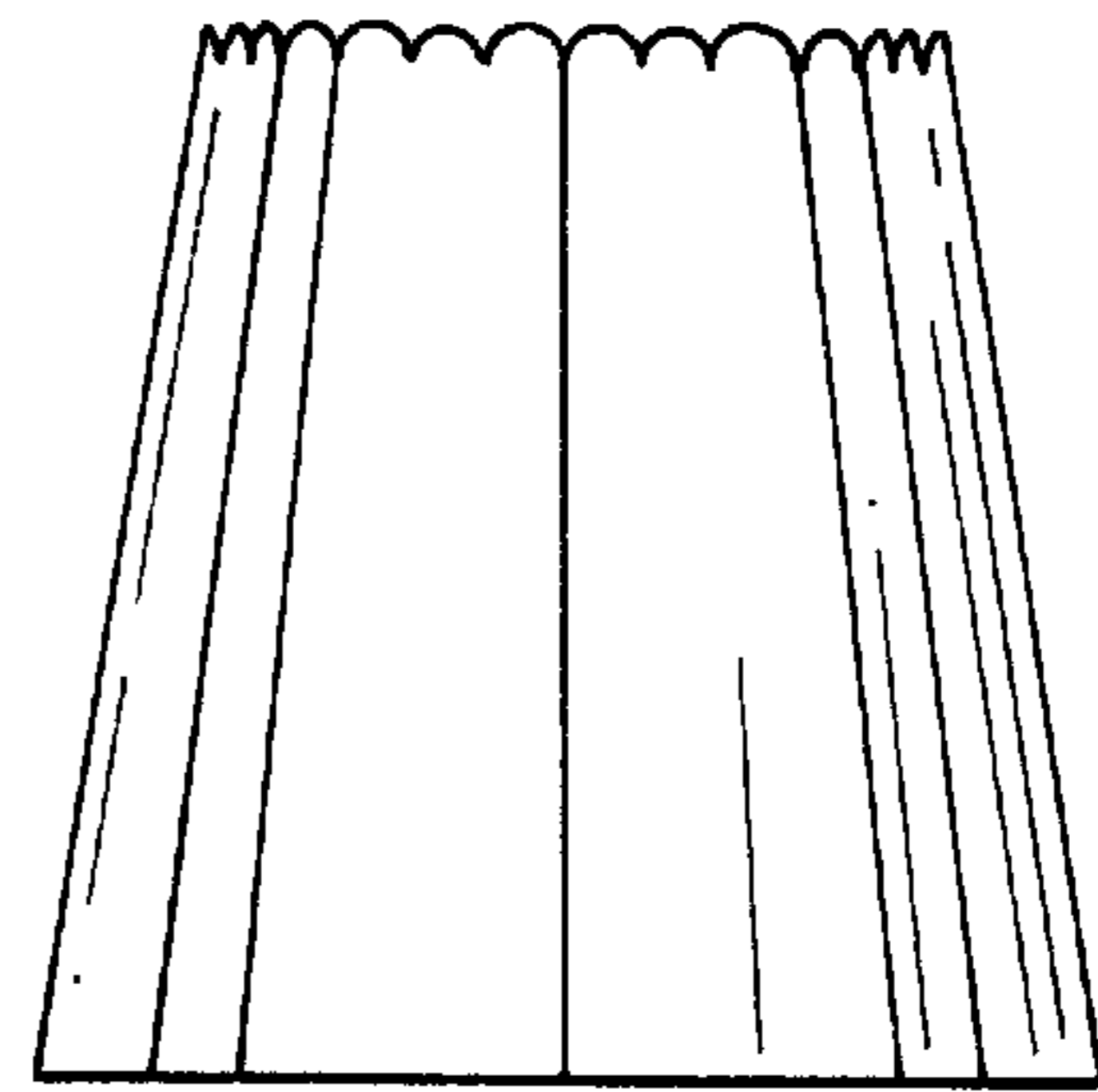

FIG. 38

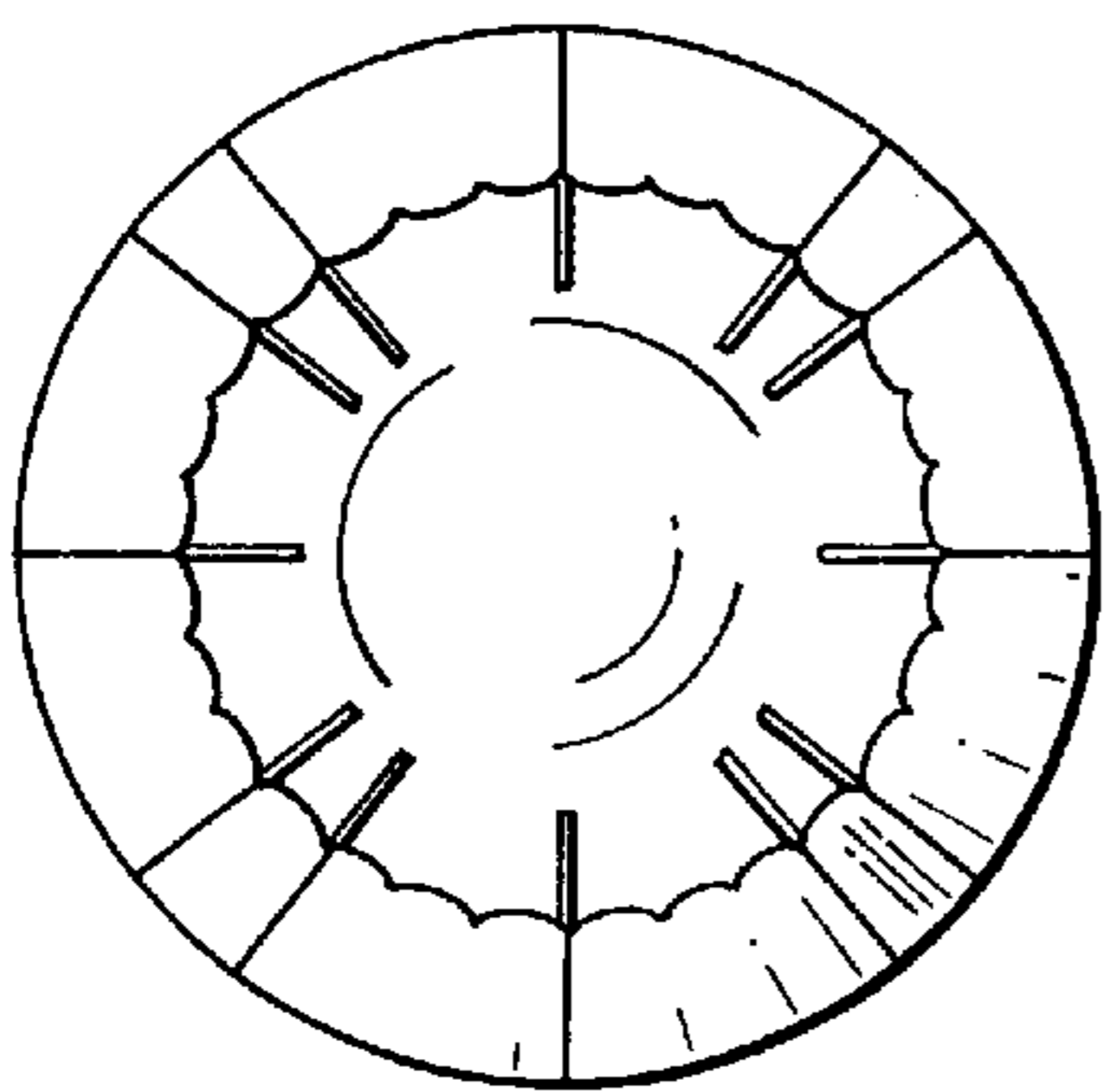

FIG. 39

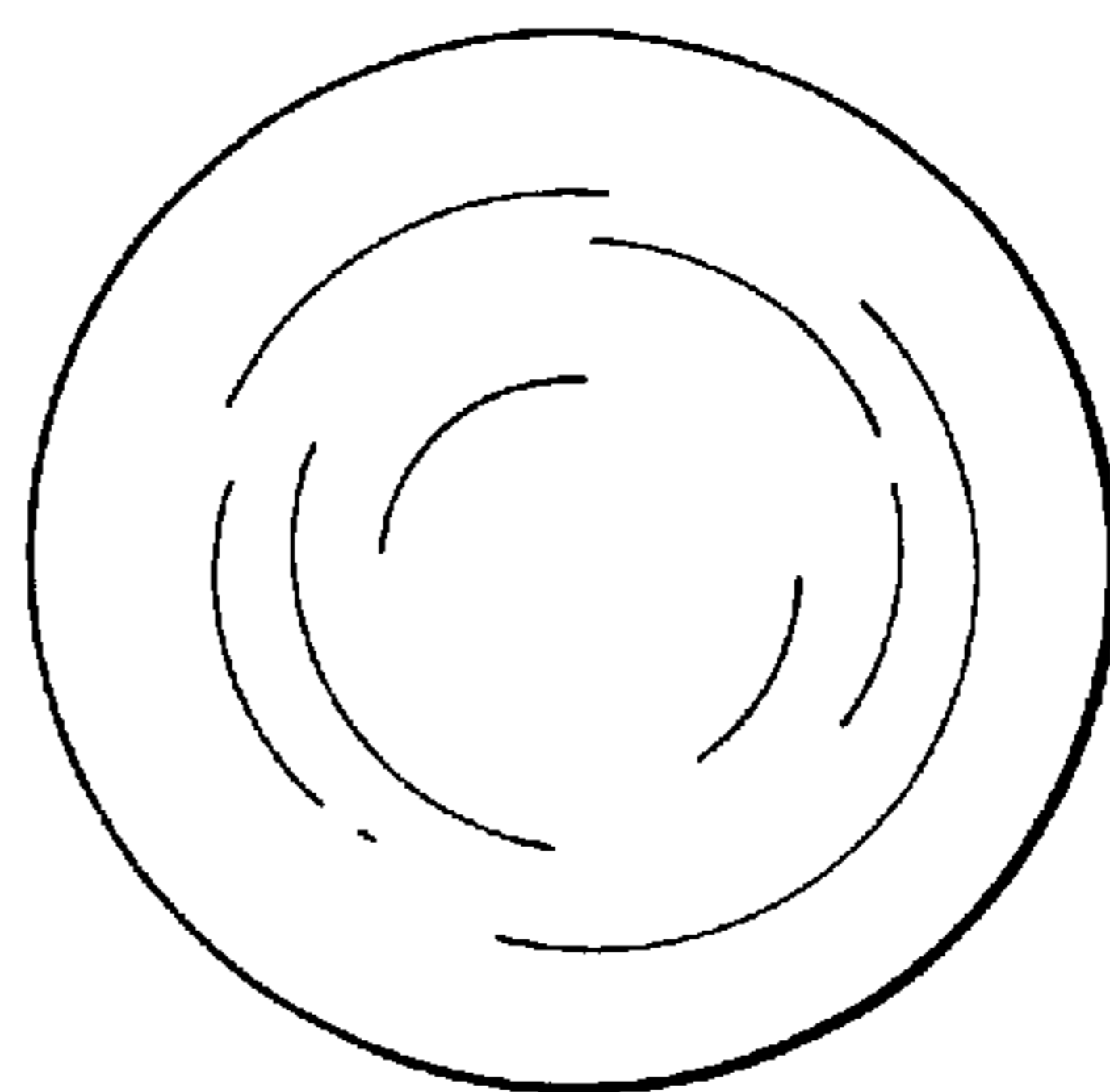

FIG. 40

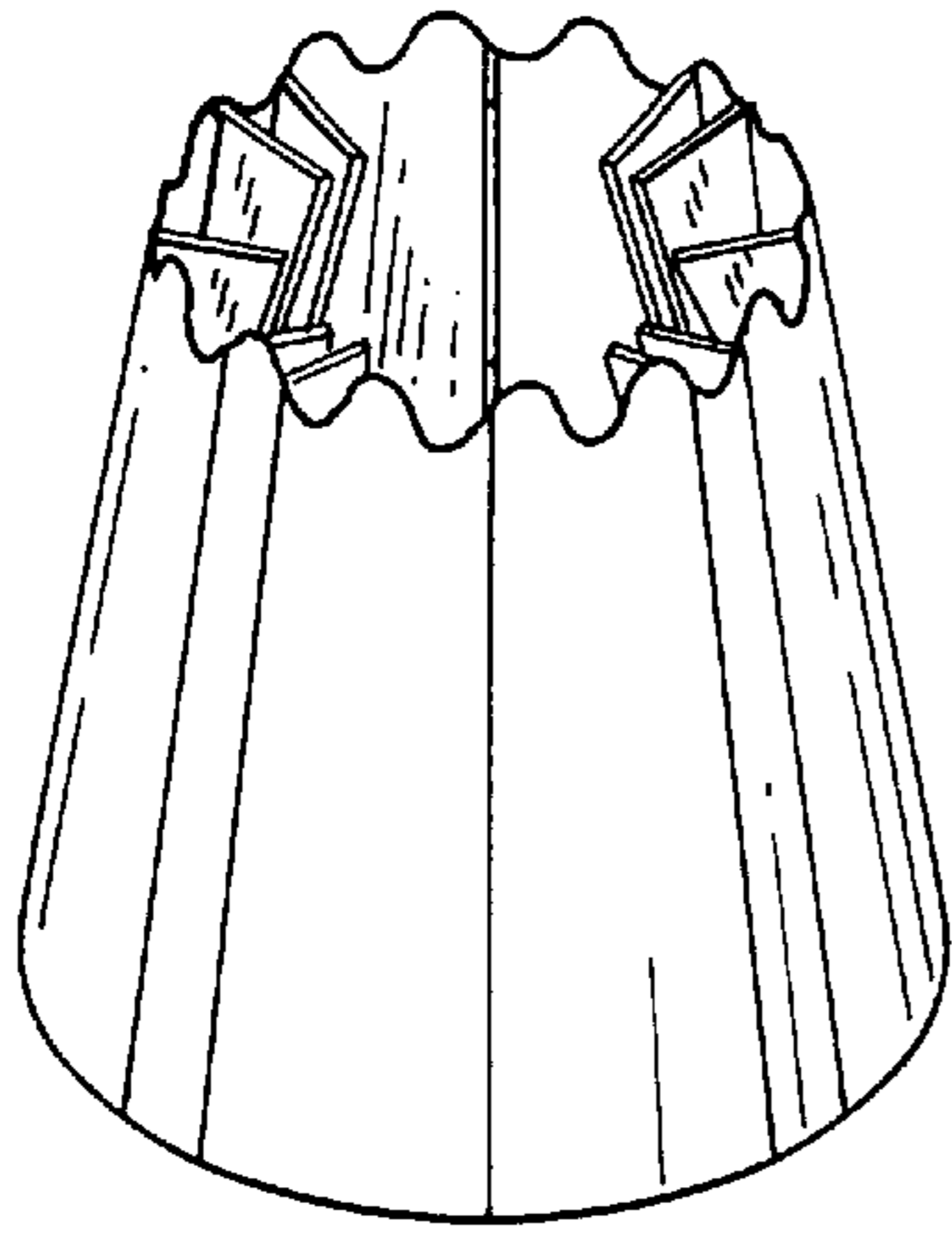

FIG. 41

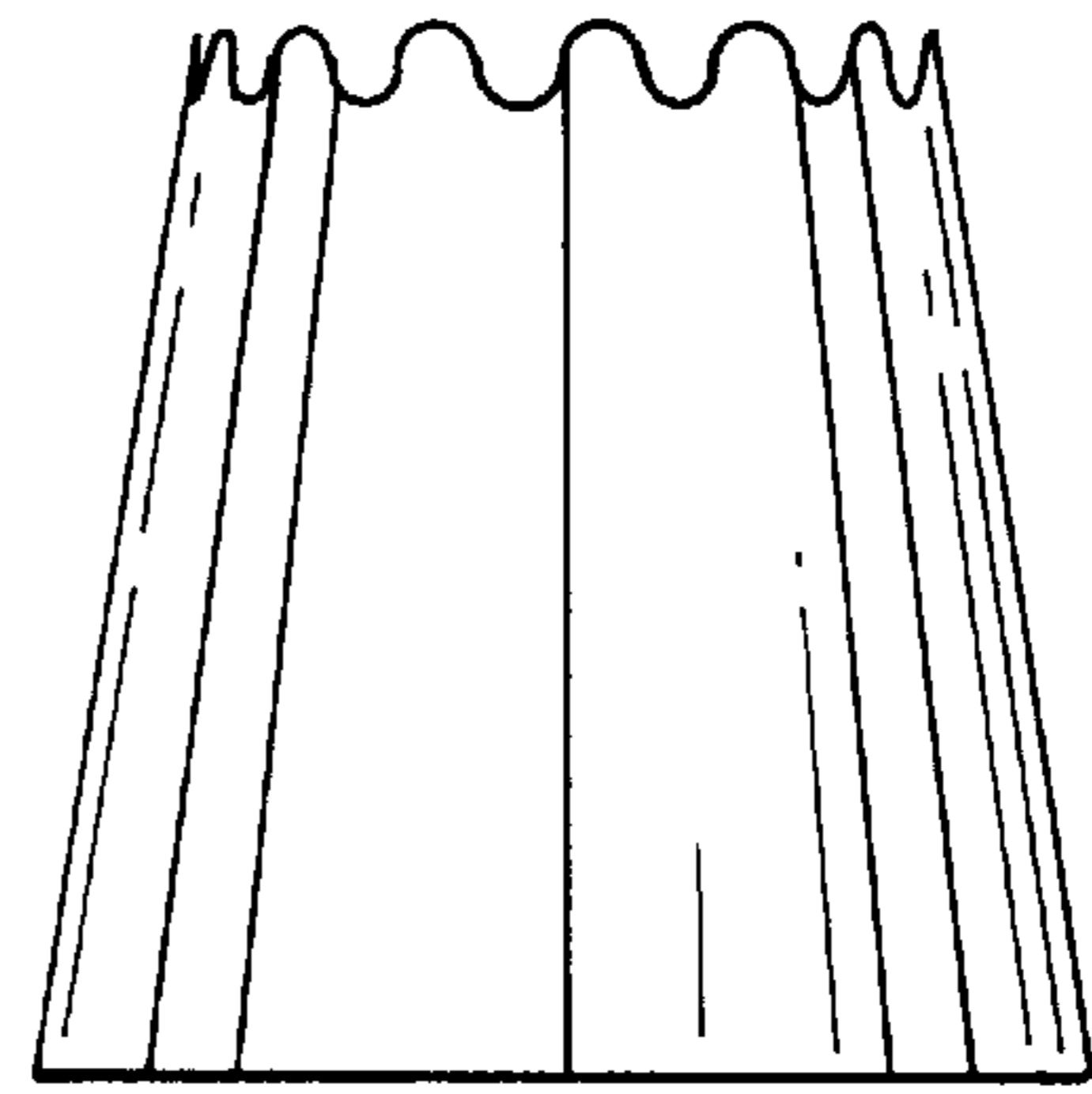

FIG. 42

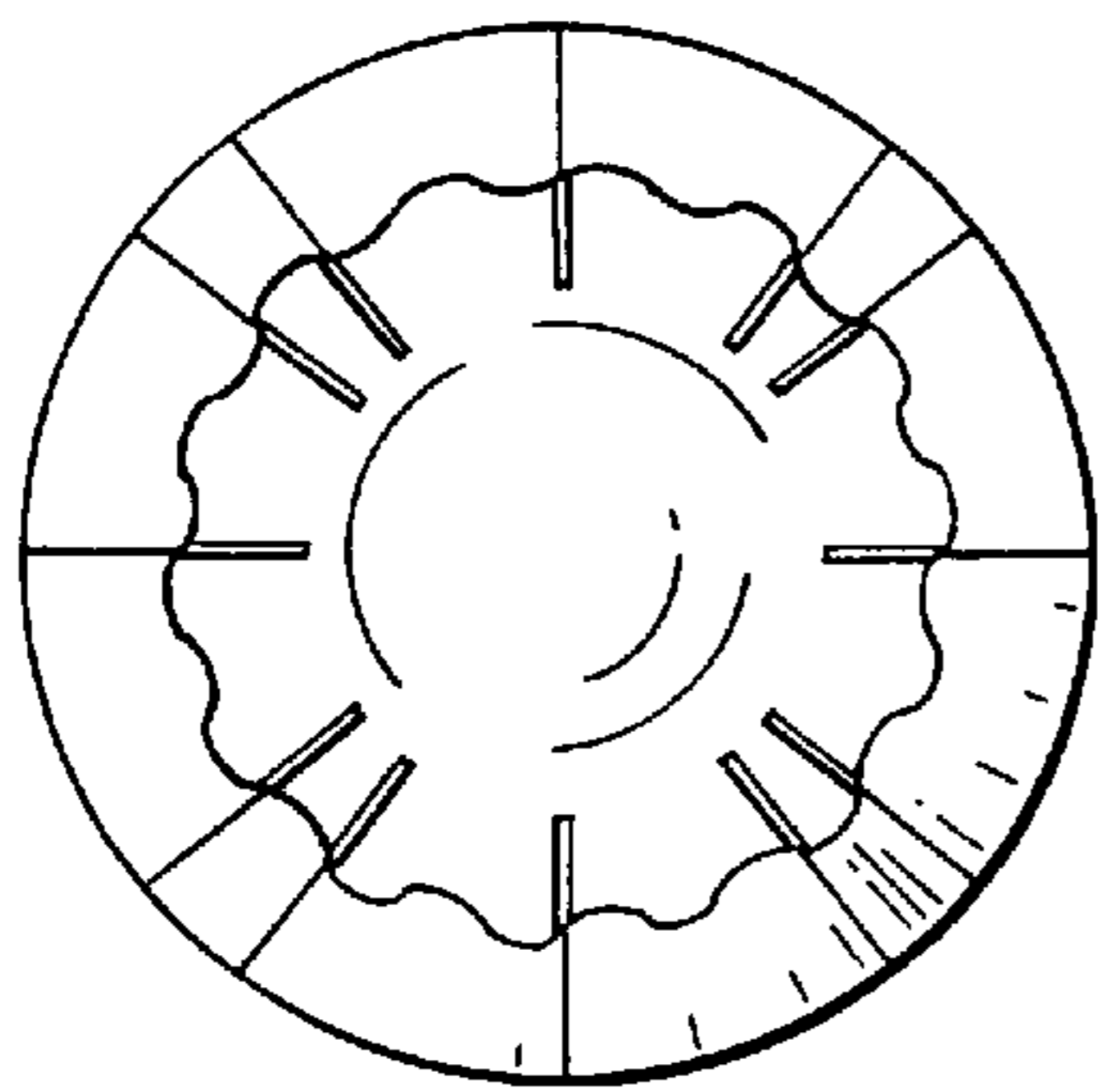

FIG. 43

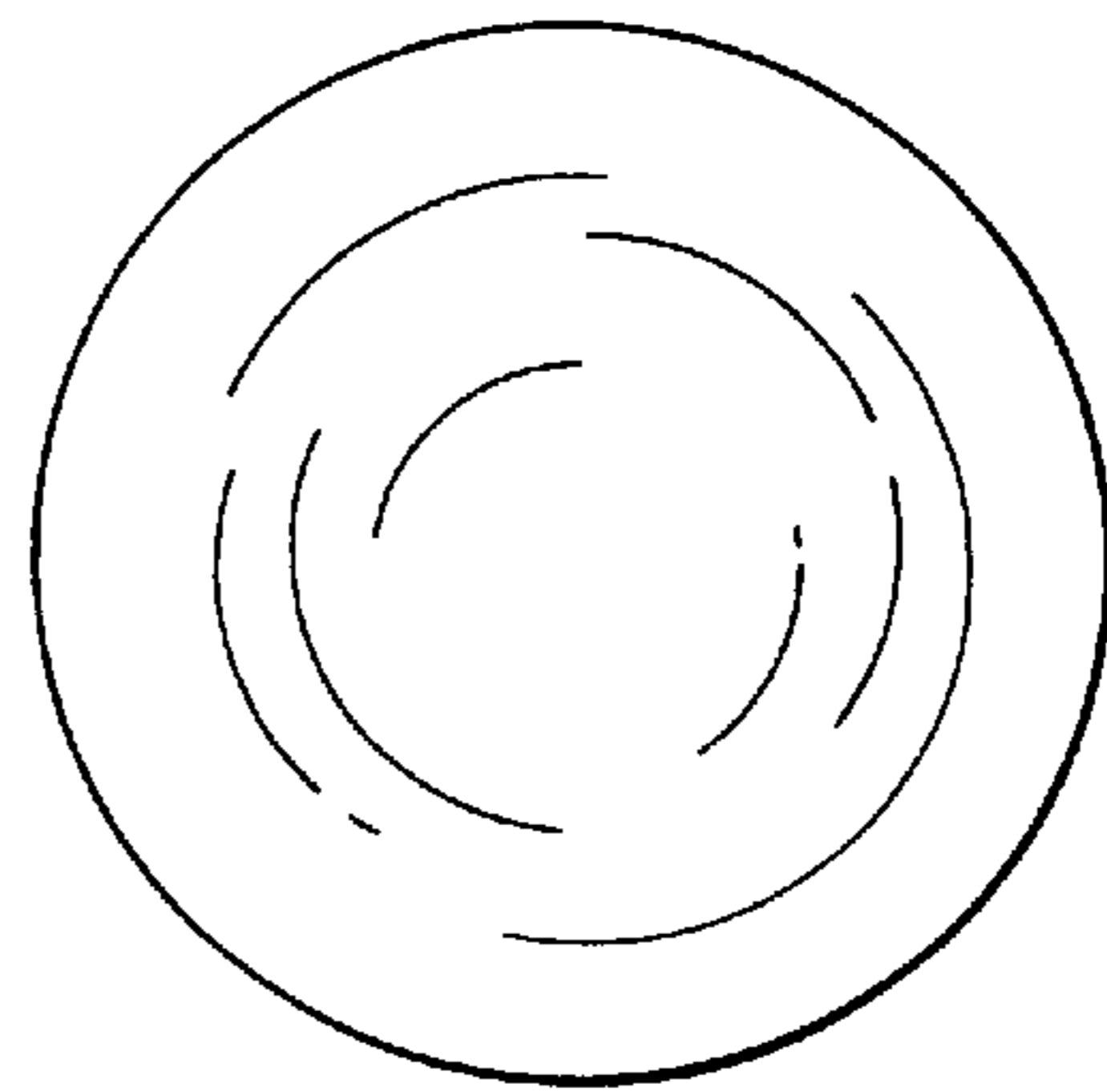

FIG. 44

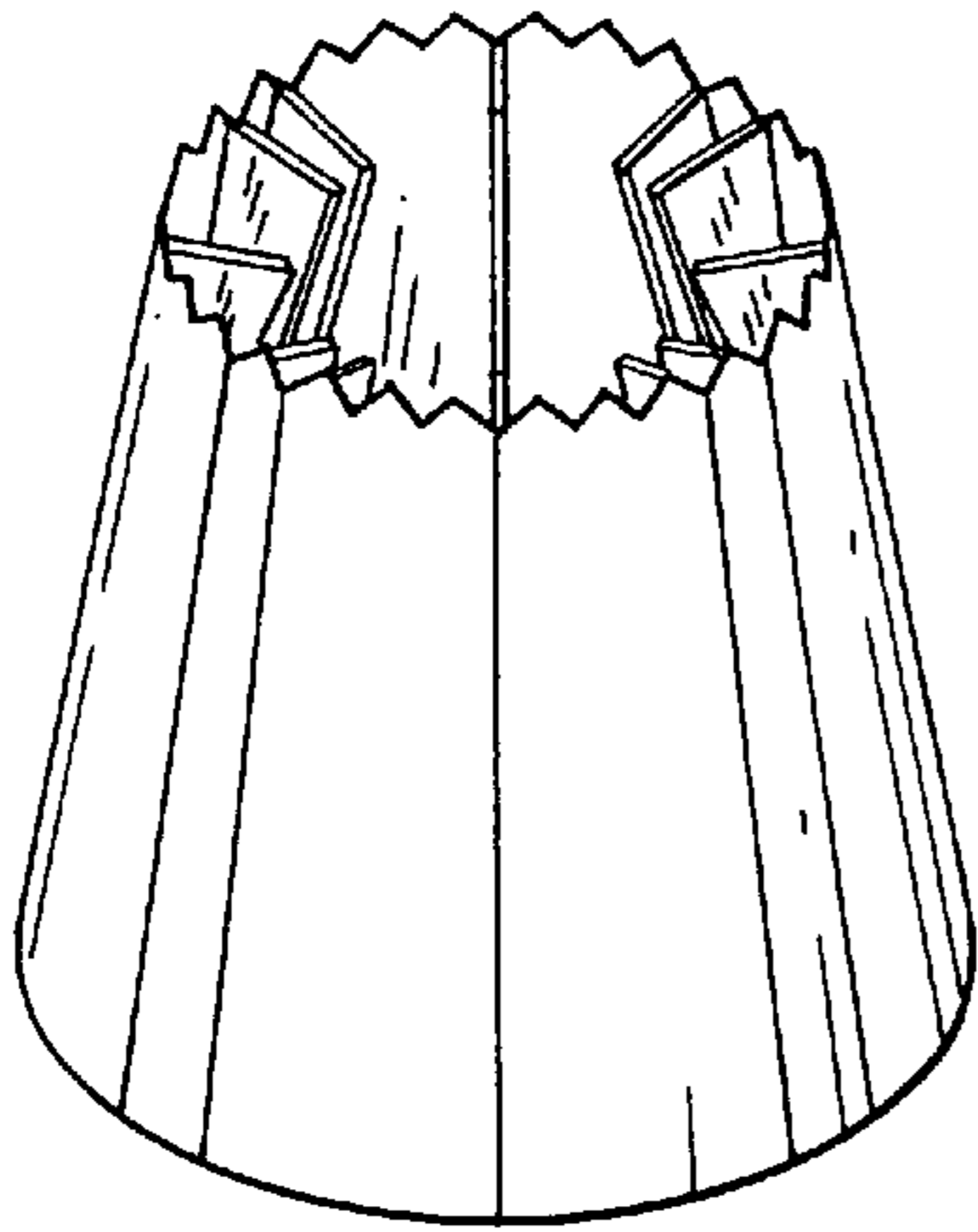

FIG. 45

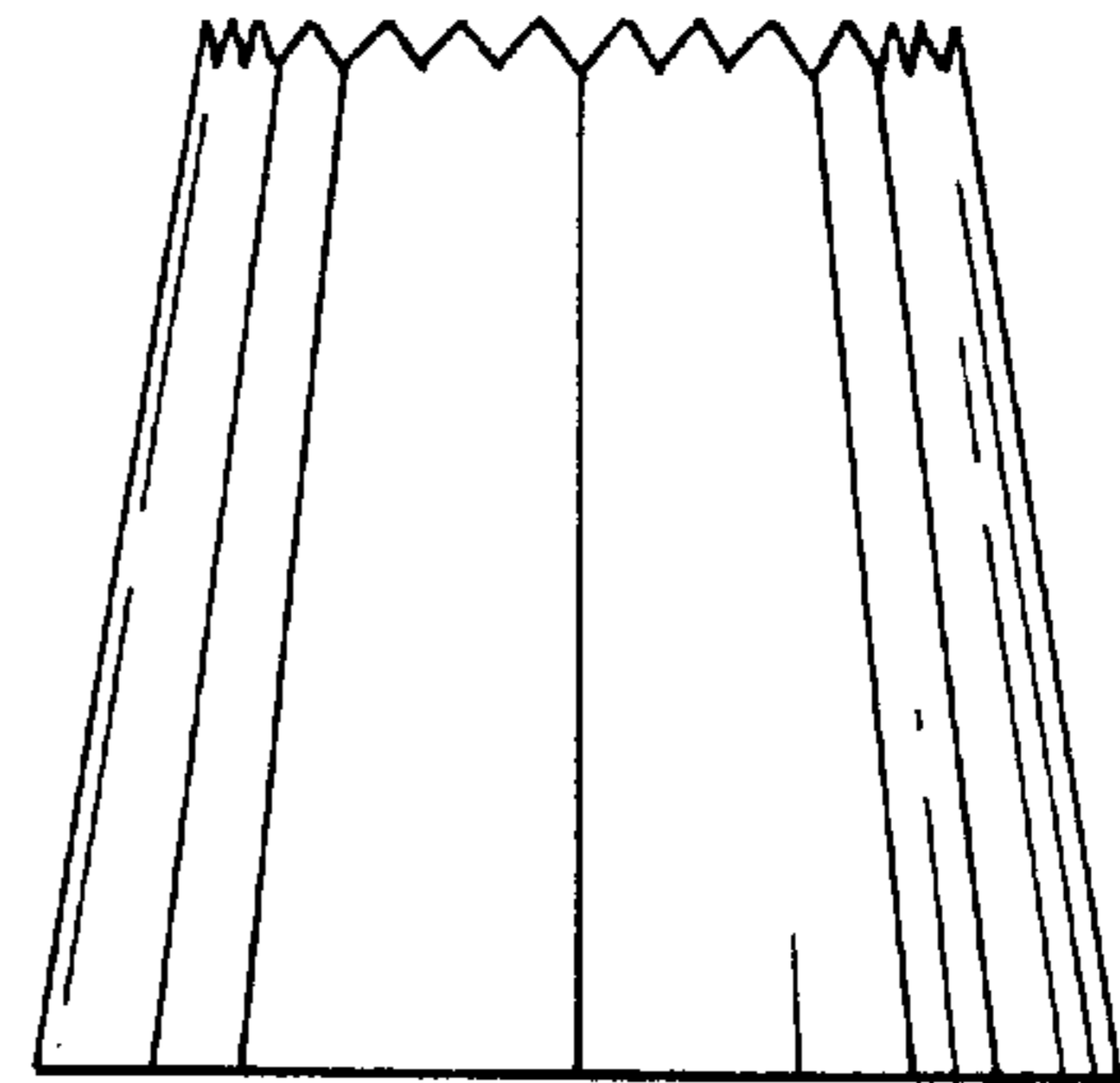

FIG. 46

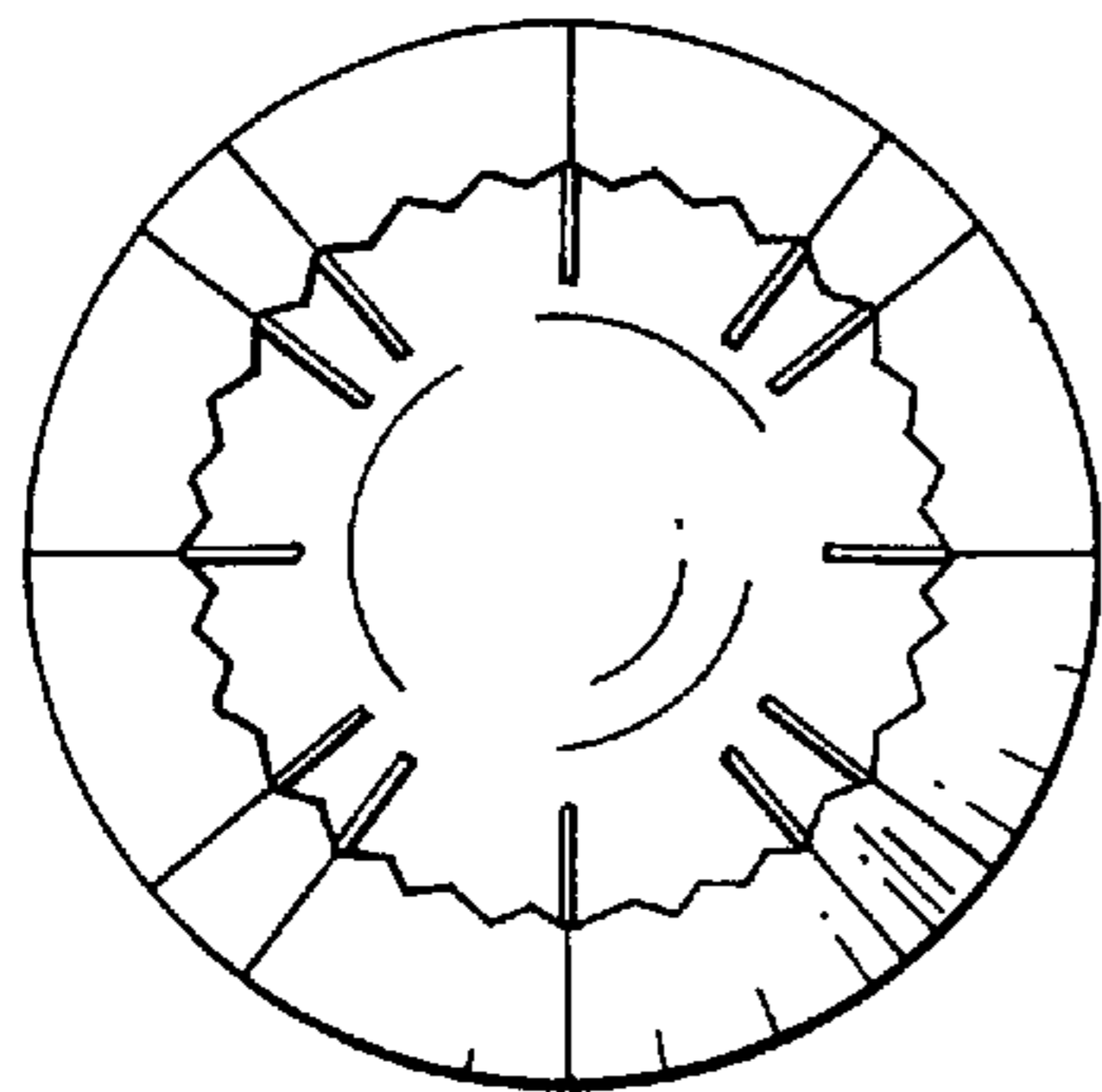

FIG. 47

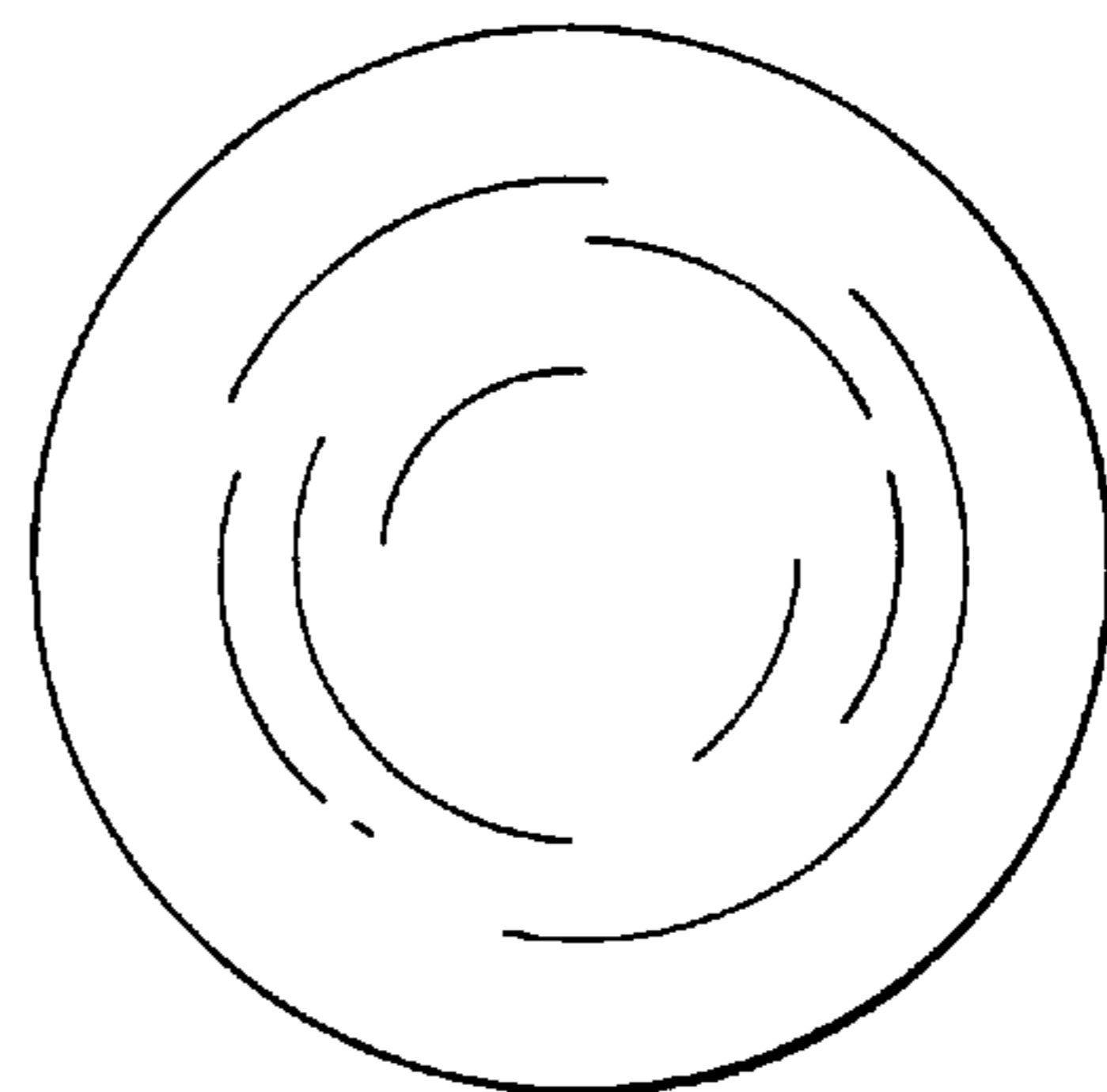

FIG. 48