



US00D399782S

United States Patent [19] Ray

[11] **Patent Number: Des. 399,782**

[45] **Date of Patent: **Oct. 20, 1998**

[54] **HOLDER FOR FLORAL ARRANGEMENTS**

D. 272,329 1/1984 Clemmons, Jr. D11/147
D. 372,640 8/1996 Sinner D11/164 X
2,867,464 1/1959 Crampton D11/156 X

[75] Inventor: **James E. Ray**, Brantford, Canada

[73] Assignee: **Floral Ever Fresh Products Inc.**,
Brantford, Canada

Primary Examiner—Caron D. Veynar
Attorney, Agent, or Firm—R. Craig Armstrong

[**] Term: **14 Years**

[57] **CLAIM**

[21] Appl. No.: **76,096**

The ornamental design for a holder for floral arrangements,
as shown.

[22] Filed: **Sep. 2, 1997**

DESCRIPTION

[51] **LOC (6) Cl.** **11-02**

[52] **U.S. Cl.** **D11/143; D11/164**

[58] **Field of Search** D11/143-156,
D11/164; D6/403-405, 556; 47/39, 40,
65, 65.5, 65.7, 67, 68, 71, 72, 41.01, 41.13,
41.15; 206/423, 557, 564; 248/27.8

FIG. 1 is a perspective view of the holder for floral arrange-
ments showing my new design, from above and behind;
FIG. 2 is a top plan view;
FIG. 3 is a rear view;
FIG. 4 is a right side view;
FIG. 5 is a bottom plan view;
FIG. 6 is a front view; and,
FIG. 7 is a left side view.

[56] **References Cited**

U.S. PATENT DOCUMENTS

D. 250,402 11/1978 Connell et al. D11/156

1 Claim, 3 Drawing Sheets

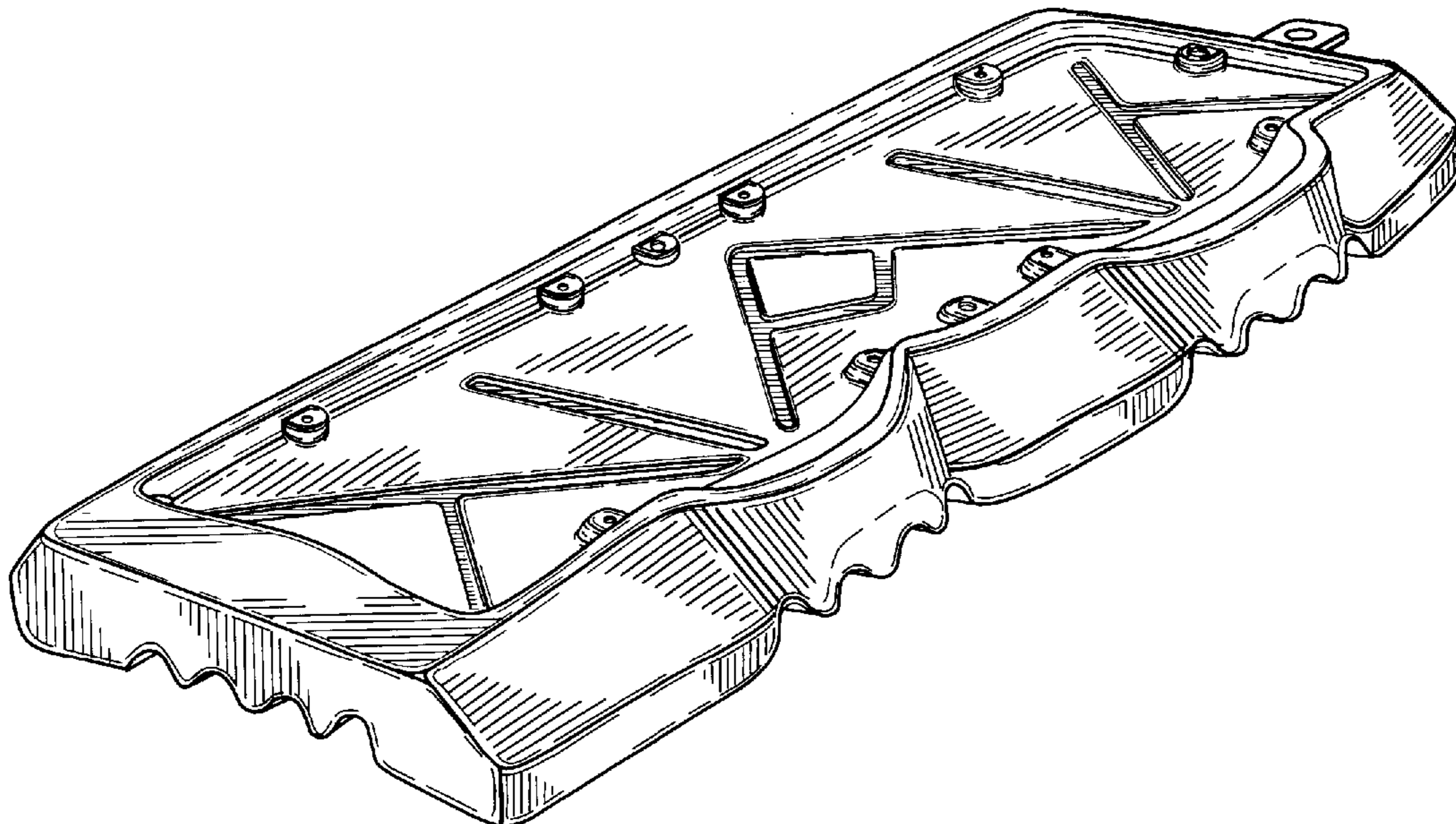

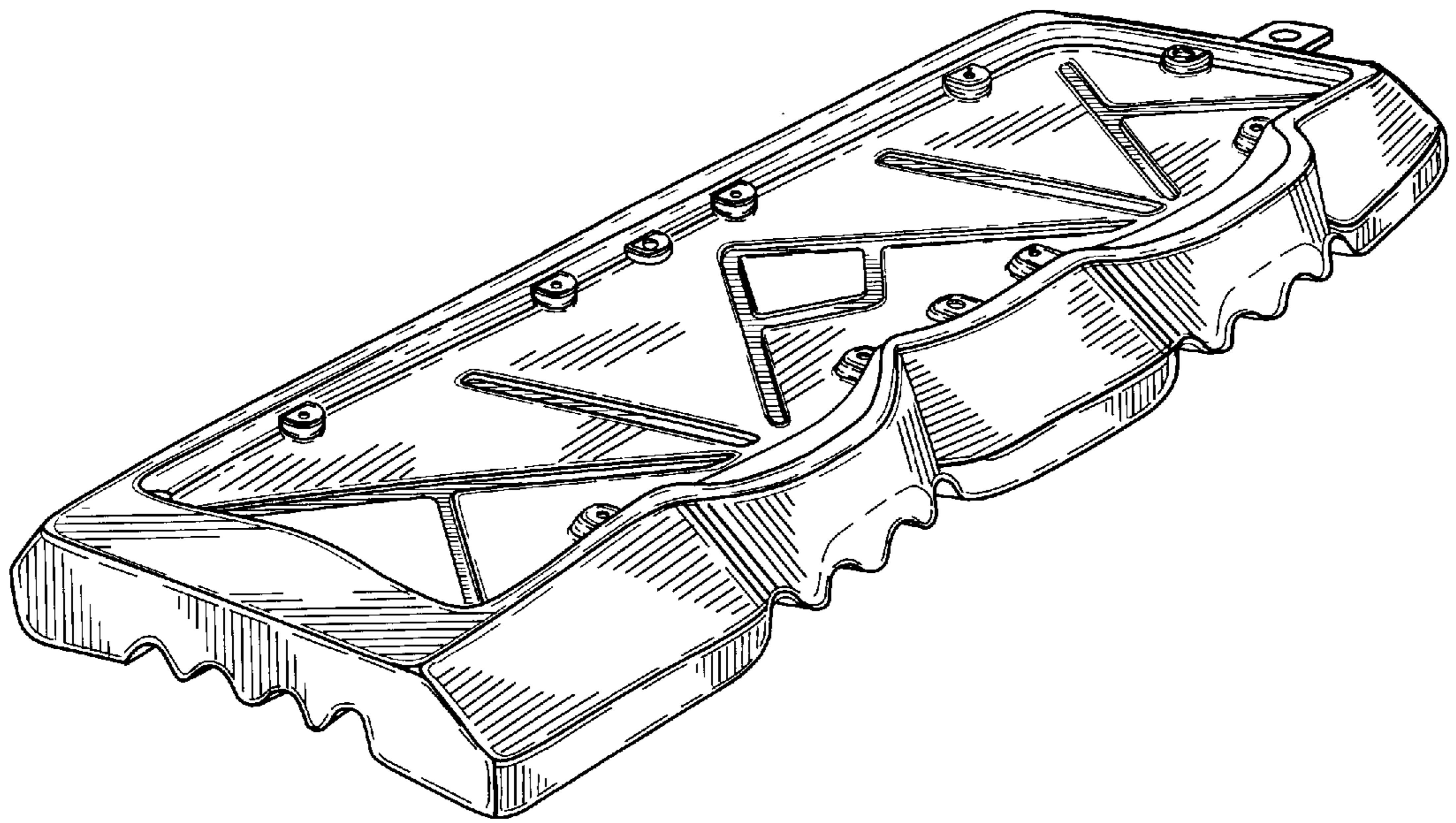

FIG.1

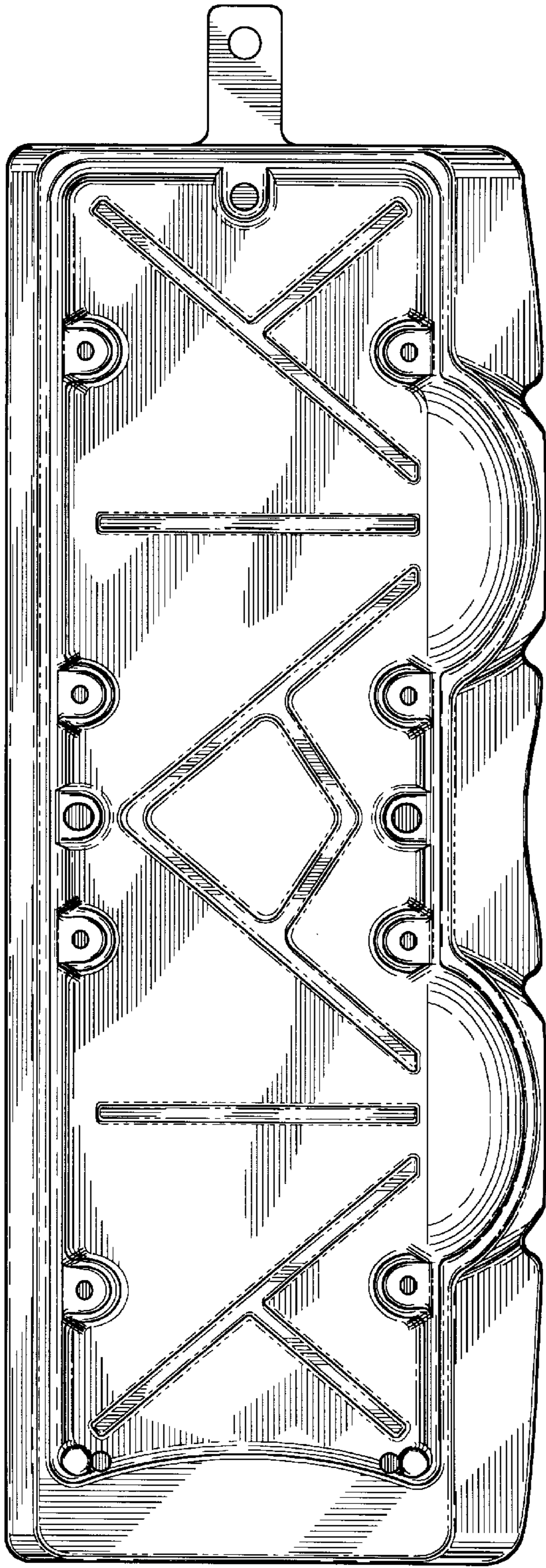

FIG.2

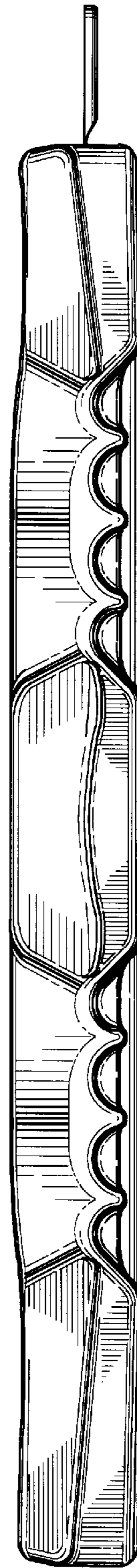

FIG.3

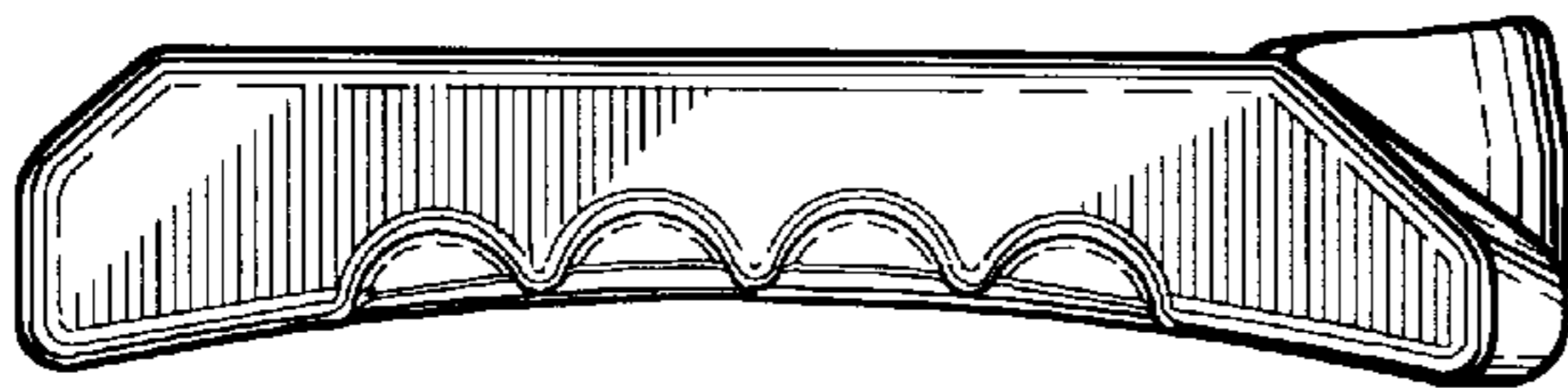

FIG.4

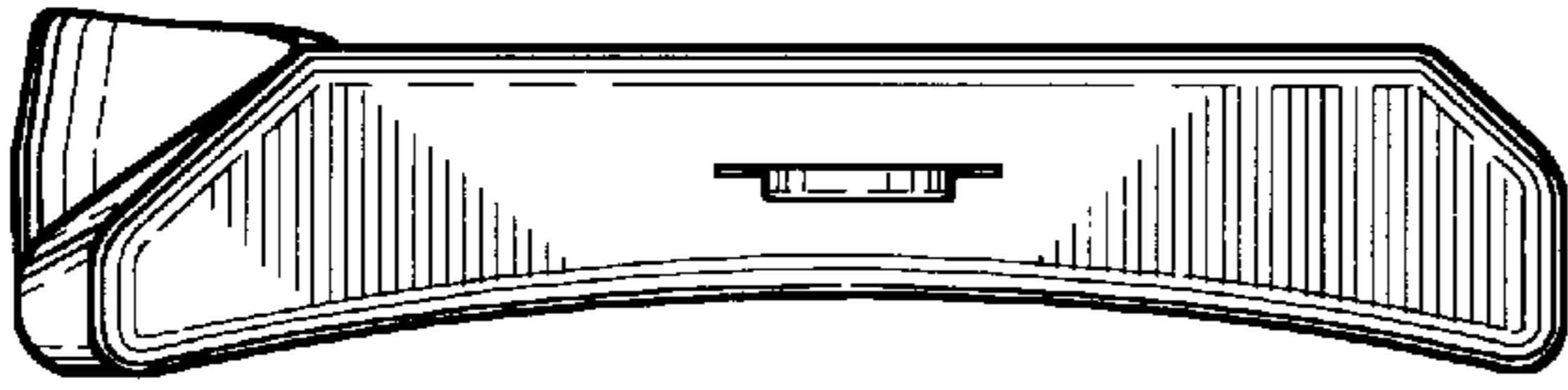

FIG. 7

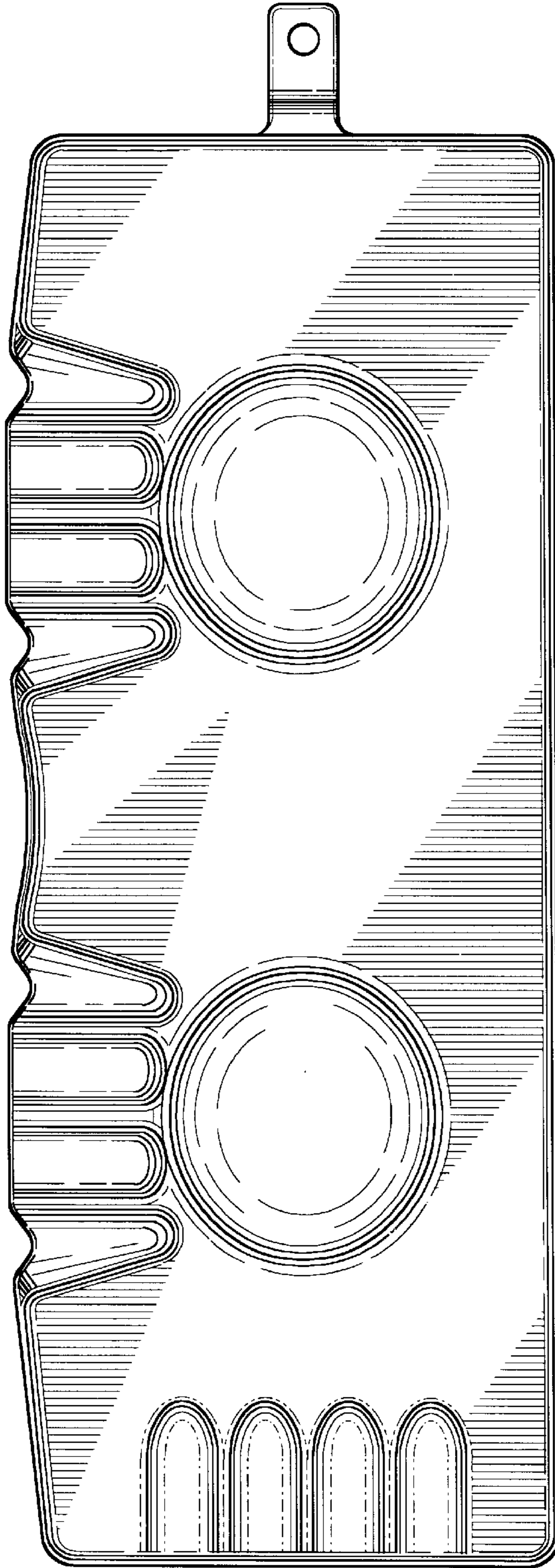

FIG. 5

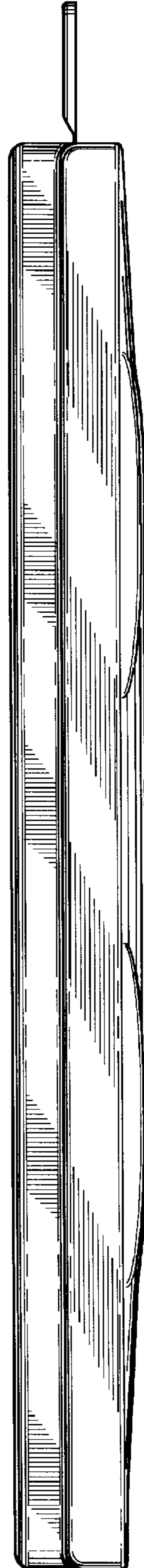

FIG. 6